

**DAIKIN**



# INSTALLATION MANUAL

---

## **VRV** SYSTEM Inverter Air Conditioners

---

MODEL

Ceiling-mounted duct type low static pressure unit

FXDQ07MVJU

FXDQ09MVJU

FXDQ12MVJU

FXDQ18MVJU

FXDQ24MVJU

Read these instructions carefully before installation.  
Keep this manual in a handy place for future reference.  
This manual should be left with the equipment owner.

## CONTENTS





1. SAFETY CONSIDERATIONS .....	1
2. BEFORE INSTALLATION.....	2
3. SELECTING INSTALLATION SITE .....	3
4. PREPARATIONS BEFORE INSTALLATION .....	4
5. INDOOR UNIT INSTALLATION.....	5
6. REFRIGERANT PIPING WORK .....	6
7. DRAIN PIPING WORK.....	7
8. INSTALLING THE DUCT .....	9
9. ELECTRIC WIRING WORK.....	9
10. WIRING EXAMPLE.....	10
11. FIELD SETTING AND TEST RUN .....	12

### 1. SAFETY CONSIDERATIONS

Please read these "SAFETY CONSIDERATIONS" carefully before installing air conditioning equipment and be sure to install it correctly. After completing the installation, make sure that the unit operates properly during the start-up operation. Please instruct the customer on how to operate the unit and keep it maintained.

Also, inform customers that they should store this installation manual along with the operation manual for future reference. This air conditioner comes under the term "appliances not accessible to the general public".

Meaning of danger, warning, caution and note symbols.

-  **DANGER** .....Indicates an imminently hazardous situation which, if not avoided, will result in death or serious injury.
-  **WARNING** .....Indicates a potentially hazardous situation which, if not avoided, could result in death or serious injury.
-  **CAUTION** .....Indicates a potentially hazardous situation which, if not avoided, may result in minor or moderate injury. It may also be used to alert against unsafe practices.
-  **NOTE** .....Indicates situation that may result in equipment or property-damage-only accidents.

#### **DANGER**

- **Refrigerant gas is heavier than air and displaces oxygen. A massive leak could led to oxygen depletion, especially in basements, and an asphyxiation hazard could occur leading to serious injury or death.**
- **Do not install unit in an area where flammable materials are present due to risk of explosion resulting in serious injury or death.**
- **If the refrigerant gas leaks during installation, ventilate the area immediately.**  
Refrigerant gas may produce toxic gas if it comes in contact with fire such as from a fan heater, stove or cooking device. Exposure to this gas could cause severe injury or death.
- **After completing the installation work, check that the refrigerant gas does not leak.**

Refrigerant gas may produce toxic gas if it comes in contact with fire such as from a fan, heater, stove or cooking device. Exposure to this gas could cause severe injury or death.

- **Do not ground units to water pipes, telephone wires or lightning rods because incomplete grounding could cause a severe shock hazard resulting in severe injury or death, and to gas pipes because a gas leak could result in an explosion which could lead to severe injury or death.**
- **Safely dispose of the packing materials.**  
Packing materials, such as nails and other metal or wooden parts, may cause stabs or other injuries. Tear apart and throw away plastic packaging bags so that children will not play with them. Children playing with plastic bags face the danger of death by suffocation.

#### **WARNING**

- **Ask your dealer or qualified personnel to carry out installation work. Do not try to install the machine by yourself.**  
Improper installation may result in water leakage, electric shocks or fire.
- **Perform installation work in accordance with this installation manual.**  
Improper installation may result in water leakage, electric shocks or fire.
- **Be sure to use only the specified accessories and parts for installation work.**  
Failure to use the specified parts may result in water leakage, electric shocks, fire or the unit falling.
- **Install the air conditioner on a foundation strong enough to withstand the weight of the unit.**  
A foundation of insufficient strength may result in the equipment falling and causing injuries.
- **Carry out the specified installation work after taking into account strong winds, typhoons or earthquakes.**  
Improper installation work may result in the equipment falling and causing accidents.
- **Make sure that a separate power supply circuit is provided for this unit and that all electrical work is carried out by qualified personnel according to local laws and regulations and this installation manual.**  
An insufficient power supply capacity or improper electrical construction may lead to electric shocks or fire.
- **Make sure that all wiring is secured, the specified wires are used, and no external forces act on the terminal connections or wires.**  
Improper connections or installation may result in fire.
- **When wiring the power supply and connecting the remote controller wiring and transmission wiring, position the wires so that the electric parts box lid can be securely fastened.**  
Improper positioning of the electric parts box lid may result in electric shocks, fire or the terminals overheating.
- **Before touching electrical parts, turn off the unit.**
- **Be sure to establish an earth.**  
Do not earth the unit to a utility pipe, arrester, or telephone earth.  
Incomplete earth may cause electrical shock, or fire.

A high surge current from lightning or other sources may cause damage to the air conditioner.

- **Do not touch the switch with wet fingers.**  
Touching a switch with wet fingers can cause electric shock.
- **Be sure to install an earth leakage breaker.**  
Failure to install an earth leakage breaker may result in electric shocks, or fire.
- **Do not install the air conditioner in the following locations:**
  - (a) where a mineral oil mist or an oil spray or vapor is produced, for example in a kitchen  
Plastic parts may deteriorate and fall off or result in water leakage.
  - (b) where corrosive gas, such as sulfurous acid gas, is produced  
Corroding copper pipes or soldered parts may result in refrigerant leakage.
  - (c) near machinery emitting electromagnetic waves  
Electromagnetic waves may disturb the operation of the control system and result in a malfunction of the equipment.
- **Heat exchanger fins are sharp enough to cut.**  
To avoid injury wear gloves or cover the fins when working around them.
- **Use of unspecified parts could lead to the unit falling, leaks and, in worse cases, electric shock or fire.**
- **Entrust installation to the place of purchase or a qualified serviceman.**  
Improper installation could lead to leaks and, in worse cases, electric shock or fire.
- **Refrigerant pipes may be very hot or very cold during or immediately after operation.**  
Touching them could result in burns or frostbite. To avoid injury give the pipes time to return to normal temperature or, if you must touch them, be sure to wear proper gloves.

---

### CAUTION

- **While following the instructions in this installation manual, install drain piping in order to ensure proper drainage and insulate piping in order to prevent condensation.**  
Improper drain piping may result in water leakage and property damage.
- **Be very careful about product transportation.**  
Some products use PP bands for packaging. Do not use any PP bands for a means of transportation. It is dangerous.
- **Do not turn off the power immediately after stopping operation.**  
Always wait at least five minutes before turning off the power. Otherwise, water leakage and trouble may occur.
- **Make sure to provide for adequate measures in order to prevent that the outdoor unit be used as a shelter by small animals.**  
Small animals making contact with electrical parts can cause malfunctions, smoke or fire. Please instruct the customer to keep the area around the unit clean.

---

### NOTE

- **Install the indoor and outdoor units, power supply wiring and connecting wires at least 3.5ft. away from televisions or radios in order to prevent image interference or noise.**  
(Depending on the radio waves, a distance of 3.5ft. may not be sufficient enough to eliminate the noise.)

- **Remote controller (wireless kit) transmitting distance can result shorter than expected in rooms with electronic fluorescent lamps. (inverter or rapid start types)**  
Install the indoor unit as far away from fluorescent lamps as possible.
- **Dismantling of the unit, treatment of the refrigerant, oil and eventual other parts, should be done in accordance with the relevant local and national regulations.**

---

## 2. BEFORE INSTALLATION

---

### WARNING

- Entrust installation to the place of purchase or a qualified serviceman. Improper installation could lead to leaks and, in worse cases, electric shock or fire.
- Use of unspecified parts could lead to the unit falling, leaks and, in worse cases, electric shock or fire.

---

### NOTE

- Be sure to read this manual before installing the indoor unit.
- Be sure to mount an air filter (part to be procured in the field) in the suction air passage in order to prevent water leaking, etc.

---

**The accessories needed for installation must be retained in your custody until the installation work is completed. Do not discard them!**

1. Decide upon a line of transport.
2. Leave the unit inside its packaging while moving, until reaching the installation site. Where unpacking is unavoidable, use a sling of soft material or protective plates together with a rope when lifting, to avoid damage or scratches to the unit.

**When moving the unit while removing it from the packing case, be sure to lift it by the four hanger brackets. Avoid putting any pressure on other parts especially the refrigerant piping.**

**Be sure to check the type of R410A refrigerant to be used before installing the unit.**

**(Using an incorrect refrigerant will prevent normal operation of the unit.)**







For the installation of an outdoor unit, refer to the installation manual attached to the outdoor unit.





### 2-1 PRECAUTIONS



- Be sure to instruct customers how to properly operate the unit (operating different functions, and adjusting the temperature ) by having them carry out operations themselves while looking at the operation manual.
- Do not install in locations where the air contains high levels of salt such as that near the ocean and where voltage fluctuates greatly such as that in factories, or in vehicles or vessels.

## 2-2 ACCESSORIES

Check the following accessories are included with your unit.

Name	Metal clamp (1)	Drain hose (2)	Insulation for fitting	Sealing pad
Quantity	1 pc.	1 pc.	1 each	1 each
Shape			 for liquid pipe (3)  for gas pipe (4)	 Large (5)  mid. (6)

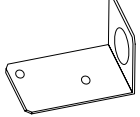
Name	Screws for duct flanges (7)	Washer for hanger bracket (8)	Clamp	Washer fixing plate (11)
Quantity	1 set	8 pcs.	1 set	4 pcs.
Shape	 24 pcs.		 Large (9) 8 pcs.  small (10) 4 pcs.	

Name	Conduit mounting plate	Screw for conduit mounting plate	Insulation tube
Quantity	1 pc.	2 pcs.	1 pc.
Shape			

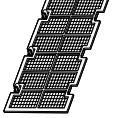
Name	Sealing material (12)	Air filter (13)	(Other)
Quantity	2 pcs.	1 pc.	<ul style="list-style-type: none"> <li>• Operation manual</li> <li>• Installation manual</li> </ul>
Shape			

## 2-3 OPTIONAL ACCESSORIES

- This indoor unit requires one of the operation remote controls listed below.

Remote controller	
Wired type	BRC1C71
Wireless type	BRC4C82

**FOR THE FOLLOWING ITEMS, TAKE SPECIAL CARE DURING CONSTRUCTION AND CHECK AFTER INSTALLATION IS FINISHED.**

### a. Items to be checked after completion of work

Items to be checked	If not properly done, what is likely to occur	Check
Are the indoor and outdoor unit fixed firmly?	The units may drop, vibrate or make noise.	
Is the gas leak test finished?	It may result in insufficient cooling.	
Is the unit fully insulated?	Condensate may drip.	

Does drainage flow smoothly?	Condensate may drip.	
Does the power supply voltage correspond to that shown on the name plate?	The unit may malfunction or the components burn out.	
Are wiring and piping correct?	The unit may malfunction or the components burn out.	
Is the unit safely grounded?	Incomplete grounding may result in electric shocks.	
Is wiring size according to specifications?	The unit may malfunction or the components burn out.	
Is something blocking the air outlet or inlet of either the indoor or outdoor units?	It may result in insufficient cooling.	
Are refrigerant piping length and additional refrigerant charge noted down?	The refrigerant charge in the system is not clear.	

Also review the "SAFETY CONSIDERATIONS".

### b. Items to be checked at time of delivery

Items to be checked	Check
Did you explain about operations while showing the operation manual to your customer?	
Did you hand the operation manual and warranty over to your customer?	
Did you explain about the way of maintaining and cleaning local procurements (air filter, grille (both air outlet and suction grille), etc.) to your customer?	
Did you hand manuals of local procurements (in case equipped) over to your customer?	

## 3. SELECTING INSTALLATION SITE

### ⚠ CAUTION

- When moving the unit while removing it from the packing case, be sure to lift it by the four hanger brackets. Avoid putting any pressure on other parts especially the refrigerant piping.
- If you think the humidity inside the ceiling might exceed 86°F and RH80%, reinforce the insulation on the unit body. Use glass wool or polyethylene foam as insulation so that the thickness is more than 1/2 in. and fits inside the ceiling opening.

### (1) Select an installation site where the following conditions are fulfilled and that meets with your customer's approval.

- Where optimum air distribution can be ensured.
- Where nothing blocks air passage.
- Where condensate can be properly drained.
- Where the ceiling is strong enough to bear the indoor unit weight.
- Where the false ceiling is not noticeably on an incline.
- Where sufficient clearance for maintenance and service can be ensured. (Refer to Fig. 1)
- Where piping between indoor and outdoor units is possible within the allowable limit. (Refer to the installation manual for the outdoor unit.)

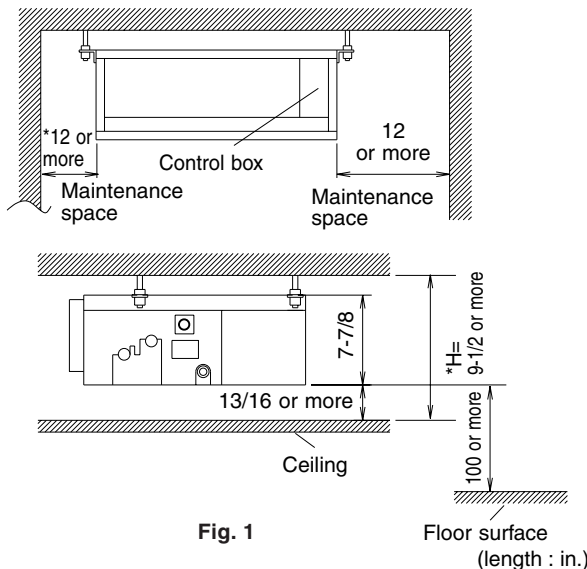

Fig. 1

- Select the \*H dimension such that a downward slope of at least 1/100 is ensured as indicated in "7. DRAIN PIPING WORK".
- The maintenance space marked with "\*" is required when the installation box for adaptor PC board (KRP1B101) sold separately is used.

[ PRECAUTION ]

- Install the indoor and outdoor units, power supply wiring and connecting wires at least 3.3 ft. away from televisions or radios in order to prevent image interference or noise. (Depending on the radio waves, a distance of 3.3 ft. may not be sufficient enough to eliminate the noise.)
- If installing the wireless kit in a room with electronic fluorescent lighting (inverter or rapid start type), the remote controller's transmission distance may be shortened. Indoor units should be installed as far away from fluorescent lighting as possible.

**! DANGER**

- Do not install unit in an area where flammable materials are present due to the risk explosion resulting in serious injury or death.

**! WARNING**

- If the supporting structural members are not strong enough to take the unit's weight, the unit could fall out of place and cause serious injury.

**! NOTE**

- Install the indoor and outdoor units, power supply wiring and connecting wires at least 3.5 ft. away from televisions or radios in order to prevent image interference or noise. (Depending on the radio waves, a distance of 3.5 ft. may not be sufficient enough to eliminate the noise.)

- (2) Use suspension bolts for installation. Check whether the ceiling is strong enough to support the weight of the unit or not. If there is a risk, reinforce the ceiling before installing the unit.

(Installation pitch is marked on the carton box for installation. Refer to it to check for points requiring reinforcing.)

#### 4. PREPARATIONS BEFORE INSTALLATION

- (1) Confirm the positional relationship between the unit and suspension bolts. (Refer to Fig. 2)

- Install the inspection opening on the control box side where maintenance and inspection of the control box and drain pump are easy. Install the inspection opening also in the lower part of the unit.

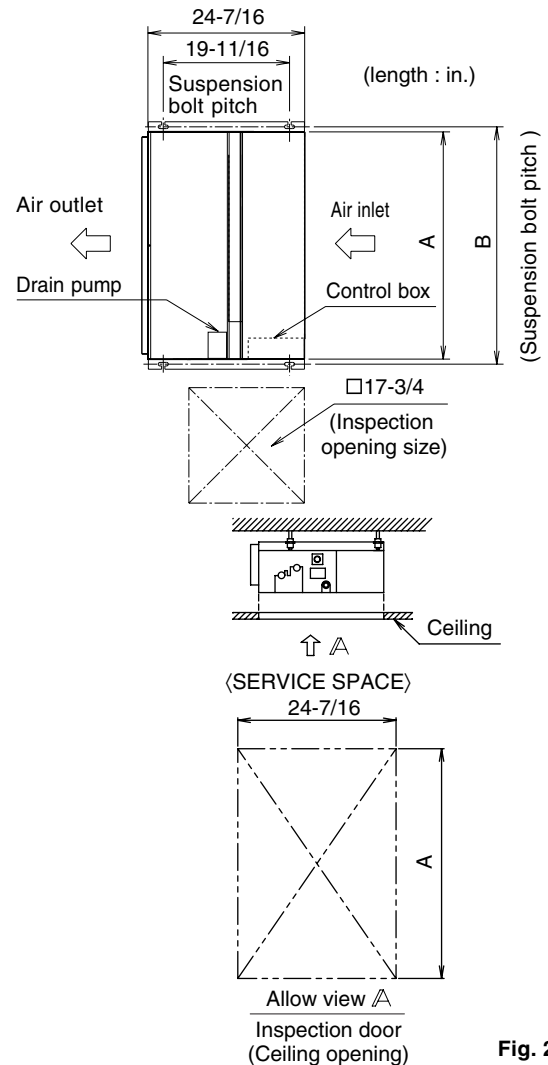

Fig. 2

(length : in.)

Model	A	B
07 · 09 · 12 type	27-9/16	29-1/8
18 type	35-7/16	37
24 type	43-5/16	44-7/8

- (2) Make sure the range of the unit's external static pressure is not exceeded.

(See the Engineering Data for the range of the external static pressure setting.)

**(3) Open the installation hole. (Pre-set ceilings)**

- Once the installation hole is opened in the ceiling where the unit is to be installed, pass refrigerant piping, drain piping, transmission wiring, and remote controller wiring (It is not necessary if using a wireless remote controller) to the unit's piping and wiring holes.

See "6. REFRIGERANT PIPING WORK", "7. DRAIN PIPING WORK", and "10. WIRING EXAMPLE".

- After opening the ceiling hole, make sure ceiling is level if needed. It might be necessary to reinforce the ceiling frame to prevent shaking.

Consult an architect or carpenter for details.

**(4) Install the suspension bolts.**

(Use W3/8 to M10 suspension bolts.)

Use a hole-in-anchor for existing ceilings, and a sunken insert, sunken anchor or other part to be procured in the field to reinforce the ceiling to bearing the weight of the unit for new ceiling. (Refer to Fig. 3)

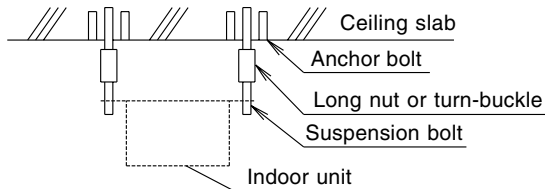

Note: All the above parts are field supplied.

Fig. 3

**(5) For bottom intake, replace the chamber lid in the procedure listed in Fig. 4.**

- Remove the protection net and the chamber lid.
- Refer to Fig. 4 for direction of the protection net and the chamber lid.
- Attach the air filter (accessory) in the manner shown in the diagram.

The four holes which cannot be covered by the air filter should be covered with commercially available tape.

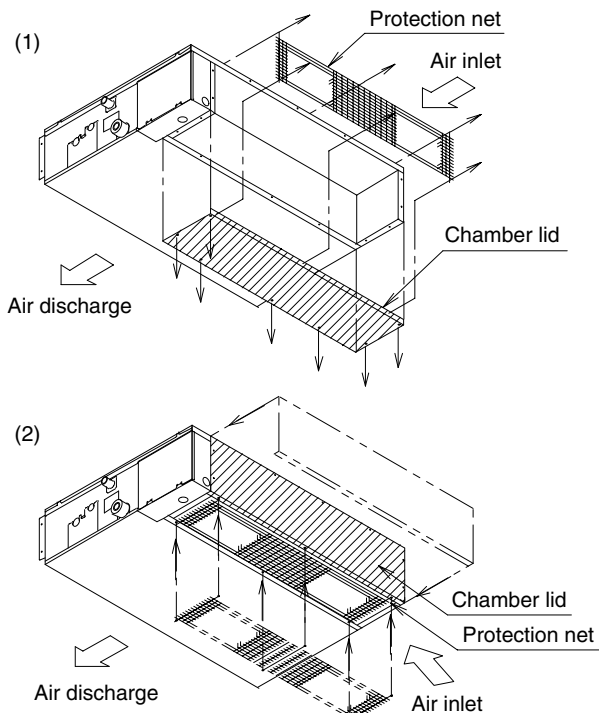
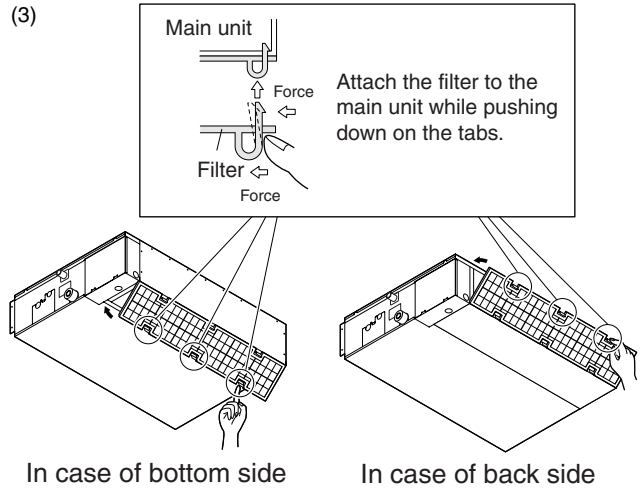

Fig. 4



**5. INDOOR UNIT INSTALLATION**

«As for the parts to be used for installation work, be sure to use the provided accessories and specified parts designated by our company.»

**(1) Install the indoor unit temporarily.**

- Attach the hanger bracket to the suspension bolt. Be sure to fix it securely by using a nut and washer from the upper and lower sides of the hanger bracket. (Refer to Fig. 5)

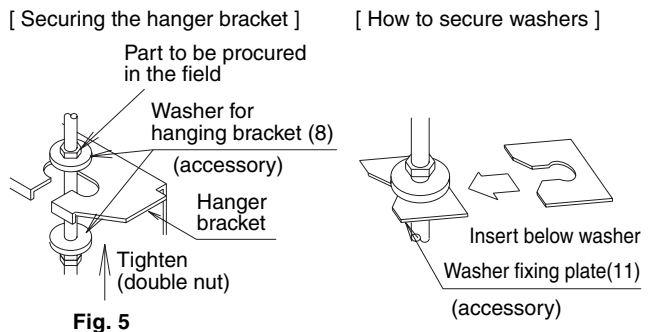

Fig. 5

**[ PRECAUTION ]**

Since the unit uses a plastic drain pan, prevent welding spatter and other foreign substances from the air outlet during installation.

**(2) Adjust the height of the unit.**

**(3) Check if the unit is horizontally level.**

**CAUTION**

- Make sure the unit is installed level using a level or a plastic tube filled with water. In using a plastic tube instead of a level, adjust the top surface of the unit to the surface of the water at both ends of the plastic tube and adjust the unit horizontally. (One thing to watch out for in particular is if the unit is installed so that the slope is not in the direction of the drain piping, this might cause leaking.)

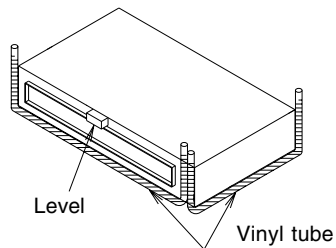

(4) Tighten the upper nut.

## 6. REFRIGERANT PIPING WORK

⟨For refrigerant piping of outdoor units, see the installation manual attached to the outdoor unit.⟩

⟨Execute heat insulation work completely on both sides of the gas piping and the liquid piping. Otherwise, a water leakage can result sometimes.⟩

Use insulation that can withstand temperatures of at least 250°F. Reinforce the insulation on the refrigerant piping according to the installation environment. If the temperature above the ceiling might reach 86°F or the humidity RH80%. Condensation may form on the surface of the insulation.⟩

### CAUTION

Follow the points at below.

- Use a pipe cutter and flare suitable for the type of refrigerant.
- Apply ester oil or ether oil to the flare section when using a flare connection.
- Only use the flare nuts included with the unit. Using different flare nuts may cause the refrigerant to leak.
- To prevent dust, moisture or other foreign matter from infiltrating the piping, either pinch the end or cover it with tape.
- Do not allow anything other than the designated refrigerant to get mixed into the refrigerant circuit, such as air, etc. If any refrigerant gas leaks while working on the unit, ventilate the room thoroughly right away.

### (1) Connect the piping.

- The outdoor unit is charged with refrigerant.
- Be sure to use both a spanner and torque wrench together, as shown in the drawing, when connecting or disconnecting pipes to/from the unit. (Refer to Fig. 6)

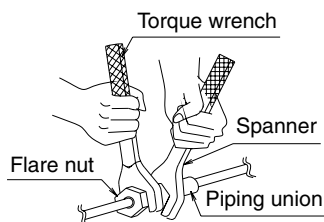

Fig. 6

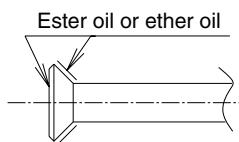

Fig. 7

- Refer to the Table 1 for the dimensions of flare nut spaces.
- Apply ester oil or ether oil to flare section (both inside and out) when using flare nut connections and then turn 3 or 4 times by hand. (Refer to Fig. 7)
- Refer to Table 1 for tightening torque.

Table 1

Pipe size (in.)	Tightening torque (ft.lbf)	Flare dimensions A (in.)	Flare shape (in.)
φ1/4	10.4–12.7	0.342–0.358	
φ3/8	24.1–29.4	0.504–0.520	
φ1/2	36.5–44.5	0.638–0.654	
φ5/8	45.6–55.6	0.760–0.776	

### CAUTION

Overtightening may damage the flare and cause leaks. Be careful for oil not to adhere to any portions other than a flare part. If oil adhere to resin parts etc., there is a possibility of damaging by deterioration.

- Refer to Table 2 if no torque wrench is available. Using a wrench to tighten flare nuts causes the tightening torque to suddenly grow much tighter after a certain point. From there, tighten the nut further by the appropriate angle listed in Table 2.
- (2) After the work is finished, make sure to check that there is no gas leak.
  - (3) After checking for gas leaks, be sure to insulate the pipe connections referring to Fig. 8.
    - Insulate using the insulation for fitting (3) (4) included with the liquid and gas pipes. Besides, make sure the insulation for fitting (3) (4) on the liquid and gas piping has its seams facing up.
    - (Tighten both edges with clamp (9).)
    - For the gas piping, wrap the mid. sealing pad (6) over the insulation for fitting (4) (flare nut part).

Liquid Piping Insulation Procedure

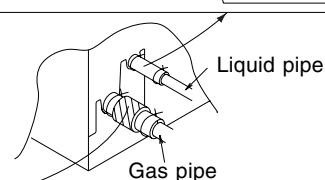
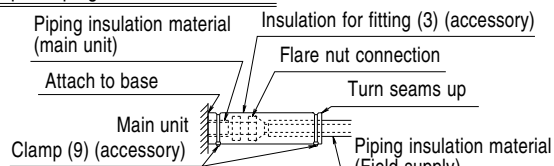

Gas Piping Insulation Procedure

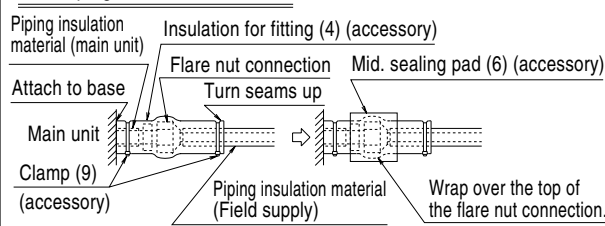

Fig. 8

### CAUTION

Be sure to insulate any field piping all the way to the piping connection inside the unit. Any exposed piping may cause condensation or burns if touched.

- When brazing the refrigerant piping, perform nitrogen replacement first, or perform the brazing (CAUTION 2) while feeding nitrogen into the refrigerant piping (CAUTION 1), and finally connect the indoor unit using the flare connections. (Refer to Fig. 9)

**CAUTION**

- When brazing a pipe while feeding nitrogen inside the pipe, make sure to set the nitrogen pressure to 29 psi or less using the pressure reducing valve. (This pressure is such that breeze is blown to your cheek.)

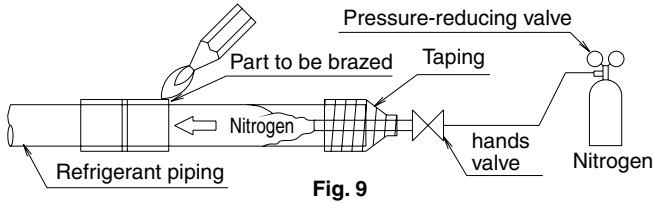

Fig. 9

**Not recommendable but in case of emergency**

You must use a torque wrench but if you are obliged to install the unit without a torque wrench, you may follow the installation method mentioned below.

After the work is finished, make sure to check that there is no gas leak.

When you keep on tightening the flare nut with a spanner, there is a point where the tightening torque suddenly increases. From that position, further tighten the flare nut the angle shown below:

Table 2

Pipe size (in.)	Further tightening angle	Recommended arm length of tool (in.)
φ1/4	60 to 90 degrees	Approx. 5-7/8
φ3/8	60 to 90 degrees	Approx. 7-7/8
φ1/2	30 to 60 degrees	Approx. 9-13/16
φ5/8	30 to 60 degrees	Approx. 11-13/16

**DANGER**

- Use of oxygen could result in an explosion resulting in serious injury or death. Only use nitrogen gas.
- Refrigerant gas may produce toxic gas if it comes in contact with fire such as from a fan heater, stove or cooking device. Exposure to this gas could cause severe injury or death.

**NOTE**

- Do not use flux when brazing refrigerant piping. Therefore, use the phosphor copper brazing filler metal (BCuP) which does not require flux. (Flux has an extremely negative effect on refrigerant piping systems. For instance, if chlorine based flux is used, it will cause pipe corrosion. Flux containing fluorine will damage refrigerant oil.)

## 7. DRAIN PIPING WORK

**CAUTION**

- The connection opening on the drain piping may vary depending on the model, so check the model name and use the right method for that model.
- Make sure all water is out before making the duct connection.

**(1) Install the drain piping.**

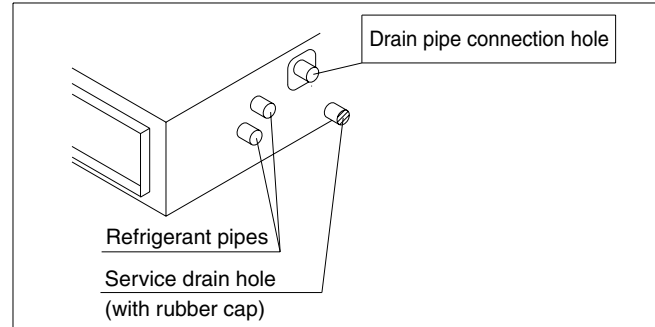

- Make sure the drain works properly.
- The diameter of the drain piping should be greater than or equal to the diameter of the connecting pipe (vinyl tube; pipe size : 25/32 in. ; outer dimension : 1-1/32 in.). (not including a riser)
- Keep the drain piping short and sloping downwards at a gradient of at least 1/100 to prevent air pockets from forming. (Refer to Fig. 10)

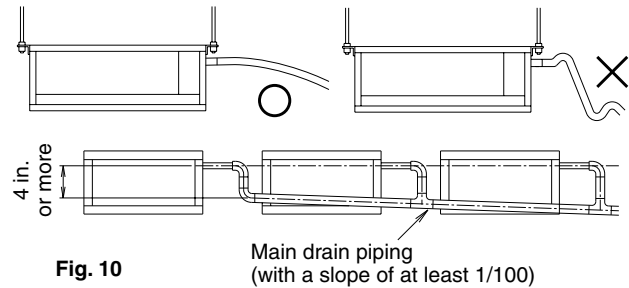

Fig. 10

**CAUTION**

Water accumulating in the drain piping can cause the drain to clog.

- To keep the drain piping from sagging, space hanging bracket every 3 to 5 ft..
- Use the drain hose (2) and the metal clamp (1). Insert the drain hose (2) fully into the drain pipe connection hole and firmly tighten the metal clamp (1) with the upper part of the tape on the hose end. Tighten the metal clamp (1) until the screw head is less than 1/8 in. from the hose. (Refer to Fig. 11, 12)
- The two areas below should be insulated because condensation may form there causing water to leak.
  - Drain piping passing indoors
  - Drain pipe connection hole
 Referring the figure below, insulate the metal clamp (1) and drain hose (2) using the included large sealing pad (5). (Refer to Fig. 12)



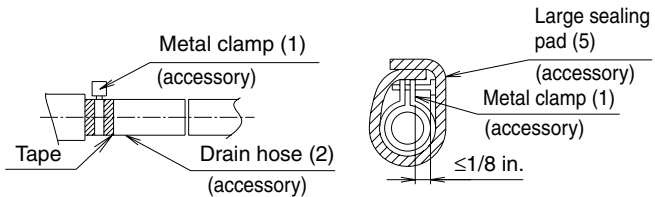

Fig. 11

Fig. 12

< **PRECAUTIONS FOR DRAIN RAISING PIPE** >

- Make sure the drain raising pipe height is no higher than 23-5/8 in..
- Place the drain raising pipe vertically and make sure it is no further than 11-3/4 in. from the unit. **(Refer to Fig. 13)**

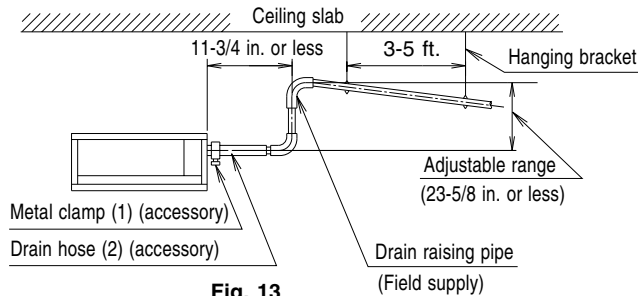

Fig. 13

< **PRECAUTIONS** >

Drain piping connections

- Do not connect the drain piping directly to sewage pipes that smell of ammonia. The ammonia in the sewage might enter the indoor unit through the drain piping and corrode the heat exchanger.
- Do not twist or bend the drain hose (2), so that excessive force is not applied to it. (This type of treatment may cause leaking.)
- If you are using central drain piping, follow the procedure outlined in the figure 10.
- Select central drain piping of proper size according to the capacity of the connected unit.

**(2) After piping work is finished, check drainage flows smoothly.**

- Gradually insert approximately 1 L of water into the drain pan to check drainage in the manner described below.

**CAUTION**

- The electric wiring work shall be performed by qualified electricians.
- If workers not having the electrician qualification have performed the electric wiring work, the steps 3 to 7 shall be performed after the **TEST RUN**.

1. Remove the lid of the control box. Connect the remote controller and power supply (single-phase, 60Hz 208-230V) respectively to the terminal block and securely connect the ground also. (as shown in the figure below).

**CAUTION**

Securely clamp the cables with the clamps (9)(10) offered as accessories as shown in Fig. 14 so that tension will not be applied on the cable connection areas.

2. Confirm that the lid of the control box is closed before turning on the power.
3. Remove the inspection lid.
4. Gradually pour approximately 1 L of water from the water inlet into the drain pan to check drainage.

**CAUTION**

Be sure to prevent an external force from being exerted on the float switch. (This may cause breakage.)

5. Attach the inspection lid.
6. Perform the following operation using the remote controller, and check drainage.

- Select the inspection/test operation button “” using the remote controller. The unit will engage the test operation. Press the operation selector button “”, and select FAN OPERATION “”.
- Press the ON/OFF button “”. (The indoor fan and drain pump will operate.)

**CAUTION**

The fan will turn also at the same time. Take due care. Do not touch the drain pump to prevent electric shock.

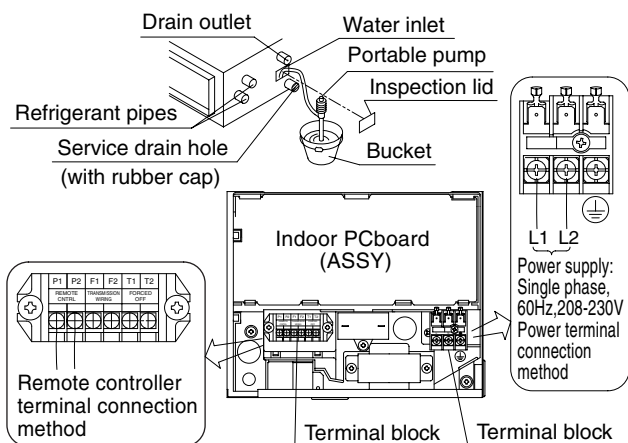

7. Make sure to use the remote controller in finishing the operation.

## 8. INSTALLING THE DUCT

Connect the duct supplied in the field.

### Air inlet side

- Attach the duct and intake-side flange (field supply).
- Connect the flange to the main unit with accessory screws (in 20 or 24 positions).
- Wrap the intake-side flange and duct connection area with aluminum tape or something similar to prevent air escaping.

### CAUTION

When attaching a duct to the intake side, be sure to attach an air filter inside the air passage on the intake side. (Use an air filter whose dust collecting efficiency is at least 50% in a gravimetric technique.)

The included filter is not used when the intake duct is attached.

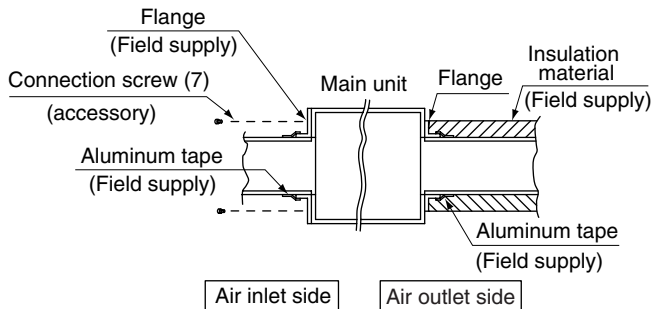

### Air outlet side

- Connect the duct according to the air inside of the outlet-side flange.
- Wrap the outlet-side flange and the duct connection area with aluminum tape or something similar to prevent air escaping.

### CAUTION

- Be sure to insulate the duct to prevent condensation from forming. (Material: glass wool or polyethylene foam, 1 in. thick)
- Use electric insulation between the duct and the wall when using metal ducts to pass metal laths of the net or fence shape or metal plating into wooden buildings.
- Be sure to explain about the way of maintaining and cleaning local procurements (air filter, grille (both air outlet and suction grille), etc.) to your customer.

## 9. ELECTRIC WIRING WORK

### 9-1 GENERAL INSTRUCTIONS

- Shut off the power before doing any work.
- All field supplied parts and materials, electric works must conform to local codes.
- Use copper wire only.
- See also the "Wiring Diagram label" attached to the control box lid when laying electrical wiring.
- For details on hooking up the remote controller, refer to the "REMOTE CONTROLLER INSTALLATION MANUAL"
- All wiring must be performed by an authorized electrician.
- This system consists of multiple indoor units. Mark each indoor unit as unit A, unit B . . . , and be sure the terminal board wiring to the outdoor unit and BS unit are properly matched. If wiring and piping between the outdoor unit and an indoor unit are mismatched, the system may cause a malfunction.

- Install a wiring interrupter or ground-fault circuit interrupter for the power wiring.
- Make sure the ground resistance is no greater than 100Ω.
- To avoid short circuiting the power supply wire, be sure to use insulated terminals.
- Do not turn on the power supply (wiring interrupter or ground-fault circuit interrupter) until all other work is done.

### DANGER

- Do not ground units to water pipes, telephone wires or lightning rods because incomplete grounding could cause a severe shock hazard resulting in severe injury or death, and to gas pipes because a gas leak could result in an explosion which could lead to severe injury or death.

### 9-2 LIST OF STANDARD WIRING EQUIPMENT

Power supply wiring (including ground wire)		Transmission wiring Remote controller wiring	
Field fuses	Size	Wire	Size
15A	Must comply with local codes.	Sheathed wire (2 wires)	AWG18 – 16

### NOTES

1. If the wiring is in a place where people it can be easily touched by people, install a ground-fault circuit interrupter to prevent electric shock.
  2. When using a ground-fault circuit interrupter, make sure to select one useful also to protection against overcurrent and short-circuit.  
When using a ground-fault circuit interrupter only for grounding device, make sure to use a wiring interrupter together.
- The length of the transmission wiring and remote controller wiring are as follows.

Length of the transmission wiring and remote controller wiring

Outdoor unit – Indoor unit	Max. 3280 ft. (Total wiring length: 6560 ft.)
Indoor unit – Remote controller	Max. 1640 ft.

### 9-3 ELECTRICAL CHARACTERISTICS

Units				Power supply		Fan motor	
Model	Hz	Volts	Voltage range	MCA	MFA	KW	FLA
07 · 09 · 12 type	60	208-230	Min. 187 Max. 253	0.9	15	0.062	0.7
18 type				1.3		0.13	1.0
24 type				1.4		0.13	1.1

MCA: Minimum Circuit Amps (A) MFA: Max. Fuse Amps (A)  
KW: Fan motor output (kW) FLA: Full Load Amps (A)

## 10. WIRING EXAMPLE

### 10-1 HOW TO CONNECT WIRINGS

- Wire only after removing the control box lid as shown in Fig. 14.

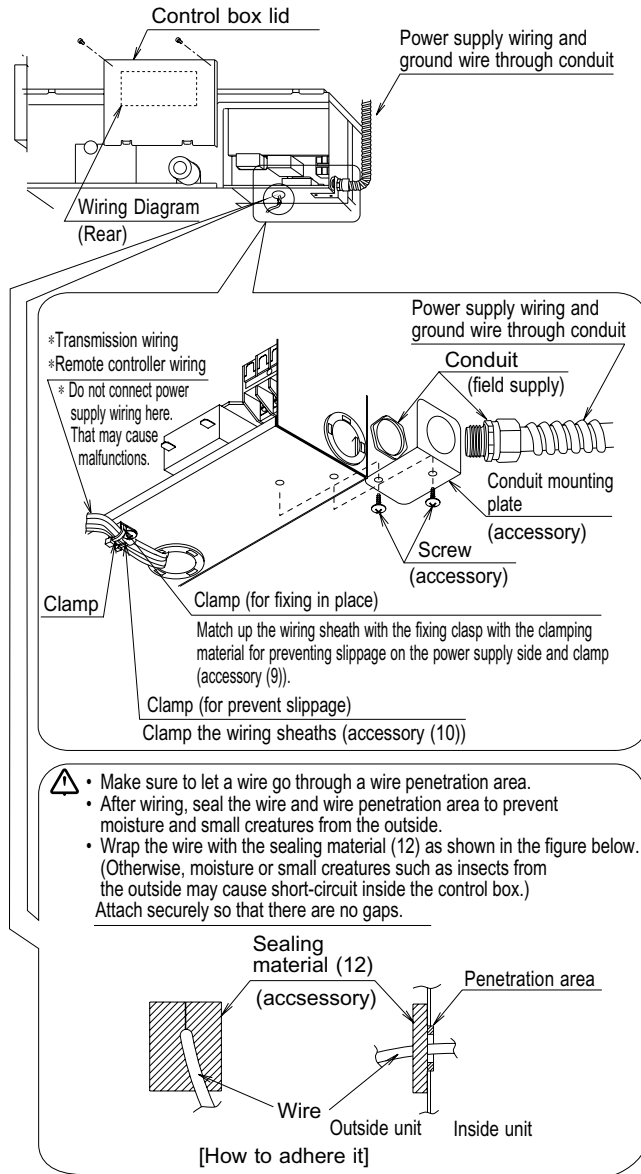

Fig. 14

### ⚠ DANGER

- Use only specified wire and connect wires to terminals tightly. Be careful that wires do not place external stress on terminals. Keep wires in neat order so as to not obstruct other equipment. Make sure that the electric parts box lid closes tightly. Incomplete connections could result in overheating, and in worse cases, electric shock or fire.

### ⚠ WARNING

- Never connect power supply wiring to the terminal block for remote controller wiring as this could damage the entire system.

### ⚠ CAUTION

- When clamping the wiring, use the included clamp material (9) and (10) as shown in the Fig.14 to prevent outside pressure being exerted on the wiring connections and clamp firmly.
- When doing the wiring, make sure the wiring is neat and does not cause the control box lid to stick up, then close the cover firmly. When attaching the control box lid, make sure you do not pinch any wires.
- Outside the air conditioners, separate the low voltage wiring (remote controller and transmission wiring) and high voltage wiring (ground wire and power supply wiring) at least 5 in. so that they do not pass through the same place together. Proximity may cause electrical interference, malfunctions, and breakage.

### [ PRECAUTIONS ]

- Refer to the "REMOTE CONTROLLER INSTALLATION MANUAL" on how to install and lay the wiring for the remote controller.
- See also the "Wiring Diagram label" attached to the control box lid when laying electrical wiring.
- Connect the remote controller and transmission wiring their respective terminal blocks.

### ⚠ CAUTION

- **Do not, under any circumstances, connect the power supply wiring to the remote controller or transmission wiring terminal block. Doing so can destroy the entire system.**

### [ Connecting electrical wiring, remote controller wiring, and transmission wiring ] (Refer to Fig. 15)

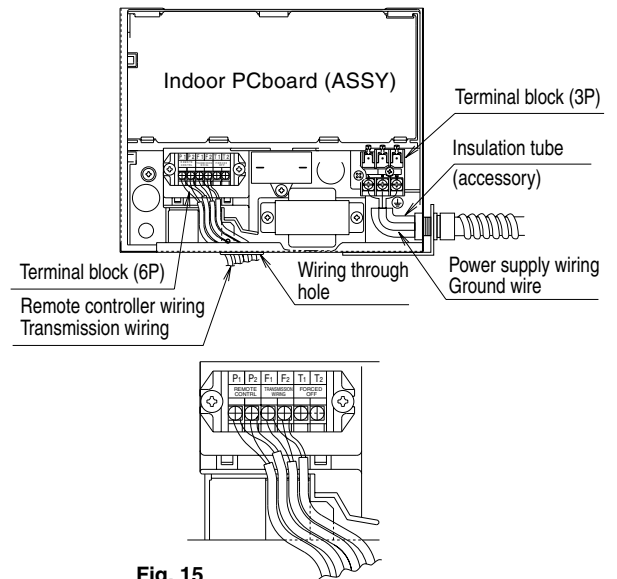

Fig. 15

- **Power supply wiring and Ground wire**  
Remove the control box lid.  
Next, pull the wires into the unit through the conduit and thread them through the insulation tube (accessory), then connect to the terminal block (3P).
- **Remote controller and transmission wiring**  
Pull the wires into the unit through the wiring through hole and connect to the terminal block (6P).  
Be sure to put the part of the sheathed vinyl into the control box.

[ WIRING EXAMPLE ]

**No. 1 system When using 1 remote controller for 1 indoor unit**

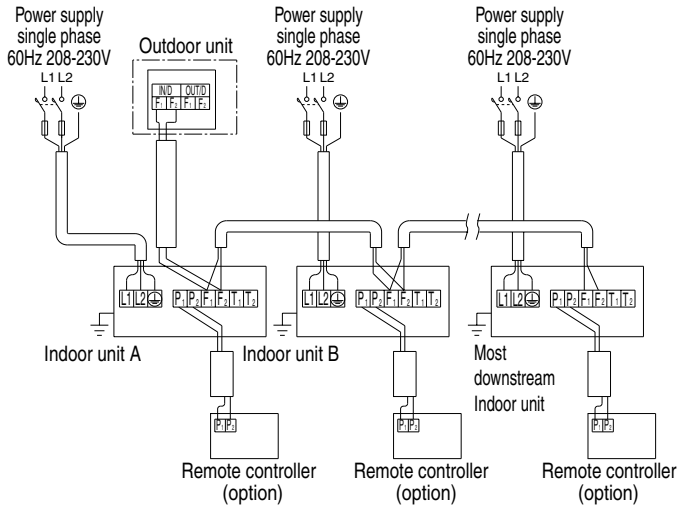

Fig. 16

**No. 2 system For group control or use with 2 remote controllers**

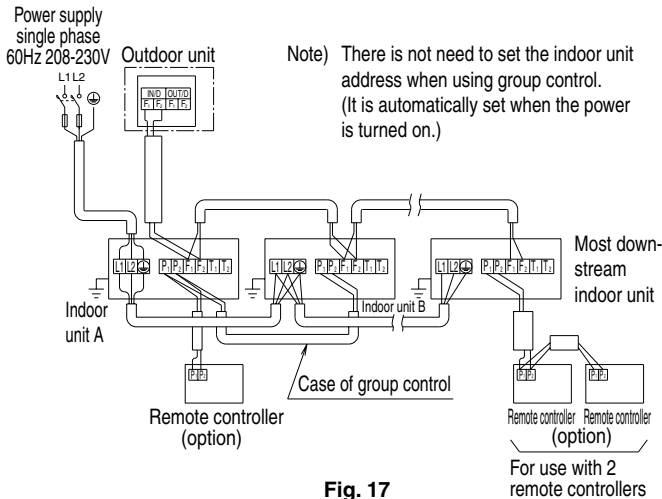

Fig. 17

**No. 3 system When including BS unit**

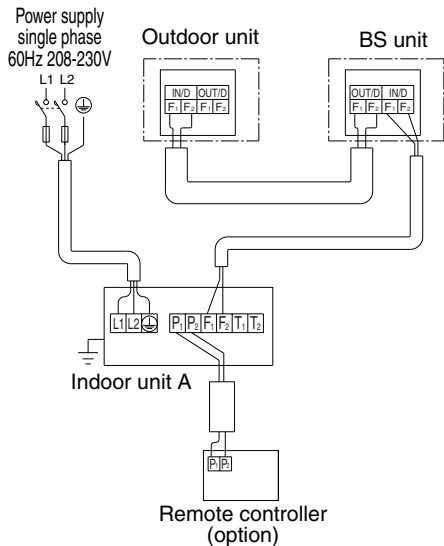
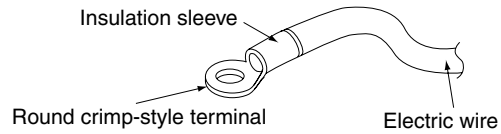

Fig. 18

< Precautions when laying power supply wiring >

- Wiring of different thicknesses cannot be connected to the power supply wiring terminal block. (Slack in the power supply wiring may cause abnormal heat.)
- Use sleeve-insulated round crimp-style terminals for connections to the power supply wiring terminal block. When none are available, connect wires of the same diameter to both sides, as shown in the figure.



Connect wires of the same gauge to both sides.

Do not connect wires of the same gauge to one side.

Do not connect wires of different gauges.

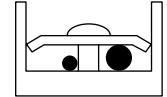
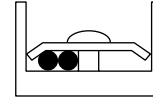
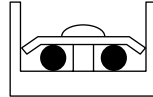

Follow the instructions are below if the wiring may get very hot due to slack in the power supply wiring.

- For wiring, use the designated power supply wiring and connect firmly, then secure to prevent outside pressure being exerted on the terminal board.
- Use the correct screwdriver for tightening the terminal screws. If the blade of screwdriver is too small, the head of the screw might be damaged, and the screw will not be properly tightened.
- If the terminal screws are tightened too hard, screws might be damaged.
- Refer to the table below for the tightening torque of the terminal screws.

Terminal block	Tightening torque (ft · lbf)
Remote controller / transmission wiring terminal block (6P)	0.58 – 0.72
Power supply wiring terminal block (3P)	0.87 – 1.06

**10-2 CONTROL BY 2 REMOTE CONTROLLERS (Controlling 1 indoor unit by 2 remote controllers)**

- When using 2 remote controllers, one must be set to "MAIN" and the other to "SUB".

**MAIN/SUB CHANGEOVER**

- (1) Insert a screwdriver into the recess between the upper and lower part of remote controller and, working from the 2 positions, pry off the upper part.

The remote controller PC board is attached to the upper part of remote controller.

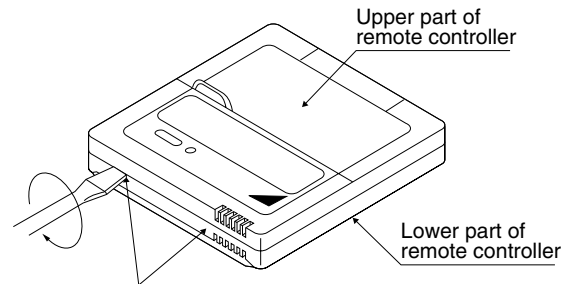

Insert the screwdriver here and gently work off the upper part of remote controller.

- (2) Turn the MAIN/SUB changeover switch on one of the two remote controller PC boards to “S”.  
(Leave the switch of the other remote controller set to “M”.)

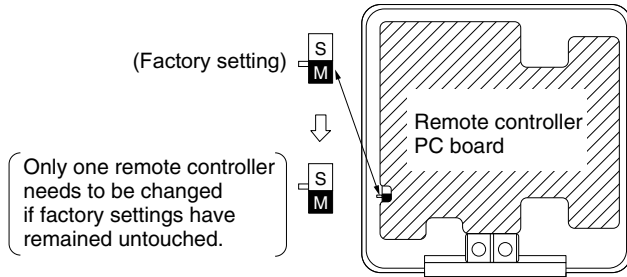

Wiring Method (See “9 ELECTRIC WIRING WORK”)

- (3) Remove the control box lid.  
(4) Add remote controller 2 (SUB) to the terminal block for remote controller (P<sub>1</sub>, P<sub>2</sub>) in the control box.  
(There is no polarity.)

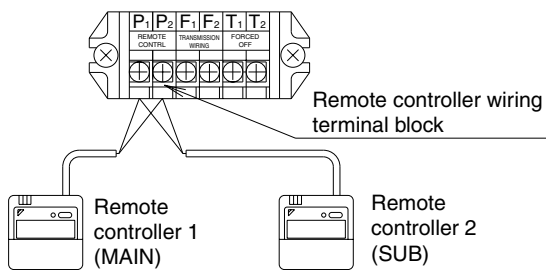

[ PRECAUTIONS ]

- Crossover wiring is needed when using group control and 2 remote controllers at the same time.
- Connect the indoor unit at the end of the crossover wire (P<sub>1</sub>, P<sub>2</sub>) to remote controller 2 (SUB).

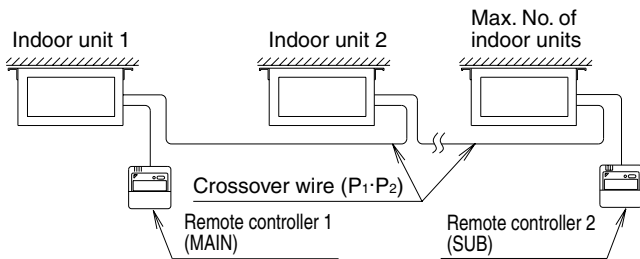

10-3 REMOTE CONTROL (FORCED OFF AND ON/OFF OPERATION)

- Connect input lines from the outside to the terminals T<sub>1</sub> and T<sub>2</sub> on the terminal block (6P) for remote controller to achieve remote control.
- See the “11. FIELD SETTING AND TEST RUN” for details on operation.

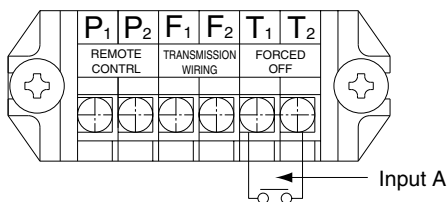

Wire specification	Sheathed vinyl cord or cable (2 wires)
Gauge	AWG18 – 16
Length	Max. 328 ft.
External terminal	Contact that can ensure the minimum applicable load of 15 V DC, 1 mA.

10-4 CENTRALIZED CONTROL

- For centralized control, it is necessary to designate the group No. For details, refer to the manual of each optional controllers for centralized control.

11. FIELD SETTING AND TEST RUN

Field settings may have to be performed using the remote controller, depending on the type of installation.

- (1) Make sure the control box lids are closed on the indoor and outdoor units.  
(2) Depending on the type of installation, make the field settings from the remote controller after the power is turned on, following the “Field Settings” manual which came with the remote controller.
- The settings can select “Mode No.,” “FIRST CODE NO.” and “SECOND CODE NO.”.
  - The “Field Settings” included with the remote controller lists the order of the settings and method of operation.

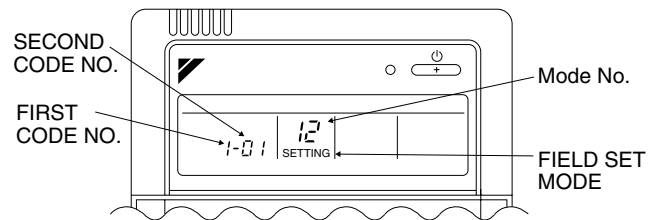

- Lastly, make sure the customer keeps the “Field Settings” manual, along with the operating manual, in a safe place.

11-1 SETTING THE STATIC PRESSURE SELECTION

- Select the SECOND CODE NO. for the resistance of the connected duct.  
(The SECOND CODE NO. is set to “01” when shipped.)
- See the technical documentation for details.

External static pressure	Mode No.	FIRST CODE NO.	SECOND CODE NO.
Standard	13(23)	5	01
High static pressure setting			02

11-2 REMOTE CONTROL SETTING

- Forced off and ON/OFF operation should be selected by selecting the SECOND CODE NO. as shown in the table below.  
(The SECOND CODE NO. is set to “01” when shipped.)

External ON/OFF input	Mode No.	FIRST CODE NO.	SECOND CODE NO.
Forced off	12(22)	1	01
ON/OFF operation			02

- Input A of forced off and ON/OFF operation work as shown in the table below.

Forced off	ON/OFF operation
Input A “on” to force a stop (remote controller reception prohibited)	Unit operated by changing input A from “off” to “on”
Input A “off” to allow remote controller	Unit stopped by changing input A from “on” to “off”

### 11-3 SETTING THE FILTER SIGN DISPLAY INTERVAL

- Explain the following to the customer if the filter dirt settings have been changed.
- The filter sign display time is set to 2500 hours (equivalent to 1 year's use) when shipped.
- The settings can be changed to not display.
- When installing the unit in a place with much dusts, set the filter sign display time to shorter intervals (1,250 hours).
- Explain it to the customer that the filter needs to be cleaned regularly to prevent clogging and also the time that is set.

Mode No.	FIRST CODE NO.		SECOND CODE NO.	
			01	02
10 (20)	0	Filter dirt	low	high
	1 (low/high)	Displayed time (units: hours)	2500/ 1250	10000/ 5000
	3	Filter sign display	ON	OFF

### 11-4 SETTINGS FOR SEPARATELY SOLD ACCESSORIES

- See the instruction manuals included with separately sold accessories for the necessary settings.

#### 〈 When using a wireless remote controller 〉

- A wireless remote controller address needs to be set when using a wireless remote controller. See the installation manual included with the wireless remote controller for details on how to make the settings.

#### (3) Perform a test run according to the outdoor unit's installation manual.

- The operation lamp of the remote controller will flash when a malfunction occurs. Check the malfunction code on the liquid crystal display to identify the point of trouble. An explanation of malfunction codes and the corresponding trouble is provided in "CAUTION FOR SERVICING" of the outdoor unit.

If the display shows any of the following, there is a possibility that the wiring was done incorrectly or that the power is not on, so check again.

Remote control display	Content
"  E1" display	<ul style="list-style-type: none"> <li>• There is a short circuit at the FORCED OFF terminals (T1, T2).</li> </ul>
"U3" display	<ul style="list-style-type: none"> <li>• The test-run has not been performed.</li> </ul>
"U4" display "UH" display	<ul style="list-style-type: none"> <li>• The power on the outdoor unit is off.</li> <li>• The outdoor unit has not been wired for power supply.</li> <li>• Wiring is incorrect for the transmission wiring and / or FORCED OFF wiring.</li> <li>• The transmission wiring is cut.</li> </ul>
"UF" display	<ul style="list-style-type: none"> <li>• Reversed transmission wiring</li> </ul>
No display	<ul style="list-style-type: none"> <li>• The power on the indoor unit is off.</li> <li>• The indoor unit has not been wired for power supply.</li> <li>• Wiring is incorrect for the remote controller wiring, the transmission wiring and / or the FORCED OFF wiring.</li> <li>• The remote controller wiring is cut.</li> </ul>

#### CAUTION

- Always stop the test run using the remote controller to stop operation.

- (4) After finishing the test run, make sure to check drainage in the drain pump according to "7. DRAIN PIPING WORK".

**DAIKIN INDUSTRIES, LTD.**

Head office:

Umeda Center Bldg., 2-4-12, Nakazaki-Nishi,  
Kita-ku, Osaka, 530-8323 Japan

Tokyo office:

JR Shinagawa East Bldg., 2-18-1, Konan,  
Minato-ku, Tokyo, 108-0075 Japan

