



SiUS372201EB

**R-410A**

# Service Manual



EMERION



**REYQ-AATJA/B, 208/230 V**  
**REYQ-AAAYDA/B, 460 V**

**Heat Recovery 60 Hz**

<b>Introduction .....</b>	<b>1</b>
1. Safety Cautions.....	2
1.1 Warnings and Cautions Regarding Safety of Workers.....	2
1.2 Warnings and Cautions Regarding Safety of Users.....	4
2. Icons Used .....	7
3. Revision History .....	8
<b>Part 1 General Information .....</b>	<b>9</b>
1. Model Names .....	10
1.1 Outdoor Unit.....	10
1.2 Branch Selector Unit .....	10
1.3 Indoor Unit.....	11
1.4 Air Treatment Equipment .....	11
2. External Appearance.....	12
2.1 Outdoor Unit.....	12
2.2 Branch Selector Unit .....	14
2.3 Indoor Unit.....	14
2.4 Air Treatment Equipment .....	16
3. Combination of Outdoor Units.....	17
4. Capacity Range.....	18
4.1 Connection Ratio.....	18
4.2 Outdoor Unit Combinations .....	19
4.3 Limitation of Capacity Index for Heat Recovery .....	20
5. Specifications .....	21
5.1 REYQ-AATJA, REYQ-AATJB .....	21
5.2 REYQ-AAYDA, REYQ-AAYDB .....	39
<b>Part 2 Refrigerant Circuit.....</b>	<b>57</b>
1. Refrigerant Circuit (Piping Diagrams) .....	58
1.1 Outdoor Unit.....	58
1.2 Branch Selector Unit .....	67
1.3 Indoor Unit.....	79
1.4 Outdoor-Air Processing Unit.....	82
2. Functional Parts Layout .....	83
2.1 REYQ72AA .....	83
2.2 REYQ96/120AA .....	85
2.3 REYQ144/168AA .....	88
2.4 REYQ192/216/240AA .....	91
3. Refrigerant Flow for Each Operation Mode.....	94
3.1 REYQ72AA .....	94
3.2 REYQ96/120/144/168AA .....	100
3.3 REYQ192/216/240AA .....	106

<b>Part 3 Remote Controller .....</b>	<b>112</b>
1. Applicable Models .....	113
2. Names and Functions .....	114
2.1 BRC1E73 .....	114
2.2 BRC1H71W.....	117
2.3 Wireless Remote Controller .....	125
3. Main/Sub Setting.....	126
3.1 BRC1E73 .....	126
3.2 BRC1H71W.....	128
3.3 When Wireless Remote Controller is Used Together.....	130
4. Address Setting for Wireless Remote Controller.....	131
5. Centralized Control Group No. Setting.....	133
5.1 BRC1E73 .....	133
5.2 BRC1H71W.....	135
5.3 Wireless Remote Controller .....	135
5.4 Group No. Setting Example.....	136
6. Service Settings Menu, Maintenance Menu.....	137
6.1 BRC1E73 .....	137
7. Administrator Menu, Installer Menu .....	141
7.1 BRC1H71W.....	141
 <b>Part 4 Functions and Control .....</b>	 <b>142</b>
1. Operation Flowchart.....	144
2. Stop Control .....	145
2.1 Stop due to Error .....	145
2.2 When System is in Stop Control.....	145
2.3 Sub Unit Stops during Master Unit Control .....	145
3. Standby Control .....	146
3.1 Restart Standby.....	146
3.2 Crankcase Heater Control.....	146
4. Startup Control .....	147
4.1 Startup Control in Cooling .....	148
4.2 Startup Control in Heating .....	148
5. Basic Control.....	149
5.1 Normal Control .....	149
5.2 Compressor PI Control.....	150
5.3 Compressor Step Control.....	151
5.4 Electronic Expansion Valve PI Control.....	155
5.5 Step Control of Outdoor Fans .....	156
5.6 Heat Exchanger Control .....	158
6. Protection Control .....	159
6.1 High Pressure Protection Control.....	159
6.2 Low Pressure Protection Control.....	161
6.3 Discharge Pipe Protection Control .....	162
6.4 Inverter Protection Control .....	163

7. Special Control.....	165
7.1 Pump Down Residual Operation .....	165
7.2 Oil Return Operation .....	166
7.3 Defrost Operation .....	169
7.4 Outdoor Unit Rotation.....	172
7.5 Cooling/Heating Mode Switching .....	173
8. Other Control.....	176
8.1 Backup Operation.....	176
8.2 Demand Operation .....	176
8.3 Heating Operation Prohibition .....	176
9. Outline of Control (Indoor Unit) .....	177
9.1 Operation Flowchart .....	177
9.2 Set Temperature and Control Target Temperature .....	181
9.3 Remote Controller Thermistor .....	183
9.4 Thermostat Control.....	185
9.5 Drain Pump Control.....	188
9.6 Control of Electronic Expansion Valve .....	190
9.7 Freeze-Up Prevention Control.....	191
9.8 List of Swing Flap Operations .....	193
9.9 Hot Start Control (In Heating Operation Only).....	194
9.10 Louver Control for Preventing Ceiling Dirt.....	195
9.11 Heater Control (Except FXTQ-TA, FXTQ-TB Models) .....	196
9.12 Heater Control (FXTQ-TA, FXTQ-TB Models) .....	197
9.13 Gas Furnace Control (CXTQ-TA Models) .....	200
9.14 3-Step Thermostat Processing (FXTQ-TA, FXTQ-TB Models) .....	201
9.15 Fan Control (Heater Residual) (FXTQ-TA, FXTQ-TB Models).....	202
9.16 Interlocked with External Equipment (FXTQ-TA, FXTQ-TB, CXTQ-TA Models).....	202

## **Part 5 Field Settings and Test Operation ..... 204**

1. Field Settings for Indoor Unit.....	205
1.1 Field Settings with Remote Controller .....	205
1.2 List of Field Settings for Indoor Unit .....	211
1.3 Applicable Field Settings .....	213
1.4 Details of Field Settings for Indoor Unit.....	217
1.5 Gas Furnace Set Up.....	236
1.6 List of Field Settings for Outdoor-Air Processing Unit .....	237
1.7 Operation Control Mode .....	237
2. Field Setting from Outdoor Unit.....	239
2.1 DIP Switch Setting when Mounting a Spare PCB .....	239
2.2 Accessing the BS Buttons on the PCB.....	241
2.3 Operating the BS Buttons and DIP Switches on the PCB .....	242
2.4 Connecting the PC Configurator to the Outdoor Unit .....	245
2.5 Monitoring Function and Field Settings .....	245
2.6 Cool/Heat Mode Changeover.....	270
2.7 Night-Time Low Noise Operation and Demand Operation .....	271
2.8 Energy Saving and Optimum Operation.....	276



3.	Field Settings for Branch Selector Unit .....	279
3.1	Field Settings for Single Branch Selector Unit .....	279
3.2	Field Settings for Multi Branch Selector Unit (Standard Series).....	280
3.3	Field Settings for Multi Branch Selector Unit (Flex Series) .....	281
3.4	How to Check Miswiring for Multi Branch Selector Unit .....	283
4.	Test Operation .....	284
4.1	Checks before Test Operation .....	284
4.2	Checkpoints.....	284
4.3	Gas Furnace Test Operation.....	285

## **Part 6 Service Diagnosis ..... 286**

1.	Symptom-based Troubleshooting .....	289
1.1	Indoor Unit Overall .....	289
1.2	With Gas Furnace .....	292
1.3	Gas Furnace Lockout Reset.....	292
1.4	With Infrared Presence/Floor Sensor .....	293
2.	Error Code via Remote Controller.....	294
2.1	BRC1E73 .....	294
2.2	BRC1H71W.....	295
2.3	Wireless Remote Controller .....	295
3.	Troubleshooting by Error Code .....	297
3.1	Error Codes and Descriptions .....	297
3.2	Error Codes (Sub Codes).....	299
3.3	Prediction Codes .....	309
3.4	External Protection Device Abnormality .....	313
3.5	Indoor Unit Control PCB Abnormality.....	315
3.6	Drain Level Control System Abnormality.....	316
3.7	Indoor Fan Motor Lock, Overload.....	318
3.8	Indoor Fan Motor Abnormality.....	320
3.9	Overload/Overcurrent/Lock of Indoor Fan Motor.....	326
3.10	Blower Motor Not Running .....	327
3.11	Indoor Fan Motor Status Abnormality.....	328
3.12	Low Indoor Airflow.....	329
3.13	Swing Flap Motor Abnormality .....	330
3.14	Power Supply Voltage Abnormality .....	332
3.15	Blower Motor Stops for Over/Under Voltage .....	333
3.16	Electronic Expansion Valve Coil Abnormality, Dust Clogging .....	334
3.17	Gas Furnace Abnormality.....	335
3.18	Drain Level above Limit.....	336
3.19	Self-Cleaning Decoration Panel Abnormality .....	337
3.20	Defective Capacity Setting .....	348
3.21	Transmission Abnormality between Indoor Unit Control PCB and Fan PCB .....	349
3.22	Blower Motor Communication Error .....	351
3.23	Climate Talk Communication Error .....	352
3.24	Thermistor Abnormality .....	353
3.25	Combination Error between Indoor Unit Control PCB and Fan PCB .....	354
3.26	Capacity Setting Abnormality .....	355

3.27 Blower Motor HP Mismatch.....	356
3.28 Indoor Blower Does Not Have Required Parameters to Function.....	357
3.29 Remote Sensor Abnormality .....	358
3.30 Humidity Sensor System Abnormality.....	359
3.31 Infrared Presence/Floor Sensor Error .....	360
3.32 Remote Controller Thermistor Abnormality .....	365
3.33 Outdoor Unit Main/Sub PCB Abnormality .....	366
3.34 Detection of Ground Leakage by Leak Detection Circuit .....	367
3.35 Missing of Ground Leakage Detection Core .....	368
3.36 Activation of High Pressure Switch .....	369
3.37 Activation of Low Pressure Sensor .....	371
3.38 Compressor Motor Lock .....	372
3.39 Compressor Damage Alarm.....	374
3.40 Outdoor Fan Motor Abnormality .....	376
3.41 Electronic Expansion Valve Coil Abnormality or Sub PCB Momentary Overcurrent .....	378
3.42 Four Way Valve Abnormality (Intermediate Stop) .....	379
3.43 Four Way Valve Abnormality (Not Switching) .....	380
3.44 Opposite Air Conditioning Alarm .....	382
3.45 Discharge Pipe Temperature Abnormality .....	383
3.46 Wet Alarm.....	385
3.47 Refrigerant Overcharged.....	387
3.48 Branch Selector Unit Electronic Expansion Valve Abnormality.....	388
3.49 Thermistor Abnormality .....	390
3.50 Harness Abnormality (between Outdoor Unit Main PCB and Inverter PCB).....	391
3.51 Outdoor Fan PCB Abnormality .....	392
3.52 High Pressure Sensor Abnormality .....	393
3.53 Low Pressure Sensor Abnormality .....	394
3.54 Inverter PCB Abnormality.....	395
3.55 Momentary Power Failure during Test Operation .....	397
3.56 Inverter Radiation Fin Temperature Rise Abnormality .....	398
3.57 Compressor Instantaneous Overcurrent .....	401
3.58 Compressor Overcurrent.....	403
3.59 Compressor Startup Abnormality .....	405
3.60 Transmission Error between Inverter PCB and Outdoor Unit Main PCB...	407
3.61 Power Supply Voltage Imbalance .....	409
3.62 Inverter Radiation Fin Temperature Abnormality .....	411
3.63 Field Setting Abnormality after Replacing Outdoor Unit Main PCB or Combination of PCB Abnormality .....	413
3.64 Refrigerant Shortage .....	414
3.65 Reverse Phase, Open Phase, Power Supply Frequency Issue .....	415
3.66 Power Supply Insufficient or Instantaneous Abnormality .....	416
3.67 Check Operation Not Executed.....	418
3.68 Transmission Error between Indoor Units and Outdoor Units, Open Phase in Power Supply Wiring .....	419
3.69 Transmission Error between Remote Controller and Indoor Unit.....	422
3.70 Transmission Error between Outdoor Units .....	423
3.71 Transmission Error between Main and Sub Remote Controllers .....	429

3.72	Transmission Error between Indoor Units and Outdoor Units in the Same System .....	430
3.73	Improper Combination of Indoor, Branch Selector and Outdoor Units .....	431
3.74	Incorrect Gas Furnace Connecting Number .....	438
3.75	Incorrect Electric Heater Capacity Setting .....	439
3.76	Address Duplication of Centralized Controller .....	440
3.77	Transmission Error between Centralized Controller and Indoor Unit .....	441
3.78	System Not Set Yet .....	444
3.79	System Abnormality, Refrigerant System Address Undefined .....	445
3.80	Climate Talk Communication System Combination Error (Before Initial Setting for Communication Completes) .....	447
3.81	Climate Talk Communication System Combination Error (After Initial Setting for Communication Completes) .....	448
4.	Check .....	449
4.1	High Pressure Check .....	449
4.2	Low Pressure Check .....	450
4.3	Superheat Operation Check .....	452
4.4	Power Transistor Check .....	454
4.5	Refrigerant Overcharge Check .....	456
4.6	Refrigerant Shortage Check .....	457
4.7	Vacuumping and Dehydration Procedure .....	458
4.8	Thermistor Check .....	459
4.9	Pressure Sensor Check .....	463
4.10	Broken Wire Check of the Relay Wires .....	464
4.11	Fan Motor Connector Check (Power Supply Cable) .....	466
4.12	Fan Motor Connector Check (Signal Cable) .....	468
4.13	Electronic Expansion Valve Coil Check .....	470
4.14	Fan Motor Connector Check for FXTQ-TA, FXTQ-TB .....	474

## **Part 7 Appendix .....** **478**

1.	Wiring Diagrams .....	479
1.1	Outdoor Unit .....	479
1.2	Branch Selector Unit .....	481
1.3	Indoor Unit .....	490
1.4	Air Treatment Equipment .....	512
2.	Electrical Component Box Removal .....	515

# Introduction

1. Safety Cautions.....	2
1.1 Warnings and Cautions Regarding Safety of Workers.....	2
1.2 Warnings and Cautions Regarding Safety of Users.....	4
2. Icons Used .....	7
3. Revision History .....	8

# 1. Safety Cautions

Be sure to read the following safety cautions before conducting repair work.

After the repair work is complete, be sure to conduct a test operation to ensure that the equipment operates normally, and explain the cautions for operating the product to the customer.

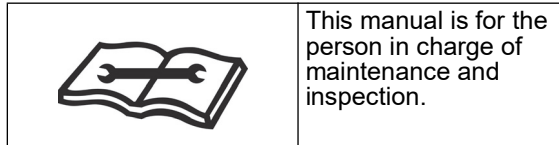







## Caution Items







The caution items are classified into **Warning** and **Caution**. The **Warning** items are especially important since death or serious injury can result if they are not followed closely. The **Caution** items can also lead to serious accidents under some conditions if they are not followed. Therefore, be sure to observe all the safety caution items described below.







## Pictograms



- △ This symbol indicates an item for which caution must be exercised. The pictogram shows the item to which attention must be paid.
- This symbol indicates a prohibited action. The prohibited item or action is shown in the illustration or near the symbol.
- This symbol indicates an action that must be taken, or an instruction. The instruction is shown in the illustration or near the symbol.

## 1.1 Warnings and Cautions Regarding Safety of Workers









 <b>Warning</b>	
<p><b>Do not store equipment in a room with fire sources (e.g., naked flames, gas appliances, electric heaters).</b></p>	
<p><b>Be sure to disconnect the power cable from the socket before disassembling equipment for repair.</b> Working on equipment that is connected to the power supply may cause an electrical shock. If it is necessary to supply power to the equipment to conduct the repair or inspect the circuits, do not touch any electrically charged sections of the equipment.</p>	
<p><b>If refrigerant gas is discharged during repair work, do not touch the discharged refrigerant gas.</b> Refrigerant gas may cause frostbite.</p>	
<p><b>When disconnecting the suction or discharge pipe of the compressor at the welded section, evacuate the refrigerant gas completely at a well-ventilated place first.</b> If there is gas remaining inside the compressor, the refrigerant gas or refrigerating machine oil discharges when the pipe is disconnected, and it may cause injury.</p>	
<p><b>If refrigerant gas leaks during repair work, ventilate the area.</b> Refrigerant gas may generate toxic gases when it contacts flames.</p>	







 <b>Warning</b>	
<p><b>Be sure to discharge the capacitor completely before conducting repair work.</b> The step-up capacitor supplies high-voltage electricity to the electrical components of the outdoor unit. A charged capacitor may cause an electrical shock.</p>	
<p><b>Do not turn the air conditioner on or off by plugging in or unplugging the power cable.</b> Plugging in or unplugging the power cable to operate the equipment may cause an electrical shock or fire.</p>	
<p><b>Be sure to wear a safety helmet, gloves, and a safety belt when working in a high place (more than 2 m (6.5 ft)).</b> Insufficient safety measures may cause a fall.</p>	
<p><b>In case of R-410A refrigerant models, be sure to use pipes, flare nuts and tools intended for the exclusive use with the R-410A refrigerant.</b> The use of materials for other refrigerant models may cause a serious accident, such as damage to the refrigerant cycle or equipment failure.</p>	
<p><b>Do not mix air or gas other than the specified refrigerant (R-410A) in the refrigerant system.</b> If air enters the refrigerant system, an excessively high pressure results, causing equipment damage and injury.</p>	







 <b>Caution</b>	
<p><b>Do not repair electrical components with wet hands.</b> Working on the equipment with wet hands may cause an electrical shock.</p>	
<p><b>Do not clean the air conditioner with water.</b> Washing the unit with water may cause an electrical shock.</p>	
<p><b>Be sure to provide an earth / grounding when repairing the equipment in a humid or wet place, to avoid electrical shocks.</b></p>	
<p><b>Be sure to turn off the power switch and unplug the power cable when cleaning the equipment.</b> The internal fan rotates at a high speed, and may cause injury.</p>	
<p><b>Be sure to conduct repair work with appropriate tools.</b> The use of inappropriate tools may cause injury.</p>	

 <b>Caution</b>	
<b>Be sure to check that the refrigerating cycle section has cooled down enough before conducting repair work.</b> Working on the unit when the refrigerating cycle section is hot may cause burns.	
<b>Conduct welding work in a well-ventilated place.</b> Using the welder in an enclosed room may cause oxygen deficiency.	





## 1.2 Warnings and Cautions Regarding Safety of Users

 <b>Warning</b>	
<b>Do not store the equipment in a room with fire sources (e.g., naked flames, gas appliances, electric heaters).</b>	
<b>Be sure to use parts listed in the service parts list of the applicable model and appropriate tools to conduct repair work. Never attempt to modify the equipment.</b> The use of inappropriate parts or tools may cause an electrical shock, excessive heat generation or fire.	
<b>If the power cable and lead wires are scratched or have deteriorated, be sure to replace them.</b> Damaged cable and wires may cause an electrical shock, excessive heat generation or fire.	
<b>Do not use a joined power cable or extension cable, or share the same power outlet with other electrical appliances, since it may cause an electrical shock, excessive heat generation or fire.</b>	
<b>Be sure to use an exclusive power circuit for the equipment, and follow the local technical standards related to the electrical equipment, the internal wiring regulations, and the instruction manual for installation when conducting electrical work.</b> Insufficient power circuit capacity and improper electrical work may cause an electrical shock or fire.	
<b>Be sure to use the specified cable for wiring between the indoor and outdoor units.</b> Make the connections securely and route the cable properly so that there is no force pulling the cable at the connection terminals. Improper connections may cause excessive heat generation or fire.	
<b>When wiring between the indoor and outdoor units, make sure that the terminal cover does not lift off or dismount because of the cable.</b> If the cover is not mounted properly, the terminal connection section may cause an electrical shock, excessive heat generation or fire.	
<b>Do not damage or modify the power cable.</b> Damaged or modified power cables may cause an electrical shock or fire. Placing heavy items on the power cable, or heating or pulling the power cable may damage it.	

 <b>Warning</b>	
<p><b>Do not mix air or gas other than the specified refrigerant (R-410A) in the refrigerant system.</b> If air enters the refrigerant system, an excessively high pressure results, causing equipment damage and injury.</p>	
<p><b>If the refrigerant gas leaks, be sure to locate the leaking point and repair it before charging the refrigerant. After charging the refrigerant, make sure that there is no leak.</b> If the leaking point cannot be located and the repair work must be stopped, be sure to pump-down, and close the service valve, to prevent refrigerant gas from leaking into the room. Refrigerant gas itself is harmless, but it may generate toxic gases when it contacts flames, such as those from fan type and other heaters, stoves and ranges.</p>	
<p><b>When relocating the equipment, make sure that the new installation site has sufficient strength to withstand the weight of the equipment.</b> If the installation site does not have sufficient strength or the installation work is not conducted securely, the equipment may fall and cause injury.</p>	
<p><b>Check to make sure that the power cable plug is not dirty or loose, then insert the plug into a power outlet securely.</b> If the plug is dusty or has a loose connection, it may cause an electrical shock or fire.</p>	
<p><b>When replacing the coin battery in the remote controller, be sure to dispose of the old battery to prevent children from swallowing it.</b> If a child swallows the coin battery, see a doctor immediately.</p>	





 <b>Caution</b>	
<p><b>Installation of a leakage breaker is necessary in some cases depending on the conditions of the installation site, to prevent electrical shocks.</b></p>	
<p><b>Do not install the equipment in a place where there is a possibility of combustible gas leaks.</b> If combustible gas leaks and remains around the unit, it may cause a fire.</p>	
<p><b>Check to see if parts and wires are mounted and connected properly, and if connections at the soldered or crimped terminals are secure.</b> Improper installation and connections may cause excessive heat generation, fire or an electrical shock.</p>	
<p><b>If the installation platform or frame has corroded, replace it.</b> A corroded installation platform or frame may cause the unit to fall, resulting in injury.</p>	
<p><b>Check the earth / grounding, and repair it if the equipment is not properly earthed / grounded.</b> Improper earth / grounding may cause an electrical shock.</p>	



 <b>Caution</b>	
<b>Be sure to measure insulation resistance after the repair, and make sure that the resistance is 1 MΩ or greater.</b> Faulty insulation may cause an electrical shock.	
<b>Be sure to check the drainage of the indoor unit after the repair.</b> Faulty drainage may cause water to enter the room and wet the furniture and floor.	
<b>Do not tilt the unit when removing it.</b> The water inside the unit may spill and wet the furniture and floor.	

## 2. Icons Used

The following icons are used to attract the attention of the reader to specific information.

Icon	Type of Information	Description
 Warning	Warning	<b>Warning</b> is used when there is danger of personal injury.
 Caution	Caution	<b>Caution</b> is used when there is danger that the reader, through incorrect manipulation, may damage equipment, lose data, get an unexpected result or have to restart (part of) a procedure.
 Note	Note	<b>Note</b> provides information that is not indispensable, but may nevertheless be valuable to the reader, such as tips and tricks.
 Reference	Reference	<b>Reference</b> guides the reader to other places in this binder or in this manual, where he/she will find additional information on a specific topic.

### 3. Revision History

Month / Year	Version	Revised contents
03 / 2022	SiUS372201E	First edition
12 / 2022	SiUS372201EA	Addition of error codes and prediction codes Model addition: FXSQ05-54TBVJU, FXMQ15-54TBVJU
11 / 2023	SiUS372201EB	Model addition: REYQ72-480AATJB, REYQ72-480AAYDB, FXFQ07-54AAVJU, FXMQ72/96TAVJU, FXTQ09-60TBVJUA, FXTQ09-60TBVJUD

---

# Part 1

## General Information

1. Model Names .....	10
1.1 Outdoor Unit .....	10
1.2 Branch Selector Unit .....	10
1.3 Indoor Unit.....	11
1.4 Air Treatment Equipment .....	11
2. External Appearance.....	12
2.1 Outdoor Unit.....	12
2.2 Branch Selector Unit .....	14
2.3 Indoor Unit.....	14
2.4 Air Treatment Equipment .....	16
3. Combination of Outdoor Units .....	17
4. Capacity Range.....	18
4.1 Connection Ratio.....	18
4.2 Outdoor Unit Combinations .....	19
4.3 Limitation of Capacity Index for Heat Recovery .....	20
5. Specifications .....	21
5.1 REYQ-AATJA, REYQ-AATJB .....	21
5.2 REYQ-AAYDA, REYQ-AAYDB .....	39

# 1. Model Names

## 1.1 Outdoor Unit

### REYQ-AATJA, REYQ-AATJB (208/230 V)

Capacity range (ton)		6	8	10	12	14	16	18	20	22	Power supply, Standard
Capacity index		72	96	120	144	168	192	216	240	264	
Heat recovery	REYQ	72AA	96AA	120AA	144AA	168AA	192AA	216AA	240AA	264AA	TJA TJB

Capacity range (ton)		24	26	28	30	32	34	36	38	40	Power supply, Standard
Capacity index		288	312	336	360	384	408	432	456	480	
Heat recovery	REYQ	288AA	312AA	336AA	360AA	384AA	408AA	432AA	456AA	480AA	TJA TJB

TJ: 3 phase, 208/230 V, 60 Hz  
A, B: Minor revision

### REYQ-AAYDA, REYQ-AAYDB (460 V)

Capacity range (ton)		6	8	10	12	14	16	18	20	22	Power supply, Standard
Capacity index		72	96	120	144	168	192	216	240	264	
Heat recovery	REYQ	72AA	96AA	120AA	144AA	168AA	192AA	216AA	240AA	264AA	YDA YDB

Capacity range (ton)		24	26	28	30	32	34	36	38	40	Power supply, Standard
Capacity index		288	312	336	360	384	408	432	456	480	
Heat recovery	REYQ	288AA	312AA	336AA	360AA	384AA	408AA	432AA	456AA	480AA	YDA YDB

YD: 3 phase, 460 V, 60 Hz  
A, B: Minor revision

## 1.2 Branch Selector Unit

### Single Branch Selector Unit

Series		Model name			Power supply, Standard
BSQ		36T	60T	96T	
		36TA	60TA	96TA	VJ

**Note:** No interchangeability with BSVQ36/60/96PVJU.  
VJ: 1 phase, 208/230 V, 60 Hz

### Multi Branch Selector Unit

Series		Model name					Power supply, Standard
Standard series	BS	4Q54T	6Q54T	8Q54T	10Q54T	12Q54T	
		4Q54TA	—	—	10Q54TA	12Q54TA	VJ
Flex series	BSF	4Q54T	6Q54T	8Q54T	—	—	

**Note:** No interchangeability with BSV4/6Q36PVJU.  
VJ: 1 phase, 208/230 V, 60 Hz

### 1.3 Indoor Unit

Capacity range (ton)		0.5	0.6	0.8	1	1.25	1.5		2	2.5	3	3.5	4	4.5	5	6	8	Power supply, Standard	
Capacity index		5.8	7.5	9.5	12	15	18	20	24	30	36	42	48	54	60	72	96		
Ceiling mounted cassette (Round flow with sensing) type	FXFQ	—	07AA	09AA	12AA	15AA	18AA	—	24AA	30AA	36AA	—	48AA	54AA	—	—	—	VJU*	
		—	07T	09T	12T	15T	18T	—	24T	30T	36T	—	48T	—	—	—	—		
VISTA™ 2'x2' cassette type	FXZQ	05TA	07TA	09TA	12TA	15TA	18TA	—	—	—	—	—	—	—	—	—	—		
		05TB	07TB	09TB	12TB	15TB	18TB	—	—	—	—	—	—	—	—	—	—		
4-way blow ceiling suspended type	FXUQ	—	—	—	—	—	—	—	18P	24P	30P	36P	—	—	—	—	—		
		—	—	—	—	—	—	—	18PA	24PA	30PA	36PA	—	—	—	—	—		
One way blow cassette type	FXEQ	—	07P	09P	12P	15P	18P	—	24P	—	—	—	—	—	—	—	—		
Slim ceiling mounted duct type	FXDQ	—	07M	09M	12M	—	18M	—	24M	—	—	—	—	—	—	—	—		
MSP concealed ducted type	FXSQ	05TA	07TA	09TA	12TA	15TA	18TA	—	24TA	30TA	36TA	—	48TA	54TA	—	—	—		
		05TB	07TB	09TB	12TB	15TB	18TB	—	24TB	30TB	36TB	—	48TB	54TB	—	—	—		
Ceiling mounted duct type (Middle and high static pressure)	FXMQ	—	07PB	09PB	12PB	15PB	18PB	—	24PB	30PB	36PB	—	48PB	54PB	—	—	—		
Ceiling mounted duct type (High static pressure)	FXMQ	—	—	—	—	15TB	18TB	—	24TB	30TB	36TB	—	48TB	54TB	—	—	—		
Ceiling mounted duct type	FXMQ	—	—	—	—	—	—	—	—	—	—	—	—	—	—	72TA	96TA		
		—	—	—	—	—	—	—	—	—	—	—	—	—	—	72M	96M		
Ceiling suspended type	FXHQ	—	—	—	12M	—	—	—	24M	—	36M	—	—	—	—	—	—		
Wall mounted type	FXAQ	—	07P	09P	12P	—	18P	—	24P	—	—	—	—	—	—	—	—		
Floor standing type	FXLQ	—	07M	09M	12M	—	18M	—	24M	—	—	—	—	—	—	—	—		
Concealed floor standing type	FXNQ	—	07M	09M	12M	—	18M	—	24M	—	—	—	—	—	—	—	—		
Air handling unit	FXTQ	—	—	09TA	12TA	—	18TA	—	24TA	30TA	36TA	42TA	48TA	54TA	60TA	—	—		VJUA*
		—	—	09TB	12TB	—	18TB	—	24TB	30TB	36TB	42TB	48TB	54TB	60TB	—	—		
		—	—	09TA	12TA	—	18TA	—	24TA	30TA	36TA	42TA	48TA	54TA	60TA	—	—	VJUD*	
		—	—	09TB	12TB	—	18TB	—	24TB	30TB	36TB	42TB	48TB	54TB	60TB	—	—		
Cased Coil Unit	CXTQ	—	—	—	—	—	—	—	24TA	—	36TA	—	48TA	—	60TA	—	—	SBLU*	

VJ: 1 phase, 208/230 V, 60 Hz

SBL: 1 phase, 115 V, 60 Hz

U: Standard symbol

### 1.4 Air Treatment Equipment

#### Outdoor-Air Processing Unit

Series	Model name			Power supply, Standard
FXMQ	48MF	72MF	96MF	VJU*

#### Energy Recovery Ventilator (VAM series)

Series	Model name				Power supply, Standard
VAM	300G	470G	600G	1200G	VJU*

VJ: 1 phase, 208/230 V, 60 Hz

U: Standard symbol

## 2. External Appearance

### 2.1 Outdoor Unit

#### Single Outdoor Unit

#### 6 ton

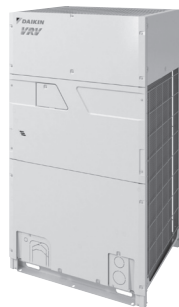

REYQ72AATJA

REYQ72AATJB

REYQ72AAYDA

REYQ72AAYDB

#### 8, 10, 12, 14 ton

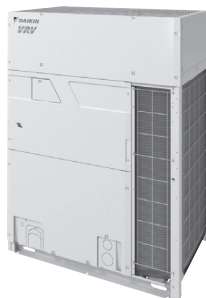

REYQ96AATJA  
REYQ120AATJA  
REYQ144AATJA  
REYQ168AATJA

REYQ96AATJB  
REYQ120AATJB  
REYQ144AATJB  
REYQ168AATJB

REYQ96AAYDA  
REYQ120AAYDA  
REYQ144AAYDA  
REYQ168AAYDA

REYQ96AAYDB  
REYQ120AAYDB  
REYQ144AAYDB  
REYQ168AAYDB

#### 16, 18, 20 ton



REYQ192AATJA  
REYQ216AATJA  
REYQ240AATJA

REYQ192AATJB  
REYQ216AATJB  
REYQ240AATJB

REYQ192AAYDA  
REYQ216AAYDA  
REYQ240AAYDA

REYQ192AAYDB  
REYQ216AAYDB  
REYQ240AAYDB

Double Outdoor Unit

22, 24, 26, 28 ton

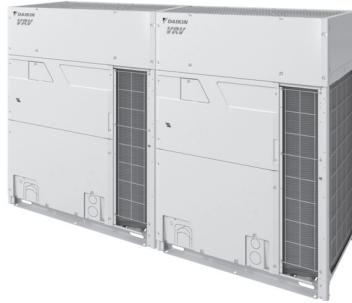

REYQ264AATJA  
REYQ288AATJA  
REYQ312AATJA  
REYQ336AATJA

REYQ264AATJB  
REYQ288AATJB  
REYQ312AATJB  
REYQ336AATJB

REYQ264AAYDA  
REYQ288AAYDA  
REYQ312AAYDA  
REYQ336AAYDA

REYQ264AAYDB  
REYQ288AAYDB  
REYQ312AAYDB  
REYQ336AAYDB

30 ton

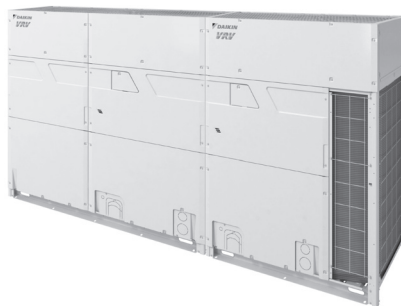

REYQ360AATJA

REYQ360AATJB

REYQ360AAYDA

REYQ360AAYDB

32, 34, 36, 38, 40 ton

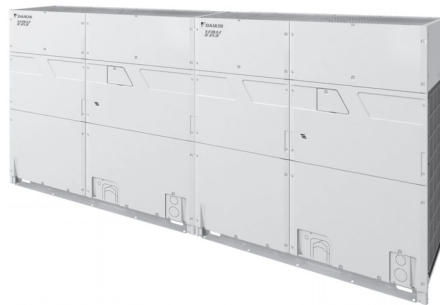

REYQ384AATJA  
REYQ408AATJA  
REYQ432AATJA  
REYQ456AATJA  
REYQ480AATJA

REYQ384AATJB  
REYQ408AATJB  
REYQ432AATJB  
REYQ456AATJB  
REYQ480AATJB

REYQ384AAYDA  
REYQ408AAYDA  
REYQ432AAYDA  
REYQ456AAYDA  
REYQ480AAYDA

REYQ384AAYDB  
REYQ408AAYDB  
REYQ432AAYDB  
REYQ456AAYDB  
REYQ480AAYDB



## 2.2 Branch Selector Unit

### Single Branch Selector Unit

BSQ-T  
BSQ-TA

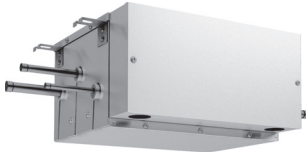

### Multi Branch Selector Unit (Standard Series)

BS-Q54T  
BS-Q54TA



### Multi Branch Selector Unit (Flex Series)

BSF-Q54T

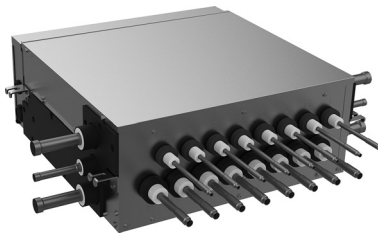

## 2.3 Indoor Unit

Ceiling mounted cassette (Round flow with sensing) type  
FXFQ-AA



Shown with BYCQ54EEFU

VISTA™ 2'x2' cassette type  
FXZQ-TA  
FXZQ-TB

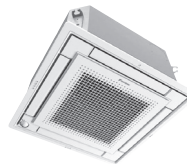

Shown with BYFQ60C3W1W/  
BYFQ60C3W2W



Shown with BYFQ60C3W1S

Ceiling mounted cassette (Round flow with sensing) type  
FXFQ-T



Shown with BYCQ125B-W1

4-way blow ceiling suspended type  
FXUQ-P  
FXUQ-PA



<p>One way blow cassette type FXEQ-P</p> 	<p>Ceiling suspended type FXHQ-M</p> 
<p>Slim ceiling mounted duct type FXDQ-M</p> 	<p>Wall mounted type FXAQ-P</p> 
<p>MSP concealed ducted type FXSQ-TA FXSQ-TB</p> 	<p>Floor standing type FXLQ-M</p> 
<p>Ceiling mounted duct type (Middle and high static pressure) FXMQ-PB</p> 	<p>Concealed floor standing type FXNQ-M</p> 
<p>Ceiling mounted duct type (High static pressure) FXMQ-TB</p> 	<p>Air handling unit FXTQ-TA FXTQ-TB</p> 
<p>Ceiling mounted duct type FXMQ-TA</p> 	<p>Cased coil unit CXTQ-TA</p> 
<p>Ceiling mounted duct type FXMQ-M</p> 	

## 2.4 Air Treatment Equipment

Outdoor-air processing unit  
FXMQ-MF

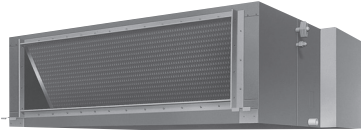

Energy recovery ventilator (VAM series)  
VAM-G

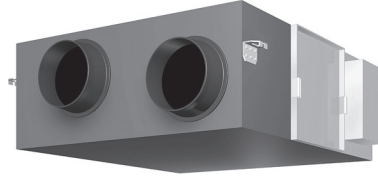

### 3. Combination of Outdoor Units

Model name	System capacity		Number of units	Module							
	Ton	HP		72	96	120	144	168	192	216	240
REYQ72AA	6	7.5	1	●							
REYQ96AA	8	10.0	1		●						
REYQ120AA	10	12.5	1			●					
REYQ144AA	12	15.0	1				●				
REYQ168AA	14	17.5	1					●			
REYQ192AA	16	20.0	1						●		
REYQ216AA	18	22.5	1							●	
REYQ240AA	20	25.0	1								●
REYQ264AA	22	27.5	2			●	●				
REYQ288AA	24	30.0	2				●●				
REYQ312AA	26	32.5	2				●	●			
REYQ336AA	28	35.0	2					●●			
REYQ360AA	30	37.5	2					●	●		
REYQ384AA	32	40.0	2						●●		
REYQ408AA	34	42.5	2						●	●	
REYQ432AA	36	45.0	2							●●	
REYQ456AA	38	47.5	2							●	●
REYQ480AA	40	50.0	2								●●

- Notes:** For multiple connection, the following kits are required;
- Outdoor unit multi connection piping kit: BHFP26P100U / BHFP26P100UA
  - Reducer piping kit: KHFP26P100UA

# 4. Capacity Range

## 4.1 Connection Ratio

$$\text{Connection ratio} = \frac{\text{Total capacity index of the indoor units}}{\text{Capacity index of the outdoor units}}$$

Type		Min. connection ratio	Max. connection ratio				
			Types of connected indoor units			Type of connected air treatment equipment	
			When using only FXFQ12-54AA, FXDQ-M, FXSQ07TA, FXSQ07TB, FXMQ-PB, FXAQ-P	When using at least one FXFQ07/09AA, FXFQ07/09T, FXZQ05TA, FXZQ05TB, FXSQ05TA, FXSQ05TB	Other indoor unit models	FXMQ-MF	
When FXMQ-MF is only connected	When FXMQ-MF and indoor units are connected						
Single outdoor units	6-14 ton	50%	200% *1	180% *1	200% *1	100%	100% *2
	16-20 ton			180% *1	180% *1		
Double outdoor units							

- Notes:**
- \*1. If the operational capacity of indoor units is more than 130%, low airflow operation is enforced in all the indoor units. This limitation can be deactivated through field setting. Refer to page 261 for detail.
  - \*2. When outdoor-air processing units (FXMQ-MF) and standard indoor units are connected, the total connection capacity of the outdoor-air processing units (FXMQ-MF) must not exceed 30% of the capacity index of the outdoor units. And the connection ratio must not exceed 100%.
  - \*3. For indoor units used for cooling only (do not connect to Branch Selector unit when using for heat recovery), total capacity index of cooling only indoor units must be 50% or less than the total capacity index of the outdoor units.

## 4.2 Outdoor Unit Combinations

Capacity range (Ton)	6	8	10	12	14	16	18
REYQ	72AA	96AA	120AA	144AA	168AA	192AA	216AA
Max. number of connectable indoor units	12	16	20	25	29	33	37
Total capacity index of indoor units to be connected *1	36-93 (144)	48-124 (192)	60-156 (240)	72-187 (288)	84-218 (336)	96-249 (346)	108-280 (389)

Capacity range (Ton)	20	22	24	26	28	30	32
REYQ	240AA	264AA	288AA	312AA	336AA	360AA	384AA
Max. number of connectable indoor units	41	45	49	54	58	62	64
Total capacity index of indoor units to be connected *1	120-312 (432)	132-343 (422)	144-374 (461)	156-405 (499)	168-436 (538)	180-468 (576)	192-499 (614)

Capacity range (Ton)	34	36	38	40
REYQ	408AA	432AA	456AA	480AA
Max. number of connectable indoor units	64	64	64	64
Total capacity index of indoor units to be connected *1	204-530 (653)	216-561 (691)	228-592 (730)	240-624 (768)

**Notes:** \*1. Values inside brackets are based on connection of indoor units rated at maximum capacity, 200% for REYQ72-168AA, 180% for REYQ192-240AA, and 160% for REYQ264-480AA.

## 4.3 Limitation of Capacity Index for Heat Recovery

### Single Branch Selector Unit

Model	BSQ36TVJ BSQ36TAVJ	BSQ60TVJ BSQ60TAVJ	BSQ96TVJ BSQ96TAVJ
Maximum number of connectable indoor units	4	8	8
Total capacity index of connectable indoor units	36 or less	More than 36 and 60 or less	More than 60 and 96 or less

### Multi Branch Selector Unit (Standard Series)

Model	BS4Q54TVJ BS4Q54TAVJ	BS6Q54TVJ	BS8Q54TVJ	BS10Q54TVJ BS10Q54TAVJ	BS12Q54TVJ BS12Q54TAVJ
Maximum number of connectable indoor units per branch	5	5	5	5	5
Number of branches	4	6	8	10	12
Maximum capacity index of connectable indoor units	144 or less	216 or less	290 or less	290 or less	290 or less
Maximum capacity index of connectable indoor units per branch *1	54 or less	54 or less	54 or less	54 or less	54 or less

### Multi Branch Selector Unit (Flex Series)

Model		BSF4Q54TVJ	BSF6Q54TVJ	BSF8Q54TVJ
Maximum number of connectable indoor units per branch		5	5	5
Number of branches		4	6	8
Maximum capacity index of connectable indoor units per branch *1		54 or less	54 or less	54 or less
Series configuration	Maximum capacity index of connectable indoor units per branch selector unit	144 or less	162 or less	162 or less
	Maximum capacity index of connectable indoor units with branch selector units connected in series	230 or less	230 or less	230 or less
Parallel configuration	Maximum capacity index of connectable indoor units	144 or less	216 or less	290 or less

**Notes:** \*1. When the total capacity index of indoor units to be connected downstream is larger than 54 (Max. 96), use a joint kit (KHRP26A250T, optional parts) to join 2 branches downstream from the Branch Selector unit.

#### Heat Recovery

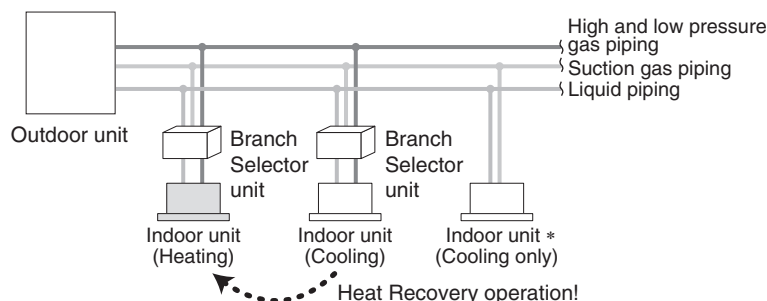

\* For indoor units used for cooling only (do not connect to Branch Selector unit when using for Heat Recovery), total capacity index must be 50% or less than the capacity index of the outdoor units.

## 5. Specifications

### 5.1 REYQ-AATJA, REYQ-AATJB

Model name			REYQ72AATJA	REYQ96AATJA
Power supply			3 phase, 208/230 V, 60 Hz	3 phase, 208/230 V, 60 Hz
★1 Cooling capacity	Nominal	Btu/h (kW)	72,000 (21.1)	96,000 (28.1)
	Rated		69,000 (20.2)	92,000 (27.0)
★2 Heating capacity	Nominal	Btu/h (kW)	81,000 (23.7)	108,000 (31.7)
	Rated		77,000 (22.6)	103,000 (30.2)
Casing color			Ivory white (5Y7.5/1)	Ivory white (5Y7.5/1)
Dimensions: (H × W × D)		in. (mm)	65-3/8 × 36-5/8 × 30-1/8 (1,660 × 930 × 765)	65-3/8 × 48-13/16 × 30-1/8 (1,660 × 1,240 × 765)
Heat exchanger			Cross fin coil	Cross fin coil
Compressor	Type		Hermetically sealed scroll type	Hermetically sealed scroll type
	Volume	m <sup>3</sup> /h	14.3	9.5 + 9.5
	Number of revolutions	r/min	4,212	4,482 + 4,482
	Motor output	kW	4.39	2.74 + 2.74
	Starting method		Soft start	Soft start
Fan	Type		Propeller fan	Propeller fan
	Motor output × Number of units	kW	0.95 × 1	0.65 × 2
	Airflow rate	cfm (m <sup>3</sup> /min)	6,200 (175.6)	8,965 (253.9)
	Drive		Direct drive	Direct drive
Connecting pipes	Liquid pipe	in. (mm)	ϕ 3/8 (9.5) C1220T (brazing connection)	ϕ 3/8 (9.5) C1220T (brazing connection)
	Suction gas pipe	in. (mm)	ϕ 3/4 (19.1) C1220T (brazing connection)	ϕ 7/8 (22.2) C1220T (brazing connection)
	High/Low pressure gas pipe	in. (mm)	ϕ 5/8 (15.9) C1220T (brazing connection)	ϕ 3/4 (19.1) C1220T (brazing connection)
Weight		lbs (kg)	509 (231)	710 (322)
Sound pressure level (Reference data)		dB(A)	58	61
Sound power level (Reference data)		dB	80	82
Safety devices			High pressure switch, Fan driver overload protector, Overcurrent fuse, Inverter overload protector, Leak detecting device	High pressure switch, Fan driver overload protector, Overcurrent fuse, Inverter overload protector, Leak detecting device
Defrost method			Deicer	Deicer
Capacity control		%	7-100	4-100
Refrigerant	Refrigerant name		R-410A	R-410A
	Charge	lbs (kg)	23.4 (10.6)	25.8 (11.7)
	Control		Electronic expansion valve	Electronic expansion valve
Standard accessories			Installation manual, Operation manual, Connection pipes, Clamps	Installation manual, Operation manual, Connection pipes, Clamps
Drawing No.			4D134601A	4D134601A

#### Notes:

- ★1. Indoor temp.: 80°FDB (26.7°CDB), 67°FWB (19.4°CWB) / Outdoor temp.: 95°FDB (35.0°CDB) / Rated capacity is certified under AHRI standard 1230.  
 ★2. Indoor temp.: 70°FDB (21.1°CDB) / Outdoor temp.: 47°FDB (8.3°CDB), 43°FWB (6.1°CWB) / Rated capacity is certified under AHRI standard 1230.



Model name			REYQ120AATJA	REYQ144AATJA
Power supply			3 phase, 208/230 V, 60 Hz	3 phase, 208/230 V, 60 Hz
★1 Cooling capacity	Nominal	Btu/h (kW)	120,000 (35.2)	144,000 (42.2)
	Rated		114,000 (33.4)	138,000 (40.4)
★2 Heating capacity	Nominal	Btu/h (kW)	135,000 (39.6)	162,000 (47.5)
	Rated		129,000 (37.8)	154,000 (45.1)
Casing color			Ivory white (5Y7.5/1)	Ivory white (5Y7.5/1)
Dimensions: (H × W × D)		in. (mm)	65-3/8 × 48-13/16 × 30-1/8 (1,660 × 1,240 × 765)	65-3/8 × 48-13/16 × 30-1/8 (1,660 × 1,240 × 765)
Heat exchanger			Cross fin coil	Cross fin coil
Compressor	Type		Hermetically sealed scroll type	Hermetically sealed scroll type
	Volume	m <sup>3</sup> /h	12.6 + 12.6	11.6 + 18.6
	Number of revolutions	r/min	5,934 + 5,934	5,496 + 5,496
	Motor output	kW	3.63 + 3.63	3.36 + 5.72
	Starting method		Soft start	Soft start
Fan	Type		Propeller fan	Propeller fan
	Motor output × Number of units	kW	0.65 × 2	0.65 × 2
	Airflow rate	cfm (m <sup>3</sup> /min)	8,965 (253.9)	9,675 (274)
	Drive		Direct drive	Direct drive
	Connecting pipes			
	Liquid pipe	in. (mm)	φ 1/2 (12.7) C1220T (brazing connection)	φ 1/2 (12.7) C1220T (brazing connection)
	Suction gas pipe	in. (mm)	φ 1-1/8 (28.6) C1220T (brazing connection)	φ 1-1/8 (28.6) C1220T (brazing connection)
	High/Low pressure gas pipe	in. (mm)	φ 3/4 (19.1) C1220T (brazing connection)	φ 7/8 (22.2) C1220T (brazing connection)
Weight		lbs (kg)	712 (323)	785 (356)
Sound pressure level (Reference data)		dB(A)	61	65
Sound power level (Reference data)		dB	82	84
Safety devices			High pressure switch, Fan driver overload protector, Overcurrent fuse, Inverter overload protector, Leak detecting device	High pressure switch, Fan driver overload protector, Overcurrent fuse, Inverter overload protector, Leak detecting device
Defrost method			Deicer	Deicer
Capacity control		%	3-100	3-100
Refrigerant	Refrigerant name		R-410A	R-410A
	Charge	lbs (kg)	25.8 (11.7)	25.8 (11.7)
	Control		Electronic expansion valve	Electronic expansion valve
Standard accessories			Installation manual, Operation manual, Connection pipes, Clamps	Installation manual, Operation manual, Connection pipes, Clamps
Drawing No.			4D134601A	4D134602A

**Notes:**

- ★1. Indoor temp.: 80°FDB (26.7°CDB), 67°FWB (19.4°CWB) / Outdoor temp.: 95°FDB (35.0°CDB) / Rated capacity is certified under AHRI standard 1230.  
★2. Indoor temp.: 70°FDB (21.1°CDB) / Outdoor temp.: 47°FDB (8.3°CDB), 43°FWB (6.1°CWB) / Rated capacity is certified under AHRI standard 1230.

Model name			REYQ168AATJA	REYQ192AATJA
Power supply			3 phase, 208/230 V, 60 Hz	3 phase, 208/230 V, 60 Hz
★1 Cooling capacity	Nominal	Btu/h (kW)	168,000 (49.2)	192,000 (56.3)
	Rated		160,000 (46.9)	184,000 (53.9)
★2 Heating capacity	Nominal	Btu/h (kW)	189,000 (55.4)	216,000 (63.3)
	Rated		180,000 (52.8)	206,000 (60.4)
Casing color			Ivory white (5Y7.5/1)	Ivory white (5Y7.5/1)
Dimensions: (H × W × D)		in. (mm)	65-3/8 × 48-13/16 × 30-1/8 (1,660 × 1,240 × 765)	65-3/8 × 68-7/8 × 30-1/8 (1,660 × 1,750 × 765)
Heat exchanger			Cross fin coil	Cross fin coil
Compressor	Type		Hermetically sealed scroll type	Hermetically sealed scroll type
	Volume	m <sup>3</sup> /h	14.2 + 22.7	18.9 + 18.9
	Number of revolutions	r/min	6,684 + 6,684	5,586 + 5,586
	Motor output	kW	4.09 + 6.96	5.82 + 5.82
	Starting method		Soft start	Soft start
Fan	Type		Propeller fan	Propeller fan
	Motor output × Number of units	kW	0.65 × 2	0.95 × 2
	Airflow rate	cfm (m <sup>3</sup> /min)	9,675 (274)	13,650 (386.5)
	Drive		Direct drive	Direct drive
	Connecting pipes			
	Liquid pipe	in. (mm)	ϕ 5/8 (15.9) C1220T (brazing connection)	ϕ 5/8 (15.9) C1220T (brazing connection)
	Suction gas pipe	in. (mm)	ϕ 1-1/8 (28.6) C1220T (brazing connection)	ϕ 1-1/8 (28.6) C1220T (brazing connection)
	High/Low pressure gas pipe	in. (mm)	ϕ 7/8 (22.2) C1220T (brazing connection)	ϕ 1-1/8 (28.6) C1220T (brazing connection)
Weight		lbs (kg)	787 (357)	957 (434)
Sound pressure level (Reference data)		dB(A)	65	67
Sound power level (Reference data)		dB	85	87
Safety devices			High pressure switch, Fan driver overload protector, Overcurrent fuse, Inverter overload protector, Leak detecting device	High pressure switch, Fan driver overload protector, Overcurrent fuse, Inverter overload protector, Leak detecting device
Defrost method			Deicer	Deicer
Capacity control		%	2-100	4-100
Refrigerant	Refrigerant name		R-410A	R-410A
	Charge	lbs (kg)	25.8 (11.7)	25.8 (11.7)
	Control		Electronic expansion valve	Electronic expansion valve
Standard accessories			Installation manual, Operation manual, Connection pipes, Clamps	Installation manual, Operation manual, Connection pipes, Clamps
Drawing No.			4D134602A	4D134602A

**Notes:**

- ★1. Indoor temp.: 80°FDB (26.7°CDB), 67°FWB (19.4°CWB) / Outdoor temp.: 95°FDB (35.0°CDB) / Rated capacity is certified under AHRI standard 1230.
- ★2. Indoor temp.: 70°FDB (21.1°CDB) / Outdoor temp.: 47°FDB (8.3°CDB), 43°FWB (6.1°CWB) / Rated capacity is certified under AHRI standard 1230.

Model name			REYQ216AATJA	REYQ240AATJA
Power supply			3 phase, 208/230 V, 60 Hz	3 phase, 208/230 V, 60 Hz
★1 Cooling capacity	Nominal	Btu/h (kW)	216,000 (63.3)	240,000 (70.3)
	Rated		206,000 (60.4)	228,000 (66.8)
★2 Heating capacity	Nominal	Btu/h (kW)	243,000 (71.2)	270,000 (79.1)
	Rated		232,000 (68.0)	256,000 (75.0)
Casing color			Ivory white (5Y7.5/1)	Ivory white (5Y7.5/1)
Dimensions: (H × W × D)		in. (mm)	65-3/8 × 68-7/8 × 30-1/8 (1,660 × 1,750 × 765)	65-3/8 × 68-7/8 × 30-1/8 (1,660 × 1,750 × 765)
Heat exchanger			Cross fin coil	Cross fin coil
Compressor	Type		Hermetically sealed scroll type	Hermetically sealed scroll type
	Volume	m <sup>3</sup> /h	21.3 + 21.3	24.7 + 24.7
	Number of revolutions	r/min	6,294 + 6,294	7,272 + 7,272
	Motor output	kW	6.56 + 6.56	7.58 + 7.58
	Starting method		Soft start	Soft start
Fan	Type		Propeller fan	Propeller fan
	Motor output × Number of units	kW	0.95 × 2	0.95 × 2
	Airflow rate	cfm (m <sup>3</sup> /min)	14,505 (410.8)	14,505 (410.8)
	Drive		Direct drive	Direct drive
	Connecting pipes			
	Liquid pipe	in. (mm)	ϕ 5/8 (15.9) C1220T (brazing connection)	ϕ 5/8 (15.9) C1220T (brazing connection)
	Suction gas pipe	in. (mm)	ϕ 1-1/8 (28.6) C1220T (brazing connection)	ϕ 1-3/8 (34.9) C1220T (brazing connection)
	High/Low pressure gas pipe	in. (mm)	ϕ 1-1/8 (28.6) C1220T (brazing connection)	ϕ 1-1/8 (28.6) C1220T (brazing connection)
Weight		lbs (kg)	957 (434)	957 (434)
Sound pressure level (Reference data)		dB(A)	68	69
Sound power level (Reference data)		dB	90	90
Safety devices			High pressure switch, Fan driver overload protector, Overcurrent fuse, Inverter overload protector, Leak detecting device	High pressure switch, Fan driver overload protector, Overcurrent fuse, Inverter overload protector, Leak detecting device
Defrost method			Deicer	Deicer
Capacity control		%	3-100	3-100
Refrigerant	Refrigerant name		R-410A	R-410A
	Charge	lbs (kg)	25.8 (11.7)	25.8 (11.7)
	Control		Electronic expansion valve	Electronic expansion valve
Standard accessories			Installation manual, Operation manual, Connection pipes, Clamps	Installation manual, Operation manual, Connection pipes, Clamps
Drawing No.			4D134603A	4D134603A

**Notes:**

- ★1. Indoor temp.: 80°FDB (26.7°CDB), 67°FWB (19.4°CWB) / Outdoor temp.: 95°FDB (35.0°CDB) / Rated capacity is certified under AHRI standard 1230.  
★2. Indoor temp.: 70°FDB (21.1°CDB) / Outdoor temp.: 47°FDB (8.3°CDB), 43°FWB (6.1°CWB) / Rated capacity is certified under AHRI standard 1230.

Model name (Combination unit)		REYQ264AATJA		REYQ288AATJA	
Model name (Independent unit)		REYQ120AATJA REYQ144AATJA		REYQ144AATJA REYQ144AATJA	
Power supply		3 phase, 208/230 V, 60 Hz		3 phase, 208/230 V, 60 Hz	
★1 Cooling capacity	Nominal	Btu/h	264,000 (77.4)	Btu/h	288,000 (84.4)
	Rated	(kW)	252,000 (73.9)	(kW)	274,000 (80.3)
★2 Heating capacity	Nominal	Btu/h	297,000 (87.0)	Btu/h	324,000 (95.0)
	Rated	(kW)	282,000 (82.6)	(kW)	294,000 (86.2)
Casing color		Ivory white (5Y7.5/1)		Ivory white (5Y7.5/1)	
Dimensions: (H × W × D)		in. (mm)	65-3/8 × 48-13/16 × 30-1/8 + 65-3/8 × 48-13/16 × 30-1/8 (1,660 × 1,240 × 765 + 1,660 × 1,240 × 765)	in. (mm)	65-3/8 × 48-13/16 × 30-1/8 + 65-3/8 × 48-13/16 × 30-1/8 (1,660 × 1,240 × 765 + 1,660 × 1,240 × 765)
Heat exchanger		Cross fin coil		Cross fin coil	
Compressor	Type	Hermetically sealed scroll type		Hermetically sealed scroll type	
	Volume	m <sup>3</sup> /h	(12.5 + 12.5) + (11.3 + 18.1)	m <sup>3</sup> /h	(10.8 + 17.3) + (10.8 + 17.3)
	Number of revolutions	r/min	(5,892 + 5,892) + (5,334 + 5,334)	r/min	(5,094 + 5,094) + (5,094 + 5,094)
	Motor output	kW	(3.6 + 3.6) + (3.26 + 5.55)	kW	(3.11 + 5.31) + (3.11 + 5.31)
	Starting method	Soft start		Soft start	
Fan	Type	Propeller fan		Propeller fan	
	Motor output × Number of units	kW	0.65 × 2 + 0.65 × 2	kW	0.65 × 2 + 0.65 × 2
	Airflow rate	cfm (m <sup>3</sup> /min)	8,965 (253.9) + 9,675 (274)	cfm (m <sup>3</sup> /min)	9,675 (274) + 9,675 (274)
	Drive	Direct drive		Direct drive	
Connecting pipes	Liquid pipe	in. (mm)	φ 3/4 (19.1) C1220T (brazing connection)	in. (mm)	φ 3/4 (19.1) C1220T (brazing connection)
	Suction gas pipe	in. (mm)	φ 1-3/8 (34.9) C1220T (brazing connection)	in. (mm)	φ 1-3/8 (34.9) C1220T (brazing connection)
	High/Low pressure gas pipe	in. (mm)	φ 1-1/8 (28.6) C1220T (brazing connection)	in. (mm)	φ 1-1/8 (28.6) C1220T (brazing connection)
Weight	lbs (kg)	712 (323) + 785 (356)	lbs (kg)	785 (356) + 785 (356)	
Sound pressure level (Reference data)	dB(A)	67	dB(A)	69	
Sound power level (Reference data)	dB	88	dB	88	
Safety devices	High pressure switch, Fan driver overload protector, Overcurrent fuse, Inverter overload protector, Leak detecting device		High pressure switch, Fan driver overload protector, Overcurrent fuse, Inverter overload protector, Leak detecting device		
Defrost method	Deicer		Deicer		
Capacity control	%	1-100	%	1-100	
Refrigerant	Refrigerant name	R-410A		R-410A	
	Charge	lbs (kg)	25.8 (11.7) + 25.8 (11.7)	lbs (kg)	25.8 (11.7) + 25.8 (11.7)
	Control	Electronic expansion valve		Electronic expansion valve	
Standard accessories	Installation manual, Operation manual, Connection pipes, Clamps		Installation manual, Operation manual, Connection pipes, Clamps		
Drawing No.	4D134604A		4D134604A		

**Notes:**

- ★1. Indoor temp.: 80°FDB (26.7°CDB), 67°FWB (19.4°CWB) / Outdoor temp.: 95°FDB (35.0°CDB) / Rated capacity is certified under AHRI standard 1230.
- ★2. Indoor temp.: 70°FDB (21.1°CDB) / Outdoor temp.: 47°FDB (8.3°CDB), 43°FWB (6.1°CWB) / Rated capacity is certified under AHRI standard 1230.

Model name (Combination unit)			REYQ312AATJA	REYQ336AATJA
Model name (Independent unit)			REYQ144AATJA REYQ168AATJA	REYQ168AATJA REYQ168AATJA
Power supply			3 phase, 208/230 V, 60 Hz	3 phase, 208/230 V, 60 Hz
★1 Cooling capacity	Nominal	Btu/h	312,000 (91.4)	336,000 (98.5)
	Rated	(kW)	296,000 (86.7)	320,000 (93.8)
★2 Heating capacity	Nominal	Btu/h	351,000 (103)	378,000 (111)
	Rated	(kW)	320,000 (93.8)	338,000 (99.1)
Casing color			Ivory white (5Y7.5/1)	Ivory white (5Y7.5/1)
Dimensions: (H × W × D)		in. (mm)	65-3/8 × 48-13/16 × 30-1/8 + 65-3/8 × 48-13/16 × 30-1/8 (1,660 × 1,240 × 765 + 1,660 × 1,240 × 765)	65-3/8 × 48-13/16 × 30-1/8 + 65-3/8 × 48-13/16 × 30-1/8 (1,660 × 1,240 × 765 + 1,660 × 1,240 × 765)
Heat exchanger			Cross fin coil	Cross fin coil
Compressor	Type		Hermetically sealed scroll type	Hermetically sealed scroll type
	Volume	m <sup>3</sup> /h	(11 + 17.6) + (13.1 + 20.9)	(12.9 + 20.6) + (12.9 + 20.6)
	Number of revolutions	r/min	(5,184 + 5,184) + (6,174 + 6,174)	(6,078 + 6,078) + (6,078 + 6,078)
	Motor output	kW	(3.17 + 5.4) + (3.77 + 6.43)	(3.71 + 6.33) + (3.71 + 6.33)
	Starting method		Soft start	Soft start
Fan	Type		Propeller fan	Propeller fan
	Motor output × Number of units	kW	0.65 × 2 + 0.65 × 2	0.65 × 2 + 0.65 × 2
	Airflow rate	cfm (m <sup>3</sup> /min)	9,675 (274) + 9,675 (274)	9,675 (274) + 9,675 (274)
	Drive		Direct drive	Direct drive
Connecting pipes	Liquid pipe	in. (mm)	φ 3/4 (19.1) C1220T (brazing connection)	φ 3/4 (19.1) C1220T (brazing connection)
	Suction gas pipe	in. (mm)	φ 1-3/8 (34.9) C1220T (brazing connection)	φ 1-3/8 (34.9) C1220T (brazing connection)
	High/Low pressure gas pipe	in. (mm)	φ 1-1/8 (28.6) C1220T (brazing connection)	φ 1-1/8 (28.6) C1220T (brazing connection)
Weight		lbs (kg)	785 (356) + 787 (357)	787 (357) + 787 (357)
Sound pressure level (Reference data)		dB(A)	69	69
Sound power level (Reference data)		dB	89	89
Safety devices			High pressure switch, Fan driver overload protector, Overcurrent fuse, Inverter overload protector, Leak detecting device	High pressure switch, Fan driver overload protector, Overcurrent fuse, Inverter overload protector, Leak detecting device
Defrost method			Deicer	Deicer
Capacity control		%	1-100	1-100
Refrigerant	Refrigerant name		R-410A	R-410A
	Charge	lbs (kg)	25.8 (11.7) + 25.8 (11.7)	25.8 (11.7) + 25.8 (11.7)
	Control		Electronic expansion valve	Electronic expansion valve
Standard accessories			Installation manual, Operation manual, Connection pipes, Clamps	Installation manual, Operation manual, Connection pipes, Clamps
Drawing No.			4D134604A	4D134605A

**Notes:**

- ★1. Indoor temp.: 80°FDB (26.7°CDB), 67°FWB (19.4°CWB) / Outdoor temp.: 95°FDB (35.0°CDB) / Rated capacity is certified under AHRI standard 1230.  
★2. Indoor temp.: 70°FDB (21.1°CDB) / Outdoor temp.: 47°FDB (8.3°CDB), 43°FWB (6.1°CWB) / Rated capacity is certified under AHRI standard 1230.

Model name (Combination unit)		REYQ360AATJA		REYQ384AATJA		
Model name (Independent unit)		REYQ168AATJA REYQ192AATJA		REYQ192AATJA REYQ192AATJA		
Power supply		3 phase, 208/230 V, 60 Hz		3 phase, 208/230 V, 60 Hz		
★1 Cooling capacity	Nominal	Btu/h (kW)	360,000 (106)	384,000 (113)		
	Rated		342,000 (100)	364,000 (107)		
★2 Heating capacity	Nominal	Btu/h (kW)	405,000 (119)	432,000 (127)		
	Rated		376,000 (110)	386,000 (113)		
Casing color		Ivory white (5Y7.5/1)		Ivory white (5Y7.5/1)		
Dimensions: (H × W × D)		in. (mm)	65-3/8 × 48-13/16 × 30-1/8 + 65-3/8 × 68-7/8 × 30-1/8 (1,660 × 1,240 × 765 + 1,660 × 1,750 × 765)	65-3/8 × 68-7/8 × 30-1/8 + 65-3/8 × 68-7/8 × 30-1/8 (1,660 × 1,750 × 765 + 1,660 × 1,750 × 765)		
Heat exchanger		Cross fin coil		Cross fin coil		
Compressor	Type	Hermetically sealed scroll type		Hermetically sealed scroll type		
	Volume	m <sup>3</sup> /h	(13.2 + 21.1) + (18 + 18)	(17.2 + 17.2) + (17.2 + 17.2)		
	Number of revolutions	r/min	(6,228 + 6,228) + (5,310 + 5,310)	(5,064 + 5,064) + (5,064 + 5,064)		
	Motor output	kW	(3.81 + 6.49) + (5.53 + 5.53)	(5.27 + 5.27) + (5.27 + 5.27)		
	Starting method	Soft start		Soft start		
Fan	Type	Propeller fan		Propeller fan		
	Motor output × Number of units	kW	0.65 × 2 + 0.95 × 2	0.95 × 2 + 0.95 × 2		
	Airflow rate	cfm (m <sup>3</sup> /min)	9,675 (274) + 13,650 (386.5)	13,650 (386.5) + 13,650 (386.5)		
	Drive	Direct drive		Direct drive		
Connecting pipes	Liquid pipe	in. (mm)	φ 3/4 (19.1) C1220T (brazing connection)	φ 3/4 (19.1) C1220T (brazing connection)		
	Suction gas pipe	in. (mm)	φ 1-5/8 (41.3) C1220T (brazing connection)	φ 1-5/8 (41.3) C1220T (brazing connection)		
	High/Low pressure gas pipe	in. (mm)	φ 1-3/8 (34.9) C1220T (brazing connection)	φ 1-3/8 (34.9) C1220T (brazing connection)		
Weight	lbs (kg)	787 (357) + 957 (434)		957 (434) + 957 (434)		
Sound pressure level (Reference data)	dB(A)	70		71		
Sound power level (Reference data)	dB	91		92		
Safety devices		High pressure switch, Fan driver overload protector, Overcurrent fuse, Inverter overload protector, Leak detecting device		High pressure switch, Fan driver overload protector, Overcurrent fuse, Inverter overload protector, Leak detecting device		
Defrost method		Deicer		Deicer		
Capacity control		%	1-100		1-100	
Refrigerant	Refrigerant name		R-410A		R-410A	
	Charge	lbs (kg)	25.8 (11.7) + 25.8 (11.7)		25.8 (11.7) + 25.8 (11.7)	
	Control		Electronic expansion valve		Electronic expansion valve	
Standard accessories		Installation manual, Operation manual, Connection pipes, Clamps		Installation manual, Operation manual, Connection pipes, Clamps		
Drawing No.		4D134605A		4D134605A		

**Notes:**

- ★1. Indoor temp.: 80°FDB (26.7°CDB), 67°FWB (19.4°CWB) / Outdoor temp.: 95°FDB (35.0°CDB) / Rated capacity is certified under AHRI standard 1230.
- ★2. Indoor temp.: 70°FDB (21.1°CDB) / Outdoor temp.: 47°FDB (8.3°CDB), 43°FWB (6.1°CWB) / Rated capacity is certified under AHRI standard 1230.

Model name (Combination unit)		REYQ408AATJA		REYQ432AATJA	
Model name (Independent unit)		REYQ192AATJA REYQ216AATJA		REYQ216AATJA REYQ216AATJA	
Power supply		3 phase, 208/230 V, 60 Hz		3 phase, 208/230 V, 60 Hz	
★1 Cooling capacity	Nominal	Btu/h	408,000 (120)	Btu/h	432,000 (127)
	Rated	(kW)	388,000 (114)	(kW)	410,000 (120)
★2 Heating capacity	Nominal	Btu/h	459,000 (135)	Btu/h	486,000 (142)
	Rated	(kW)	394,000 (115)	(kW)	404,000 (118)
Casing color		Ivory white (5Y7.5/1)		Ivory white (5Y7.5/1)	
Dimensions: (H × W × D)		in. (mm)	65-3/8 × 68-7/8 × 30-1/8 + 65-3/8 × 68-7/8 × 30-1/8 (1,660 × 1,750 × 765 + 1,660 × 1,750 × 765)	in. (mm)	65-3/8 × 68-7/8 × 30-1/8 + 65-3/8 × 68-7/8 × 30-1/8 (1,660 × 1,750 × 765 + 1,660 × 1,750 × 765)
Heat exchanger		Cross fin coil		Cross fin coil	
Compressor	Type	Hermetically sealed scroll type		Hermetically sealed scroll type	
	Volume	m <sup>3</sup> /h	(16.3 + 16.3) + (18.5 + 18.5)	m <sup>3</sup> /h	(17.7 + 17.7) + (17.7 + 17.7)
	Number of revolutions	r/min	(4,818 + 4,818) + (5,442 + 5,442)	r/min	(5,232 + 5,232) + (5,232 + 5,232)
	Motor output	kW	(5.02 + 5.02) + (5.67 + 5.67)	kW	(5.45 + 5.45) + (5.45 + 5.45)
	Starting method	Soft start		Soft start	
Fan	Type	Propeller fan		Propeller fan	
	Motor output × Number of units	kW	0.95 × 2 + 0.95 × 2	kW	0.95 × 2 + 0.95 × 2
	Airflow rate	cfm (m <sup>3</sup> /min)	13,650 (386.5) + 14,505 (410.8)	cfm (m <sup>3</sup> /min)	14,505 (410.8) + 14,505 (410.8)
	Drive	Direct drive		Direct drive	
Connecting pipes	Liquid pipe	in. (mm)	φ 3/4 (19.1) C1220T (brazing connection)	in. (mm)	φ 3/4 (19.1) C1220T (brazing connection)
	Suction gas pipe	in. (mm)	φ 1-5/8 (41.3) C1220T (brazing connection)	in. (mm)	φ 1-5/8 (41.3) C1220T (brazing connection)
	High/Low pressure gas pipe	in. (mm)	φ 1-3/8 (34.9) C1220T (brazing connection)	in. (mm)	φ 1-3/8 (34.9) C1220T (brazing connection)
Weight	lbs (kg)	957 (434) + 957 (434)	lbs (kg)	957 (434) + 957 (434)	
Sound pressure level (Reference data)	dB(A)	71	dB(A)	72	
Sound power level (Reference data)	dB	93	dB	95	
Safety devices	High pressure switch, Fan driver overload protector, Overcurrent fuse, Inverter overload protector, Leak detecting device		High pressure switch, Fan driver overload protector, Overcurrent fuse, Inverter overload protector, Leak detecting device		
Defrost method	Deicer		Deicer		
Capacity control	%	1-100	%	1-100	
Refrigerant	Refrigerant name	R-410A		R-410A	
	Charge	lbs (kg)	25.8 (11.7) + 25.8 (11.7)	lbs (kg)	25.8 (11.7) + 25.8 (11.7)
	Control	Electronic expansion valve		Electronic expansion valve	
Standard accessories	Installation manual, Operation manual, Connection pipes, Clamps		Installation manual, Operation manual, Connection pipes, Clamps		
Drawing No.	4D134606A		4D134606A		

**Notes:**

- ★1. Indoor temp.: 80°FDB (26.7°CDB), 67°FWB (19.4°CWB) / Outdoor temp.: 95°FDB (35.0°CDB) / Rated capacity is certified under AHRI standard 1230.  
★2. Indoor temp.: 70°FDB (21.1°CDB) / Outdoor temp.: 47°FDB (8.3°CDB), 43°FWB (6.1°CWB) / Rated capacity is certified under AHRI standard 1230.

Model name (Combination unit)		REYQ456AATJA		REYQ480AATJA		
Model name (Independent unit)		REYQ216AATJA REYQ240AATJA		REYQ240AATJA REYQ240AATJA		
Power supply		3 phase, 208/230 V, 60 Hz		3 phase, 208/230 V, 60 Hz		
★1 Cooling capacity	Nominal	Btu/h	456,000 (134)	480,000 (141)		
	Rated	(kW)	434,000 (127)	456,000 (134)		
★2 Heating capacity	Nominal	Btu/h	513,000 (150)	540,000 (158)		
	Rated	(kW)	414,000 (121)	424,000 (124)		
Casing color		Ivory white (5Y7.5/1)		Ivory white (5Y7.5/1)		
Dimensions: (H × W × D)		in. (mm)	65-3/8 × 68-7/8 × 30-1/8 + 65-3/8 × 68-7/8 × 30-1/8 (1,660 × 1,750 × 765 + 1,660 × 1,750 × 765)	65-3/8 × 68-7/8 × 30-1/8 + 65-3/8 × 68-7/8 × 30-1/8 (1,660 × 1,750 × 765 + 1,660 × 1,750 × 765)		
Heat exchanger		Cross fin coil		Cross fin coil		
Compressor	Type	Hermetically sealed scroll type		Hermetically sealed scroll type		
	Volume	m <sup>3</sup> /h	(17.5 + 17.5) + (20 + 20)	(20.4 + 20.4) + (20.4 + 20.4)		
	Number of revolutions	r/min	(5,154 + 5,154) + (5,886 + 5,886)	(6,018 + 6,018) + (6,018 + 6,018)		
	Motor output	kW	(5.37 + 5.37) + (6.13 + 6.13)	(6.27 + 6.27) + (6.27 + 6.27)		
	Starting method	Soft start		Soft start		
Fan	Type	Propeller fan		Propeller fan		
	Motor output × Number of units	kW	0.95 × 2 + 0.95 × 2	0.95 × 2 + 0.95 × 2		
	Airflow rate	cfm (m <sup>3</sup> /min)	14,505 (410.8) + 14,505 (410.8)	14,505 (410.8) + 14,505 (410.8)		
	Drive	Direct drive		Direct drive		
Connecting pipes	Liquid pipe	in. (mm)	φ 3/4 (19.1) C1220T (brazing connection)	φ 3/4 (19.1) C1220T (brazing connection)		
	Suction gas pipe	in. (mm)	φ 1-5/8 (41.3) C1220T (brazing connection)	φ 1-5/8 (41.3) C1220T (brazing connection)		
	High/Low pressure gas pipe	in. (mm)	φ 1-3/8 (34.9) C1220T (brazing connection)	φ 1-3/8 (34.9) C1220T (brazing connection)		
Weight	lbs (kg)	957 (434) + 957 (434)		957 (434) + 957 (434)		
Sound pressure level (Reference data)	dB(A)	72		73		
Sound power level (Reference data)	dB	95		95		
Safety devices		High pressure switch, Fan driver overload protector, Overcurrent fuse, Inverter overload protector, Leak detecting device		High pressure switch, Fan driver overload protector, Overcurrent fuse, Inverter overload protector, Leak detecting device		
Defrost method		Deicer		Deicer		
Capacity control		%	1-100		1-100	
Refrigerant	Refrigerant name		R-410A		R-410A	
	Charge	lbs (kg)	25.8 (11.7) + 25.8 (11.7)		25.8 (11.7) + 25.8 (11.7)	
	Control		Electronic expansion valve		Electronic expansion valve	
Standard accessories		Installation manual, Operation manual, Connection pipes, Clamps		Installation manual, Operation manual, Connection pipes, Clamps		
Drawing No.		4D134606A		4D134607A		

**Notes:**

- ★1. Indoor temp.: 80°FDB (26.7°CDB), 67°FWB (19.4°CWB) / Outdoor temp.: 95°FDB (35.0°CDB) / Rated capacity is certified under AHRI standard 1230.
- ★2. Indoor temp.: 70°FDB (21.1°CDB) / Outdoor temp.: 47°FDB (8.3°CDB), 43°FWB (6.1°CWB) / Rated capacity is certified under AHRI standard 1230.



Model name			REYQ72AATJB	REYQ96AATJB
Power supply			3 phase, 208/230 V, 60 Hz	3 phase, 208/230 V, 60 Hz
★1 Cooling capacity	Nominal	Btu/h (kW)	72,000 (21.1)	96,000 (28.1)
	Rated		69,000 (20.2)	92,000 (27.0)
★2 Heating capacity	Nominal	Btu/h (kW)	81,000 (23.7)	108,000 (31.7)
	Rated		69,000 (20.2)	92,000 (27.0)
Casing color			Ivory white (5Y7.5/1)	Ivory white (5Y7.5/1)
Dimensions: (H × W × D)		in. (mm)	65-3/8 × 36-5/8 × 30-1/8 (1,660 × 930 × 765)	65-3/8 × 48-13/16 × 30-1/8 (1,660 × 1,240 × 765)
Heat exchanger			Cross fin coil	Cross fin coil
Compressor	Type		Hermetically sealed scroll type	Hermetically sealed scroll type
	Volume	m <sup>3</sup> /h	14.3	9.5 + 9.5
	Number of revolutions	r/min	4,212	4,482 + 4,482
	Motor output	kW	4.39	2.74 + 2.74
	Starting method		Soft start	Soft start
Fan	Type		Propeller fan	Propeller fan
	Motor output × Number of units	kW	0.95 × 1	0.65 × 2
	Airflow rate	cfm (m <sup>3</sup> /min)	6,200 (175.6)	8,965 (253.9)
	Drive		Direct drive	Direct drive
	Connecting pipes			
	Liquid pipe	in. (mm)	φ 3/8 (9.5) C1220T (brazing connection)	φ 3/8 (9.5) C1220T (brazing connection)
	Suction gas pipe	in. (mm)	φ 3/4 (19.1) C1220T (brazing connection)	φ 7/8 (22.2) C1220T (brazing connection)
	High/Low pressure gas pipe	in. (mm)	φ 5/8 (15.9) C1220T (brazing connection)	φ 3/4 (19.1) C1220T (brazing connection)
Weight		lbs (kg)	509 (231)	710 (322)
Sound pressure level (Reference data)		dB(A)	58	61
Sound power level (Reference data)		dB	80	82
Safety devices			High pressure switch, Fan driver overload protector, Overcurrent fuse, Inverter overload protector, Leak detecting device	High pressure switch, Fan driver overload protector, Overcurrent fuse, Inverter overload protector, Leak detecting device
Defrost method			Deicer	Deicer
Capacity control		%	7-100	4-100
Refrigerant	Refrigerant name		R-410A	R-410A
	Charge	lbs (kg)	23.4 (10.6)	25.8 (11.7)
	Control		Electronic expansion valve	Electronic expansion valve
Standard accessories			Installation manual, Operation manual, Connection pipes, Clamps	Installation manual, Operation manual, Connection pipes, Clamps
Drawing No.			4D148467	4D148467

**Notes:**

- ★1. Indoor temp.: 80°FDB (26.7°CDB), 67°FWB (19.4°CWB) / Outdoor temp.: 95°FDB (35.0°CDB) / Rated capacity is certified under AHRI standard 1230.  
★2. Indoor temp.: 70°FDB (21.1°CDB) / Outdoor temp.: 47°FDB (8.3°CDB), 43°FWB (6.1°CWB) / Rated capacity is certified under AHRI standard 1230.

Model name			REYQ120AATJB	REYQ144AATJB
Power supply			3 phase, 208/230 V, 60 Hz	3 phase, 208/230 V, 60 Hz
★1 Cooling capacity	Nominal	Btu/h (kW)	119,000 (34.9)	144,000 (42.2)
	Rated		114,000 (33.4)	138,000 (40.4)
★2 Heating capacity	Nominal	Btu/h (kW)	135,000 (39.6)	162,000 (47.5)
	Rated		114,000 (33.4)	138,000 (40.4)
Casing color			Ivory white (5Y7.5/1)	Ivory white (5Y7.5/1)
Dimensions: (H × W × D)		in. (mm)	65-3/8 × 48-13/16 × 30-1/8 (1,660 × 1,240 × 765)	65-3/8 × 48-13/16 × 30-1/8 (1,660 × 1,240 × 765)
Heat exchanger			Cross fin coil	Cross fin coil
Compressor	Type		Hermetically sealed scroll type	Hermetically sealed scroll type
	Volume	m <sup>3</sup> /h	12.6 + 12.6	11.6 + 18.6
	Number of revolutions	r/min	5,934 + 5,934	5,496 + 5,496
	Motor output	kW	3.63 + 3.63	3.36 + 5.72
	Starting method		Soft start	Soft start
Fan	Type		Propeller fan	Propeller fan
	Motor output × Number of units	kW	0.65 × 2	0.65 × 2
	Airflow rate	cfm (m <sup>3</sup> /min)	8,965 (253.9)	9,675 (274)
	Drive		Direct drive	Direct drive
	Connecting pipes			
	Liquid pipe	in. (mm)	φ 1/2 (12.7) C1220T (brazing connection)	φ 1/2 (12.7) C1220T (brazing connection)
	Suction gas pipe	in. (mm)	φ 1-1/8 (28.6) C1220T (brazing connection)	φ 1-1/8 (28.6) C1220T (brazing connection)
	High/Low pressure gas pipe	in. (mm)	φ 3/4 (19.1) C1220T (brazing connection)	φ 7/8 (22.2) C1220T (brazing connection)
Weight		lbs (kg)	712 (323)	785 (356)
Sound pressure level (Reference data)		dB(A)	61	65
Sound power level (Reference data)		dB	82	84
Safety devices			High pressure switch, Fan driver overload protector, Overcurrent fuse, Inverter overload protector, Leak detecting device	High pressure switch, Fan driver overload protector, Overcurrent fuse, Inverter overload protector, Leak detecting device
Defrost method			Deicer	Deicer
Capacity control		%	3-100	3-100
Refrigerant	Refrigerant name		R-410A	R-410A
	Charge	lbs (kg)	25.8 (11.7)	25.8 (11.7)
	Control		Electronic expansion valve	Electronic expansion valve
Standard accessories			Installation manual, Operation manual, Connection pipes, Clamps	Installation manual, Operation manual, Connection pipes, Clamps
Drawing No.			4D148467	4D148468

**Notes:**

- ★1. Indoor temp.: 80°FDB (26.7°CDB), 67°FWB (19.4°CWB) / Outdoor temp.: 95°FDB (35.0°CDB) / Rated capacity is certified under AHRI standard 1230.
- ★2. Indoor temp.: 70°FDB (21.1°CDB) / Outdoor temp.: 47°FDB (8.3°CDB), 43°FWB (6.1°CWB) / Rated capacity is certified under AHRI standard 1230.

Model name			REYQ168AATJB	REYQ192AATJB
Power supply			3 phase, 208/230 V, 60 Hz	3 phase, 208/230 V, 60 Hz
★1 Cooling capacity	Nominal	Btu/h (kW)	162,000 (47.5)	192,000 (56.3)
	Rated		156,000 (45.7)	184,000 (53.9)
★2 Heating capacity	Nominal	Btu/h (kW)	189,000 (55.4)	216,000 (63.3)
	Rated		156,000 (45.7)	184,000 (53.9)
Casing color			Ivory white (5Y7.5/1)	Ivory white (5Y7.5/1)
Dimensions: (H × W × D)		in. (mm)	65-3/8 × 48-13/16 × 30-1/8 (1,660 × 1,240 × 765)	65-3/8 × 68-7/8 × 30-1/8 (1,660 × 1,750 × 765)
Heat exchanger			Cross fin coil	Cross fin coil
Compressor	Type		Hermetically sealed scroll type	Hermetically sealed scroll type
	Volume	m <sup>3</sup> /h	14.2 + 22.7	18.9 + 18.9
	Number of revolutions	r/min	6,684 + 6,684	5,586 + 5,586
	Motor output	kW	4.09 + 6.96	5.82 + 5.82
	Starting method		Soft start	Soft start
Fan	Type		Propeller fan	Propeller fan
	Motor output × Number of units	kW	0.65 × 2	0.95 × 2
	Airflow rate	cfm (m <sup>3</sup> /min)	9,675 (274)	13,650 (386.5)
	Drive		Direct drive	Direct drive
	Connecting pipes			
	Liquid pipe	in. (mm)	ϕ 5/8 (15.9) C1220T (brazing connection)	ϕ 5/8 (15.9) C1220T (brazing connection)
	Suction gas pipe	in. (mm)	ϕ 1-1/8 (28.6) C1220T (brazing connection)	ϕ 1-1/8 (28.6) C1220T (brazing connection)
	High/Low pressure gas pipe	in. (mm)	ϕ 7/8 (22.2) C1220T (brazing connection)	ϕ 1-1/8 (28.6) C1220T (brazing connection)
Weight		lbs (kg)	787 (357)	957 (434)
Sound pressure level (Reference data)		dB(A)	65	67
Sound power level (Reference data)		dB	85	87
Safety devices			High pressure switch, Fan driver overload protector, Overcurrent fuse, Inverter overload protector, Leak detecting device	High pressure switch, Fan driver overload protector, Overcurrent fuse, Inverter overload protector, Leak detecting device
Defrost method			Deicer	Deicer
Capacity control		%	2-100	4-100
Refrigerant	Refrigerant name		R-410A	R-410A
	Charge	lbs (kg)	25.8 (11.7)	25.8 (11.7)
	Control		Electronic expansion valve	Electronic expansion valve
Standard accessories			Installation manual, Operation manual, Connection pipes, Clamps	Installation manual, Operation manual, Connection pipes, Clamps
Drawing No.			4D148468	4D148468

**Notes:**

- ★1. Indoor temp.: 80°FDB (26.7°CDB), 67°FWB (19.4°CWB) / Outdoor temp.: 95°FDB (35.0°CDB) / Rated capacity is certified under AHRI standard 1230.  
★2. Indoor temp.: 70°FDB (21.1°CDB) / Outdoor temp.: 47°FDB (8.3°CDB), 43°FWB (6.1°CWB) / Rated capacity is certified under AHRI standard 1230.

Model name			REYQ216AATJB	REYQ240AATJB
Power supply			3 phase, 208/230 V, 60 Hz	3 phase, 208/230 V, 60 Hz
★1 Cooling capacity	Nominal	Btu/h (kW)	216,000 (63.3)	238,000 (69.8)
	Rated		206,000 (60.4)	228,000 (66.8)
★2 Heating capacity	Nominal	Btu/h (kW)	243,000 (71.2)	270,000 (79.1)
	Rated		206,000 (60.4)	220,000 (64.5)
Casing color			Ivory white (5Y7.5/1)	Ivory white (5Y7.5/1)
Dimensions: (H × W × D)		in. (mm)	65-3/8 × 68-7/8 × 30-1/8 (1,660 × 1,750 × 765)	65-3/8 × 68-7/8 × 30-1/8 (1,660 × 1,750 × 765)
Heat exchanger			Cross fin coil	Cross fin coil
Compressor	Type		Hermetically sealed scroll type	Hermetically sealed scroll type
	Volume	m <sup>3</sup> /h	21.3 + 21.3	24.7 + 24.7
	Number of revolutions	r/min	6,294 + 6,294	7,272 + 7,272
	Motor output	kW	6.56 + 6.56	7.58 + 7.58
	Starting method		Soft start	Soft start
Fan	Type		Propeller fan	Propeller fan
	Motor output × Number of units	kW	0.95 × 2	0.95 × 2
	Airflow rate	cfm (m <sup>3</sup> /min)	14,505 (410.8)	14,505 (410.8)
	Drive		Direct drive	Direct drive
	Connecting pipes			
	Liquid pipe	in. (mm)	ϕ 5/8 (15.9) C1220T (brazing connection)	ϕ 5/8 (15.9) C1220T (brazing connection)
	Suction gas pipe	in. (mm)	ϕ 1-1/8 (28.6) C1220T (brazing connection)	ϕ 1-3/8 (34.9) C1220T (brazing connection)
	High/Low pressure gas pipe	in. (mm)	ϕ 1-1/8 (28.6) C1220T (brazing connection)	ϕ 1-1/8 (28.6) C1220T (brazing connection)
Weight		lbs (kg)	957 (434)	957 (434)
Sound pressure level (Reference data)		dB(A)	68	69
Sound power level (Reference data)		dB	90	90
Safety devices			High pressure switch, Fan driver overload protector, Overcurrent fuse, Inverter overload protector, Leak detecting device	High pressure switch, Fan driver overload protector, Overcurrent fuse, Inverter overload protector, Leak detecting device
Defrost method			Deicer	Deicer
Capacity control		%	3-100	3-100
Refrigerant	Refrigerant name		R-410A	R-410A
	Charge	lbs (kg)	25.8 (11.7)	25.8 (11.7)
	Control		Electronic expansion valve	Electronic expansion valve
Standard accessories			Installation manual, Operation manual, Connection pipes, Clamps	Installation manual, Operation manual, Connection pipes, Clamps
Drawing No.			4D148469	4D148469

**Notes:**

- ★1. Indoor temp.: 80°FDB (26.7°CDB), 67°FWB (19.4°CWB) / Outdoor temp.: 95°FDB (35.0°CDB) / Rated capacity is certified under AHRI standard 1230.
- ★2. Indoor temp.: 70°FDB (21.1°CDB) / Outdoor temp.: 47°FDB (8.3°CDB), 43°FWB (6.1°CWB) / Rated capacity is certified under AHRI standard 1230.

Model name (Combination unit)		REYQ264AATJB		REYQ288AATJB		
Model name (Independent unit)		REYQ120AATJB REYQ144AATJB		REYQ144AATJB REYQ144AATJB		
Power supply		3 phase, 208/230 V, 60 Hz		3 phase, 208/230 V, 60 Hz		
★1 Cooling capacity	Nominal	Btu/h	264,000 (77.4)	286,000 (83.8)		
	Rated	(kW)	252,000 (73.9)	274,000 (80.3)		
★2 Heating capacity	Nominal	Btu/h	297,000 (87.0)	324,000 (95.0)		
	Rated	(kW)	252,000 (73.9)	274,000 (80.3)		
Casing color		Ivory white (5Y7.5/1)		Ivory white (5Y7.5/1)		
Dimensions: (H × W × D)		in. (mm)	65-3/8 × 48-13/16 × 30-1/8 + 65-3/8 × 48-13/16 × 30-1/8 (1,660 × 1,240 × 765 + 1,660 × 1,240 × 765)	65-3/8 × 48-13/16 × 30-1/8 + 65-3/8 × 48-13/16 × 30-1/8 (1,660 × 1,240 × 765 + 1,660 × 1,240 × 765)		
Heat exchanger		Cross fin coil		Cross fin coil		
Compressor	Type	Hermetically sealed scroll type		Hermetically sealed scroll type		
	Volume	m <sup>3</sup> /h	(12.5 + 12.5) + (11.3 + 18.1)	(10.8 + 17.3) + (10.8 + 17.3)		
	Number of revolutions	r/min	(5,892 + 5,892) + (5,334 + 5,334)	(5,094 + 5,094) + (5,094 + 5,094)		
	Motor output	kW	(3.6 + 3.6) + (3.26 + 5.55)	(3.11 + 5.31) + (3.11 + 5.31)		
Starting method		Soft start		Soft start		
Fan	Type	Propeller fan		Propeller fan		
	Motor output × Number of units	kW	0.65 × 2 + 0.65 × 2	0.65 × 2 + 0.65 × 2		
	Airflow rate	cfm (m <sup>3</sup> /min)	8,965 (253.9) + 9,675 (274)	9,675 (274) + 9,675 (274)		
	Drive	Direct drive		Direct drive		
Connecting pipes	Liquid pipe	in. (mm)	φ 3/4 (19.1) C1220T (brazing connection)	φ 3/4 (19.1) C1220T (brazing connection)		
	Suction gas pipe	in. (mm)	φ 1-3/8 (34.9) C1220T (brazing connection)	φ 1-3/8 (34.9) C1220T (brazing connection)		
	High/Low pressure gas pipe	in. (mm)	φ 1-1/8 (28.6) C1220T (brazing connection)	φ 1-1/8 (28.6) C1220T (brazing connection)		
Weight	lbs (kg)	712 (323) + 785 (356)		785 (356) + 785 (356)		
Sound pressure level (Reference data)	dB(A)	67		69		
Sound power level (Reference data)	dB	88		88		
Safety devices		High pressure switch, Fan driver overload protector, Overcurrent fuse, Inverter overload protector, Leak detecting device		High pressure switch, Fan driver overload protector, Overcurrent fuse, Inverter overload protector, Leak detecting device		
Defrost method		Deicer		Deicer		
Capacity control		%	1-100		1-100	
Refrigerant	Refrigerant name		R-410A		R-410A	
	Charge	lbs (kg)	25.8 (11.7) + 25.8 (11.7)		25.8 (11.7) + 25.8 (11.7)	
	Control		Electronic expansion valve		Electronic expansion valve	
Standard accessories		Installation manual, Operation manual, Connection pipes, Clamps		Installation manual, Operation manual, Connection pipes, Clamps		
Drawing No.		4D148470		4D148470		

**Notes:**

- ★1. Indoor temp.: 80°FDB (26.7°CDB), 67°FWB (19.4°CWB) / Outdoor temp.: 95°FDB (35.0°CDB) / Rated capacity is certified under AHRI standard 1230.  
★2. Indoor temp.: 70°FDB (21.1°CDB) / Outdoor temp.: 47°FDB (8.3°CDB), 43°FWB (6.1°CWB) / Rated capacity is certified under AHRI standard 1230.

Model name (Combination unit)		REYQ312AATJB		REYQ336AATJB	
Model name (Independent unit)		REYQ144AATJB REYQ168AATJB		REYQ168AATJB REYQ168AATJB	
Power supply		3 phase, 208/230 V, 60 Hz		3 phase, 208/230 V, 60 Hz	
★1 Cooling capacity	Nominal	Btu/h	310,000 (90.9)	Btu/h	330,000 (96.7)
	Rated	(kW)	296,000 (86.7)	(kW)	316,000 (92.6)
★2 Heating capacity	Nominal	Btu/h	351,000 (103)	Btu/h	378,000 (111)
	Rated	(kW)	296,000 (86.7)	(kW)	310,000 (90.9)
Casing color		Ivory white (5Y7.5/1)		Ivory white (5Y7.5/1)	
Dimensions: (H × W × D)		in. (mm)	65-3/8 × 48-13/16 × 30-1/8 + 65-3/8 × 48-13/16 × 30-1/8 (1,660 × 1,240 × 765 + 1,660 × 1,240 × 765)	in. (mm)	65-3/8 × 48-13/16 × 30-1/8 + 65-3/8 × 48-13/16 × 30-1/8 (1,660 × 1,240 × 765 + 1,660 × 1,240 × 765)
Heat exchanger		Cross fin coil		Cross fin coil	
Compressor	Type	Hermetically sealed scroll type		Hermetically sealed scroll type	
	Volume	m <sup>3</sup> /h	(11 + 17.6) + (13.1 + 20.9)	m <sup>3</sup> /h	(12.9 + 20.6) + (12.9 + 20.6)
	Number of revolutions	r/min	(5,184 + 5,184) + (6,174 + 6,174)	r/min	(6,078 + 6,078) + (6,078 + 6,078)
	Motor output	kW	(3.17 + 5.4) + (3.77 + 6.43)	kW	(3.71 + 6.33) + (3.71 + 6.33)
	Starting method	Soft start		Soft start	
Fan	Type	Propeller fan		Propeller fan	
	Motor output × Number of units	kW	0.65 × 2 + 0.65 × 2	kW	0.65 × 2 + 0.65 × 2
	Airflow rate	cfm (m <sup>3</sup> /min)	9,675 (274) + 9,675 (274)	cfm (m <sup>3</sup> /min)	9,675 (274) + 9,675 (274)
	Drive	Direct drive		Direct drive	
Connecting pipes	Liquid pipe	in. (mm)	φ 3/4 (19.1) C1220T (brazing connection)	in. (mm)	φ 3/4 (19.1) C1220T (brazing connection)
	Suction gas pipe	in. (mm)	φ 1-3/8 (34.9) C1220T (brazing connection)	in. (mm)	φ 1-3/8 (34.9) C1220T (brazing connection)
	High/Low pressure gas pipe	in. (mm)	φ 1-1/8 (28.6) C1220T (brazing connection)	in. (mm)	φ 1-1/8 (28.6) C1220T (brazing connection)
Weight	lbs (kg)	785 (356) + 787 (357)	lbs (kg)	787 (357) + 787 (357)	
Sound pressure level (Reference data)	dB(A)	69		dB(A)	69
Sound power level (Reference data)	dB	89		dB	89
Safety devices		High pressure switch, Fan driver overload protector, Overcurrent fuse, Inverter overload protector, Leak detecting device		High pressure switch, Fan driver overload protector, Overcurrent fuse, Inverter overload protector, Leak detecting device	
Defrost method		Deicer		Deicer	
Capacity control		%		%	
Refrigerant		R-410A		R-410A	
Refrigerant	Refrigerant name	R-410A		R-410A	
	Charge	lbs (kg)	25.8 (11.7) + 25.8 (11.7)	lbs (kg)	25.8 (11.7) + 25.8 (11.7)
Control		Electronic expansion valve		Electronic expansion valve	
Standard accessories		Installation manual, Operation manual, Connection pipes, Clamps		Installation manual, Operation manual, Connection pipes, Clamps	
Drawing No.		4D148470		4D148471	

**Notes:**

- ★1. Indoor temp.: 80°FDB (26.7°CDB), 67°FWB (19.4°CWB) / Outdoor temp.: 95°FDB (35.0°CDB) / Rated capacity is certified under AHRI standard 1230.
- ★2. Indoor temp.: 70°FDB (21.1°CDB) / Outdoor temp.: 47°FDB (8.3°CDB), 43°FWB (6.1°CWB) / Rated capacity is certified under AHRI standard 1230.

Model name (Combination unit)		REYQ360AATJB		REYQ384AATJB	
Model name (Independent unit)		REYQ168AATJB REYQ192AATJB		REYQ192AATJB REYQ192AATJB	
Power supply		3 phase, 208/230 V, 60 Hz		3 phase, 208/230 V, 60 Hz	
★1 Cooling capacity	Nominal	Btu/h	358,000 (105)	Btu/h	382,000 (112)
	Rated	(kW)	342,000 (100)	(kW)	364,000 (107)
★2 Heating capacity	Nominal	Btu/h	405,000 (119)	Btu/h	432,000 (127)
	Rated	(kW)	342,000 (100)	(kW)	364,000 (107)
Casing color		Ivory white (5Y7.5/1)		Ivory white (5Y7.5/1)	
Dimensions: (H × W × D)		in. (mm)	65-3/8 × 48-13/16 × 30-1/8 + 65-3/8 × 68-7/8 × 30-1/8 (1,660 × 1,240 × 765 + 1,660 × 1,750 × 765)	in. (mm)	65-3/8 × 68-7/8 × 30-1/8 + 65-3/8 × 68-7/8 × 30-1/8 (1,660 × 1,750 × 765 + 1,660 × 1,750 × 765)
Heat exchanger		Cross fin coil		Cross fin coil	
Compressor	Type	Hermetically sealed scroll type		Hermetically sealed scroll type	
	Volume	m <sup>3</sup> /h	(13.2 + 21.1) + (18 + 18)	m <sup>3</sup> /h	(17.2 + 17.2) + (17.2 + 17.2)
	Number of revolutions	r/min	(6,228 + 6,228) + (5,310 + 5,310)	r/min	(5,064 + 5,064) + (5,064 + 5,064)
	Motor output	kW	(3.81 + 6.49) + (5.53 + 5.53)	kW	(5.27 + 5.27) + (5.27 + 5.27)
	Starting method	Soft start		Soft start	
Fan	Type	Propeller fan		Propeller fan	
	Motor output × Number of units	kW	0.65 × 2 + 0.95 × 2	kW	0.95 × 2 + 0.95 × 2
	Airflow rate	cfm (m <sup>3</sup> /min)	9,675 (274) + 13,650 (386.5)	cfm (m <sup>3</sup> /min)	13,650 (386.5) + 13,650 (386.5)
	Drive	Direct drive		Direct drive	
Connecting pipes	Liquid pipe	in. (mm)	φ 3/4 (19.1) C1220T (brazing connection)	in. (mm)	φ 3/4 (19.1) C1220T (brazing connection)
	Suction gas pipe	in. (mm)	φ 1-5/8 (41.3) C1220T (brazing connection)	in. (mm)	φ 1-5/8 (41.3) C1220T (brazing connection)
	High/Low pressure gas pipe	in. (mm)	φ 1-3/8 (34.9) C1220T (brazing connection)	in. (mm)	φ 1-3/8 (34.9) C1220T (brazing connection)
Weight	lbs (kg)	787 (357) + 957 (434)	lbs (kg)	957 (434) + 957 (434)	
Sound pressure level (Reference data)	dB(A)	70	dB(A)	71	
Sound power level (Reference data)	dB	91	dB	92	
Safety devices	High pressure switch, Fan driver overload protector, Overcurrent fuse, Inverter overload protector, Leak detecting device		High pressure switch, Fan driver overload protector, Overcurrent fuse, Inverter overload protector, Leak detecting device		
Defrost method	Deicer		Deicer		
Capacity control	%	1-100	%	1-100	
Refrigerant	Refrigerant name	R-410A		Refrigerant name	R-410A
	Charge	lbs (kg)	25.8 (11.7) + 25.8 (11.7)	lbs (kg)	25.8 (11.7) + 25.8 (11.7)
	Control	Electronic expansion valve		Electronic expansion valve	
Standard accessories	Installation manual, Operation manual, Connection pipes, Clamps		Installation manual, Operation manual, Connection pipes, Clamps		
Drawing No.	4D148471		4D148471		

**Notes:**

- ★1. Indoor temp.: 80°FDB (26.7°CDB), 67°FWB (19.4°CWB) / Outdoor temp.: 95°FDB (35.0°CDB) / Rated capacity is certified under AHRI standard 1230.  
★2. Indoor temp.: 70°FDB (21.1°CDB) / Outdoor temp.: 47°FDB (8.3°CDB), 43°FWB (6.1°CWB) / Rated capacity is certified under AHRI standard 1230.

Model name (Combination unit)		REYQ408AATJB		REYQ432AATJB	
Model name (Independent unit)		REYQ192AATJB REYQ216AATJB		REYQ216AATJB REYQ216AATJB	
Power supply		3 phase, 208/230 V, 60 Hz		3 phase, 208/230 V, 60 Hz	
★1 Cooling capacity	Nominal	Btu/h	406,000 (119)	Btu/h	430,000 (126)
	Rated	(kW)	388,000 (114)	(kW)	410,000 (120)
★2 Heating capacity	Nominal	Btu/h	459,000 (135)	Btu/h	486,000 (142)
	Rated	(kW)	388,000 (114)	(kW)	404,000 (118)
Casing color		Ivory white (5Y7.5/1)		Ivory white (5Y7.5/1)	
Dimensions: (H × W × D)		in. (mm)	65-3/8 × 68-7/8 × 30-1/8 + 65-3/8 × 68-7/8 × 30-1/8 (1,660 × 1,750 × 765 + 1,660 × 1,750 × 765)	in. (mm)	65-3/8 × 68-7/8 × 30-1/8 + 65-3/8 × 68-7/8 × 30-1/8 (1,660 × 1,750 × 765 + 1,660 × 1,750 × 765)
Heat exchanger		Cross fin coil		Cross fin coil	
Compressor	Type	Hermetically sealed scroll type		Hermetically sealed scroll type	
	Volume	m <sup>3</sup> /h	(16.3 + 16.3) + (18.5 + 18.5)	m <sup>3</sup> /h	(17.7 + 17.7) + (17.7 + 17.7)
	Number of revolutions	r/min	(4,818 + 4,818) + (5,442 + 5,442)	r/min	(5,232 + 5,232) + (5,232 + 5,232)
	Motor output	kW	(5.02 + 5.02) + (5.67 + 5.67)	kW	(5.45 + 5.45) + (5.45 + 5.45)
	Starting method	Soft start		Soft start	
Fan	Type	Propeller fan		Propeller fan	
	Motor output × Number of units	kW	0.95 × 2 + 0.95 × 2	kW	0.95 × 2 + 0.95 × 2
	Airflow rate	cfm (m <sup>3</sup> /min)	13,650 (386.5) + 14,505 (410.8)	cfm (m <sup>3</sup> /min)	14,505 (410.8) + 14,505 (410.8)
	Drive	Direct drive		Direct drive	
Connecting pipes	Liquid pipe	in. (mm)	φ 3/4 (19.1) C1220T (brazing connection)	in. (mm)	φ 3/4 (19.1) C1220T (brazing connection)
	Suction gas pipe	in. (mm)	φ 1-5/8 (41.3) C1220T (brazing connection)	in. (mm)	φ 1-5/8 (41.3) C1220T (brazing connection)
	High/Low pressure gas pipe	in. (mm)	φ 1-3/8 (34.9) C1220T (brazing connection)	in. (mm)	φ 1-3/8 (34.9) C1220T (brazing connection)
Weight	lbs (kg)	957 (434) + 957 (434)	lbs (kg)	957 (434) + 957 (434)	
Sound pressure level (Reference data)	dB(A)	71	dB(A)	72	
Sound power level (Reference data)	dB	93	dB	95	
Safety devices	High pressure switch, Fan driver overload protector, Overcurrent fuse, Inverter overload protector, Leak detecting device		High pressure switch, Fan driver overload protector, Overcurrent fuse, Inverter overload protector, Leak detecting device		
Defrost method	Deicer		Deicer		
Capacity control	%	1-100	%	1-100	
Refrigerant	Refrigerant name	R-410A		Refrigerant name	R-410A
	Charge	lbs (kg)	25.8 (11.7) + 25.8 (11.7)	lbs (kg)	25.8 (11.7) + 25.8 (11.7)
	Control	Electronic expansion valve		Electronic expansion valve	
Standard accessories	Installation manual, Operation manual, Connection pipes, Clamps		Installation manual, Operation manual, Connection pipes, Clamps		
Drawing No.	4D148472		4D148472		

**Notes:**

- ★1. Indoor temp.: 80°FDB (26.7°CDB), 67°FWB (19.4°CWB) / Outdoor temp.: 95°FDB (35.0°CDB) / Rated capacity is certified under AHRI standard 1230.
- ★2. Indoor temp.: 70°FDB (21.1°CDB) / Outdoor temp.: 47°FDB (8.3°CDB), 43°FWB (6.1°CWB) / Rated capacity is certified under AHRI standard 1230.



Model name (Combination unit)		REYQ456AATJB		REYQ480AATJB	
Model name (Independent unit)		REYQ216AATJB REYQ240AATJB		REYQ240AATJB REYQ240AATJB	
Power supply		3 phase, 208/230 V, 60 Hz		3 phase, 208/230 V, 60 Hz	
★1 Cooling capacity	Nominal	Btu/h	454,000 (133)	Btu/h	472,000 (138)
	Rated	(kW)	434,000 (127)	(kW)	450,000 (132)
★2 Heating capacity	Nominal	Btu/h	513,000 (150)	Btu/h	540,000 (158)
	Rated	(kW)	414,000 (121)	(kW)	418,000 (123)
Casing color		Ivory white (5Y7.5/1)		Ivory white (5Y7.5/1)	
Dimensions: (H × W × D)		in. (mm)	65-3/8 × 68-7/8 × 30-1/8 + 65-3/8 × 68-7/8 × 30-1/8 (1,660 × 1,750 × 765 + 1,660 × 1,750 × 765)	in. (mm)	65-3/8 × 68-7/8 × 30-1/8 + 65-3/8 × 68-7/8 × 30-1/8 (1,660 × 1,750 × 765 + 1,660 × 1,750 × 765)
Heat exchanger		Cross fin coil		Cross fin coil	
Compressor	Type	Hermetically sealed scroll type		Hermetically sealed scroll type	
	Volume	m <sup>3</sup> /h	(17.5 + 17.5) + (20 + 20)	m <sup>3</sup> /h	(20.4 + 20.4) + (20.4 + 20.4)
	Number of revolutions	r/min	(5,154 + 5,154) + (5,886 + 5,886)	r/min	(6,018 + 6,018) + (6,018 + 6,018)
	Motor output	kW	(5.37 + 5.37) + (6.13 + 6.13)	kW	(6.27 + 6.27) + (6.27 + 6.27)
	Starting method	Soft start		Soft start	
Fan	Type	Propeller fan		Propeller fan	
	Motor output × Number of units	kW	0.95 × 2 + 0.95 × 2	kW	0.95 × 2 + 0.95 × 2
	Airflow rate	cfm (m <sup>3</sup> /min)	14,505 (410.8) + 14,505 (410.8)	cfm (m <sup>3</sup> /min)	14,505 (410.8) + 14,505 (410.8)
	Drive	Direct drive		Direct drive	
Connecting pipes	Liquid pipe	in. (mm)	φ 3/4 (19.1) C1220T (brazing connection)	in. (mm)	φ 3/4 (19.1) C1220T (brazing connection)
	Suction gas pipe	in. (mm)	φ 1-5/8 (41.3) C1220T (brazing connection)	in. (mm)	φ 1-5/8 (41.3) C1220T (brazing connection)
	High/Low pressure gas pipe	in. (mm)	φ 1-3/8 (34.9) C1220T (brazing connection)	in. (mm)	φ 1-3/8 (34.9) C1220T (brazing connection)
Weight	lbs (kg)	957 (434) + 957 (434)	lbs (kg)	957 (434) + 957 (434)	
Sound pressure level (Reference data)	dB(A)	72	dB(A)	73	
Sound power level (Reference data)	dB	95	dB	95	
Safety devices	High pressure switch, Fan driver overload protector, Overcurrent fuse, Inverter overload protector, Leak detecting device		High pressure switch, Fan driver overload protector, Overcurrent fuse, Inverter overload protector, Leak detecting device		
Defrost method	Deicer		Deicer		
Capacity control	%	1-100	%	1-100	
Refrigerant	Refrigerant name	R-410A		R-410A	
	Charge	lbs (kg)	25.8 (11.7) + 25.8 (11.7)	lbs (kg)	25.8 (11.7) + 25.8 (11.7)
	Control	Electronic expansion valve		Electronic expansion valve	
Standard accessories	Installation manual, Operation manual, Connection pipes, Clamps		Installation manual, Operation manual, Connection pipes, Clamps		
Drawing No.	4D148472		4D148473		

**Notes:**

★1. Indoor temp.: 80°FDB (26.7°CDB), 67°FWB (19.4°CWB) / Outdoor temp.: 95°FDB (35.0°CDB) / Rated capacity is certified under AHRI standard 1230.

★2. Indoor temp.: 70°FDB (21.1°CDB) / Outdoor temp.: 47°FDB (8.3°CDB), 43°FWB (6.1°CWB) / Rated capacity is certified under AHRI standard 1230.

## 5.2 REYQ-AAYDA, REYQ-AAYDB

Model name			REYQ72AAYDA	REYQ96AAYDA
Power supply			3 phase, 460 V, 60 Hz	3 phase, 460 V, 60 Hz
★1 Cooling capacity	Nominal	Btu/h (kW)	72,000 (21.1)	96,000 (28.1)
	Rated		69,000 (20.2)	92,000 (27.0)
★2 Heating capacity	Nominal	Btu/h (kW)	81,000 (23.7)	108,000 (31.7)
	Rated		77,000 (22.6)	103,000 (30.2)
Casing color			Ivory white (5Y7.5/1)	Ivory white (5Y7.5/1)
Dimensions: (H × W × D)		in. (mm)	65-3/8 × 36-5/8 × 30-1/8 (1,660 × 930 × 765)	65-3/8 × 48-13/16 × 30-1/8 (1,660 × 1,240 × 765)
Heat exchanger			Cross fin coil	Cross fin coil
Compressor	Type		Hermetically sealed scroll type	Hermetically sealed scroll type
	Volume	m <sup>3</sup> /h	14.3	9.5 + 9.5
	Number of revolutions	r/min	4,212	4,482 + 4,482
	Motor output	kW	4.39	2.74 + 2.74
	Starting method		Soft start	Soft start
Fan	Type		Propeller fan	Propeller fan
	Motor output × Number of units	kW	0.95 × 1	0.65 × 2
	Airflow rate	cfm (m <sup>3</sup> /min)	6,200 (175.6)	8,965 (253.9)
	Drive		Direct drive	Direct drive
Connecting pipes	Liquid pipe	in. (mm)	ϕ 3/8 (9.5) C1220T (brazing connection)	ϕ 3/8 (9.5) C1220T (brazing connection)
	Suction gas pipe	in. (mm)	ϕ 3/4 (19.1) C1220T (brazing connection)	ϕ 7/8 (22.2) C1220T (brazing connection)
	High/Low pressure gas pipe	in. (mm)	ϕ 5/8 (15.9) C1220T (brazing connection)	ϕ 3/4 (19.1) C1220T (brazing connection)
Weight		lbs (kg)	525 (238)	725 (329)
Sound pressure level (Reference data)		dB(A)	58	61
Sound power level (Reference data)		dB	80	82
Safety devices			High pressure switch, Fan driver overload protector, Overcurrent fuse, Inverter overload protector, Leak detecting device	High pressure switch, Fan driver overload protector, Overcurrent fuse, Inverter overload protector, Leak detecting device
Defrost method			Deicer	Deicer
Capacity control		%	7-100	4-100
Refrigerant	Refrigerant name		R-410A	R-410A
	Charge	lbs (kg)	23.4 (10.6)	25.8 (11.7)
	Control		Electronic expansion valve	Electronic expansion valve
Standard accessories			Installation manual, Operation manual, Connection pipes, Clamps	Installation manual, Operation manual, Connection pipes, Clamps
Drawing No.			4D134608A	4D134608A

### Notes:

- ★1. Indoor temp.: 80°FDB (26.7°CDB), 67°FWB (19.4°CWB) / Outdoor temp.: 95°FDB (35.0°CDB) / Rated capacity is certified under AHRI standard 1230.  
 ★2. Indoor temp.: 70°FDB (21.1°CDB) / Outdoor temp.: 47°FDB (8.3°CDB), 43°FWB (6.1°CWB) / Rated capacity is certified under AHRI standard 1230.

Model name			REYQ120AAAYDA	REYQ144AAAYDA
Power supply			3 phase, 460 V, 60 Hz	3 phase, 460 V, 60 Hz
★1 Cooling capacity	Nominal	Btu/h (kW)	120,000 (35.2)	144,000 (42.2)
	Rated		114,000 (33.4)	138,000 (40.4)
★2 Heating capacity	Nominal	Btu/h (kW)	135,000 (39.6)	162,000 (47.5)
	Rated		129,000 (37.8)	154,000 (45.1)
Casing color			Ivory white (5Y7.5/1)	Ivory white (5Y7.5/1)
Dimensions: (H × W × D)		in. (mm)	65-3/8 × 48-13/16 × 30-1/8 (1,660 × 1,240 × 765)	65-3/8 × 48-13/16 × 30-1/8 (1,660 × 1,240 × 765)
Heat exchanger			Cross fin coil	Cross fin coil
Compressor	Type		Hermetically sealed scroll type	Hermetically sealed scroll type
	Volume	m <sup>3</sup> /h	12.6 + 12.6	11.6 + 18.6
	Number of revolutions	r/min	5,934 + 5,934	5,496 + 5,496
	Motor output	kW	3.63 + 3.63	3.36 + 5.72
	Starting method		Soft start	Soft start
Fan	Type		Propeller fan	Propeller fan
	Motor output × Number of units	kW	0.65 × 2	0.65 × 2
	Airflow rate	cfm (m <sup>3</sup> /min)	8,965 (253.9)	9,675 (274)
	Drive		Direct drive	Direct drive
	Connecting pipes			
	Liquid pipe	in. (mm)	ϕ 1/2 (12.7) C1220T (brazing connection)	ϕ 1/2 (12.7) C1220T (brazing connection)
	Suction gas pipe	in. (mm)	ϕ 1-1/8 (28.6) C1220T (brazing connection)	ϕ 1-1/8 (28.6) C1220T (brazing connection)
	High/Low pressure gas pipe	in. (mm)	ϕ 3/4 (19.1) C1220T (brazing connection)	ϕ 7/8 (22.2) C1220T (brazing connection)
Weight		lbs (kg)	728 (330)	800 (363)
Sound pressure level (Reference data)		dB(A)	61	65
Sound power level (Reference data)		dB	82	84
Safety devices			High pressure switch, Fan driver overload protector, Overcurrent fuse, Inverter overload protector, Leak detecting device	High pressure switch, Fan driver overload protector, Overcurrent fuse, Inverter overload protector, Leak detecting device
Defrost method			Deicer	Deicer
Capacity control		%	3-100	3-100
Refrigerant	Refrigerant name		R-410A	R-410A
	Charge	lbs (kg)	25.8 (11.7)	25.8 (11.7)
	Control		Electronic expansion valve	Electronic expansion valve
Standard accessories			Installation manual, Operation manual, Connection pipes, Clamps	Installation manual, Operation manual, Connection pipes, Clamps
Drawing No.			4D134608A	4D134609A

**Notes:**

- ★1. Indoor temp.: 80°FDB (26.7°CDB), 67°FWB (19.4°CWB) / Outdoor temp.: 95°FDB (35.0°CDB) / Rated capacity is certified under AHRI standard 1230.  
★2. Indoor temp.: 70°FDB (21.1°CDB) / Outdoor temp.: 47°FDB (8.3°CDB), 43°FWB (6.1°CWB) / Rated capacity is certified under AHRI standard 1230.

Model name			REYQ168AAAYDA	REYQ192AAAYDA
Power supply			3 phase, 460 V, 60 Hz	3 phase, 460 V, 60 Hz
★1 Cooling capacity	Nominal	Btu/h (kW)	168,000 (49.2)	192,000 (56.3)
	Rated		160,000 (46.9)	184,000 (53.9)
★2 Heating capacity	Nominal	Btu/h (kW)	189,000 (55.4)	216,000 (63.3)
	Rated		180,000 (52.8)	206,000 (60.4)
Casing color			Ivory white (5Y7.5/1)	Ivory white (5Y7.5/1)
Dimensions: (H × W × D)		in. (mm)	65-3/8 × 48-13/16 × 30-1/8 (1,660 × 1,240 × 765)	65-3/8 × 68-7/8 × 30-1/8 (1,660 × 1,750 × 765)
Heat exchanger			Cross fin coil	Cross fin coil
Compressor	Type		Hermetically sealed scroll type	Hermetically sealed scroll type
	Volume	m <sup>3</sup> /h	14.2 + 22.7	18.9 + 18.9
	Number of revolutions	r/min	6,684 + 6,684	5,586 + 5,586
	Motor output	kW	4.09 + 6.96	5.82 + 5.82
	Starting method		Soft start	Soft start
Fan	Type		Propeller fan	Propeller fan
	Motor output × Number of units	kW	0.65 × 2	0.95 × 2
	Airflow rate	cfm (m <sup>3</sup> /min)	9,675 (274)	13,650 (386.5)
	Drive		Direct drive	Direct drive
	Connecting pipes			
	Liquid pipe	in. (mm)	ϕ 5/8 (15.9) C1220T (brazing connection)	ϕ 5/8 (15.9) C1220T (brazing connection)
	Suction gas pipe	in. (mm)	ϕ 1-1/8 (28.6) C1220T (brazing connection)	ϕ 1-1/8 (28.6) C1220T (brazing connection)
	High/Low pressure gas pipe	in. (mm)	ϕ 7/8 (22.2) C1220T (brazing connection)	ϕ 1-1/8 (28.6) C1220T (brazing connection)
Weight		lbs (kg)	802 (364)	972 (441)
Sound pressure level (Reference data)		dB(A)	65	67
Sound power level (Reference data)		dB	85	87
Safety devices			High pressure switch, Fan driver overload protector, Overcurrent fuse, Inverter overload protector, Leak detecting device	High pressure switch, Fan driver overload protector, Overcurrent fuse, Inverter overload protector, Leak detecting device
Defrost method			Deicer	Deicer
Capacity control		%	2-100	4-100
Refrigerant	Refrigerant name		R-410A	R-410A
	Charge	lbs (kg)	25.8 (11.7)	25.8 (11.7)
	Control		Electronic expansion valve	Electronic expansion valve
Standard accessories			Installation manual, Operation manual, Connection pipes, Clamps	Installation manual, Operation manual, Connection pipes, Clamps
Drawing No.			4D134609A	4D134609A

**Notes:**

- ★1. Indoor temp.: 80°FDB (26.7°CDB), 67°FWB (19.4°CWB) / Outdoor temp.: 95°FDB (35.0°CDB) / Rated capacity is certified under AHRI standard 1230.
- ★2. Indoor temp.: 70°FDB (21.1°CDB) / Outdoor temp.: 47°FDB (8.3°CDB), 43°FWB (6.1°CWB) / Rated capacity is certified under AHRI standard 1230.

Model name			REYQ216AAYDA	REYQ240AAYDA
Power supply			3 phase, 460 V, 60 Hz	3 phase, 460 V, 60 Hz
★1 Cooling capacity	Nominal	Btu/h (kW)	216,000 (63.3)	240,000 (70.3)
	Rated		206,000 (60.4)	228,000 (66.8)
★2 Heating capacity	Nominal	Btu/h (kW)	243,000 (71.2)	270,000 (79.1)
	Rated		232,000 (68.0)	256,000 (75.0)
Casing color			Ivory white (5Y7.5/1)	Ivory white (5Y7.5/1)
Dimensions: (H × W × D)		in. (mm)	65-3/8 × 68-7/8 × 30-1/8 (1,660 × 1,750 × 765)	65-3/8 × 68-7/8 × 30-1/8 (1,660 × 1,750 × 765)
Heat exchanger			Cross fin coil	Cross fin coil
Compressor	Type		Hermetically sealed scroll type	Hermetically sealed scroll type
	Volume	m <sup>3</sup> /h	21.3 + 21.3	24.7 + 24.7
	Number of revolutions	r/min	6,294 + 6,294	7,272 + 7,272
	Motor output	kW	6.56 + 6.56	7.58 + 7.58
	Starting method		Soft start	Soft start
Fan	Type		Propeller fan	Propeller fan
	Motor output × Number of units	kW	0.95 × 2	0.95 × 2
	Airflow rate	cfm (m <sup>3</sup> /min)	14,505 (410.8)	14,505 (410.8)
	Drive		Direct drive	Direct drive
	Connecting pipes			
	Liquid pipe	in. (mm)	ϕ 5/8 (15.9) C1220T (brazing connection)	ϕ 5/8 (15.9) C1220T (brazing connection)
	Suction gas pipe	in. (mm)	ϕ 1-1/8 (28.6) C1220T (brazing connection)	ϕ 1-3/8 (34.9) C1220T (brazing connection)
	High/Low pressure gas pipe	in. (mm)	ϕ 1-1/8 (28.6) C1220T (brazing connection)	ϕ 1-1/8 (28.6) C1220T (brazing connection)
Weight		lbs (kg)	972 (441)	972 (441)
Sound pressure level (Reference data)		dB(A)	68	69
Sound power level (Reference data)		dB	90	90
Safety devices			High pressure switch, Fan driver overload protector, Overcurrent fuse, Inverter overload protector, Leak detecting device	High pressure switch, Fan driver overload protector, Overcurrent fuse, Inverter overload protector, Leak detecting device
Defrost method			Deicer	Deicer
Capacity control		%	3-100	3-100
Refrigerant	Refrigerant name		R-410A	R-410A
	Charge	lbs (kg)	25.8 (11.7)	25.8 (11.7)
	Control		Electronic expansion valve	Electronic expansion valve
Standard accessories			Installation manual, Operation manual, Connection pipes, Clamps	Installation manual, Operation manual, Connection pipes, Clamps
Drawing No.			4D134610A	4D134610A

**Notes:**

- ★1. Indoor temp.: 80°FDB (26.7°CDB), 67°FWB (19.4°CWB) / Outdoor temp.: 95°FDB (35.0°CDB) / Rated capacity is certified under AHRI standard 1230.  
★2. Indoor temp.: 70°FDB (21.1°CDB) / Outdoor temp.: 47°FDB (8.3°CDB), 43°FWB (6.1°CWB) / Rated capacity is certified under AHRI standard 1230.

Model name (Combination unit)		REYQ264AAAYDA		REYQ288AAAYDA		
Model name (Independent unit)		REYQ120AAAYDA REYQ144AAAYDA		REYQ144AAAYDA REYQ144AAAYDA		
Power supply		3 phase, 460 V, 60 Hz		3 phase, 460 V, 60 Hz		
★1 Cooling capacity	Nominal	Btu/h (kW)	264,000 (77.4)	288,000 (84.4)		
	Rated		252,000 (73.9)	274,000 (80.3)		
★2 Heating capacity	Nominal	Btu/h (kW)	297,000 (87.0)	324,000 (95.0)		
	Rated		282,000 (82.6)	294,000 (86.2)		
Casing color		Ivory white (5Y7.5/1)		Ivory white (5Y7.5/1)		
Dimensions: (H × W × D)		in. (mm)	65-3/8 × 48-13/16 × 30-1/8 + 65-3/8 × 48-13/16 × 30-1/8 (1,660 × 1,240 × 765 + 1,660 × 1,240 × 765)	65-3/8 × 48-13/16 × 30-1/8 + 65-3/8 × 48-13/16 × 30-1/8 (1,660 × 1,240 × 765 + 1,660 × 1,240 × 765)		
Heat exchanger		Cross fin coil		Cross fin coil		
Compressor	Type	Hermetically sealed scroll type		Hermetically sealed scroll type		
	Volume	m <sup>3</sup> /h	(12.5 + 12.5) + (11.3 + 18.1)	(10.8 + 17.3) + (10.8 + 17.3)		
	Number of revolutions	r/min	(5,892 + 5,892) + (5,334 + 5,334)	(5,094 + 5,094) + (5,094 + 5,094)		
	Motor output	kW	(3.6 + 3.6) + (3.26 + 5.55)	(3.11 + 5.31) + (3.11 + 5.31)		
	Starting method	Soft start		Soft start		
Fan	Type	Propeller fan		Propeller fan		
	Motor output × Number of units	kW	0.65 × 2 + 0.65 × 2	0.65 × 2 + 0.65 × 2		
	Airflow rate	cfm (m <sup>3</sup> /min)	8,965 (253.9) + 9,675 (274)	9,675 (274) + 9,675 (274)		
	Drive	Direct drive		Direct drive		
Connecting pipes	Liquid pipe	in. (mm)	φ 3/4 (19.1) C1220T (brazing connection)	φ 3/4 (19.1) C1220T (brazing connection)		
	Suction gas pipe	in. (mm)	φ 1-3/8 (34.9) C1220T (brazing connection)	φ 1-3/8 (34.9) C1220T (brazing connection)		
	High/Low pressure gas pipe	in. (mm)	φ 1-1/8 (28.6) C1220T (brazing connection)	φ 1-1/8 (28.6) C1220T (brazing connection)		
Weight	lbs (kg)	728 (330) + 800 (363)		800 (363) + 800 (363)		
Sound pressure level (Reference data)	dB(A)	67		69		
Sound power level (Reference data)	dB	88		88		
Safety devices		High pressure switch, Fan driver overload protector, Overcurrent fuse, Inverter overload protector, Leak detecting device		High pressure switch, Fan driver overload protector, Overcurrent fuse, Inverter overload protector, Leak detecting device		
Defrost method		Deicer		Deicer		
Capacity control		%	1-100		1-100	
Refrigerant	Refrigerant name		R-410A		R-410A	
	Charge	lbs (kg)	25.8 (11.7) + 25.8 (11.7)		25.8 (11.7) + 25.8 (11.7)	
	Control		Electronic expansion valve		Electronic expansion valve	
Standard accessories		Installation manual, Operation manual, Connection pipes, Clamps		Installation manual, Operation manual, Connection pipes, Clamps		
Drawing No.		4D134611A		4D134611A		

**Notes:**

- ★1. Indoor temp.: 80°FDB (26.7°CDB), 67°FWB (19.4°CWB) / Outdoor temp.: 95°FDB (35.0°CDB) / Rated capacity is certified under AHRI standard 1230.
- ★2. Indoor temp.: 70°FDB (21.1°CDB) / Outdoor temp.: 47°FDB (8.3°CDB), 43°FWB (6.1°CWB) / Rated capacity is certified under AHRI standard 1230.

Model name (Combination unit)			REYQ312AAAYDA	REYQ336AAAYDA
Model name (Independent unit)			REYQ144AAAYDA REYQ168AAAYDA	REYQ168AAAYDA REYQ168AAAYDA
Power supply			3 phase, 460 V, 60 Hz	3 phase, 460 V, 60 Hz
★1 Cooling capacity	Nominal	Btu/h (kW)	312,000 (91.4)	336,000 (98.5)
	Rated		296,000 (86.7)	320,000 (93.8)
★2 Heating capacity	Nominal	Btu/h (kW)	351,000 (103)	378,000 (111)
	Rated		320,000 (93.8)	338,000 (99.1)
Casing color			Ivory white (5Y7.5/1)	Ivory white (5Y7.5/1)
Dimensions: (H × W × D)		in. (mm)	65-3/8 × 48-13/16 × 30-1/8 + 65-3/8 × 48-13/16 × 30-1/8 (1,660 × 1,240 × 765 + 1,660 × 1,240 × 765)	65-3/8 × 48-13/16 × 30-1/8 + 65-3/8 × 48-13/16 × 30-1/8 (1,660 × 1,240 × 765 + 1,660 × 1,240 × 765)
Heat exchanger			Cross fin coil	Cross fin coil
Compressor	Type		Hermetically sealed scroll type	Hermetically sealed scroll type
	Volume	m <sup>3</sup> /h	(11 + 17.6) + (13.1 + 20.9)	(12.9 + 20.6) + (12.9 + 20.6)
	Number of revolutions	r/min	(5,184 + 5,184) + (6,174 + 6,174)	(6,078 + 6,078) + (6,078 + 6,078)
	Motor output	kW	(3.17 + 5.4) + (3.77 + 6.43)	(3.71 + 6.33) + (3.71 + 6.33)
	Starting method		Soft start	Soft start
Fan	Type		Propeller fan	Propeller fan
	Motor output × Number of units	kW	0.65 × 2 + 0.65 × 2	0.65 × 2 + 0.65 × 2
	Airflow rate	cfm (m <sup>3</sup> /min)	9,675 (274) + 9,675 (274)	9,675 (274) + 9,675 (274)
	Drive		Direct drive	Direct drive
Connecting pipes	Liquid pipe	in. (mm)	φ 3/4 (19.1) C1220T (brazing connection)	φ 3/4 (19.1) C1220T (brazing connection)
	Suction gas pipe	in. (mm)	φ 1-3/8 (34.9) C1220T (brazing connection)	φ 1-3/8 (34.9) C1220T (brazing connection)
	High/Low pressure gas pipe	in. (mm)	φ 1-1/8 (28.6) C1220T (brazing connection)	φ 1-1/8 (28.6) C1220T (brazing connection)
Weight		lbs (kg)	800 (363) + 802 (364)	802 (364) + 802 (364)
Sound pressure level (Reference data)		dB(A)	69	69
Sound power level (Reference data)		dB	89	88
Safety devices			High pressure switch, Fan driver overload protector, Overcurrent fuse, Inverter overload protector, Leak detecting device	High pressure switch, Fan driver overload protector, Overcurrent fuse, Inverter overload protector, Leak detecting device
Defrost method			Deicer	Deicer
Capacity control		%	1-100	1-100
Refrigerant	Refrigerant name		R-410A	R-410A
	Charge	lbs (kg)	25.8 (11.7) + 25.8 (11.7)	25.8 (11.7) + 25.8 (11.7)
	Control		Electronic expansion valve	Electronic expansion valve
Standard accessories			Installation manual, Operation manual, Connection pipes, Clamps	Installation manual, Operation manual, Connection pipes, Clamps
Drawing No.			4D134611A	4D134612A

**Notes:**

- ★1. Indoor temp.: 80°FDB (26.7°CDB), 67°FWB (19.4°CWB) / Outdoor temp.: 95°FDB (35.0°CDB) / Rated capacity is certified under AHRI standard 1230.  
★2. Indoor temp.: 70°FDB (21.1°CDB) / Outdoor temp.: 47°FDB (8.3°CDB), 43°FWB (6.1°CWB) / Rated capacity is certified under AHRI standard 1230.

Model name (Combination unit)		REYQ360AAAYDA		REYQ384AAAYDA		
Model name (Independent unit)		REYQ168AAAYDA REYQ192AAAYDA		REYQ192AAAYDA REYQ192AAAYDA		
Power supply		3 phase, 460 V, 60 Hz		3 phase, 460 V, 60 Hz		
★1 Cooling capacity	Nominal	Btu/h (kW)	360,000 (106)	384,000 (113)		
	Rated		342,000 (100)	364,000 (107)		
★2 Heating capacity	Nominal	Btu/h (kW)	405,000 (119)	432,000 (127)		
	Rated		376,000 (110)	386,000 (113)		
Casing color		Ivory white (5Y7.5/1)		Ivory white (5Y7.5/1)		
Dimensions: (H × W × D)		in. (mm)	65-3/8 × 48-13/16 × 30-1/8 + 65-3/8 × 68-7/8 × 30-1/8 (1,660 × 1,240 × 765 + 1,660 × 1,750 × 765)	65-3/8 × 68-7/8 × 30-1/8 + 65-3/8 × 68-7/8 × 30-1/8 (1,660 × 1,750 × 765 + 1,660 × 1,750 × 765)		
Heat exchanger		Cross fin coil		Cross fin coil		
Compressor	Type	Hermetically sealed scroll type		Hermetically sealed scroll type		
	Volume	m <sup>3</sup> /h	(13.2 + 21.1) + (18 + 18)	(17.2 + 17.2) + (17.2 + 17.2)		
	Number of revolutions	r/min	(6,228 + 6,228) + (5,310 + 5,310)	(5,064 + 5,064) + (5,064 + 5,064)		
	Motor output	kW	(3.81 + 6.49) + (5.53 + 5.53)	(5.27 + 5.27) + (5.27 + 5.27)		
	Starting method	Soft start		Soft start		
Fan	Type	Propeller fan		Propeller fan		
	Motor output × Number of units	kW	0.65 × 2 + 0.95 × 2	0.95 × 2 + 0.95 × 2		
	Airflow rate	cfm (m <sup>3</sup> /min)	9,675 (274) + 13,650 (386.5)	13,650 (386.5) + 13,650 (386.5)		
	Drive	Direct drive		Direct drive		
Connecting pipes	Liquid pipe	in. (mm)	φ 3/4 (19.1) C1220T (brazing connection)	φ 3/4 (19.1) C1220T (brazing connection)		
	Suction gas pipe	in. (mm)	φ 1-5/8 (41.3) C1220T (brazing connection)	φ 1-5/8 (41.3) C1220T (brazing connection)		
	High/Low pressure gas pipe	in. (mm)	φ 1-3/8 (34.9) C1220T (brazing connection)	φ 1-3/8 (34.9) C1220T (brazing connection)		
Weight	lbs (kg)	802 (364) + 972 (441)		972 (441) + 972 (441)		
Sound pressure level (Reference data)	dB(A)	70		71		
Sound power level (Reference data)	dB	91		92		
Safety devices		High pressure switch, Fan driver overload protector, Overcurrent fuse, Inverter overload protector, Leak detecting device		High pressure switch, Fan driver overload protector, Overcurrent fuse, Inverter overload protector, Leak detecting device		
Defrost method		Deicer		Deicer		
Capacity control		%	1-100		1-100	
Refrigerant	Refrigerant name	R-410A		R-410A		
	Charge	lbs (kg)	25.8 (11.7) + 25.8 (11.7)		25.8 (11.7) + 25.8 (11.7)	
	Control	Electronic expansion valve		Electronic expansion valve		
Standard accessories		Installation manual, Operation manual, Connection pipes, Clamps		Installation manual, Operation manual, Connection pipes, Clamps		
Drawing No.		4D134612A		4D134612A		

**Notes:**

- ★1. Indoor temp.: 80°FDB (26.7°CDB), 67°FWB (19.4°CWB) / Outdoor temp.: 95°FDB (35.0°CDB) / Rated capacity is certified under AHRI standard 1230.
- ★2. Indoor temp.: 70°FDB (21.1°CDB) / Outdoor temp.: 47°FDB (8.3°CDB), 43°FWB (6.1°CWB) / Rated capacity is certified under AHRI standard 1230.



Model name (Combination unit)		REYQ408AAAYDA		REYQ432AAAYDA	
Model name (Independent unit)		REYQ192AAAYDA REYQ216AAAYDA		REYQ216AAAYDA REYQ216AAAYDA	
Power supply		3 phase, 460 V, 60 Hz		3 phase, 460 V, 60 Hz	
★1 Cooling capacity	Nominal	Btu/h	408,000 (120)	Btu/h	432,000 (127)
	Rated	(kW)	388,000 (114)	(kW)	410,000 (120)
★2 Heating capacity	Nominal	Btu/h	459,000 (135)	Btu/h	486,000 (142)
	Rated	(kW)	394,000 (115)	(kW)	404,000 (118)
Casing color		Ivory white (5Y7.5/1)		Ivory white (5Y7.5/1)	
Dimensions: (H × W × D)		in. (mm)	65-3/8 × 68-7/8 × 30-1/8 + 65-3/8 × 68-7/8 × 30-1/8 (1,660 × 1,750 × 765 + 1,660 × 1,750 × 765)	in. (mm)	65-3/8 × 68-7/8 × 30-1/8 + 65-3/8 × 68-7/8 × 30-1/8 (1,660 × 1,750 × 765 + 1,660 × 1,750 × 765)
Heat exchanger		Cross fin coil		Cross fin coil	
Compressor	Type	Hermetically sealed scroll type		Hermetically sealed scroll type	
	Volume	m <sup>3</sup> /h	(16.3 + 16.3) + (18.5 + 18.5)	m <sup>3</sup> /h	(17.7 + 17.7) + (17.7 + 17.7)
	Number of revolutions	r/min	(4,818 + 4,818) + (5,442 + 5,442)	r/min	(5,232 + 5,232) + (5,232 + 5,232)
	Motor output	kW	(5.02 + 5.02) + (5.67 + 5.67)	kW	(5.45 + 5.45) + (5.45 + 5.45)
	Starting method	Soft start		Soft start	
Fan	Type	Propeller fan		Propeller fan	
	Motor output × Number of units	kW	0.95 × 2 + 0.95 × 2	kW	0.95 × 2 + 0.95 × 2
	Airflow rate	cfm (m <sup>3</sup> /min)	13,650 (386.5) + 14,505 (410.8)	cfm (m <sup>3</sup> /min)	14,505 (410.8) + 14,505 (410.8)
	Drive	Direct drive		Direct drive	
Connecting pipes	Liquid pipe	in. (mm)	φ 3/4 (19.1) C1220T (brazing connection)	in. (mm)	φ 3/4 (19.1) C1220T (brazing connection)
	Suction gas pipe	in. (mm)	φ 1-5/8 (41.3) C1220T (brazing connection)	in. (mm)	φ 1-5/8 (41.3) C1220T (brazing connection)
	High/Low pressure gas pipe	in. (mm)	φ 1-3/8 (34.9) C1220T (brazing connection)	in. (mm)	φ 1-3/8 (34.9) C1220T (brazing connection)
Weight	lbs (kg)	972 (441) + 972 (441)	lbs (kg)	972 (441) + 972 (441)	
Sound pressure level (Reference data)	dB(A)	71	dB(A)	72	
Sound power level (Reference data)	dB	93	dB	95	
Safety devices	High pressure switch, Fan driver overload protector, Overcurrent fuse, Inverter overload protector, Leak detecting device		High pressure switch, Fan driver overload protector, Overcurrent fuse, Inverter overload protector, Leak detecting device		
Defrost method	Deicer		Deicer		
Capacity control	%	1-100	%	1-100	
Refrigerant	Refrigerant name	R-410A		R-410A	
	Charge	lbs (kg)	25.8 (11.7) + 25.8 (11.7)	lbs (kg)	25.8 (11.7) + 25.8 (11.7)
	Control	Electronic expansion valve		Electronic expansion valve	
Standard accessories	Installation manual, Operation manual, Connection pipes, Clamps		Installation manual, Operation manual, Connection pipes, Clamps		
Drawing No.	4D134613A		4D134613A		

**Notes:**

- ★1. Indoor temp.: 80°FDB (26.7°CDB), 67°FWB (19.4°CWB) / Outdoor temp.: 95°FDB (35.0°CDB) / Rated capacity is certified under AHRI standard 1230.  
★2. Indoor temp.: 70°FDB (21.1°CDB) / Outdoor temp.: 47°FDB (8.3°CDB), 43°FWB (6.1°CWB) / Rated capacity is certified under AHRI standard 1230.

Model name (Combination unit)		REYQ456AAAYDA		REYQ480AAAYDA	
Model name (Independent unit)		REYQ216AAAYDA REYQ240AAAYDA		REYQ240AAAYDA REYQ240AAAYDA	
Power supply		3 phase, 460 V, 60 Hz		3 phase, 460 V, 60 Hz	
★1 Cooling capacity	Nominal	Btu/h	456,000 (134)	Btu/h	480,000 (141)
	Rated	(kW)	434,000 (127)	(kW)	456,000 (134)
★2 Heating capacity	Nominal	Btu/h	513,000 (150)	Btu/h	540,000 (158)
	Rated	(kW)	414,000 (121)	(kW)	424,000 (124)
Casing color		Ivory white (5Y7.5/1)		Ivory white (5Y7.5/1)	
Dimensions: (H × W × D)		in. (mm)	65-3/8 × 68-7/8 × 30-1/8 + 65-3/8 × 68-7/8 × 30-1/8 (1,660 × 1,750 × 765 + 1,660 × 1,750 × 765)	in. (mm)	65-3/8 × 68-7/8 × 30-1/8 + 65-3/8 × 68-7/8 × 30-1/8 (1,660 × 1,750 × 765 + 1,660 × 1,750 × 765)
Heat exchanger		Cross fin coil		Cross fin coil	
Compressor	Type	Hermetically sealed scroll type		Hermetically sealed scroll type	
	Volume	m <sup>3</sup> /h	(17.5 + 17.5) + (20 + 20)	m <sup>3</sup> /h	(20.4 + 20.4) + (20.4 + 20.4)
	Number of revolutions	r/min	(5,154 + 5,154) + (5,886 + 5,886)	r/min	(6,018 + 6,018) + (6,018 + 6,018)
	Motor output	kW	(5.37 + 5.37) + (6.13 + 6.13)	kW	(6.27 + 6.27) + (6.27 + 6.27)
	Starting method	Soft start		Soft start	
Fan	Type	Propeller fan		Propeller fan	
	Motor output × Number of units	kW	0.95 × 2 + 0.95 × 2	kW	0.95 × 2 + 0.95 × 2
	Airflow rate	cfm (m <sup>3</sup> /min)	14,505 (410.8) + 14,505 (410.8)	cfm (m <sup>3</sup> /min)	14,505 (410.8) + 14,505 (410.8)
	Drive	Direct drive		Direct drive	
Connecting pipes	Liquid pipe	in. (mm)	φ 3/4 (19.1) C1220T (brazing connection)	in. (mm)	φ 3/4 (19.1) C1220T (brazing connection)
	Suction gas pipe	in. (mm)	φ 1-5/8 (41.3) C1220T (brazing connection)	in. (mm)	φ 1-5/8 (41.3) C1220T (brazing connection)
	High/Low pressure gas pipe	in. (mm)	φ 1-3/8 (34.9) C1220T (brazing connection)	in. (mm)	φ 1-3/8 (34.9) C1220T (brazing connection)
Weight	lbs (kg)	972 (441) + 972 (441)	lbs (kg)	972 (441) + 972 (441)	
Sound pressure level (Reference data)	dB(A)	72	dB(A)	73	
Sound power level (Reference data)	dB	95	dB	95	
Safety devices	High pressure switch, Fan driver overload protector, Overcurrent fuse, Inverter overload protector, Leak detecting device		High pressure switch, Fan driver overload protector, Overcurrent fuse, Inverter overload protector, Leak detecting device		
Defrost method	Deicer		Deicer		
Capacity control	%	1-100	%	1-100	
Refrigerant	Refrigerant name	R-410A		Refrigerant name	R-410A
	Charge	lbs (kg)	25.8 (11.7) + 25.8 (11.7)	lbs (kg)	25.8 (11.7) + 25.8 (11.7)
	Control	Electronic expansion valve		Electronic expansion valve	
Standard accessories	Installation manual, Operation manual, Connection pipes, Clamps		Installation manual, Operation manual, Connection pipes, Clamps		
Drawing No.	4D134613A		4D134614A		

**Notes:**

- ★1. Indoor temp.: 80°FDB (26.7°CDB), 67°FWB (19.4°CWB) / Outdoor temp.: 95°FDB (35.0°CDB) / Rated capacity is certified under AHRI standard 1230.
- ★2. Indoor temp.: 70°FDB (21.1°CDB) / Outdoor temp.: 47°FDB (8.3°CDB), 43°FWB (6.1°CWB) / Rated capacity is certified under AHRI standard 1230.

Model name			REYQ72AAAYDB	REYQ96AAAYDB
Power supply			3 phase, 460 V, 60 Hz	3 phase, 460 V, 60 Hz
★1 Cooling capacity	Nominal	Btu/h (kW)	72,000 (21.1)	96,000 (28.1)
	Rated		69,000 (20.2)	92,000 (27.0)
★2 Heating capacity	Nominal	Btu/h (kW)	81,000 (23.7)	108,000 (31.7)
	Rated		69,000 (20.2)	92,000 (27.0)
Casing color			Ivory white (5Y7.5/1)	Ivory white (5Y7.5/1)
Dimensions: (H × W × D)		in. (mm)	65-3/8 × 36-5/8 × 30-1/8 (1,660 × 930 × 765)	65-3/8 × 48-13/16 × 30-1/8 (1,660 × 1,240 × 765)
Heat exchanger			Cross fin coil	Cross fin coil
Compressor	Type		Hermetically sealed scroll type	Hermetically sealed scroll type
	Volume	m <sup>3</sup> /h	14.3	9.5 + 9.5
	Number of revolutions	r/min	4,212	4,482 + 4,482
	Motor output	kW	4.39	2.74 + 2.74
	Starting method		Soft start	Soft start
Fan	Type		Propeller fan	Propeller fan
	Motor output × Number of units	kW	0.95 × 1	0.65 × 2
	Airflow rate	cfm (m <sup>3</sup> /min)	6,200 (175.6)	8,965 (253.9)
	Drive		Direct drive	Direct drive
	Connecting pipes			
	Liquid pipe	in. (mm)	φ 3/8 (9.5) C1220T (brazing connection)	φ 3/8 (9.5) C1220T (brazing connection)
	Suction gas pipe	in. (mm)	φ 3/4 (19.1) C1220T (brazing connection)	φ 7/8 (22.2) C1220T (brazing connection)
	High/Low pressure gas pipe	in. (mm)	φ 5/8 (15.9) C1220T (brazing connection)	φ 3/4 (19.1) C1220T (brazing connection)
Weight		lbs (kg)	525 (238)	725 (329)
Sound pressure level (Reference data)		dB(A)	58	61
Sound power level (Reference data)		dB	80	82
Safety devices			High pressure switch, Fan driver overload protector, Overcurrent fuse, Inverter overload protector, Leak detecting device	High pressure switch, Fan driver overload protector, Overcurrent fuse, Inverter overload protector, Leak detecting device
Defrost method			Deicer	Deicer
Capacity control		%	7-100	4-100
Refrigerant	Refrigerant name		R-410A	R-410A
	Charge	lbs (kg)	23.4 (10.6)	25.8 (11.7)
	Control		Electronic expansion valve	Electronic expansion valve
Standard accessories			Installation manual, Operation manual, Connection pipes, Clamps	Installation manual, Operation manual, Connection pipes, Clamps
Drawing No.			4D148474	4D148474

**Notes:**

- ★1. Indoor temp.: 80°FDB (26.7°CDB), 67°FWB (19.4°CWB) / Outdoor temp.: 95°FDB (35.0°CDB) / Rated capacity is certified under AHRI standard 1230.  
★2. Indoor temp.: 70°FDB (21.1°CDB) / Outdoor temp.: 47°FDB (8.3°CDB), 43°FWB (6.1°CWB) / Rated capacity is certified under AHRI standard 1230.

Model name			REYQ120AAAYDB	REYQ144AAAYDB
Power supply			3 phase, 460 V, 60 Hz	3 phase, 460 V, 60 Hz
★1 Cooling capacity	Nominal	Btu/h (kW)	119,000 (34.9)	144,000 (42.2)
	Rated		114,000 (33.4)	138,000 (40.4)
★2 Heating capacity	Nominal	Btu/h (kW)	135,000 (39.6)	162,000 (47.5)
	Rated		114,000 (33.4)	138,000 (40.4)
Casing color			Ivory white (5Y7.5/1)	Ivory white (5Y7.5/1)
Dimensions: (H × W × D)		in. (mm)	65-3/8 × 48-13/16 × 30-1/8 (1,660 × 1,240 × 765)	65-3/8 × 48-13/16 × 30-1/8 (1,660 × 1,240 × 765)
Heat exchanger			Cross fin coil	Cross fin coil
Compressor	Type		Hermetically sealed scroll type	Hermetically sealed scroll type
	Volume	m <sup>3</sup> /h	12.6 + 12.6	11.6 + 18.6
	Number of revolutions	r/min	5,934 + 5,934	5,496 + 5,496
	Motor output	kW	3.63 + 3.63	3.36 + 5.72
	Starting method		Soft start	Soft start
Fan	Type		Propeller fan	Propeller fan
	Motor output × Number of units	kW	0.65 × 2	0.65 × 2
	Airflow rate	cfm (m <sup>3</sup> /min)	8,965 (253.9)	9,675 (274)
	Drive		Direct drive	Direct drive
	Connecting pipes			
	Liquid pipe	in. (mm)	φ 1/2 (12.7) C1220T (brazing connection)	φ 1/2 (12.7) C1220T (brazing connection)
	Suction gas pipe	in. (mm)	φ 1-1/8 (28.6) C1220T (brazing connection)	φ 1-1/8 (28.6) C1220T (brazing connection)
	High/Low pressure gas pipe	in. (mm)	φ 3/4 (19.1) C1220T (brazing connection)	φ 7/8 (22.2) C1220T (brazing connection)
Weight		lbs (kg)	728 (330)	800 (363)
Sound pressure level (Reference data)		dB(A)	61	65
Sound power level (Reference data)		dB	82	84
Safety devices			High pressure switch, Fan driver overload protector, Overcurrent fuse, Inverter overload protector, Leak detecting device	High pressure switch, Fan driver overload protector, Overcurrent fuse, Inverter overload protector, Leak detecting device
Defrost method			Deicer	Deicer
Capacity control		%	3-100	3-100
Refrigerant	Refrigerant name		R-410A	R-410A
	Charge	lbs (kg)	25.8 (11.7)	25.8 (11.7)
	Control		Electronic expansion valve	Electronic expansion valve
Standard accessories			Installation manual, Operation manual, Connection pipes, Clamps	Installation manual, Operation manual, Connection pipes, Clamps
Drawing No.			4D148474	4D148475

**Notes:**

- ★1. Indoor temp.: 80°FDB (26.7°CDB), 67°FWB (19.4°CWB) / Outdoor temp.: 95°FDB (35.0°CDB) / Rated capacity is certified under AHRI standard 1230.
- ★2. Indoor temp.: 70°FDB (21.1°CDB) / Outdoor temp.: 47°FDB (8.3°CDB), 43°FWB (6.1°CWB) / Rated capacity is certified under AHRI standard 1230.

Model name			REYQ168AAAYDB	REYQ192AAAYDB
Power supply			3 phase, 460 V, 60 Hz	3 phase, 460 V, 60 Hz
★1 Cooling capacity	Nominal	Btu/h (kW)	162,000 (47.5)	192,000 (56.3)
	Rated		156,000 (45.7)	184,000 (53.9)
★2 Heating capacity	Nominal	Btu/h (kW)	189,000 (55.4)	216,000 (63.3)
	Rated		156,000 (45.7)	184,000 (53.9)
Casing color			Ivory white (5Y7.5/1)	Ivory white (5Y7.5/1)
Dimensions: (H × W × D)		in. (mm)	65-3/8 × 48-13/16 × 30-1/8 (1,660 × 1,240 × 765)	65-3/8 × 68-7/8 × 30-1/8 (1,660 × 1,750 × 765)
Heat exchanger			Cross fin coil	Cross fin coil
Compressor	Type		Hermetically sealed scroll type	Hermetically sealed scroll type
	Volume	m <sup>3</sup> /h	14.2 + 22.7	18.9 + 18.9
	Number of revolutions	r/min	6,684 + 6,684	5,586 + 5,586
	Motor output	kW	4.09 + 6.96	5.82 + 5.82
	Starting method		Soft start	Soft start
Fan	Type		Propeller fan	Propeller fan
	Motor output × Number of units	kW	0.65 × 2	0.95 × 2
	Airflow rate	cfm (m <sup>3</sup> /min)	9,675 (274)	13,650 (386.5)
	Drive		Direct drive	Direct drive
	Connecting pipes			
	Liquid pipe	in. (mm)	φ 5/8 (15.9) C1220T (brazing connection)	φ 5/8 (15.9) C1220T (brazing connection)
	Suction gas pipe	in. (mm)	φ 1-1/8 (28.6) C1220T (brazing connection)	φ 1-1/8 (28.6) C1220T (brazing connection)
	High/Low pressure gas pipe	in. (mm)	φ 7/8 (22.2) C1220T (brazing connection)	φ 1-1/8 (28.6) C1220T (brazing connection)
Weight		lbs (kg)	802 (364)	972 (441)
Sound pressure level (Reference data)		dB(A)	65	67
Sound power level (Reference data)		dB	85	87
Safety devices			High pressure switch, Fan driver overload protector, Overcurrent fuse, Inverter overload protector, Leak detecting device	High pressure switch, Fan driver overload protector, Overcurrent fuse, Inverter overload protector, Leak detecting device
Defrost method			Deicer	Deicer
Capacity control		%	2-100	4-100
Refrigerant	Refrigerant name		R-410A	R-410A
	Charge	lbs (kg)	25.8 (11.7)	25.8 (11.7)
	Control		Electronic expansion valve	Electronic expansion valve
Standard accessories			Installation manual, Operation manual, Connection pipes, Clamps	Installation manual, Operation manual, Connection pipes, Clamps
Drawing No.			4D148475	4D148475

**Notes:**

- ★1. Indoor temp.: 80°FDB (26.7°CDB), 67°FWB (19.4°CWB) / Outdoor temp.: 95°FDB (35.0°CDB) / Rated capacity is certified under AHRI standard 1230.  
★2. Indoor temp.: 70°FDB (21.1°CDB) / Outdoor temp.: 47°FDB (8.3°CDB), 43°FWB (6.1°CWB) / Rated capacity is certified under AHRI standard 1230.

Model name			REYQ216AAAYDB	REYQ240AAAYDB
Power supply			3 phase, 460 V, 60 Hz	3 phase, 460 V, 60 Hz
★1 Cooling capacity	Nominal	Btu/h (kW)	216,000 (63.3)	238,000 (69.8)
	Rated		206,000 (60.4)	228,000 (66.8)
★2 Heating capacity	Nominal	Btu/h (kW)	243,000 (71.2)	270,000 (79.1)
	Rated		206,000 (60.4)	220,000 (64.5)
Casing color			Ivory white (5Y7.5/1)	Ivory white (5Y7.5/1)
Dimensions: (H × W × D)		in. (mm)	65-3/8 × 68-7/8 × 30-1/8 (1,660 × 1,750 × 765)	65-3/8 × 68-7/8 × 30-1/8 (1,660 × 1,750 × 765)
Heat exchanger			Cross fin coil	Cross fin coil
Compressor	Type		Hermetically sealed scroll type	Hermetically sealed scroll type
	Volume	m <sup>3</sup> /h	21.3 + 21.3	24.7 + 24.7
	Number of revolutions	r/min	6,294 + 6,294	7,272 + 7,272
	Motor output	kW	6.56 + 6.56	7.58 + 7.58
	Starting method		Soft start	Soft start
Fan	Type		Propeller fan	Propeller fan
	Motor output × Number of units	kW	0.95 × 2	0.95 × 2
	Airflow rate	cfm (m <sup>3</sup> /min)	14,505 (410.8)	14,505 (410.8)
	Drive		Direct drive	Direct drive
	Connecting pipes			
	Liquid pipe	in. (mm)	ϕ 5/8 (15.9) C1220T (brazing connection)	ϕ 5/8 (15.9) C1220T (brazing connection)
	Suction gas pipe	in. (mm)	ϕ 1-1/8 (28.6) C1220T (brazing connection)	ϕ 1-3/8 (34.9) C1220T (brazing connection)
	High/Low pressure gas pipe	in. (mm)	ϕ 1-1/8 (28.6) C1220T (brazing connection)	ϕ 1-1/8 (28.6) C1220T (brazing connection)
Weight		lbs (kg)	972 (441)	972 (441)
Sound pressure level (Reference data)		dB(A)	68	69
Sound power level (Reference data)		dB	90	90
Safety devices			High pressure switch, Fan driver overload protector, Overcurrent fuse, Inverter overload protector, Leak detecting device	High pressure switch, Fan driver overload protector, Overcurrent fuse, Inverter overload protector, Leak detecting device
Defrost method			Deicer	Deicer
Capacity control		%	3-100	3-100
Refrigerant	Refrigerant name		R-410A	R-410A
	Charge	lbs (kg)	25.8 (11.7)	25.8 (11.7)
	Control		Electronic expansion valve	Electronic expansion valve
Standard accessories			Installation manual, Operation manual, Connection pipes, Clamps	Installation manual, Operation manual, Connection pipes, Clamps
Drawing No.			4D148476	4D148476

**Notes:**

- ★1. Indoor temp.: 80°FDB (26.7°CDB), 67°FWB (19.4°CWB) / Outdoor temp.: 95°FDB (35.0°CDB) / Rated capacity is certified under AHRI standard 1230.
- ★2. Indoor temp.: 70°FDB (21.1°CDB) / Outdoor temp.: 47°FDB (8.3°CDB), 43°FWB (6.1°CWB) / Rated capacity is certified under AHRI standard 1230.

Model name (Combination unit)		REYQ264AAAYDB		REYQ288AAAYDB		
Model name (Independent unit)		REYQ120AAAYDB REYQ144AAAYDB		REYQ144AAAYDB REYQ144AAAYDB		
Power supply		3 phase, 460 V, 60 Hz		3 phase, 460 V, 60 Hz		
★1 Cooling capacity	Nominal	Btu/h	264,000 (77.4)	286,000 (83.8)		
	Rated	(kW)	252,000 (73.9)	274,000 (80.3)		
★2 Heating capacity	Nominal	Btu/h	297,000 (87.0)	324,000 (95.0)		
	Rated	(kW)	252,000 (73.9)	274,000 (80.3)		
Casing color		Ivory white (5Y7.5/1)		Ivory white (5Y7.5/1)		
Dimensions: (H × W × D)		in. (mm)	65-3/8 × 48-13/16 × 30-1/8 + 65-3/8 × 48-13/16 × 30-1/8 (1,660 × 1,240 × 765 + 1,660 × 1,240 × 765)	65-3/8 × 48-13/16 × 30-1/8 + 65-3/8 × 48-13/16 × 30-1/8 (1,660 × 1,240 × 765 + 1,660 × 1,240 × 765)		
Heat exchanger		Cross fin coil		Cross fin coil		
Compressor	Type	Hermetically sealed scroll type		Hermetically sealed scroll type		
	Volume	m <sup>3</sup> /h	(12.5 + 12.5) + (11.3 + 18.1)	(10.8 + 17.3) + (10.8 + 17.3)		
	Number of revolutions	r/min	(5,892 + 5,892) + (5,334 + 5,334)	(5,094 + 5,094) + (5,094 + 5,094)		
	Motor output	kW	(3.6 + 3.6) + (3.26 + 5.55)	(3.11 + 5.31) + (3.11 + 5.31)		
	Starting method	Soft start		Soft start		
Fan	Type	Propeller fan		Propeller fan		
	Motor output × Number of units	kW	0.65 × 2 + 0.65 × 2	0.65 × 2 + 0.65 × 2		
	Airflow rate	cfm (m <sup>3</sup> /min)	8,965 (253.9) + 9,675 (274)	9,675 (274) + 9,675 (274)		
	Drive	Direct drive		Direct drive		
Connecting pipes	Liquid pipe	in. (mm)	φ 3/4 (19.1) C1220T (brazing connection)	φ 3/4 (19.1) C1220T (brazing connection)		
	Suction gas pipe	in. (mm)	φ 1-3/8 (34.9) C1220T (brazing connection)	φ 1-3/8 (34.9) C1220T (brazing connection)		
	High/Low pressure gas pipe	in. (mm)	φ 1-1/8 (28.6) C1220T (brazing connection)	φ 1-1/8 (28.6) C1220T (brazing connection)		
Weight	lbs (kg)	728 (330) + 800 (363)		800 (363) + 800 (363)		
Sound pressure level (Reference data)	dB(A)	67		69		
Sound power level (Reference data)	dB	88		88		
Safety devices		High pressure switch, Fan driver overload protector, Overcurrent fuse, Inverter overload protector, Leak detecting device		High pressure switch, Fan driver overload protector, Overcurrent fuse, Inverter overload protector, Leak detecting device		
Defrost method		Deicer		Deicer		
Capacity control		%	1-100		1-100	
Refrigerant	Refrigerant name	R-410A		R-410A		
	Charge	lbs (kg)	25.8 (11.7) + 25.8 (11.7)		25.8 (11.7) + 25.8 (11.7)	
	Control	Electronic expansion valve		Electronic expansion valve		
Standard accessories		Installation manual, Operation manual, Connection pipes, Clamps		Installation manual, Operation manual, Connection pipes, Clamps		
Drawing No.		4D148477		4D148477		

**Notes:**

- ★1. Indoor temp.: 80°FDB (26.7°CDB), 67°FWB (19.4°CWB) / Outdoor temp.: 95°FDB (35.0°CDB) / Rated capacity is certified under AHRI standard 1230.  
★2. Indoor temp.: 70°FDB (21.1°CDB) / Outdoor temp.: 47°FDB (8.3°CDB), 43°FWB (6.1°CWB) / Rated capacity is certified under AHRI standard 1230.

Model name (Combination unit)			REYQ312AAAYDB	REYQ336AAAYDB
Model name (Independent unit)			REYQ144AAAYDB REYQ168AAAYDB	REYQ168AAAYDB REYQ168AAAYDB
Power supply			3 phase, 460 V, 60 Hz	3 phase, 460 V, 60 Hz
★1 Cooling capacity	Nominal	Btu/h (kW)	310,000 (90.9)	330,000 (96.7)
	Rated		296,000 (86.7)	316,000 (92.6)
★2 Heating capacity	Nominal	Btu/h (kW)	351,000 (103)	378,000 (111)
	Rated		296,000 (86.7)	310,000 (90.9)
Casing color			Ivory white (5Y7.5/1)	Ivory white (5Y7.5/1)
Dimensions: (H × W × D)		in. (mm)	65-3/8 × 48-13/16 × 30-1/8 + 65-3/8 × 48-13/16 × 30-1/8 (1,660 × 1,240 × 765 + 1,660 × 1,240 × 765)	65-3/8 × 48-13/16 × 30-1/8 + 65-3/8 × 48-13/16 × 30-1/8 (1,660 × 1,240 × 765 + 1,660 × 1,240 × 765)
Heat exchanger			Cross fin coil	Cross fin coil
Compressor	Type		Hermetically sealed scroll type	Hermetically sealed scroll type
	Volume	m <sup>3</sup> /h	(11 + 17.6) + (13.1 + 20.9)	(12.9 + 20.6) + (12.9 + 20.6)
	Number of revolutions	r/min	(5,184 + 5,184) + (6,174 + 6,174)	(6,078 + 6,078) + (6,078 + 6,078)
	Motor output	kW	(3.17 + 5.4) + (3.77 + 6.43)	(3.71 + 6.33) + (3.71 + 6.33)
	Starting method		Soft start	Soft start
Fan	Type		Propeller fan	Propeller fan
	Motor output × Number of units	kW	0.65 × 2 + 0.65 × 2	0.65 × 2 + 0.65 × 2
	Airflow rate	cfm (m <sup>3</sup> /min)	9,675 (274) + 9,675 (274)	9,675 (274) + 9,675 (274)
	Drive		Direct drive	Direct drive
Connecting pipes	Liquid pipe	in. (mm)	φ 3/4 (19.1) C1220T (brazing connection)	φ 3/4 (19.1) C1220T (brazing connection)
	Suction gas pipe	in. (mm)	φ 1-3/8 (34.9) C1220T (brazing connection)	φ 1-3/8 (34.9) C1220T (brazing connection)
	High/Low pressure gas pipe	in. (mm)	φ 1-1/8 (28.6) C1220T (brazing connection)	φ 1-1/8 (28.6) C1220T (brazing connection)
Weight		lbs (kg)	800 (363) + 802 (364)	802 (364) + 802 (364)
Sound pressure level (Reference data)		dB(A)	69	69
Sound power level (Reference data)		dB	89	88
Safety devices			High pressure switch, Fan driver overload protector, Overcurrent fuse, Inverter overload protector, Leak detecting device	High pressure switch, Fan driver overload protector, Overcurrent fuse, Inverter overload protector, Leak detecting device
Defrost method			Deicer	Deicer
Capacity control		%	1-100	1-100
Refrigerant	Refrigerant name		R-410A	R-410A
	Charge	lbs (kg)	25.8 (11.7) + 25.8 (11.7)	25.8 (11.7) + 25.8 (11.7)
	Control		Electronic expansion valve	Electronic expansion valve
Standard accessories			Installation manual, Operation manual, Connection pipes, Clamps	Installation manual, Operation manual, Connection pipes, Clamps
Drawing No.			4D148477	4D148478

**Notes:**

- ★1. Indoor temp.: 80°FDB (26.7°CDB), 67°FWB (19.4°CWB) / Outdoor temp.: 95°FDB (35.0°CDB) / Rated capacity is certified under AHRI standard 1230.
- ★2. Indoor temp.: 70°FDB (21.1°CDB) / Outdoor temp.: 47°FDB (8.3°CDB), 43°FWB (6.1°CWB) / Rated capacity is certified under AHRI standard 1230.



Model name (Combination unit)			REYQ360AAAYDB	REYQ384AAAYDB
Model name (Independent unit)			REYQ168AAAYDB REYQ192AAAYDB	REYQ192AAAYDB REYQ192AAAYDB
Power supply			3 phase, 460 V, 60 Hz	3 phase, 460 V, 60 Hz
★1 Cooling capacity	Nominal	Btu/h (kW)	358,000 (105)	382,000 (112)
	Rated		342,000 (100)	364,000 (107)
★2 Heating capacity	Nominal	Btu/h (kW)	405,000 (119)	432,000 (127)
	Rated		342,000 (100)	364,000 (107)
Casing color			Ivory white (5Y7.5/1)	Ivory white (5Y7.5/1)
Dimensions: (H × W × D)		in. (mm)	65-3/8 × 48-13/16 × 30-1/8 + 65-3/8 × 68-7/8 × 30-1/8 (1,660 × 1,240 × 765 + 1,660 × 1,750 × 765)	65-3/8 × 68-7/8 × 30-1/8 + 65-3/8 × 68-7/8 × 30-1/8 (1,660 × 1,750 × 765 + 1,660 × 1,750 × 765)
Heat exchanger			Cross fin coil	Cross fin coil
Compressor	Type		Hermetically sealed scroll type	Hermetically sealed scroll type
	Volume	m <sup>3</sup> /h	(13.2 + 21.1) + (18 + 18)	(17.2 + 17.2) + (17.2 + 17.2)
	Number of revolutions	r/min	(6,228 + 6,228) + (5,310 + 5,310)	(5,064 + 5,064) + (5,064 + 5,064)
	Motor output	kW	(3.81 + 6.49) + (5.53 + 5.53)	(5.27 + 5.27) + (5.27 + 5.27)
	Starting method		Soft start	Soft start
Fan	Type		Propeller fan	Propeller fan
	Motor output × Number of units	kW	0.65 × 2 + 0.95 × 2	0.95 × 2 + 0.95 × 2
	Airflow rate	cfm (m <sup>3</sup> /min)	9,675 (274) + 13,650 (386.5)	13,650 (386.5) + 13,650 (386.5)
	Drive		Direct drive	Direct drive
Connecting pipes	Liquid pipe	in. (mm)	φ 3/4 (19.1) C1220T (brazing connection)	φ 3/4 (19.1) C1220T (brazing connection)
	Suction gas pipe	in. (mm)	φ 1-5/8 (41.3) C1220T (brazing connection)	φ 1-5/8 (41.3) C1220T (brazing connection)
	High/Low pressure gas pipe	in. (mm)	φ 1-3/8 (34.9) C1220T (brazing connection)	φ 1-3/8 (34.9) C1220T (brazing connection)
Weight		lbs (kg)	802 (364) + 972 (441)	972 (441) + 972 (441)
Sound pressure level (Reference data)		dB(A)	70	71
Sound power level (Reference data)		dB	91	92
Safety devices			High pressure switch, Fan driver overload protector, Overcurrent fuse, Inverter overload protector, Leak detecting device	High pressure switch, Fan driver overload protector, Overcurrent fuse, Inverter overload protector, Leak detecting device
Defrost method			Deicer	Deicer
Capacity control		%	1-100	1-100
Refrigerant	Refrigerant name		R-410A	R-410A
	Charge	lbs (kg)	25.8 (11.7) + 25.8 (11.7)	25.8 (11.7) + 25.8 (11.7)
	Control		Electronic expansion valve	Electronic expansion valve
Standard accessories			Installation manual, Operation manual, Connection pipes, Clamps	Installation manual, Operation manual, Connection pipes, Clamps
Drawing No.			4D148478	4D148478

**Notes:**

- ★1. Indoor temp.: 80°FDB (26.7°CDB), 67°FWB (19.4°CWB) / Outdoor temp.: 95°FDB (35.0°CDB) / Rated capacity is certified under AHRI standard 1230.  
★2. Indoor temp.: 70°FDB (21.1°CDB) / Outdoor temp.: 47°FDB (8.3°CDB), 43°FWB (6.1°CWB) / Rated capacity is certified under AHRI standard 1230.

Model name (Combination unit)		REYQ408AAAYDB		REYQ432AAAYDB		
Model name (Independent unit)		REYQ192AAAYDB REYQ216AAAYDB		REYQ216AAAYDB REYQ216AAAYDB		
Power supply		3 phase, 460 V, 60 Hz		3 phase, 460 V, 60 Hz		
★1 Cooling capacity	Nominal	Btu/h (kW)	406,000 (119)	430,000 (126)		
	Rated		388,000 (114)	410,000 (120)		
★2 Heating capacity	Nominal	Btu/h (kW)	459,000 (135)	486,000 (142)		
	Rated		388,000 (114)	404,000 (118)		
Casing color		Ivory white (5Y7.5/1)		Ivory white (5Y7.5/1)		
Dimensions: (H × W × D)		in. (mm)	65-3/8 × 68-7/8 × 30-1/8 + 65-3/8 × 68-7/8 × 30-1/8 (1,660 × 1,750 × 765 + 1,660 × 1,750 × 765)	65-3/8 × 68-7/8 × 30-1/8 + 65-3/8 × 68-7/8 × 30-1/8 (1,660 × 1,750 × 765 + 1,660 × 1,750 × 765)		
Heat exchanger		Cross fin coil		Cross fin coil		
Compressor	Type	Hermetically sealed scroll type		Hermetically sealed scroll type		
	Volume	m <sup>3</sup> /h	(16.3 + 16.3) + (18.5 + 18.5)	(17.7 + 17.7) + (17.7 + 17.7)		
	Number of revolutions	r/min	(4,818 + 4,818) + (5,442 + 5,442)	(5,232 + 5,232) + (5,232 + 5,232)		
	Motor output	kW	(5.02 + 5.02) + (5.67 + 5.67)	(5.45 + 5.45) + (5.45 + 5.45)		
	Starting method	Soft start		Soft start		
Fan	Type	Propeller fan		Propeller fan		
	Motor output × Number of units	kW	0.95 × 2 + 0.95 × 2	0.95 × 2 + 0.95 × 2		
	Airflow rate	cfm (m <sup>3</sup> /min)	13,650 (386.5) + 14,505 (410.8)	14,505 (410.8) + 14,505 (410.8)		
	Drive	Direct drive		Direct drive		
Connecting pipes	Liquid pipe	in. (mm)	φ 3/4 (19.1) C1220T (brazing connection)	φ 3/4 (19.1) C1220T (brazing connection)		
	Suction gas pipe	in. (mm)	φ 1-5/8 (41.3) C1220T (brazing connection)	φ 1-5/8 (41.3) C1220T (brazing connection)		
	High/Low pressure gas pipe	in. (mm)	φ 1-3/8 (34.9) C1220T (brazing connection)	φ 1-3/8 (34.9) C1220T (brazing connection)		
Weight	lbs (kg)	972 (441) + 972 (441)		972 (441) + 972 (441)		
Sound pressure level (Reference data)	dB(A)	71		72		
Sound power level (Reference data)	dB	93		95		
Safety devices		High pressure switch, Fan driver overload protector, Overcurrent fuse, Inverter overload protector, Leak detecting device		High pressure switch, Fan driver overload protector, Overcurrent fuse, Inverter overload protector, Leak detecting device		
Defrost method		Deicer		Deicer		
Capacity control		%	1-100		1-100	
Refrigerant	Refrigerant name	R-410A		R-410A		
	Charge	lbs (kg)	25.8 (11.7) + 25.8 (11.7)		25.8 (11.7) + 25.8 (11.7)	
	Control	Electronic expansion valve		Electronic expansion valve		
Standard accessories		Installation manual, Operation manual, Connection pipes, Clamps		Installation manual, Operation manual, Connection pipes, Clamps		
Drawing No.		4D148479		4D148479		

**Notes:**

- ★1. Indoor temp.: 80°FDB (26.7°CDB), 67°FWB (19.4°CWB) / Outdoor temp.: 95°FDB (35.0°CDB) / Rated capacity is certified under AHRI standard 1230.
- ★2. Indoor temp.: 70°FDB (21.1°CDB) / Outdoor temp.: 47°FDB (8.3°CDB), 43°FWB (6.1°CWB) / Rated capacity is certified under AHRI standard 1230.

Model name (Combination unit)		REYQ456AAAYDB		REYQ480AAAYDB		
Model name (Independent unit)		REYQ216AAAYDB REYQ240AAAYDB		REYQ240AAAYDB REYQ240AAAYDB		
Power supply		3 phase, 460 V, 60 Hz		3 phase, 460 V, 60 Hz		
★1 Cooling capacity	Nominal	Btu/h	454,000 (133)	472,000 (138)		
	Rated	(kW)	434,000 (127)	450,000 (132)		
★2 Heating capacity	Nominal	Btu/h	513,000 (150)	540,000 (158)		
	Rated	(kW)	414,000 (121)	418,000 (123)		
Casing color		Ivory white (5Y7.5/1)		Ivory white (5Y7.5/1)		
Dimensions: (H × W × D)		in. (mm)	65-3/8 × 68-7/8 × 30-1/8 + 65-3/8 × 68-7/8 × 30-1/8 (1,660 × 1,750 × 765 + 1,660 × 1,750 × 765)	65-3/8 × 68-7/8 × 30-1/8 + 65-3/8 × 68-7/8 × 30-1/8 (1,660 × 1,750 × 765 + 1,660 × 1,750 × 765)		
Heat exchanger		Cross fin coil		Cross fin coil		
Compressor	Type	Hermetically sealed scroll type		Hermetically sealed scroll type		
	Volume	m <sup>3</sup> /h	(17.5 + 17.5) + (20 + 20)	(20.4 + 20.4) + (20.4 + 20.4)		
	Number of revolutions	r/min	(5,154 + 5,154) + (5,886 + 5,886)	(6,018 + 6,018) + (6,018 + 6,018)		
	Motor output	kW	(5.37 + 5.37) + (6.13 + 6.13)	(6.27 + 6.27) + (6.27 + 6.27)		
	Starting method	Soft start		Soft start		
Fan	Type	Propeller fan		Propeller fan		
	Motor output × Number of units	kW	0.95 × 2 + 0.95 × 2	0.95 × 2 + 0.95 × 2		
	Airflow rate	cfm (m <sup>3</sup> /min)	14,505 (410.8) + 14,505 (410.8)	14,505 (410.8) + 14,505 (410.8)		
	Drive	Direct drive		Direct drive		
Connecting pipes	Liquid pipe	in. (mm)	φ 3/4 (19.1) C1220T (brazing connection)	φ 3/4 (19.1) C1220T (brazing connection)		
	Suction gas pipe	in. (mm)	φ 1-5/8 (41.3) C1220T (brazing connection)	φ 1-5/8 (41.3) C1220T (brazing connection)		
	High/Low pressure gas pipe	in. (mm)	φ 1-3/8 (34.9) C1220T (brazing connection)	φ 1-3/8 (34.9) C1220T (brazing connection)		
Weight	lbs (kg)	972 (441) + 972 (441)		972 (441) + 972 (441)		
Sound pressure level (Reference data)	dB(A)	72		73		
Sound power level (Reference data)	dB	95		95		
Safety devices		High pressure switch, Fan driver overload protector, Overcurrent fuse, Inverter overload protector, Leak detecting device		High pressure switch, Fan driver overload protector, Overcurrent fuse, Inverter overload protector, Leak detecting device		
Defrost method		Deicer		Deicer		
Capacity control		%	1-100		1-100	
Refrigerant	Refrigerant name		R-410A		R-410A	
	Charge	lbs (kg)	25.8 (11.7) + 25.8 (11.7)		25.8 (11.7) + 25.8 (11.7)	
	Control		Electronic expansion valve		Electronic expansion valve	
Standard accessories		Installation manual, Operation manual, Connection pipes, Clamps		Installation manual, Operation manual, Connection pipes, Clamps		
Drawing No.		4D148479		4D148480		

**Notes:**

- ★1. Indoor temp.: 80°FDB (26.7°CDB), 67°FWB (19.4°CWB) / Outdoor temp.: 95°FDB (35.0°CDB) / Rated capacity is certified under AHRI standard 1230.  
★2. Indoor temp.: 70°FDB (21.1°CDB) / Outdoor temp.: 47°FDB (8.3°CDB), 43°FWB (6.1°CWB) / Rated capacity is certified under AHRI standard 1230.

---

# Part 2

# Refrigerant Circuit

1. Refrigerant Circuit (Piping Diagrams) .....	58
1.1 Outdoor Unit .....	58
1.2 Branch Selector Unit .....	67
1.3 Indoor Unit.....	79
1.4 Outdoor-Air Processing Unit.....	82
2. Functional Parts Layout .....	83
2.1 REYQ72AA .....	83
2.2 REYQ96/120AA .....	85
2.3 REYQ144/168AA .....	88
2.4 REYQ192/216/240AA .....	91
3. Refrigerant Flow for Each Operation Mode.....	94
3.1 REYQ72AA .....	94
3.2 REYQ96/120/144/168AA .....	100
3.3 REYQ192/216/240AA .....	106

# 1. Refrigerant Circuit (Piping Diagrams)

## 1.1 Outdoor Unit

### 1.1.1 REYQ72AA

No. in piping diagram	Electric symbol	Name	Function
(1)	M1C	Compressor	Compressor is operated in multi-steps according to Te and Tc.
(2)	M1F	Fan motor	The fan rotation speed is varied by using inverter.
(3)	Y1E	Electronic expansion valve (Heat exchanger right upper)	While being used as evaporator, PI control is applied to keep the outlet superheating degree of air heat exchanger constant.
(4)	Y2E	Electronic expansion valve (Heat exchanger right lower)	
(5)	Y3E	Electronic expansion valve (Subcooling heat exchanger)	PI control is applied to keep the outlet superheating degree of subcooling heat exchanger constant.
(6)	Y4E	Electronic expansion valve (Receiver gas purge)	Used to collect the refrigerant to receiver.
(7)	Y6E	Electronic expansion valve (Refrigerant cooling IPM)	Used to control the refrigerant flow to cool the diode bridge and power module of the inverter PCB.
(8)	Y7E	Electronic expansion valve (Refrigerant cooling air)	Used to control the refrigerant flow to cool the air inside the electrical component box.
(9)	Y8E	Electronic expansion valve	Not used
(10)	Y1S	Solenoid valve (Oil separator oil return)	Used to return oil from the oil separator to the compressor.
(11)	Y3S	Solenoid valve (Liquid shutoff)	Used to shut off liquid refrigerant flow to the receiver.
(12)	Y4S	Solenoid valve (Accumulator oil return)	Used to return oil from the accumulator to the compressor.
(13)	Y5S	Solenoid valve (Refrigerant adjustment)	Not used
(14)	Y7S	Four way valve (Heat exchanger right lower)	Used to switch outdoor heat exchanger to evaporator or condenser.
(15)	Y8S	Four way valve (HP/LP gas pipe)	Used to switch dual pressure gas pipe to high pressure or low pressure.
(16)	Y10S	Four way valve (Heat exchanger right upper)	Used to switch outdoor heat exchanger to evaporator or condenser.
(17)	Y11S	Solenoid valve (Refrigerant cooling bypass)	Used when Y6E alone does not provide enough cooling.
(18)	S1NPH	High pressure sensor	Used to detect the high pressure.
(19)	S1NPL	Low pressure sensor	Used to detect the low pressure.
(20)	S1PH	High pressure switch	This functions when pressure increases to stop operation and avoid high pressure increase in the fault operation.
(21)	—	Pressure regulating valve (Liquid pipe)	This is used when pressure increases, to prevent any damage on components caused by pressure increase in transport or storage.
(22)	—	Subcooling heat exchanger	Apply subcooling to liquid refrigerant.
(23)	—	Capillary tube	Used to return the refrigerating oil separated through the oil separator to the compressor.
(24)	R1T	Thermistor (Outdoor air)	Used to detect outdoor air temperature, correct discharge pipe temperature and for other purposes.
(25)	R2T	Thermistor (Heat exchanger right upper gas pipe)	This detects temperature of gas pipe for air heat exchanger.
(26)	R3T	Thermistor (Electrical box air outlet)	Used to detect the outlet pipe temperature of refrigerant cooling air.
(27)	R4T	Thermistor (Receiver gas purge)	Used to detect gas pipe temperature of receiver gas purge piping.
(28)	R5T	Thermistor (Suction pipe before accumulator)	Used to detect temperature of the suction pipe before accumulator.

No. in piping diagram	Electric symbol	Name	Function
(29)	R6T	Thermistor (Heat exchanger right upper liquid pipe)	This detects temperature of liquid pipe for air heat exchanger.
(30)	R7T	Thermistor (Heat exchanger right lower liquid pipe)	
(31)	R8T	Thermistor (Heat exchanger right deicer)	Used to detect liquid pipe temperature of air heat exchanger. Used to make judgements on defrost operation.
(32)	R9T	Thermistor (Heat exchanger right lower gas pipe)	This detects temperature of gas pipe for air heat exchanger.
(33)	R10T	Thermistor (Receiver inlet)	Used to detect liquid pipe temperature of receiver inlet.
(34)	R11T	Thermistor (Subcooling heat exchanger liquid pipe)	This detects temperature of liquid pipe for subcooling heat exchanger.
(35)	R12T	Thermistor (Subcooling heat exchanger gas pipe)	This detects temperature of gas pipe for subcooling heat exchanger.
(36)	R17T	Thermistor (M1C discharge pipe)	Used to detect discharge pipe temperature.
(37)	R18T	Thermistor (M1C body)	Detects compressor surface temperature, this switch is activated at surface temperature of 120°C (248°F) or more to stop the compressor.
(38)	R19T	Thermistor (Compressor suction)	Used to detect suction pipe temperature.
(39)	R20T	Thermistor (Box air)	Detects the air temperature inside the electrical component box.

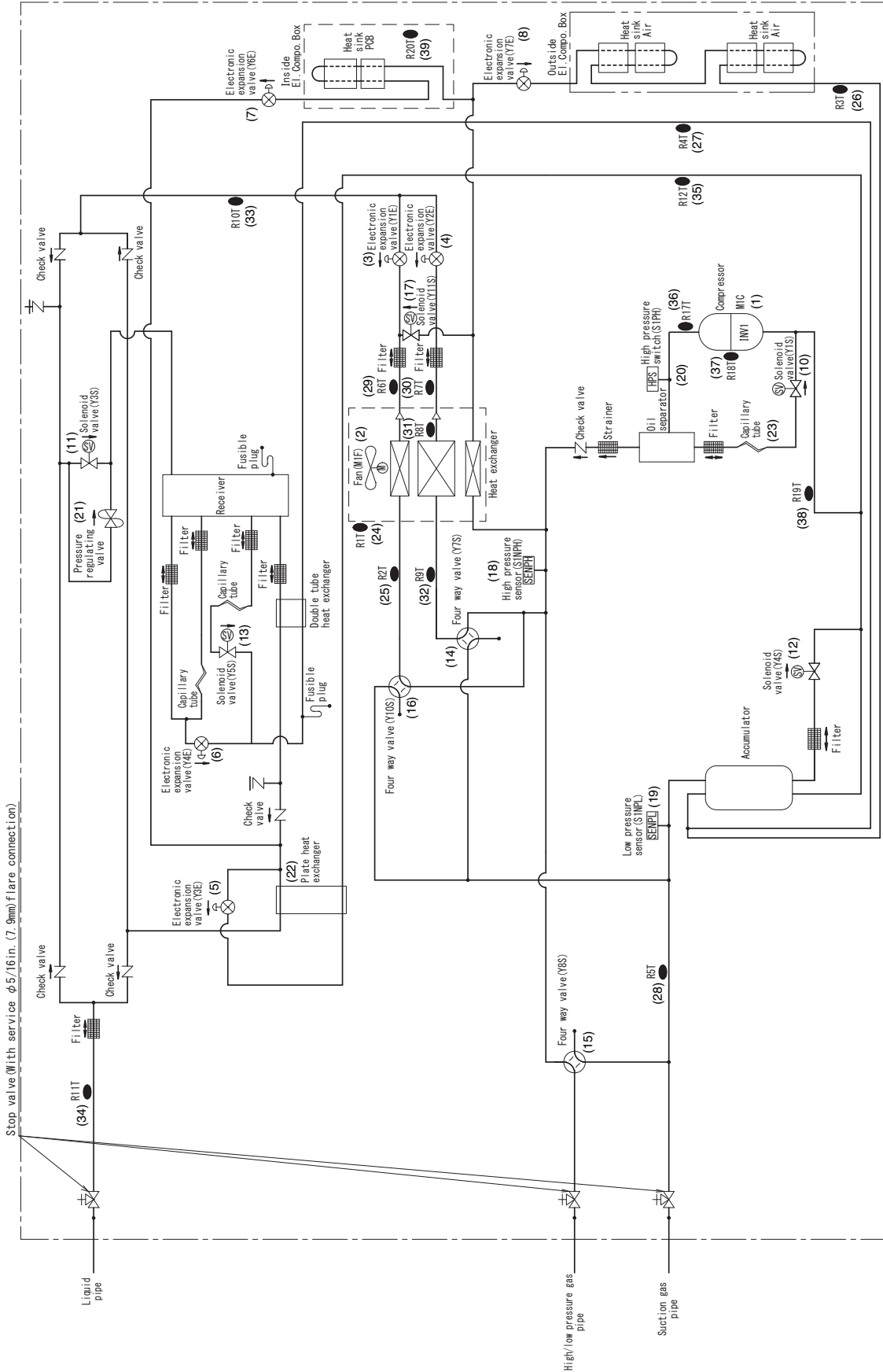

C: 3D135725B

## 1.1.2 REYQ96/120/144/168AA

No. in piping diagram	Electric symbol	Name	Function
(1)	M1C	Compressor 1	Compressor is operated in multi-steps according to Te and Tc.
(2)	M2C	Compressor 2	
(3)	M1F	Fan motor 1	The fan rotation speed is varied by using inverter.
(4)	M2F	Fan motor 2	
(5)	Y1E	Electronic expansion valve (Heat exchanger right upper)	While being used as evaporator, PI control is applied to keep the outlet superheating degree of air heat exchanger constant.
(6)	Y2E	Electronic expansion valve (Heat exchanger right lower)	
(7)	Y3E	Electronic expansion valve (Subcooling heat exchanger)	PI control is applied to keep the outlet superheating degree of subcooling heat exchanger constant.
(8)	Y4E	Electronic expansion valve (Receiver gas purge)	Used to collect the refrigerant to receiver.
(9)	Y6E	Electronic expansion valve (Refrigerant cooling IPM)	Used to control the refrigerant flow to cool the diode bridge and power module of the inverter PCB.
(10)	Y7E	Electronic expansion valve (Refrigerant cooling air)	Used to control the refrigerant flow to cool the air inside the electrical component box.
(11)	Y8E	Electronic expansion valve	Not used
(12)	Y1S	Solenoid valve (Oil separator oil return 2)	Used to return oil from the oil separator to the compressor.
(13)	Y2S	Solenoid valve (Oil separator oil return 1)	
(14)	Y3S	Solenoid valve (Liquid shutoff)	Used to shut off liquid refrigerant flow to the receiver.
(15)	Y4S	Solenoid valve (Accumulator oil return)	Used to return oil from the accumulator to the compressor.
(16)	Y5S	Solenoid valve (Refrigerant adjustment)	Not used
(17)	Y7S	Four way valve (Heat exchanger right lower)	Used to switch outdoor heat exchanger to evaporator or condenser.
(18)	Y8S	Four way valve (HP/LP gas pipe)	Used to switch dual pressure gas pipe to high pressure or low pressure.
(19)	Y10S	Four way valve (Heat exchanger right upper)	Used to switch outdoor heat exchanger to evaporator or condenser.
(20)	Y11S	Solenoid valve (Refrigerant cooling bypass)	Used when Y6E alone does not provide enough cooling.
(21)	S1NPH	High pressure sensor	Used to detect the high pressure.
(22)	S1NPL	Low pressure sensor	Used to detect the low pressure.
(23)	S1PH	High pressure switch	This functions when pressure increases to stop operation and avoid high pressure increase in the fault operation.
(24)	S2PH	High pressure switch	
(25)	—	Pressure regulating valve (Liquid pipe)	This is used when pressure increases, to prevent any damage on components caused by pressure increase in transport or storage.
(26)	—	Subcooling heat exchanger	Apply subcooling to liquid refrigerant.
(27)	—	Capillary tube	Used to return the refrigerating oil separated through the oil separator to the compressor.
(28)	—	Capillary tube	
(29)	R1T	Thermistor (Outdoor air)	Used to detect outdoor air temperature, correct discharge pipe temperature and for other purposes.
(30)	R2T	Thermistor (Heat exchanger right upper gas pipe)	This detects temperature of gas pipe for air heat exchanger.
(31)	R3T	Thermistor (Electrical box air outlet)	Used to detect the outlet pipe temperature of refrigerant cooling air.
(32)	R4T	Thermistor (Receiver gas purge)	Used to detect gas pipe temperature of receiver gas purge piping.
(33)	R5T	Thermistor (Suction pipe before accumulator)	Used to detect temperature of the suction pipe before accumulator.



No. in piping diagram	Electric symbol	Name	Function
(34)	R6T	Thermistor (Heat exchanger right upper liquid pipe)	This detects temperature of liquid pipe for air heat exchanger.
(35)	R7T	Thermistor (Heat exchanger right lower liquid pipe)	
(36)	R8T	Thermistor (Heat exchanger right deicer)	Used to detect liquid pipe temperature of air heat exchanger. Used to make judgements on defrost operation.
(37)	R9T	Thermistor (Heat exchanger right lower gas pipe)	This detects temperature of gas pipe for air heat exchanger.
(38)	R10T	Thermistor (Receiver inlet)	Used to detect liquid pipe temperature of receiver inlet.
(39)	R11T	Thermistor (Subcooling heat exchanger liquid pipe)	This detects temperature of liquid pipe for subcooling heat exchanger.
(40)	R12T	Thermistor (Subcooling heat exchanger gas pipe)	This detects temperature of gas pipe for subcooling heat exchanger.
(41)	R15T	Thermistor (M1C discharge pipe)	Used to detect discharge pipe temperature.
(42)	R16T	Thermistor (M1C body)	Detects compressor surface temperature, this switch is activated at surface temperature of 120°C (248°F) or more to stop the compressor.
(43)	R17T	Thermistor (M2C discharge pipe)	Used to detect discharge pipe temperature.
(44)	R18T	Thermistor (M2C body)	Detects compressor surface temperature, this switch is activated at surface temperature of 120°C (248°F) or more to stop the compressor.
(45)	R19T	Thermistor (Compressor suction)	Used to detect suction pipe temperature.
(46)	R20T	Thermistor (Box air)	Detects the air temperature inside the electrical component box.

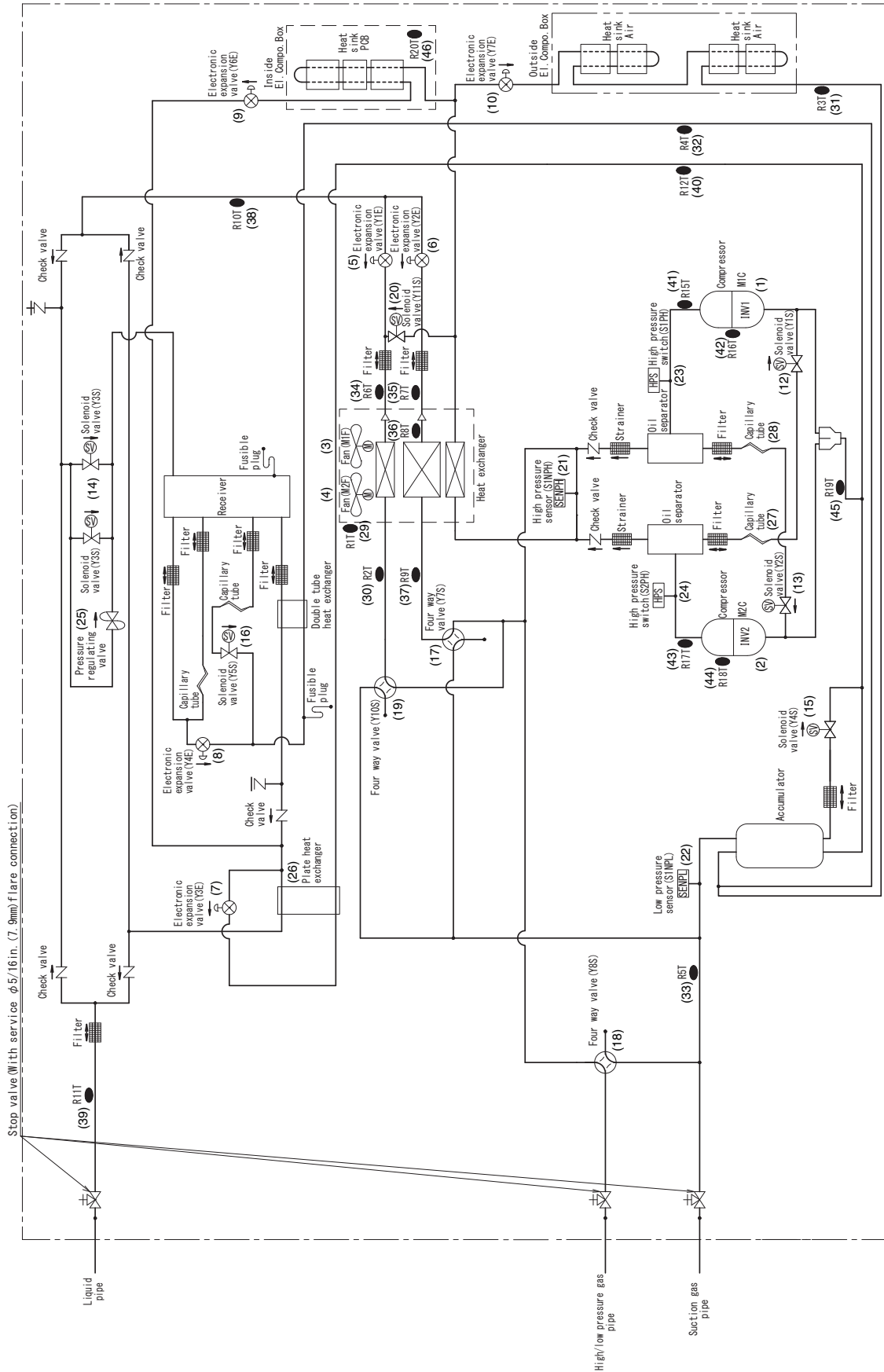

C: 3D135726C

### 1.1.3 REYQ192/216/240AA

No. in piping diagram	Electric symbol	Name	Function
(1)	M1C	Compressor 1	Compressor is operated in multi-steps according to Te and Tc.
(2)	M2C	Compressor 2	
(3)	M1F	Fan motor 1	The fan rotation speed is varied by using inverter.
(4)	M2F	Fan motor 2	
(5)	Y1E	Electronic expansion valve (Heat exchanger right upper)	While being used as evaporator, PI control is applied to keep the outlet superheating degree of air heat exchanger constant.
(6)	Y2E	Electronic expansion valve (Heat exchanger right lower)	
(7)	Y3E	Electronic expansion valve (Subcooling heat exchanger)	PI control is applied to keep the outlet superheating degree of subcooling heat exchanger constant.
(8)	Y4E	Electronic expansion valve (Receiver gas purge)	Used to collect the refrigerant to receiver.
(9)	Y5E	Electronic expansion valve (Heat exchanger left)	While being used as evaporator, PI control is applied to keep the outlet superheating degree of air heat exchanger constant.
(10)	Y6E	Electronic expansion valve (Refrigerant cooling IPM)	Used to control the refrigerant flow to cool the diode bridge and power module of the inverter PCB.
(11)	Y7E	Electronic expansion valve (Refrigerant cooling air)	Used to control the refrigerant flow to cool the air inside the electrical component box.
(12)	Y8E	Electronic expansion valve	Not used
(13)	Y1S	Solenoid valve (Oil separator oil return 2)	Used to return oil from the oil separator to the compressor.
(14)	Y2S	Solenoid valve (Oil separator oil return 1)	
(15)	Y3S	Solenoid valve (Liquid shutoff)	Used to shut off liquid refrigerant flow to the receiver.
(16)	Y4S	Solenoid valve (Accumulator oil return)	Used to return oil from the accumulator to the compressor.
(17)	Y5S	Solenoid valve (Refrigerant adjustment)	Not used
(18)	Y6S	Solenoid valve (Injection)	Used to control compressor injection.
(19)	Y7S	Four way valve (Heat exchanger right lower)	Used to switch outdoor heat exchanger to evaporator or condenser.
(20)	Y8S	Four way valve (HP/LP gas pipe)	Used to switch dual pressure gas pipe to high pressure or low pressure.
(21)	Y9S	Four way valve (Heat exchanger left)	Used to switch outdoor heat exchanger to evaporator or condenser.
(22)	Y10S	Four way valve (Heat exchanger right upper)	
(23)	Y11S	Solenoid valve (Refrigerant cooling bypass)	Used when Y6E alone does not provide enough cooling.
(24)	S1NPH	High pressure sensor	Used to detect the high pressure.
(25)	S1NPL	Low pressure sensor	Used to detect the low pressure.
(26)	S1PH	High pressure switch	This functions when pressure increases to stop operation and avoid high pressure increase in the fault operation.
(27)	S2PH	High pressure switch	
(28)	—	Pressure regulating valve (Liquid pipe)	This is used when pressure increases, to prevent any damage on components caused by pressure increase in transport or storage.
(29)	—	Subcooling heat exchanger	Apply subcooling to liquid refrigerant.
(30)	—	Capillary tube	Used to return the refrigerating oil separated through the oil separator to the compressor.
(31)	—	Capillary tube	
(32)	R1T	Thermistor (Outdoor air)	Used to detect outdoor air temperature, correct discharge pipe temperature and for other purposes.
(33)	R2T	Thermistor (Heat exchanger right upper gas pipe)	This detects temperature of gas pipe for air heat exchanger.
(34)	R3T	Thermistor (Electrical box air outlet)	Used to detect the outlet pipe temperature of refrigerant cooling air.
(35)	R4T	Thermistor (Receiver gas purge)	Used to detect gas pipe temperature of receiver gas purge piping.

No. in piping diagram	Electric symbol	Name	Function
(36)	R5T	Thermistor (Suction pipe before accumulator)	Used to detect temperature of the suction pipe before accumulator.
(37)	R6T	Thermistor (Heat exchanger right upper liquid pipe)	This detects temperature of liquid pipe for air heat exchanger.
(38)	R7T	Thermistor (Heat exchanger right lower liquid pipe)	
(39)	R8T	Thermistor (Heat exchanger right deicer)	Used to detect liquid pipe temperature of air heat exchanger. Used to make judgements on defrost operation.
(40)	R9T	Thermistor (Heat exchanger right lower gas pipe)	This detects temperature of gas pipe for air heat exchanger.
(41)	R10T	Thermistor (Receiver inlet)	Used to detect liquid pipe temperature of receiver inlet.
(42)	R11T	Thermistor (Subcooling heat exchanger liquid pipe)	This detects temperature of liquid pipe for subcooling heat exchanger.
(43)	R12T	Thermistor (Subcooling heat exchanger gas pipe)	This detects temperature of gas pipe for subcooling heat exchanger.
(44)	R14T	Thermistor (Subcooling injection)	
(45)	R15T	Thermistor (M1C discharge pipe)	Used to detect discharge pipe temperature.
(46)	R16T	Thermistor (M1C body)	Detects compressor surface temperature, this switch is activated at surface temperature of 120°C (248°F) or more to stop the compressor.
(47)	R17T	Thermistor (M2C discharge pipe)	Used to detect discharge pipe temperature.
(48)	R18T	Thermistor (M2C body)	Detects compressor surface temperature, this switch is activated at surface temperature of 120°C (248°F) or more to stop the compressor.
(49)	R19T	Thermistor (Compressor suction)	Used to detect suction pipe temperature.
(50)	R20T	Thermistor (Box air)	Detects the air temperature inside the electrical component box.
(51)	R21T	Thermistor (Heat exchanger left gas pipe)	This detects temperature of gas pipe for air heat exchanger.
(52)	R22T	Thermistor (Heat exchanger left liquid pipe)	This detects temperature of liquid pipe for air heat exchanger.
(53)	R23T	Thermistor (Heat exchanger left deicer)	Used to detect liquid pipe temperature of air heat exchanger. Used to make judgements on defrost operation.

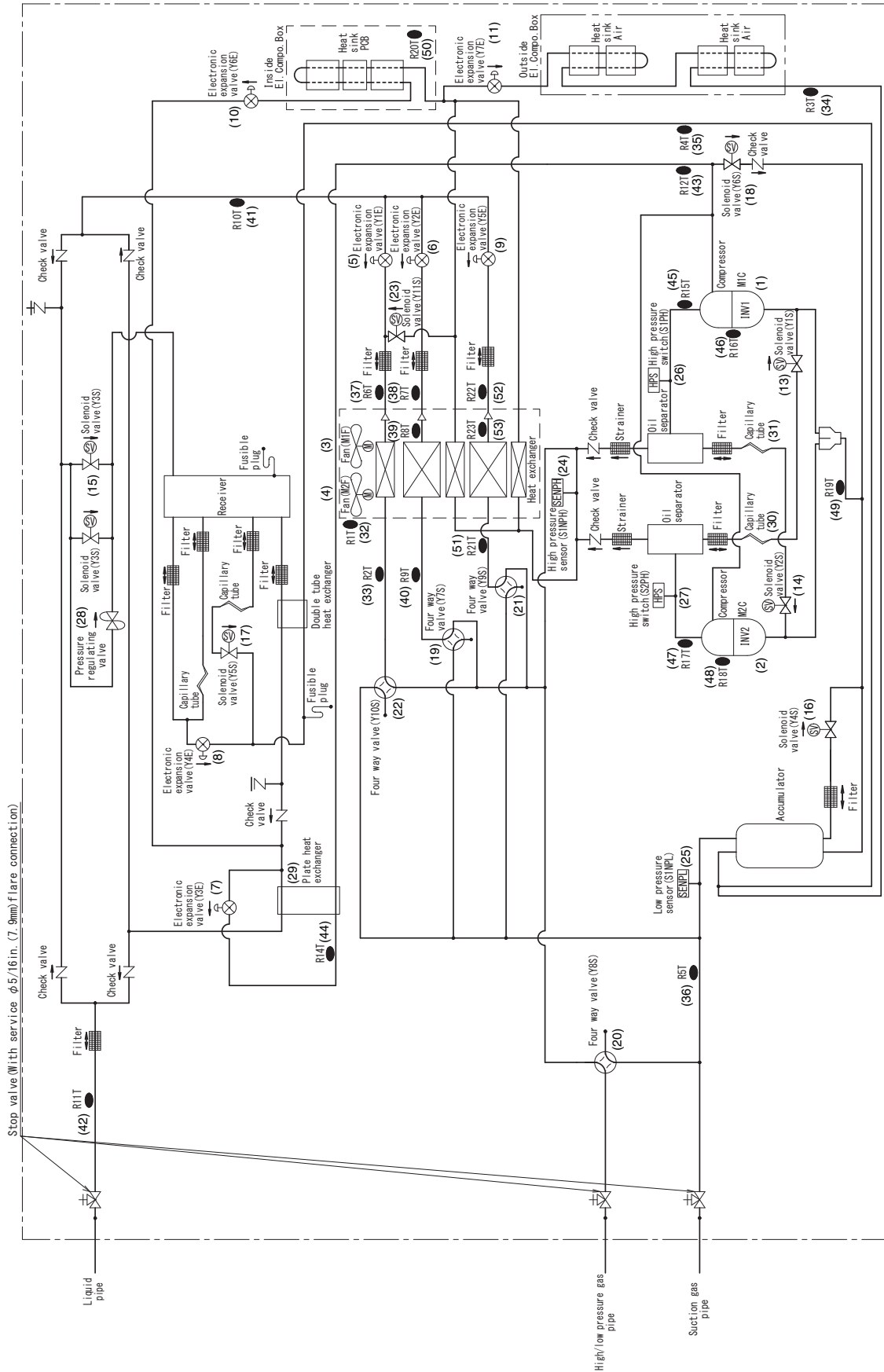

C: 3D135727C

## 1.2 Branch Selector Unit

No.	Name	Electric Symbol	Function
(1)	Electronic expansion valve (EVSC)	Y1E	In simultaneous cooling and heating, it is used to subcooling liquid refrigerants when an indoor unit downstream of this Branch Selector unit is in heating. (Max : 480 pulse)
(2)	Electronic expansion valve (EVH)	Y2E	Opens while in heating or all indoor units are in cooling. (Max : 6,000 pulse)
(3)	Electronic expansion valve (EVL)	Y3E	Opens while in cooling. (Max : 6,000 pulse)



**Note(s)** Factory setting of each electronic expansion valve opening  
 EVSC: 0 pulse  
 EVH, EVL: 3,000 pulse

### 1.2.1 Single Branch Selector Unit

BSQ36/60/96TVJ

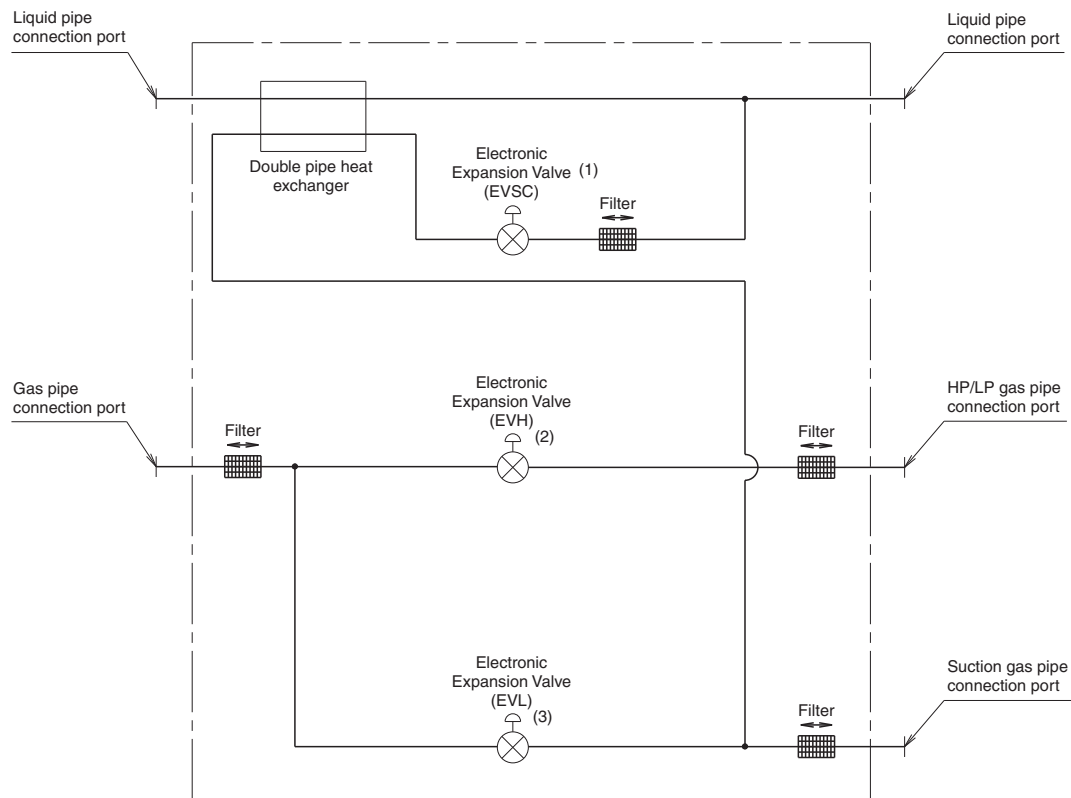

C: 4D085545B

BSQ36/60/96TAVJ

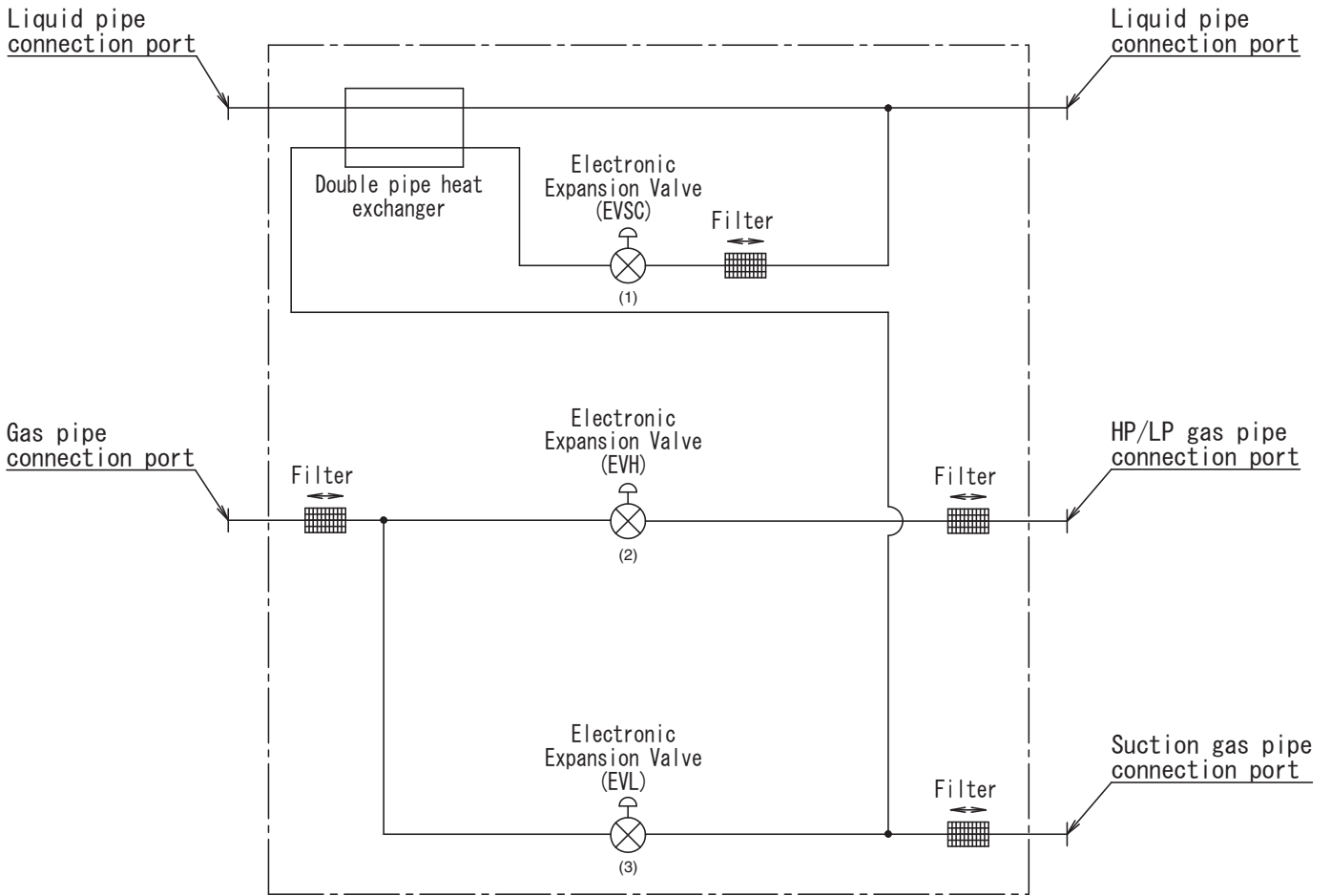

C: 4D133271

## 1.2.2 Multi Branch Selector Unit (Standard Series)

### BS4Q54TVJ

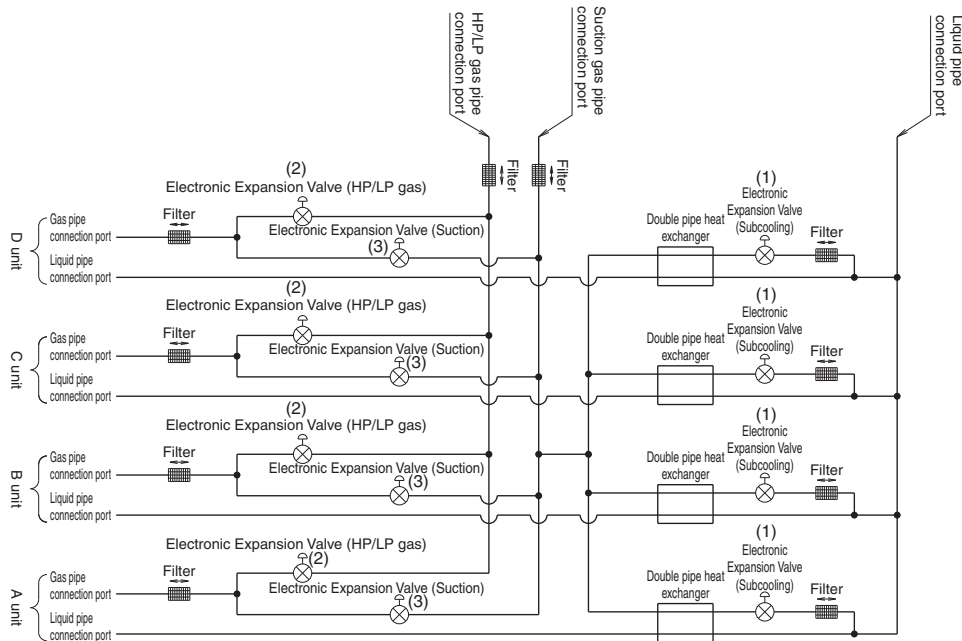

C: 3D086032B

### BS4Q54TAVJ

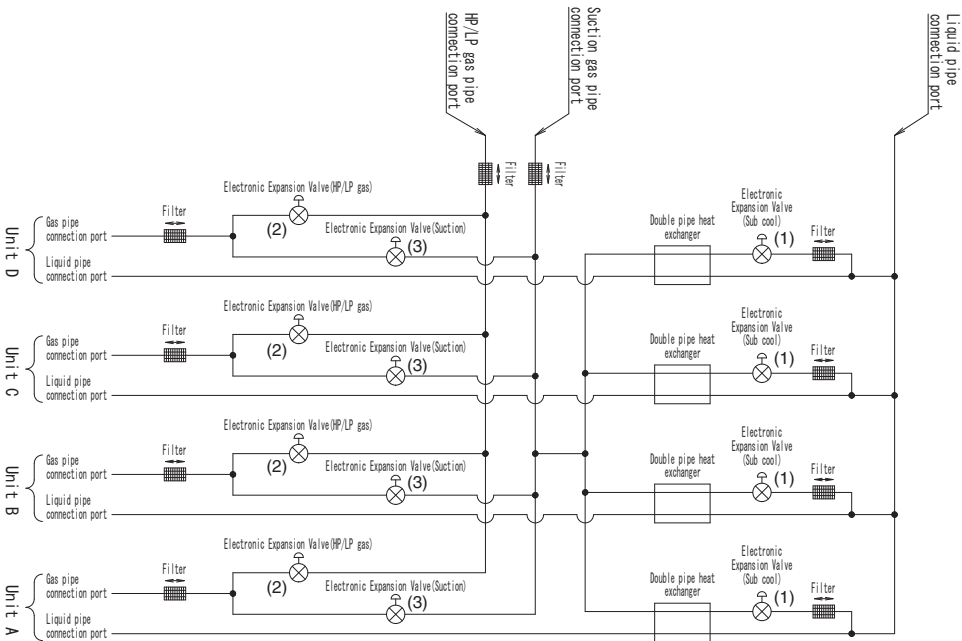

C: 3D133292



BS6Q54TVJ

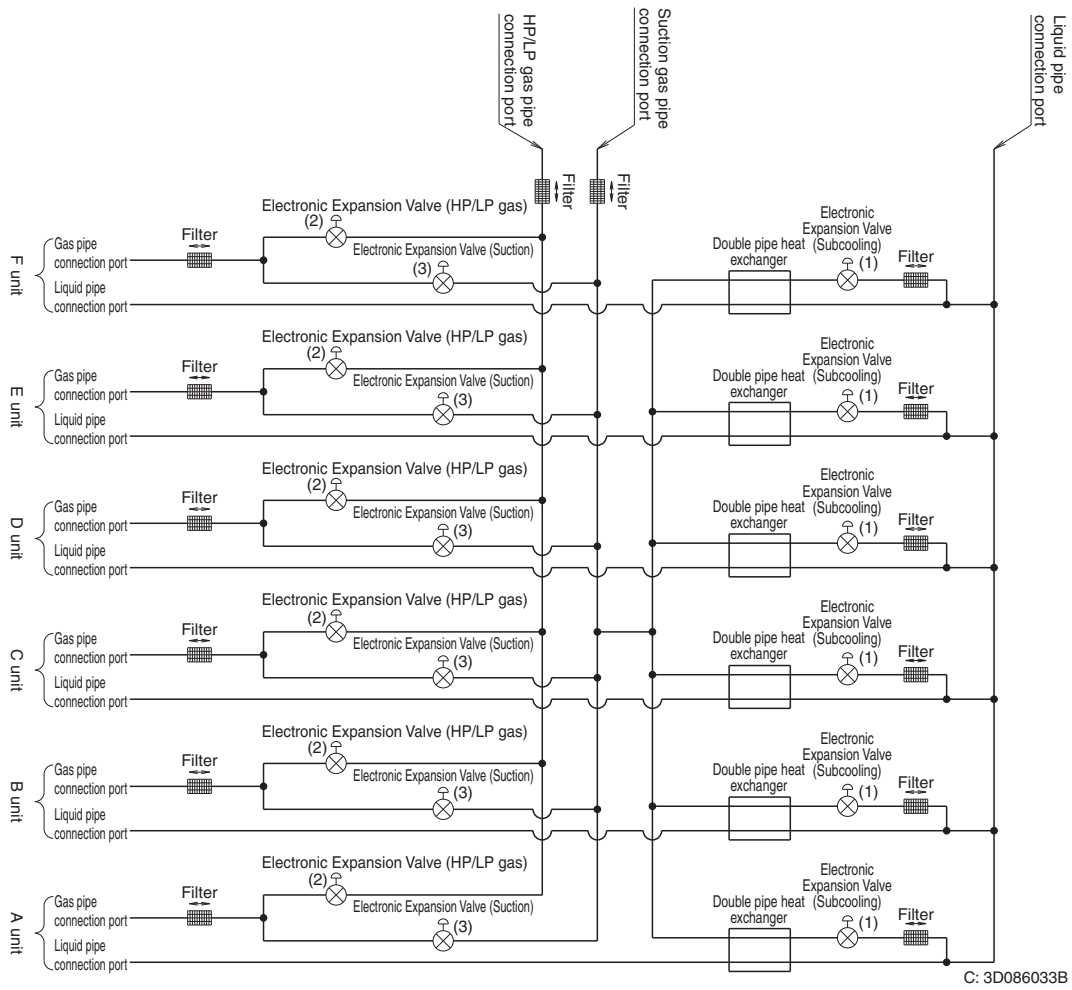

BS8Q54TVJ

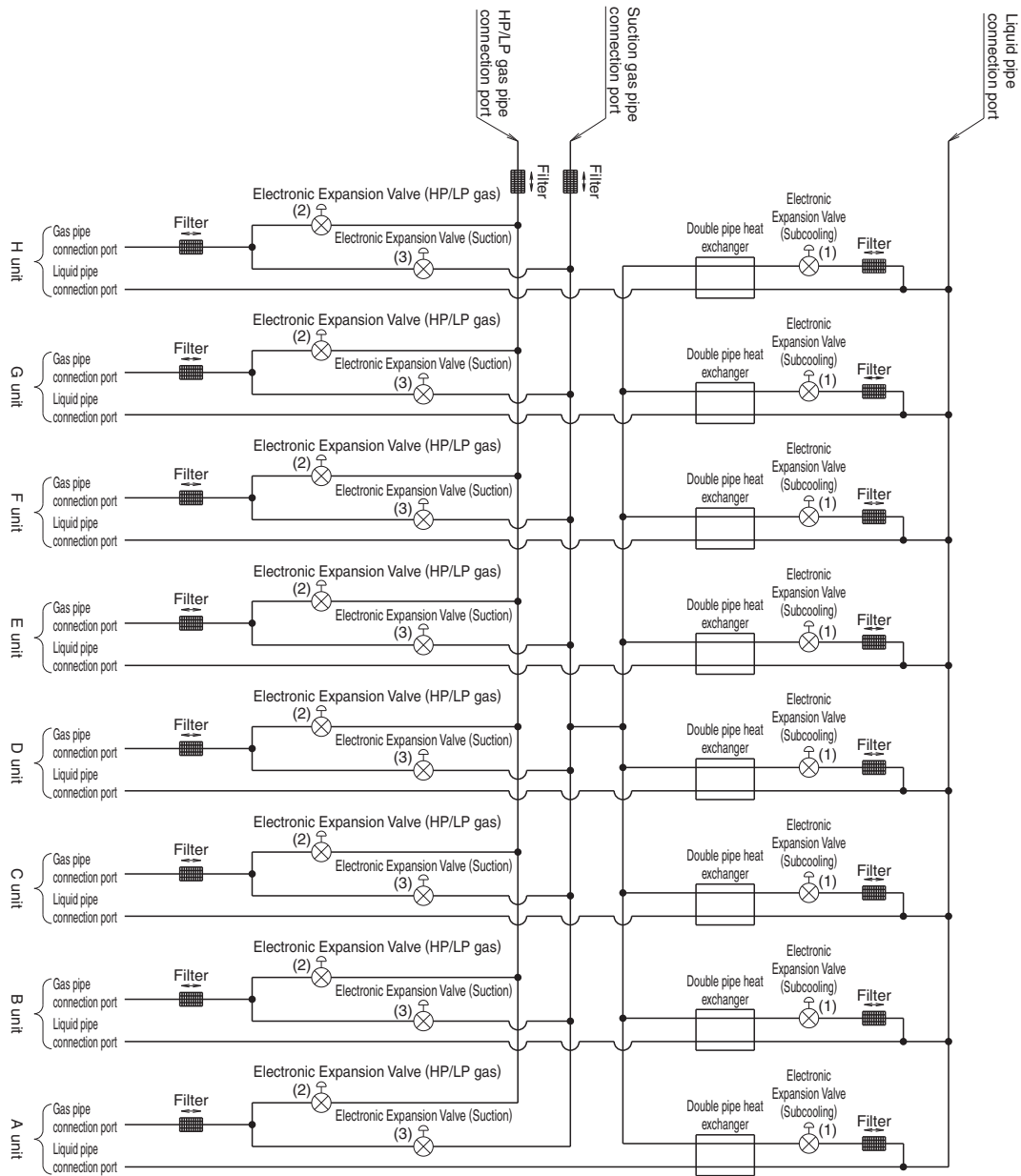

C: 3D086034B

BS10Q54TVJ

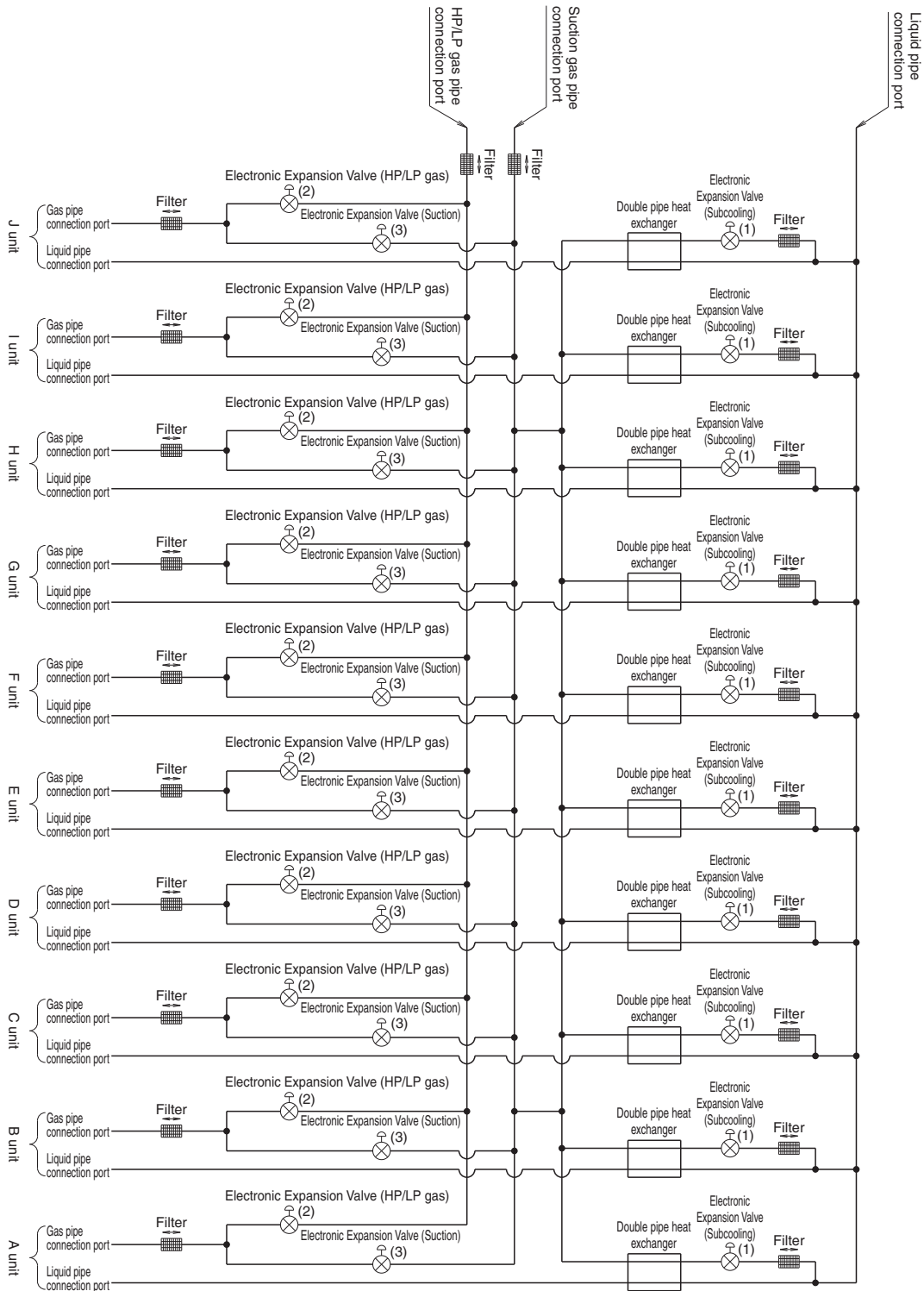

C: 3D086035B

BS10Q54TAVJ

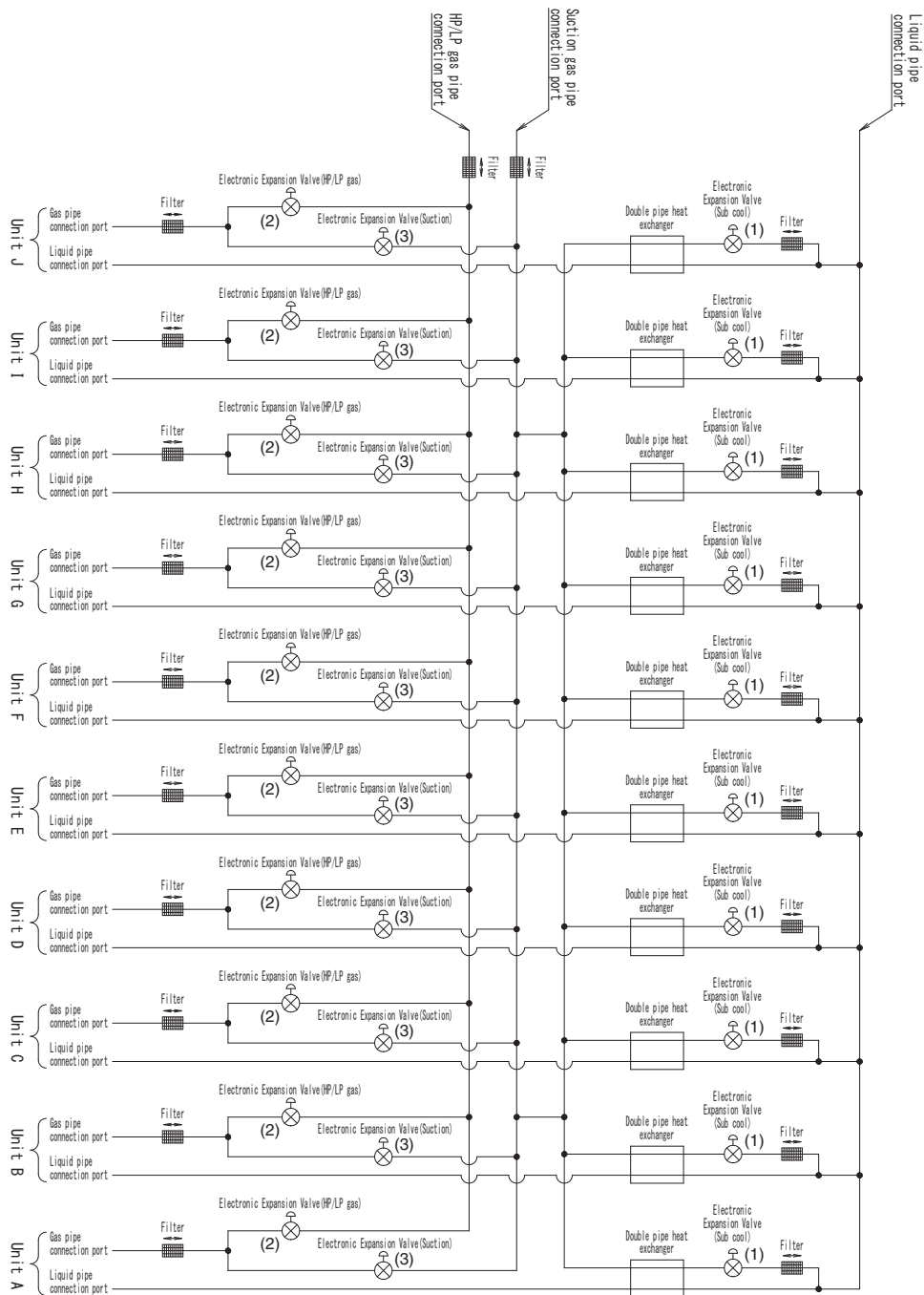

C: 3D133293

BS12Q54TVJ

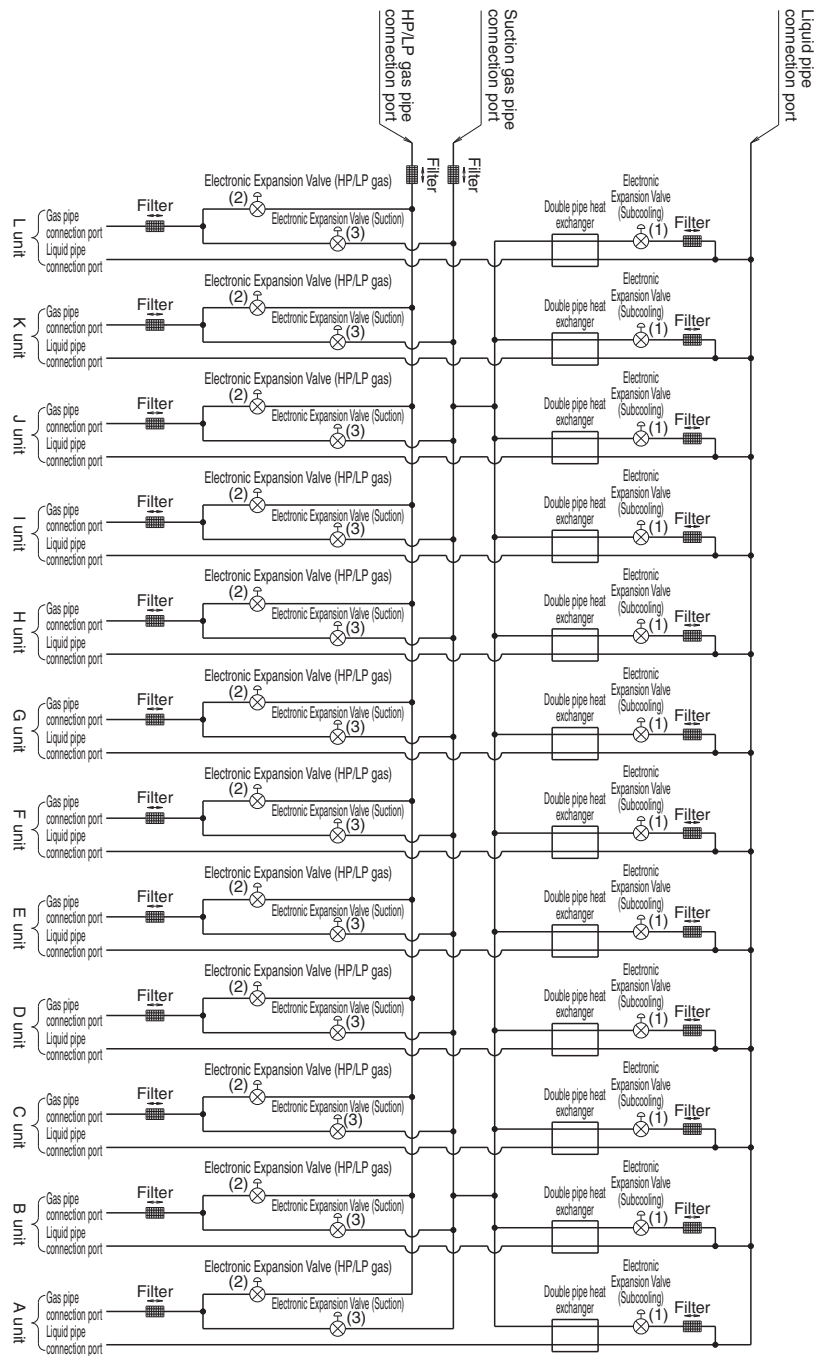

C: 3D086036B

BS12Q54TAVJ

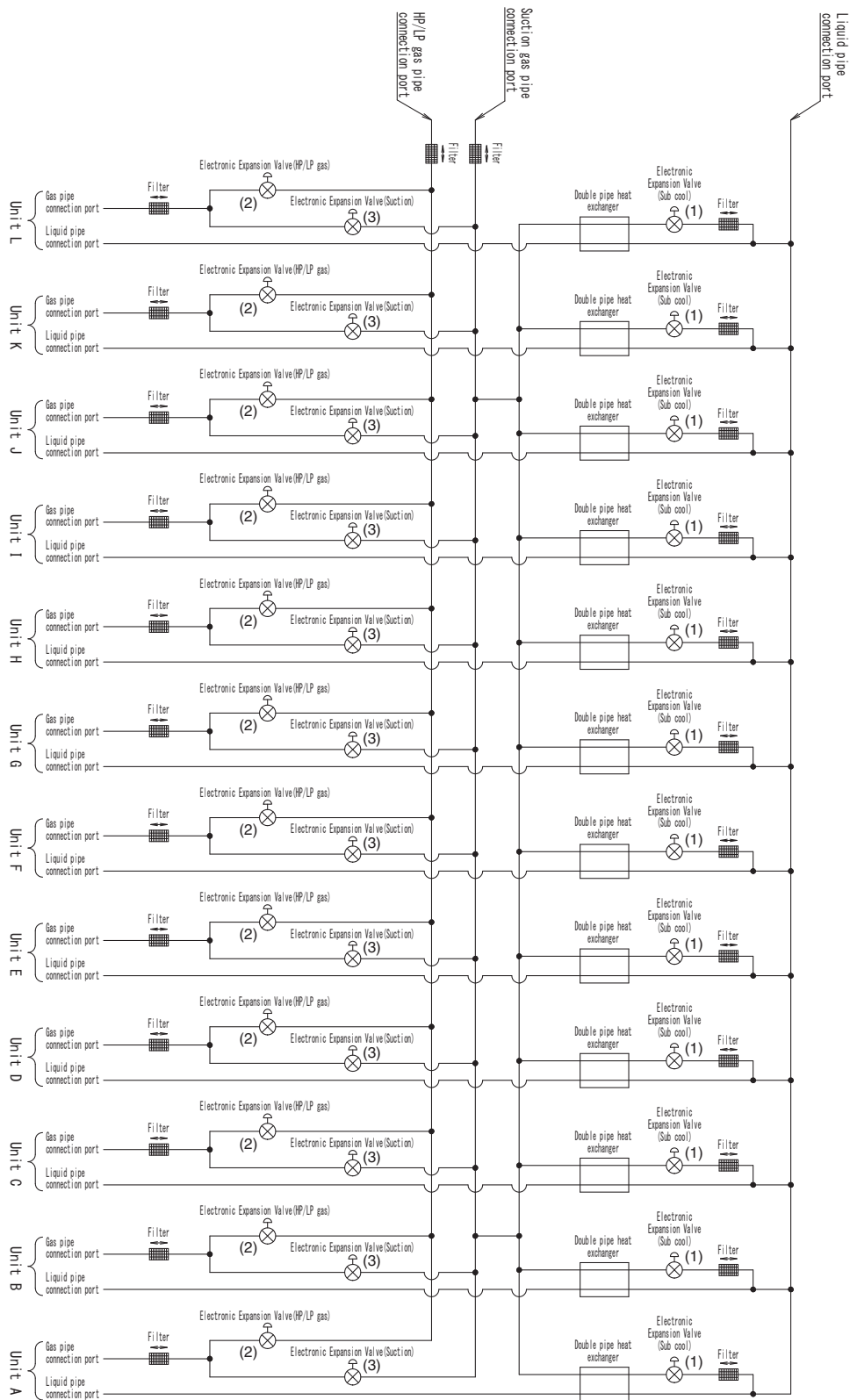

C: 3D133294

### 1.2.3 Multi Branch Selector Unit (Flex Series)

BSF4Q54TVJ

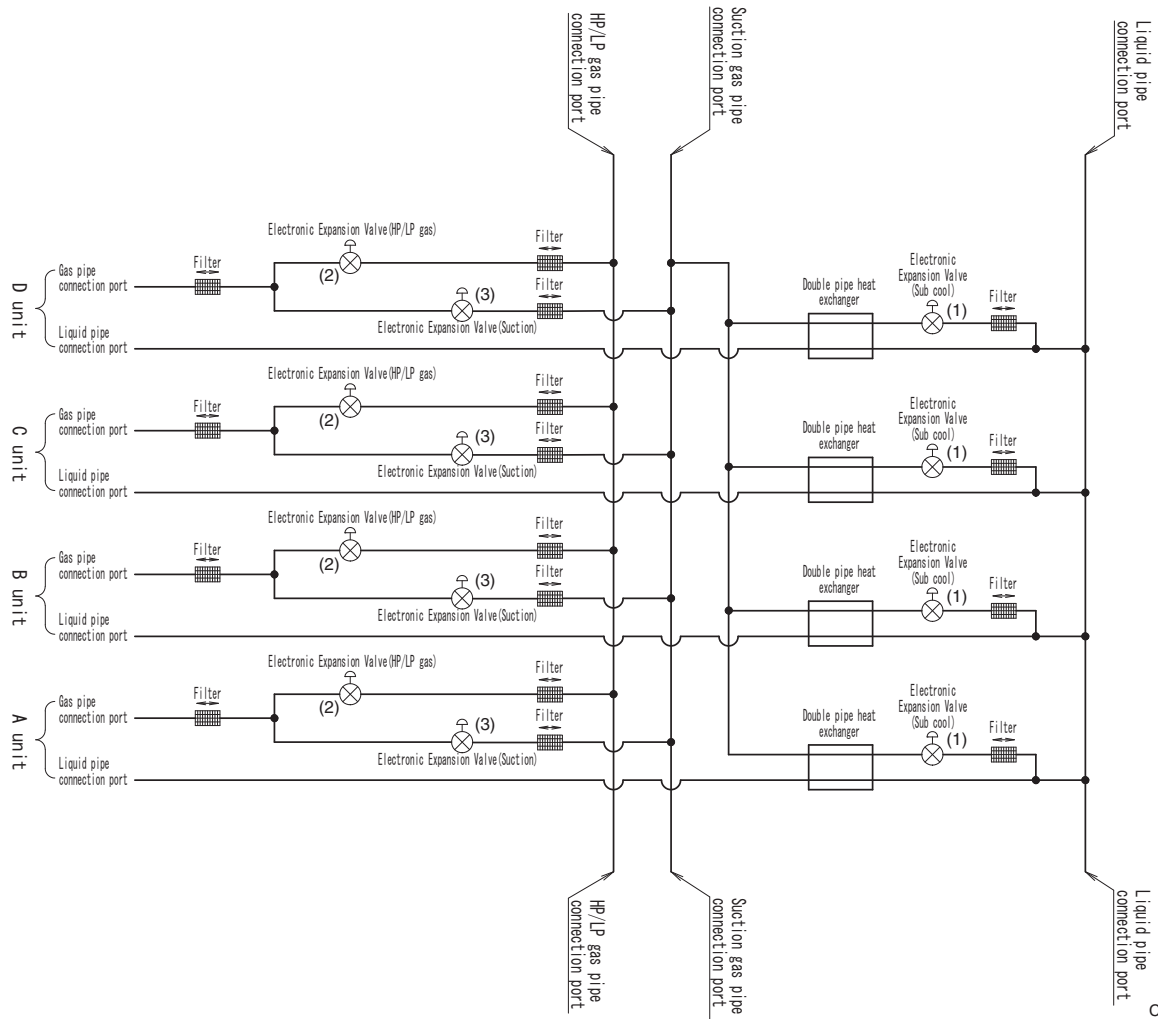

C: 3D122813

BSF6Q54TVJ

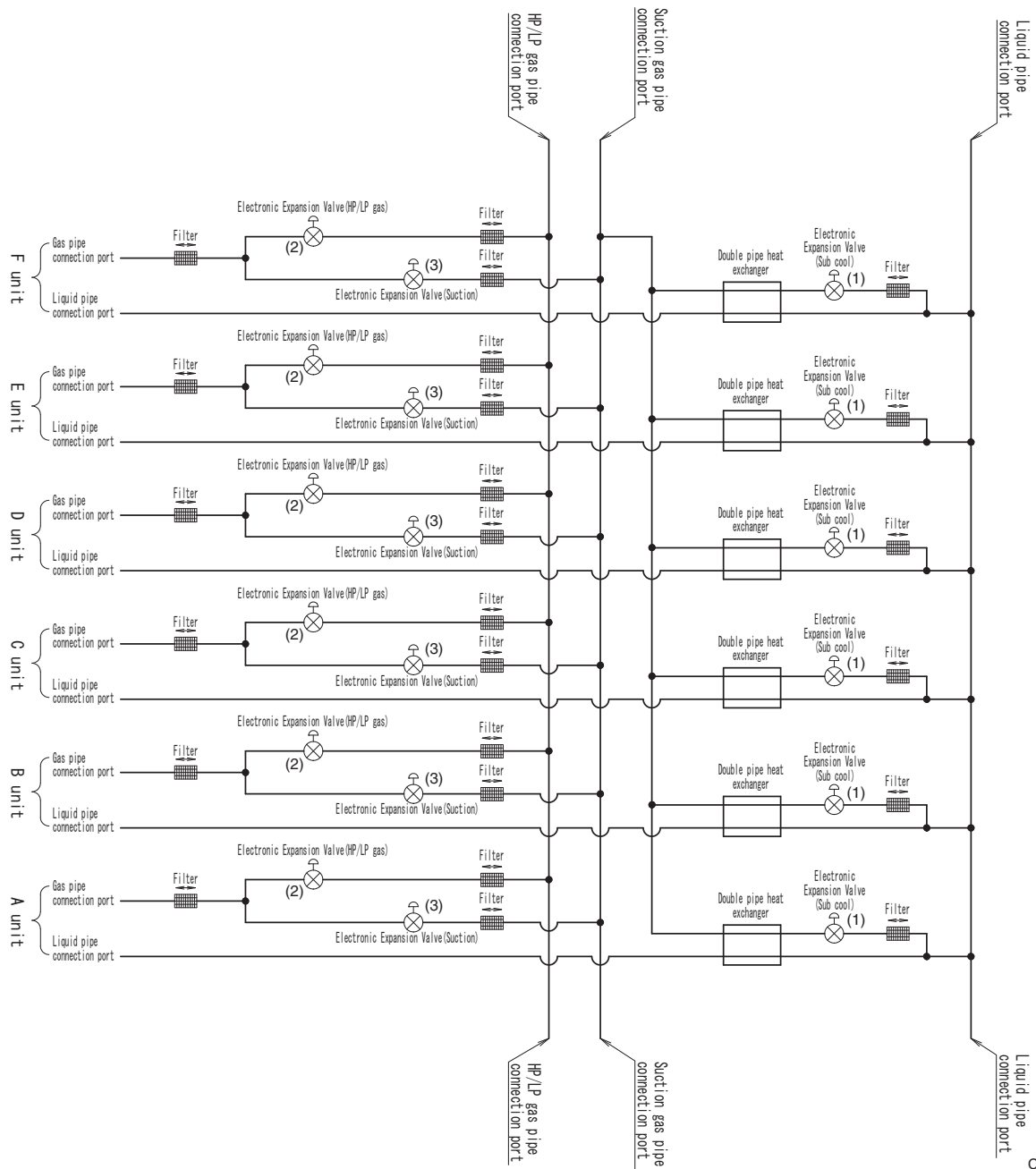

C: 3D125655



BSF8Q54TVJ

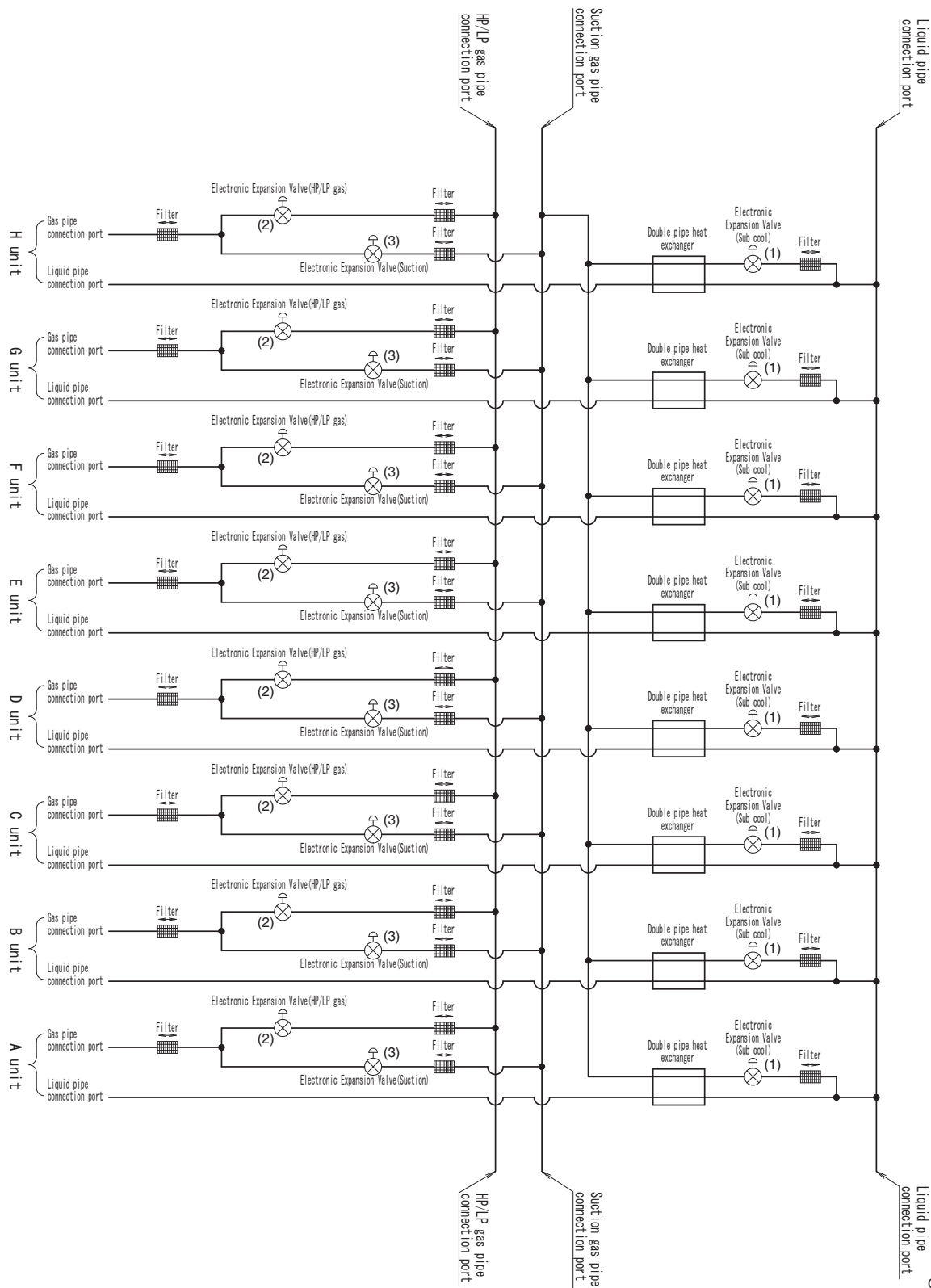

C: 3D125656

### 1.3 Indoor Unit

No. in piping diagram	Name	Symbol			Function
		Except FXMQ-PB FXTQ-TA FXTQ-TB CXTQ-TA	FXMQ-PB	FXTQ-TA FXTQ-TB CXTQ-TA	
(1)	Electronic expansion valve	Y1E	Y1E	Y1E	Used for gas superheating degree control while in cooling or subcooling degree control while in heating.
(2)	Suction air thermistor	R1T	R1T	R1T (*1)	Used for thermostat control.
(3)	Liquid pipe thermistor	R2T	R2T	R2T	Used for gas superheating degree control while in cooling or subcooling degree control while in heating.
(4)	Gas pipe thermistor	R3T	R3T	R3T	Used for gas superheating degree control while in cooling.
(5)	Discharge air thermistor	—	R4T	—	Used for discharge air temperature control.

\*1. R1T is for remote controller thermistor or optional remote sensor.

■ FXFQ-AA

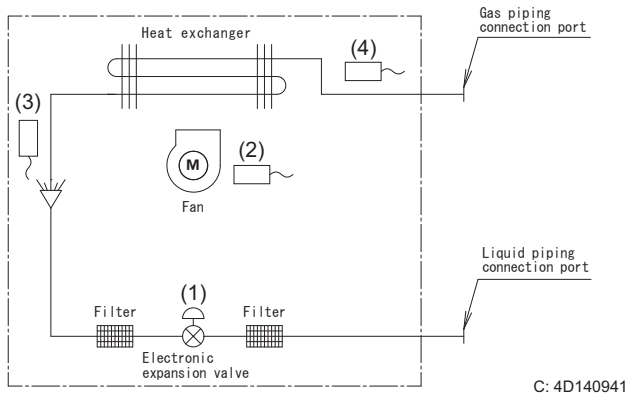

■ FXFQ-T, FXHQ-M

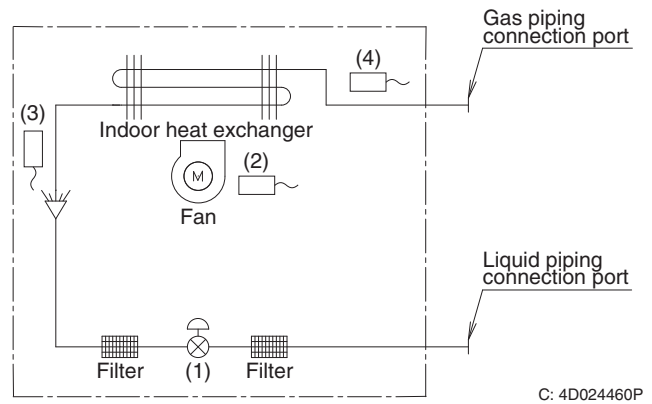

■ FXZQ-TA

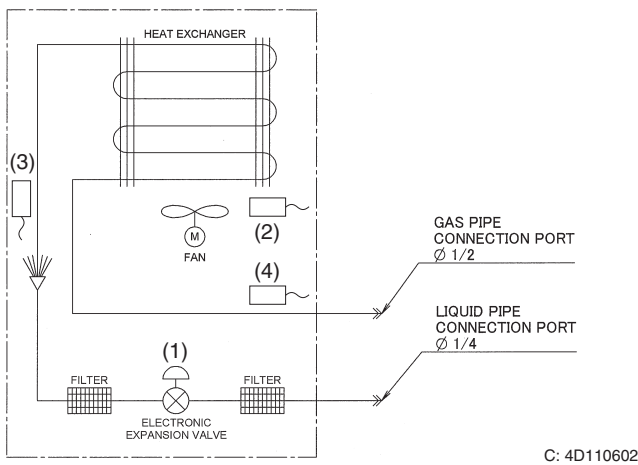

■ FXZQ-TB

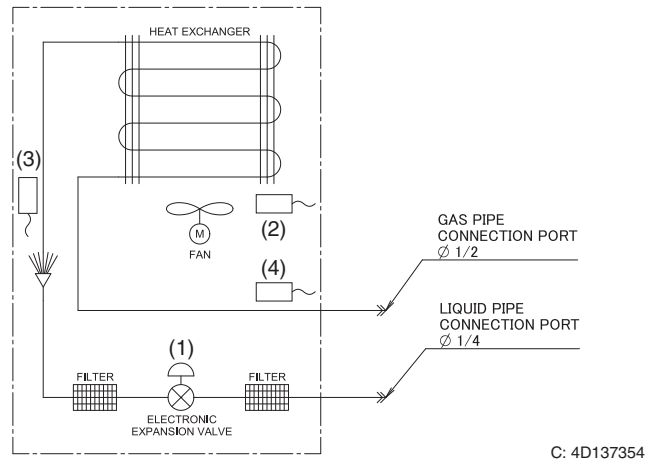

■ FXUQ-P, FXEQ-P, FXSQ-TA, FXMQ-M, FXAQ-P, FXLQ-M, FXNQ-M

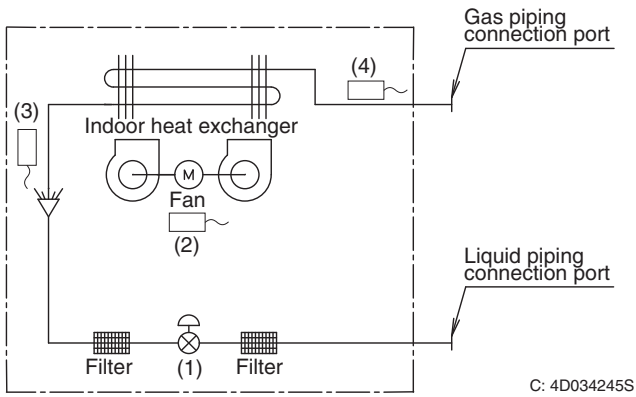

■ FXUQ-PA

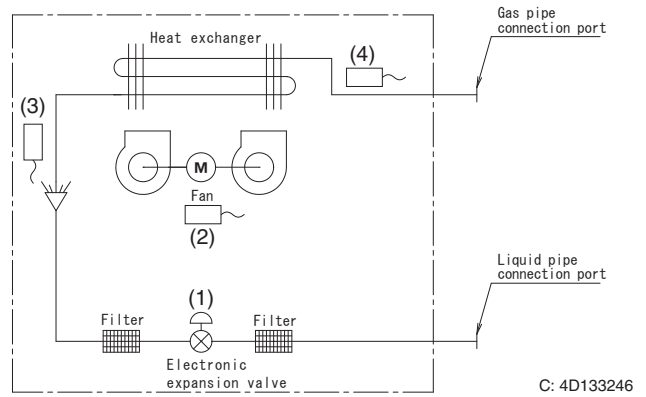

■ FXSQ-TB, FXMQ-TB

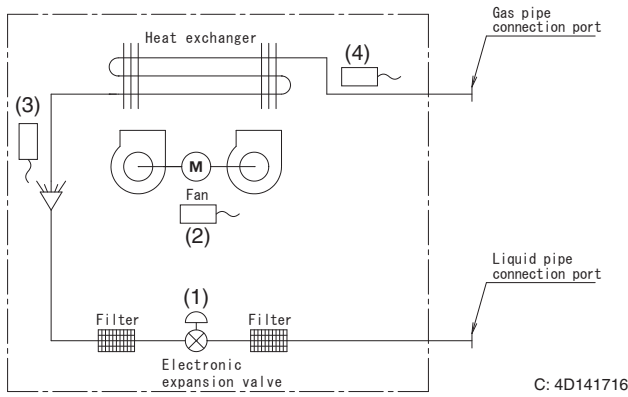

■ FXDQ-M

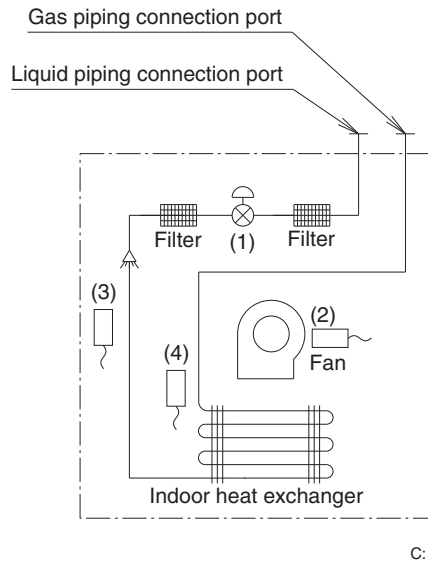

■ FXMQ-PB

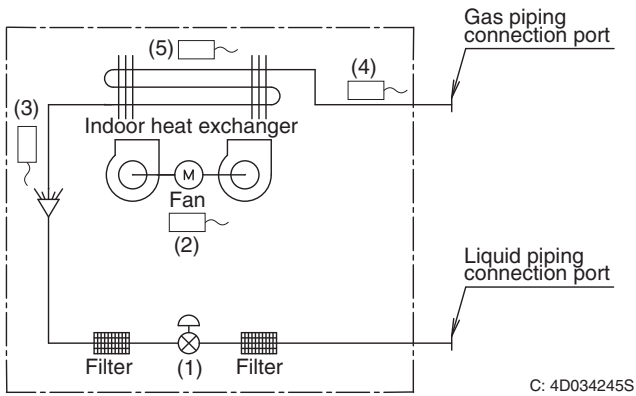

■ FXMQ-TA

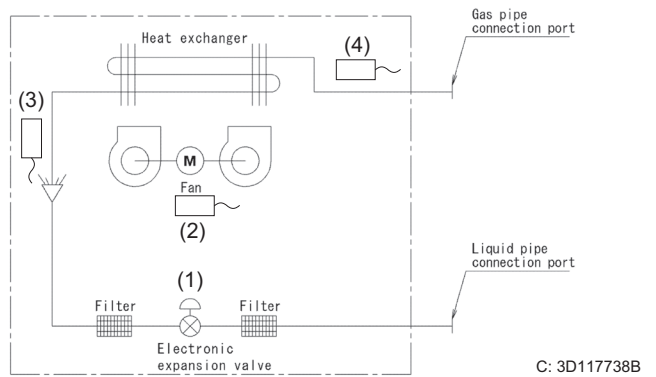

■ FXTQ-TA, FXTQ-TB

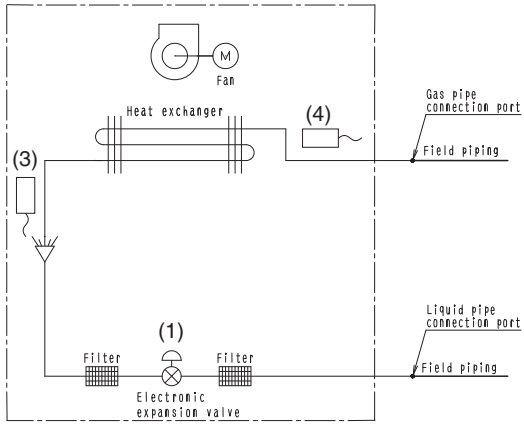

C: 4D068194

■ CXTQ-TA

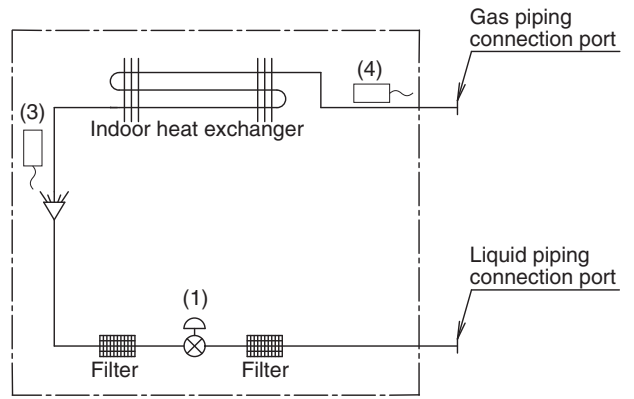

## 1.4 Outdoor-Air Processing Unit

FXMQ48/72/96MFVJU\*

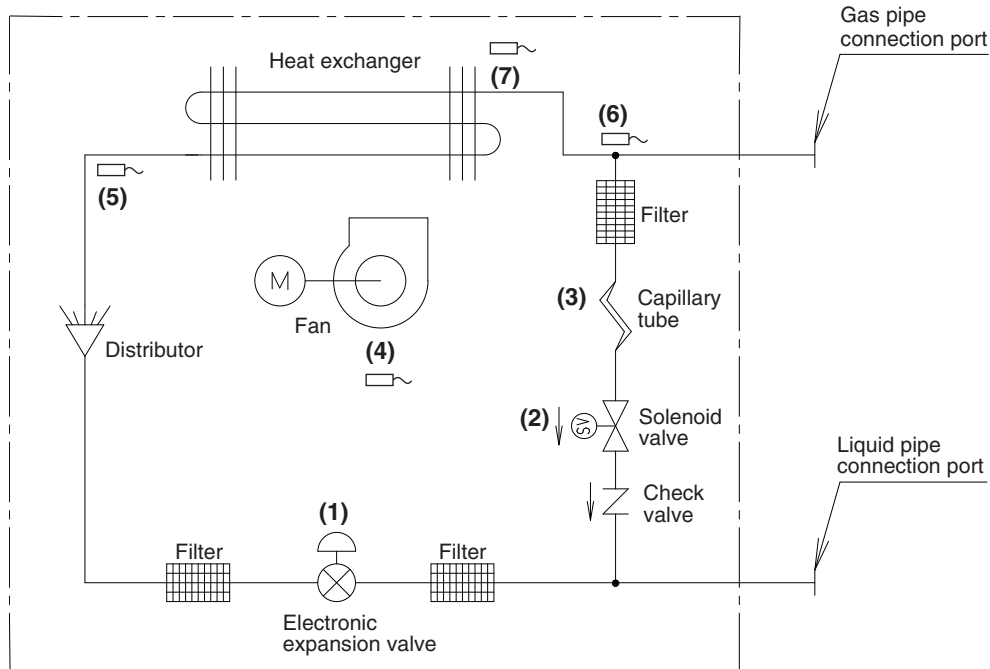

C: 4D018650D

No. in piping diagram	Electric symbol	Name	Function
(1)	Y1E	Electronic expansion valve	Used to control the flow rate of refrigerant, and make the SH control (*1) while in cooling.
(2)	Y1S	Solenoid valve	Used to bypass hot gas while in heating with thermostat OFF. Closed while in cooling.
(3)	—	Capillary tube	Used to reduce pressure from high to low in bypassing hot gas.
(4)	R1T	Suction air thermistor	Used to turn ON or OFF the thermostat.
(5)	R2T	Liquid pipe thermistor	Used to control the opening degree of electronic expansion valve under the SC control (*2).
(6)	R3T	Gas pipe thermistor	Used to control the opening degree of electronic expansion valve under the SH control.
(7)	R4T	Discharge air thermistor	Used to control the electronic expansion valve opening and thermostat ON/OFF so as to keep the discharge air temperature at the set temperature.



### Note(s)

\*1. SH control: Superheating control of heat exchanger outlet

\*2. SC control: Subcooling control of heat exchanger outlet

## 2. Functional Parts Layout

### 2.1 REYQ72AA

#### Plane View

Solenoid valve  
(Oil separator oil return 1)  
(Y1S)

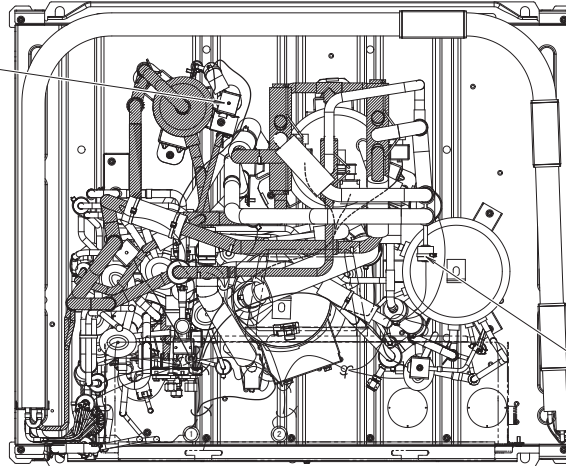

Low pressure sensor  
(S1NPL)

#### Front View

Four way valve  
(HP/LP gas pipe)  
(Y8S)

High pressure sensor  
(S1NPH)

High pressure switch (M1C)  
(S1PH)

Thermistor (Outdoor air)  
(R1T)

Thermistor (M1C body)  
(R18T)

Thermistor  
(M1C discharge pipe)  
(R17T)

A

Crankcase heater  
(E1HC)

Compressor  
(M1C)

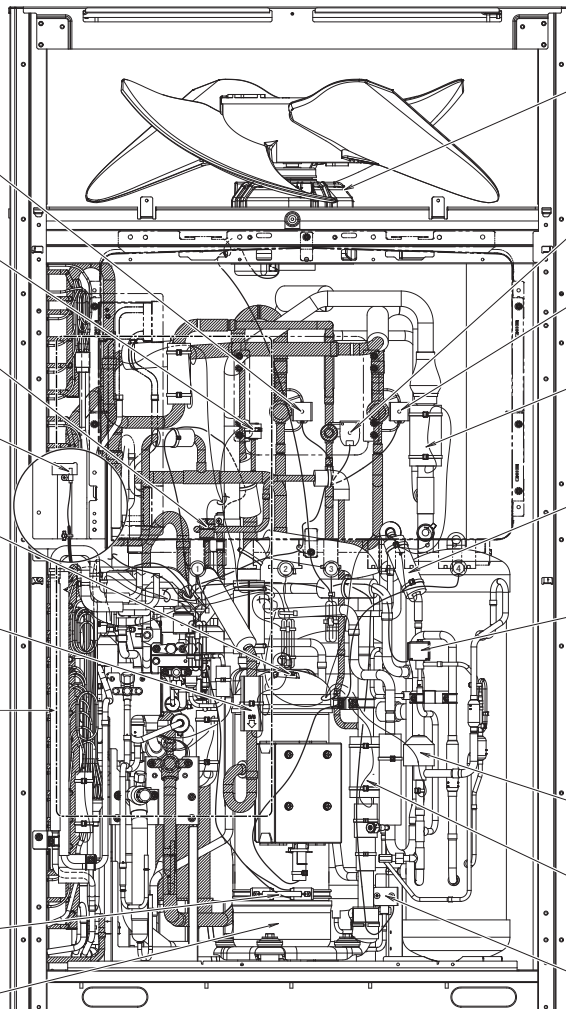

Fan motor  
(M1F)

Four way valve  
(Heat exchanger right upper)  
(Y10S)

Four way valve  
(Heat exchanger right lower)  
(Y7S)

Thermistor  
(Suction pipe before accumulator)  
(R5T)

Thermistor  
(Receiver gas purge)  
(R4T)

Solenoid valve  
(Refrigerant adjustment)  
(Y5S)

Electronic expansion valve  
(Receiver gas purge)  
(Y4E)

Thermistor  
(Compressor suction)  
(R19T)

Solenoid valve  
(Accumulator oil return)  
(Y4S)

C: 0P655111N

Detail of A

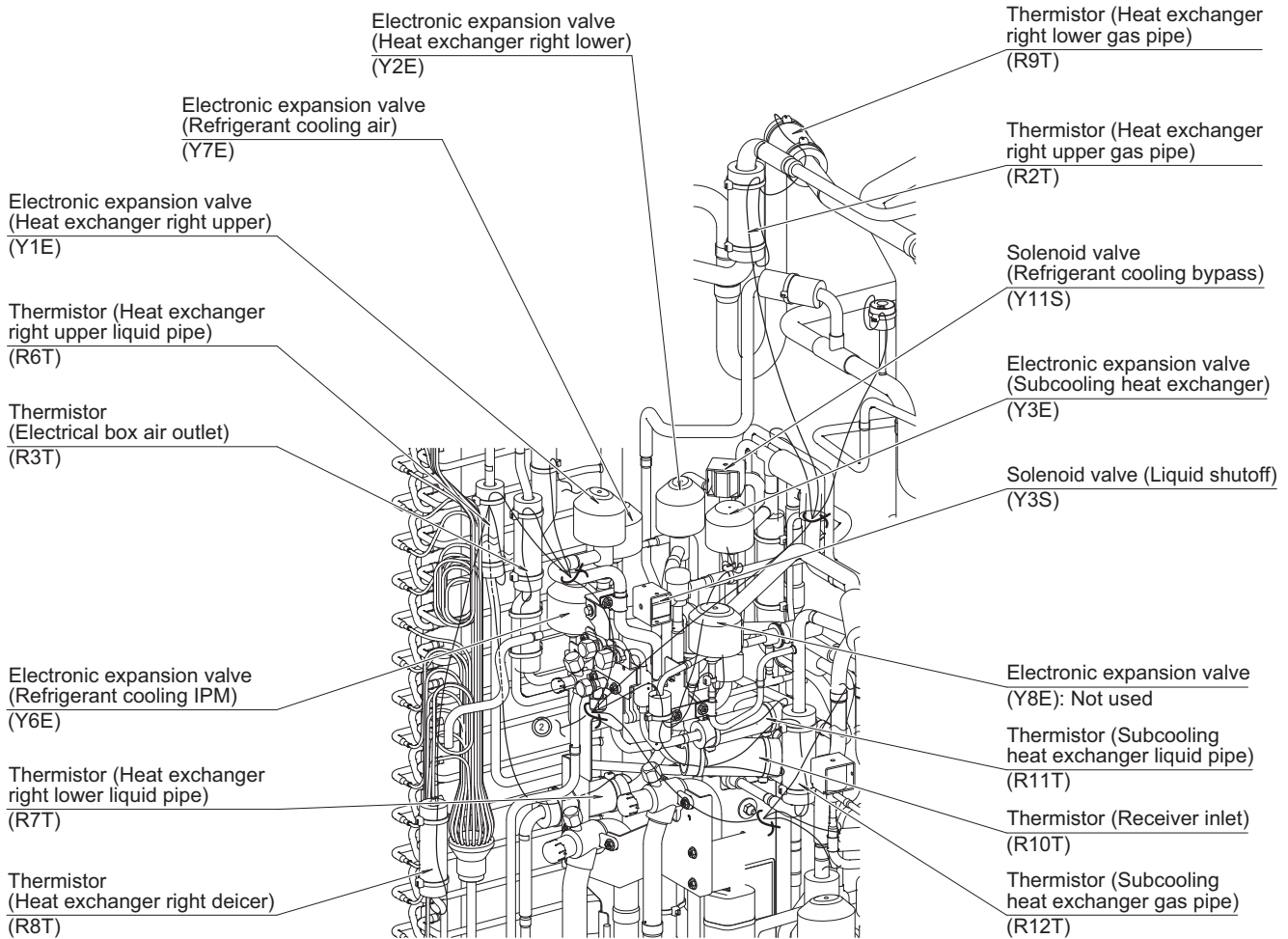

C: 0P65511N

Inside Electrical Component Box

REYQ72AATJ\*

Thermistor (Box air)  
(R20T)

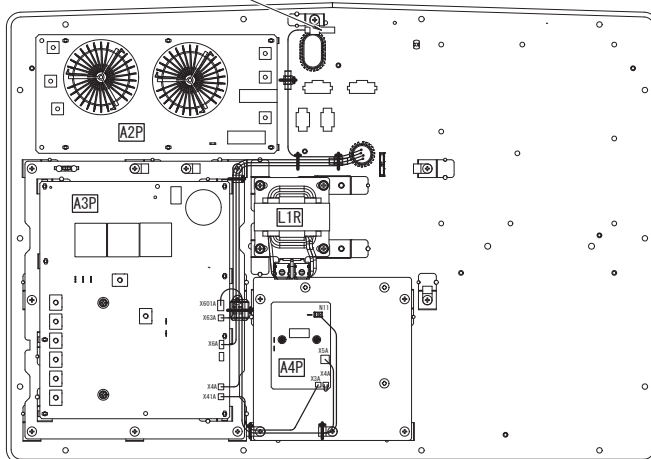

C: 1P645891J

REYQ72AAVD\*

Thermistor (Box air)  
(R20T)

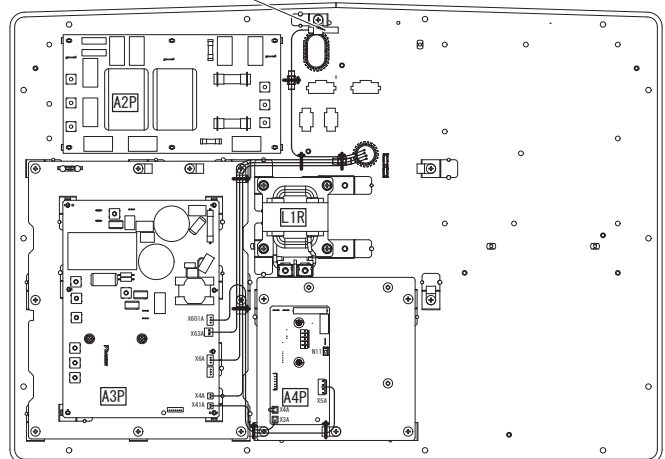

C: 1P647828H



## 2.2 REYQ96/120AA

### Plane View

Solenoid valve  
(Oil separator oil return 2)  
(Y1S)

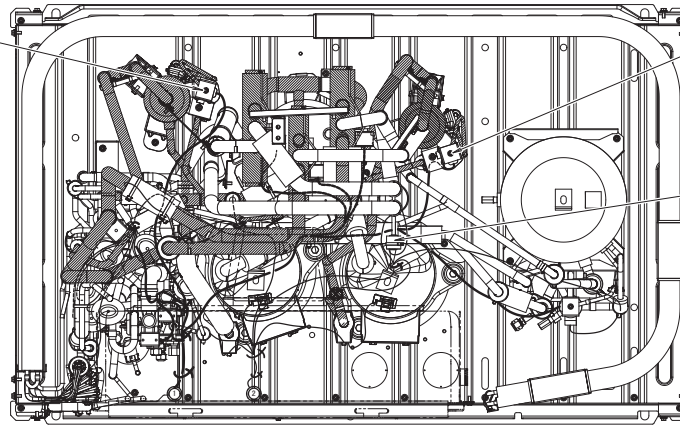

Solenoid valve  
(Oil separator oil return 1)  
(Y2S)

Low pressure sensor  
(S1NPL)

### Front View

Fan motor 2  
(M2F)

Four way valve  
(Heat exchanger right upper)  
(Y10S)

Four way valve  
(HP/LP gas pipe)  
(Y8S)

High pressure sensor  
(S1NPH)

High pressure switch (M2C)  
(S2PH)

Thermistor (Outdoor air)  
(R1T)

Thermistor (M2C body)  
(R18T)

Thermistor  
(M2C discharge pipe)  
(R17T)

Solenoid valve  
(Accumulator oil return)  
(Y4S)

Crankcase heater  
(E2HC)

Compressor 2  
(M2C)

A

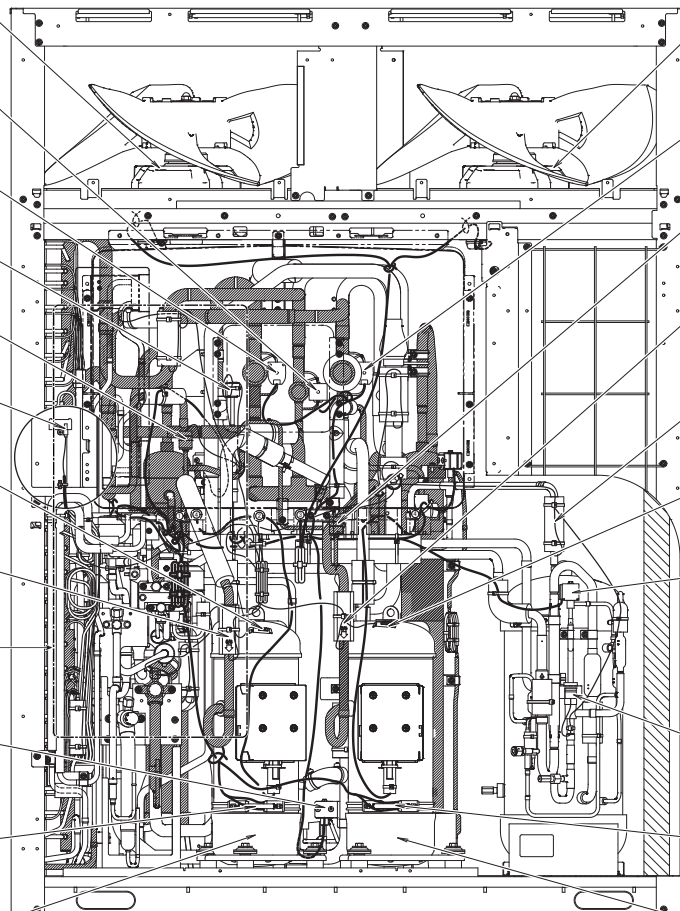

Fan motor 1  
(M1F)

Four way valve  
(Heat exchanger right lower)  
(Y7S)

High pressure switch (M1C)  
(S1PH)

Thermistor  
(M1C discharge pipe)  
(R15T)

Thermistor  
(Receiver gas purge)  
(R4T)

Thermistor (M1C body)  
(R16T)

Solenoid valve  
(Refrigerant adjustment)  
(Y5S)

Electronic expansion valve  
(Receiver gas purge)  
(Y4E)

Crankcase heater  
(E1HC)

Compressor 1  
(M1C)

C: 0P655113M



**Detail of A**

Thermistor (Heat exchanger right upper gas pipe)  
(R2T)

Thermistor (Electrical box air outlet)  
(R3T)

Thermistor (Heat exchanger right upper liquid pipe)  
(R6T)

Electronic expansion valve (Y8E): Not used

Thermistor (Heat exchanger right lower liquid pipe)  
(R7T)

Thermistor (Heat exchanger right deicer)  
(R8T)

Thermistor (Receiver inlet)  
(R10T)

Thermistor (Heat exchanger right lower gas pipe)  
(R9T)

Thermistor (Suction pipe before accumulator)  
(R5T)

Thermistor (Subcooling heat exchanger liquid pipe)  
(R11T)

Thermistor (Subcooling heat exchanger gas pipe)  
(R12T)

Thermistor (Compressor suction)  
(R19T)

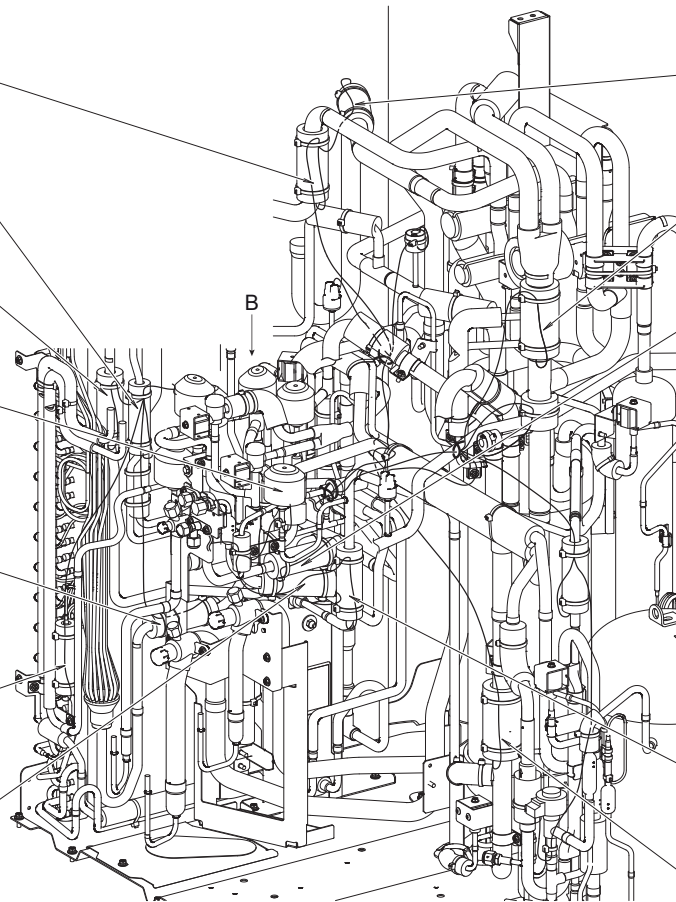

**Detail of B**

Solenoid valve (Refrigerant cooling bypass)  
(Y11S)

Electronic expansion valve (Heat exchanger right lower)  
(Y2E)

Electronic expansion valve (Refrigerant cooling air)  
(Y7E)

Electronic expansion valve (Heat exchanger right upper)  
(Y1E)

Electronic expansion valve (Refrigerant cooling IPM)  
(Y6E)

Electronic expansion valve (Subcooling heat exchanger)  
(Y3E)

Solenoid valve (Liquid shutoff)  
(Y3S)

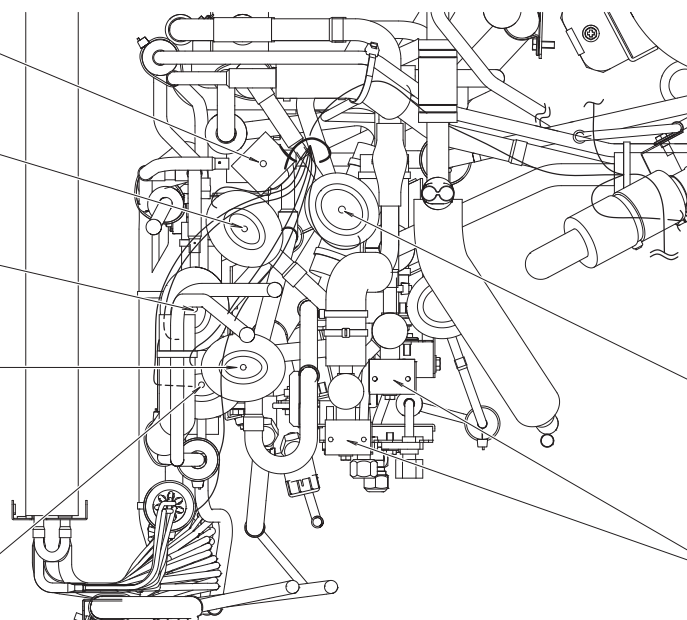

C: 0P655113M

Inside Electrical Component Box

REYQ96/120AATJ\*

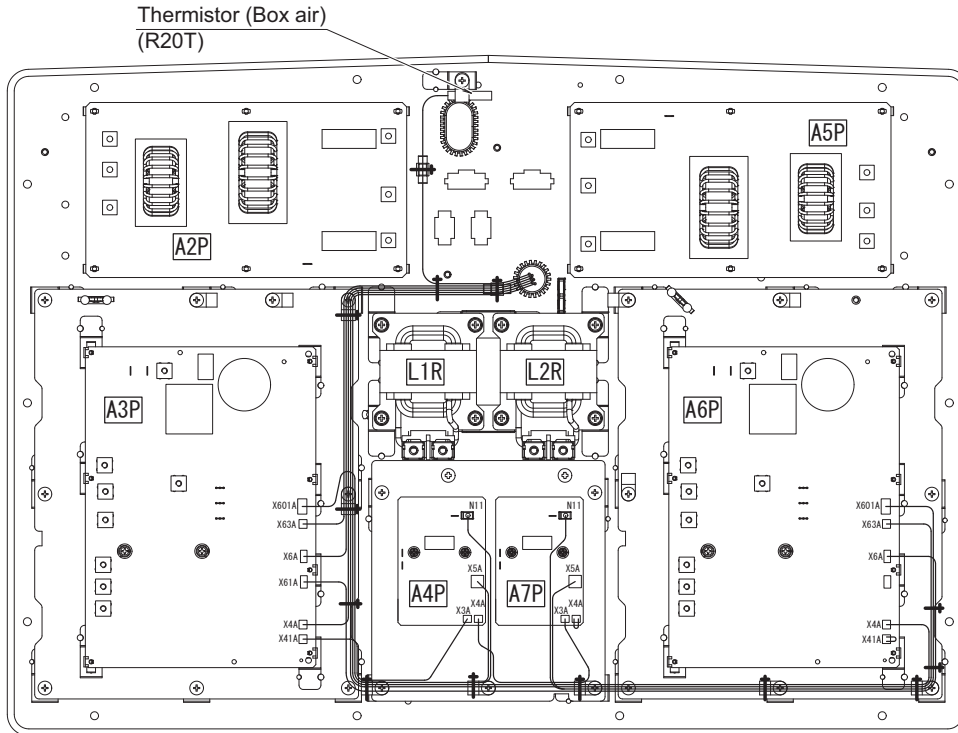

C: 1P645890H

REYQ96/120AAYD\*

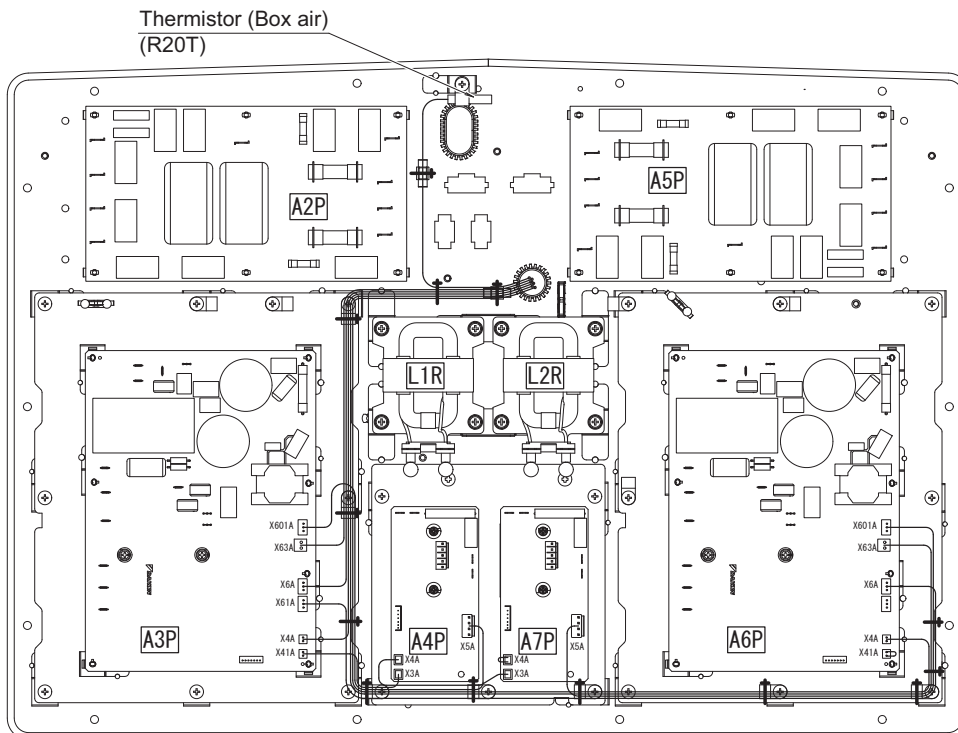

C: 1P647827H

## 2.3 REYQ144/168AA

### Plane View

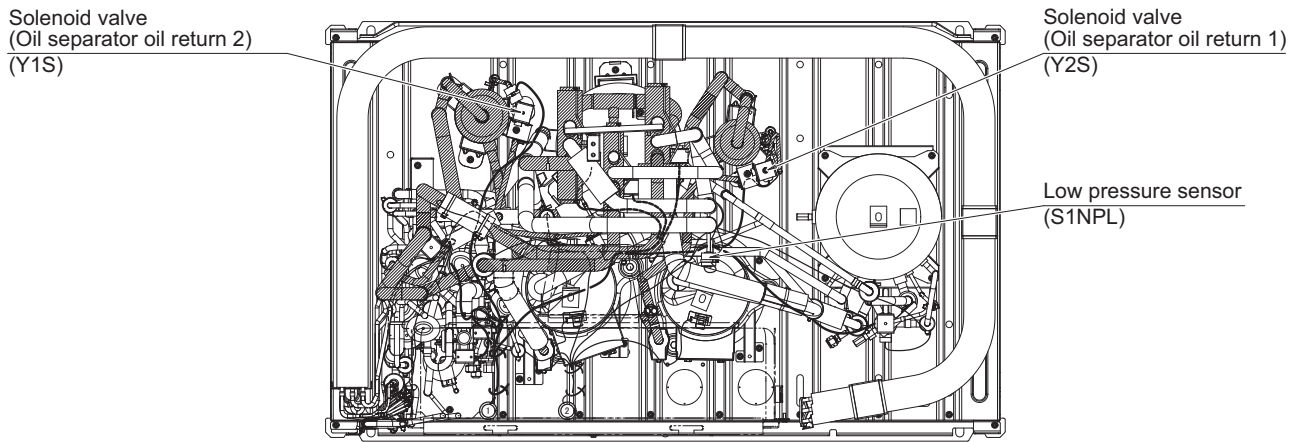

### Front View

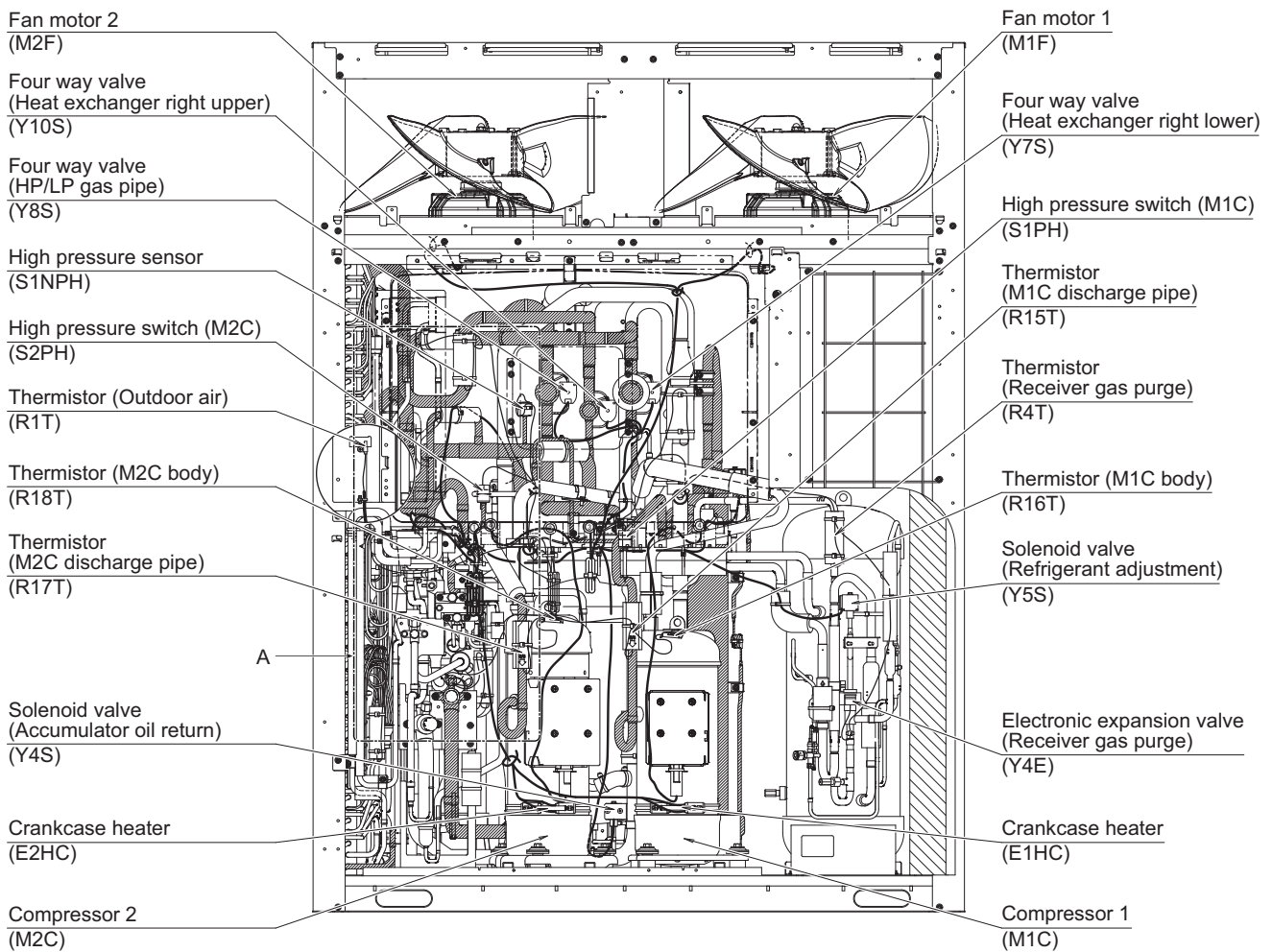

C: 0P655114G

**Detail of A**

Thermistor (Heat exchanger right upper gas pipe)  
(R2T)

Thermistor (Electrical box air outlet)  
(R3T)

Thermistor (Heat exchanger right upper liquid pipe)  
(R6T)

Electronic expansion valve (Y8E): Not used

Thermistor (Heat exchanger right lower liquid pipe)  
(R7T)

Thermistor (Heat exchanger right deicer)  
(R8T)

Thermistor (Receiver inlet)  
(R10T)

Thermistor (Heat exchanger right lower gas pipe)  
(R9T)

Thermistor (Suction pipe before accumulator)  
(R5T)

Thermistor (Subcooling heat exchanger liquid pipe)  
(R11T)

Thermistor (Subcooling heat exchanger gas pipe)  
(R12T)

Thermistor (Compressor suction)  
(R19T)

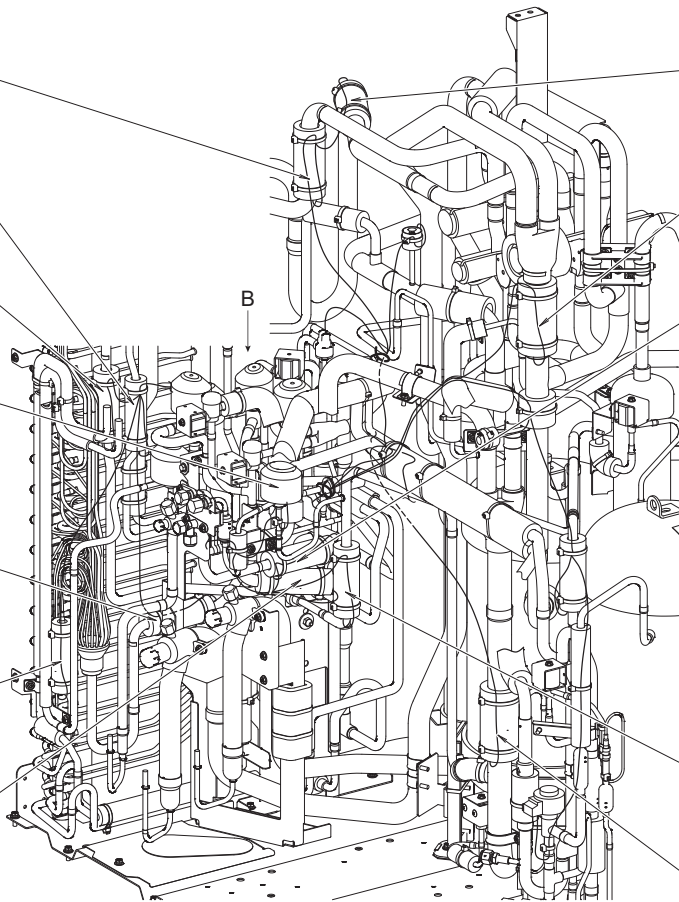

**Detail of B**

Solenoid valve (Refrigerant cooling bypass)  
(Y11S)

Electronic expansion valve (Heat exchanger right lower)  
(Y2E)

Electronic expansion valve (Refrigerant cooling air)  
(Y7E)

Electronic expansion valve (Heat exchanger right upper)  
(Y1E)

Electronic expansion valve (Refrigerant cooling IPM)  
(Y6E)

Electronic expansion valve (Subcooling heat exchanger)  
(Y3E)

Solenoid valve (Liquid shutoff)  
(Y3S)

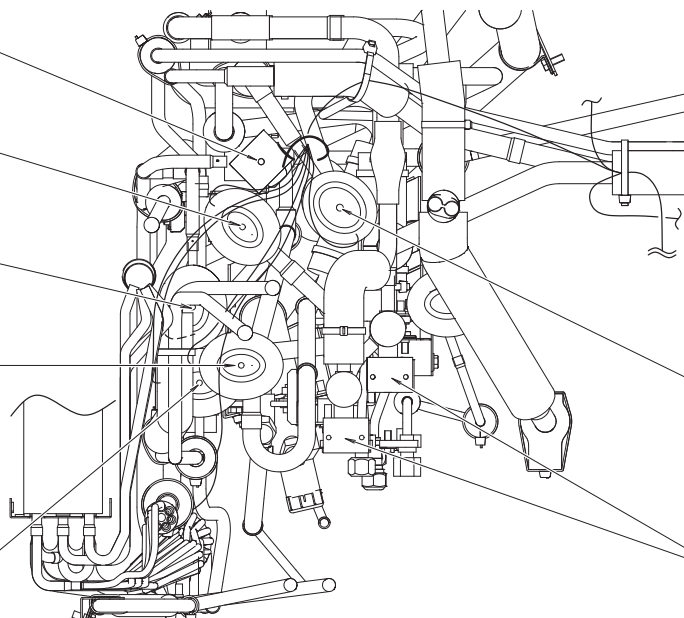

C: 0P655114G

### Inside Electrical Component Box

REYQ144/168AATJ\*

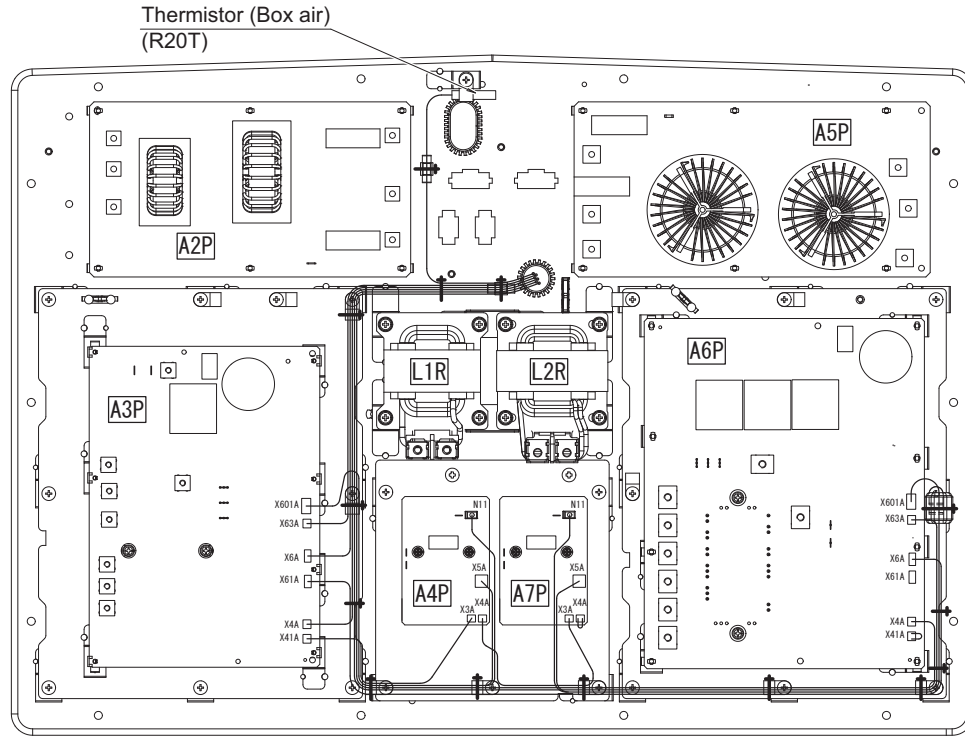

C: 1P645889G

REYQ144/168AAD\*

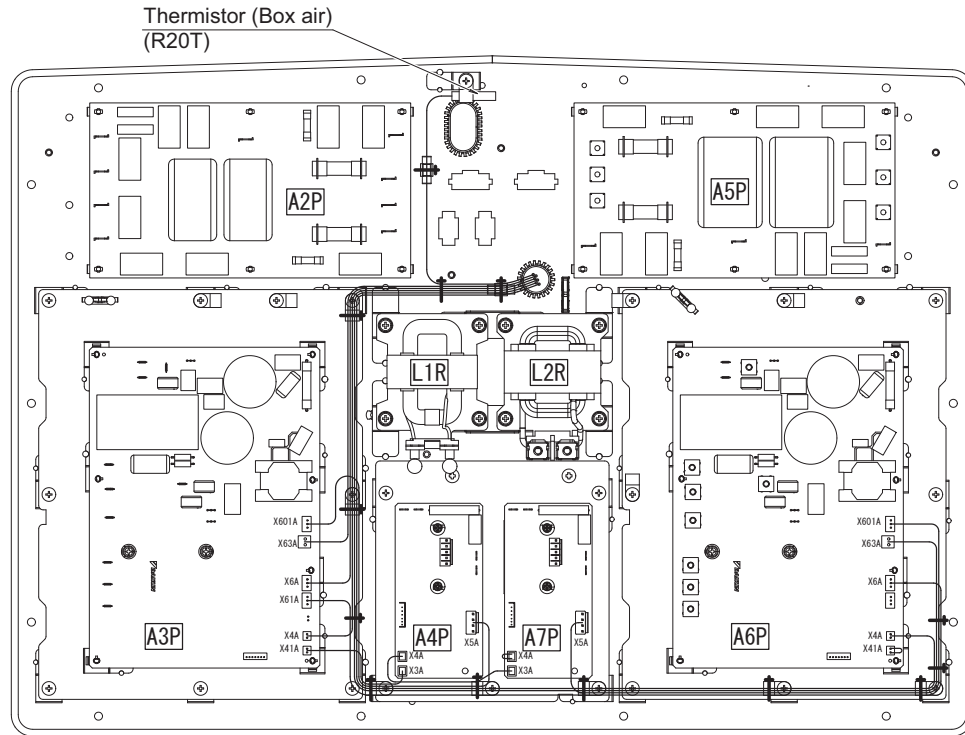

C: 1P647825H



## 2.4 REYQ192/216/240AA

### Plane View

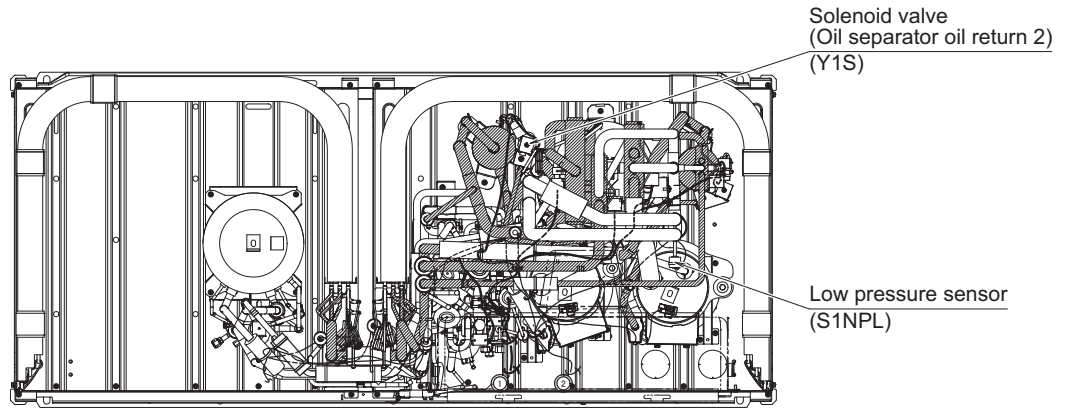

### Front View

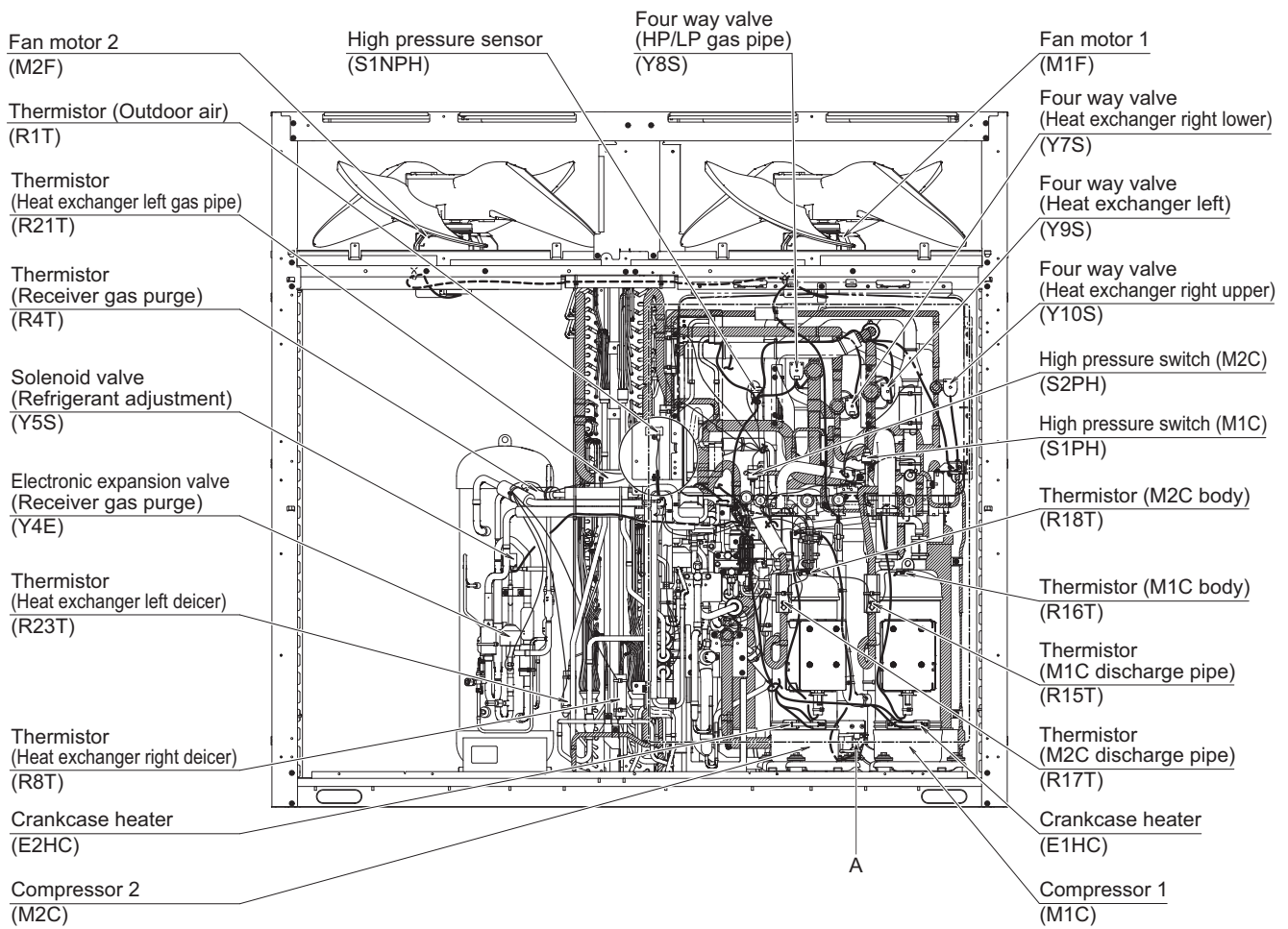

C: 0P648694M

**Detail of A**

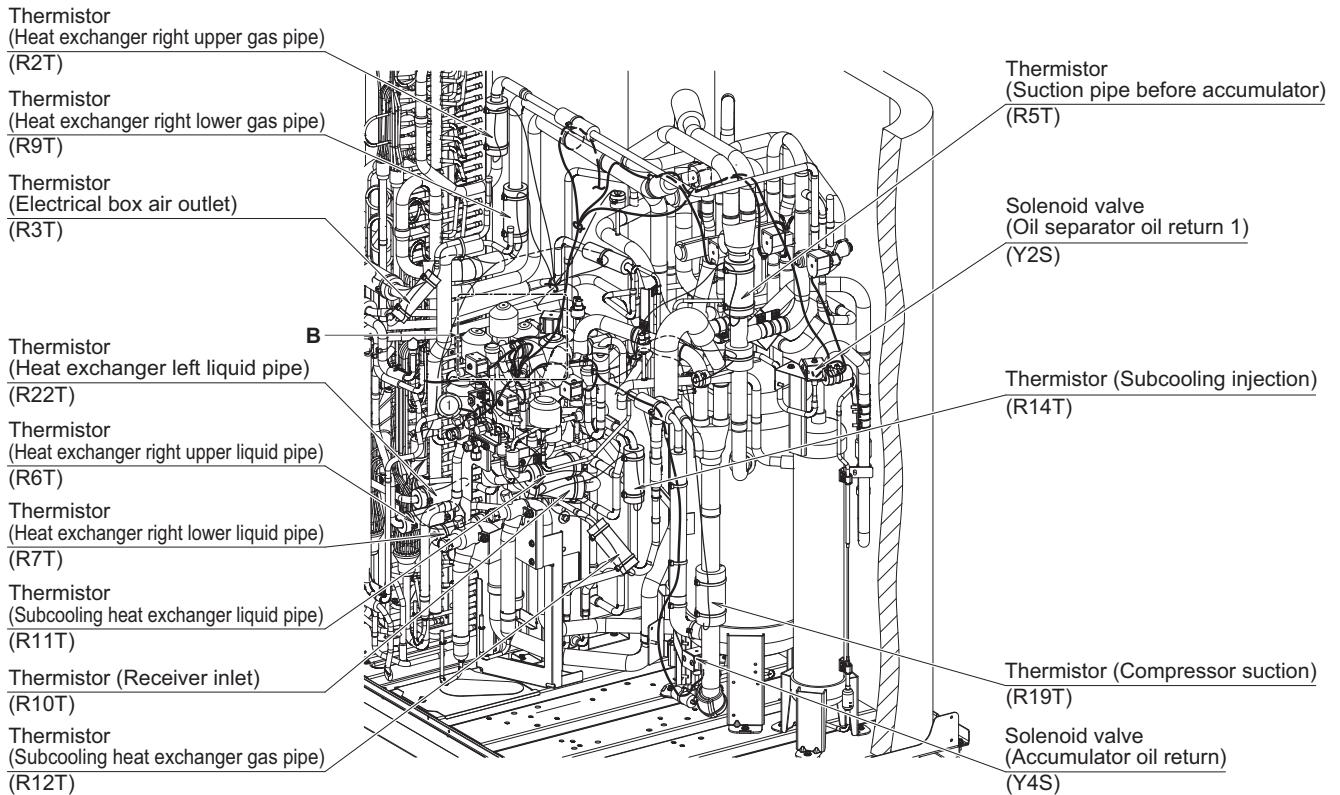

**Detail of B**

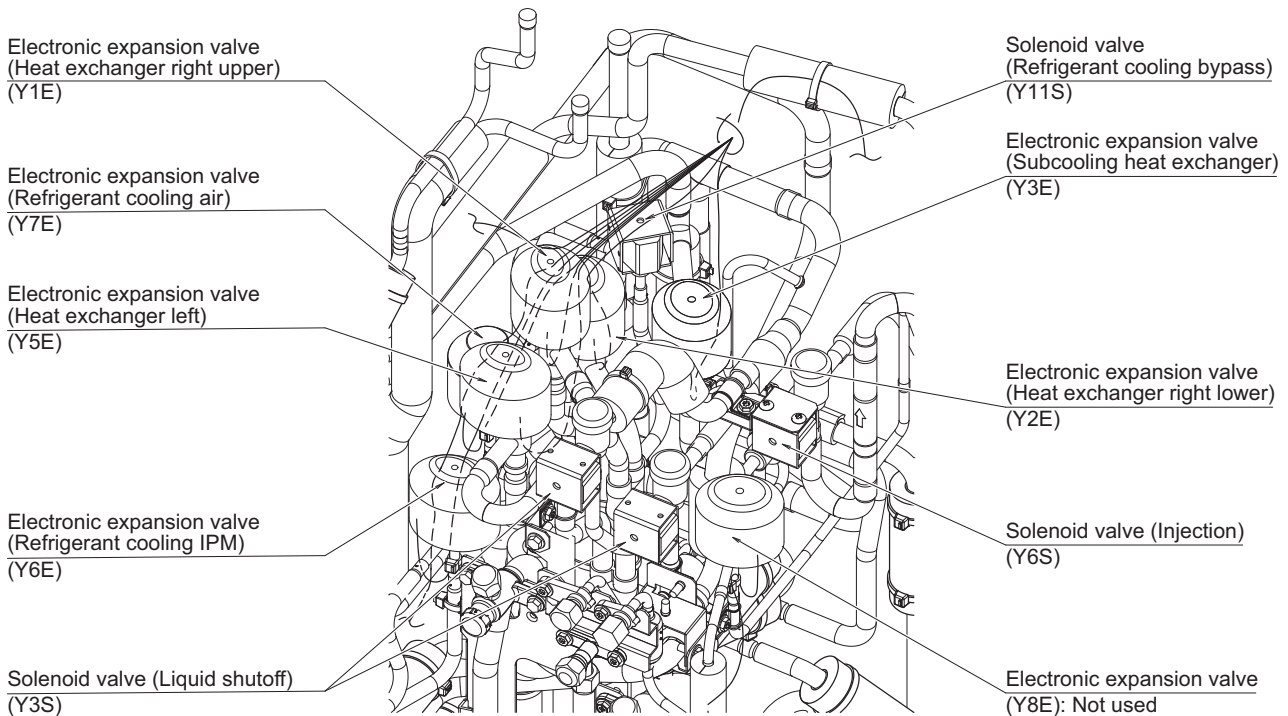

C: 0P648694M

Inside Electrical Component Box

REYQ192/216/240AATJ\*

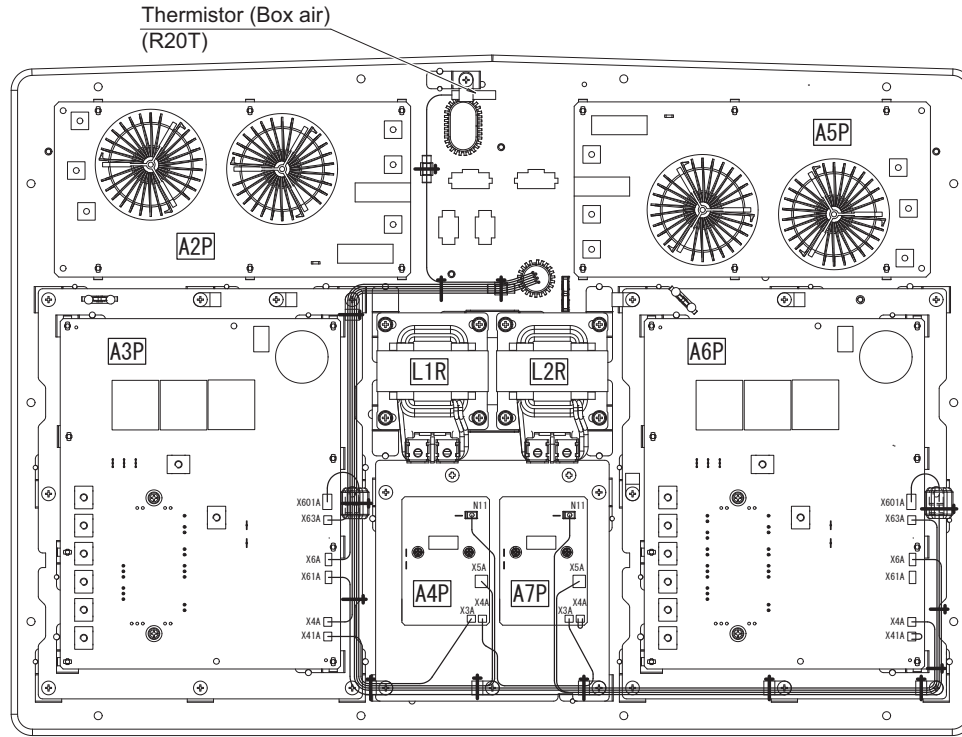

C: 1P645889G

REYQ192/216/240AAJD\*

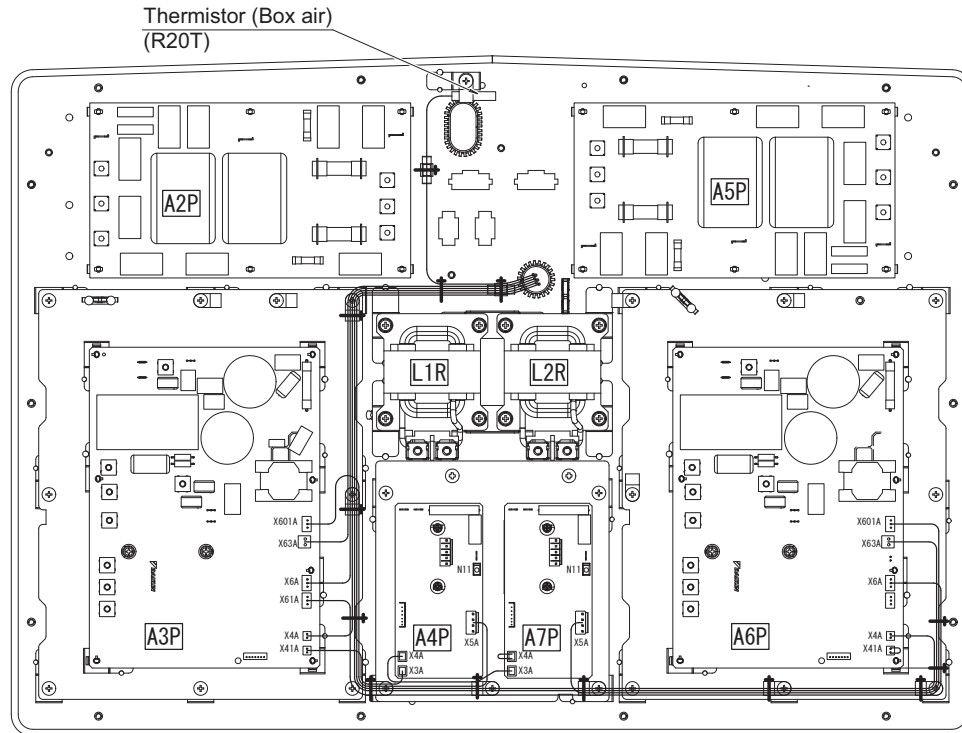

C: 1P647825H



# 3. Refrigerant Flow for Each Operation Mode

## 3.1 REYQ72AA

### Cooling Operation

- High temperature, high pressure gas
- High temperature, high pressure liquid
- Low temperature, low pressure gas
- Low temperature, low pressure liquid

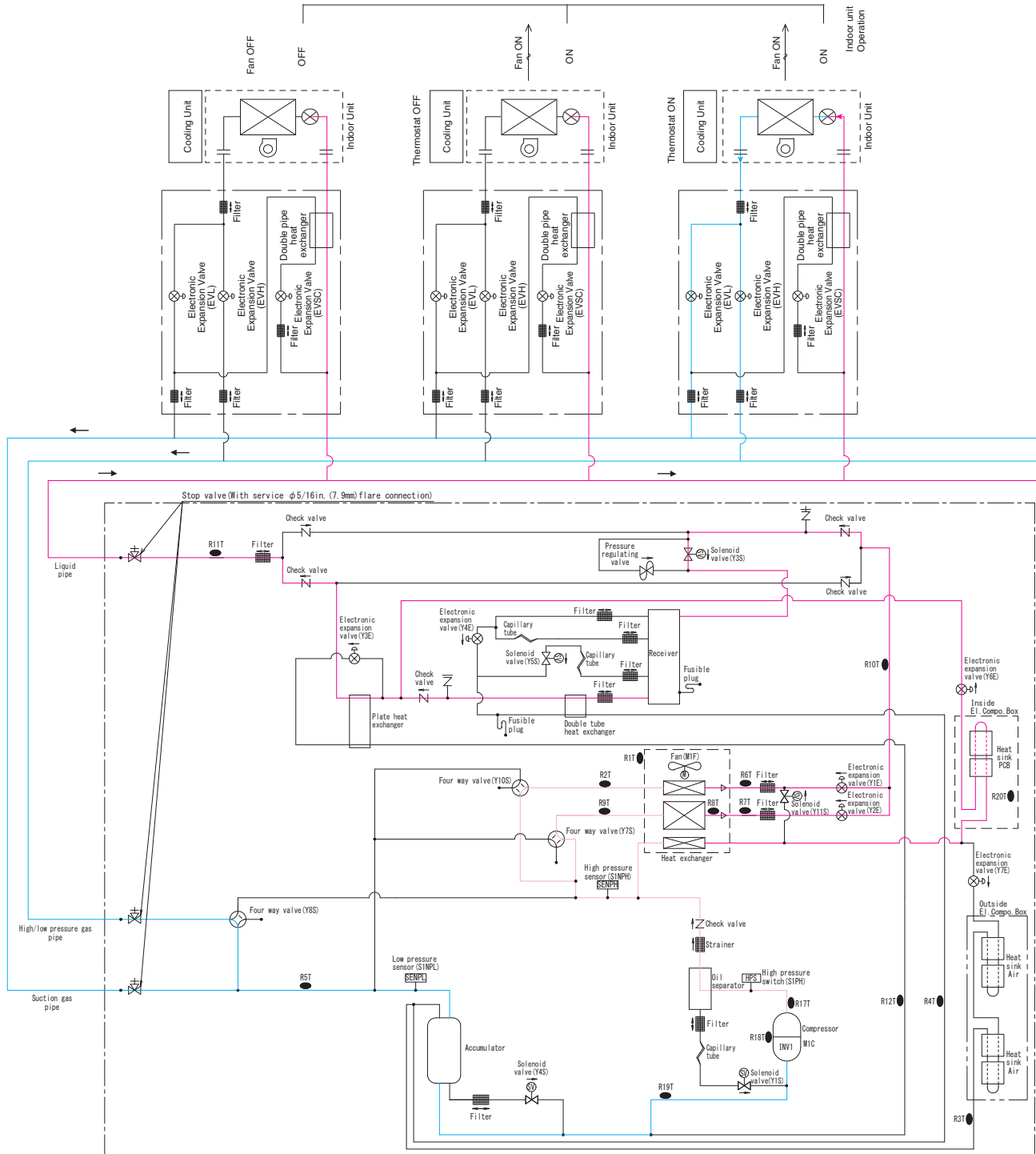

C: 3D135725B

Heating Operation

- High temperature, high pressure gas
- High temperature, high pressure liquid
- Low temperature, low pressure gas
- Low temperature, low pressure liquid

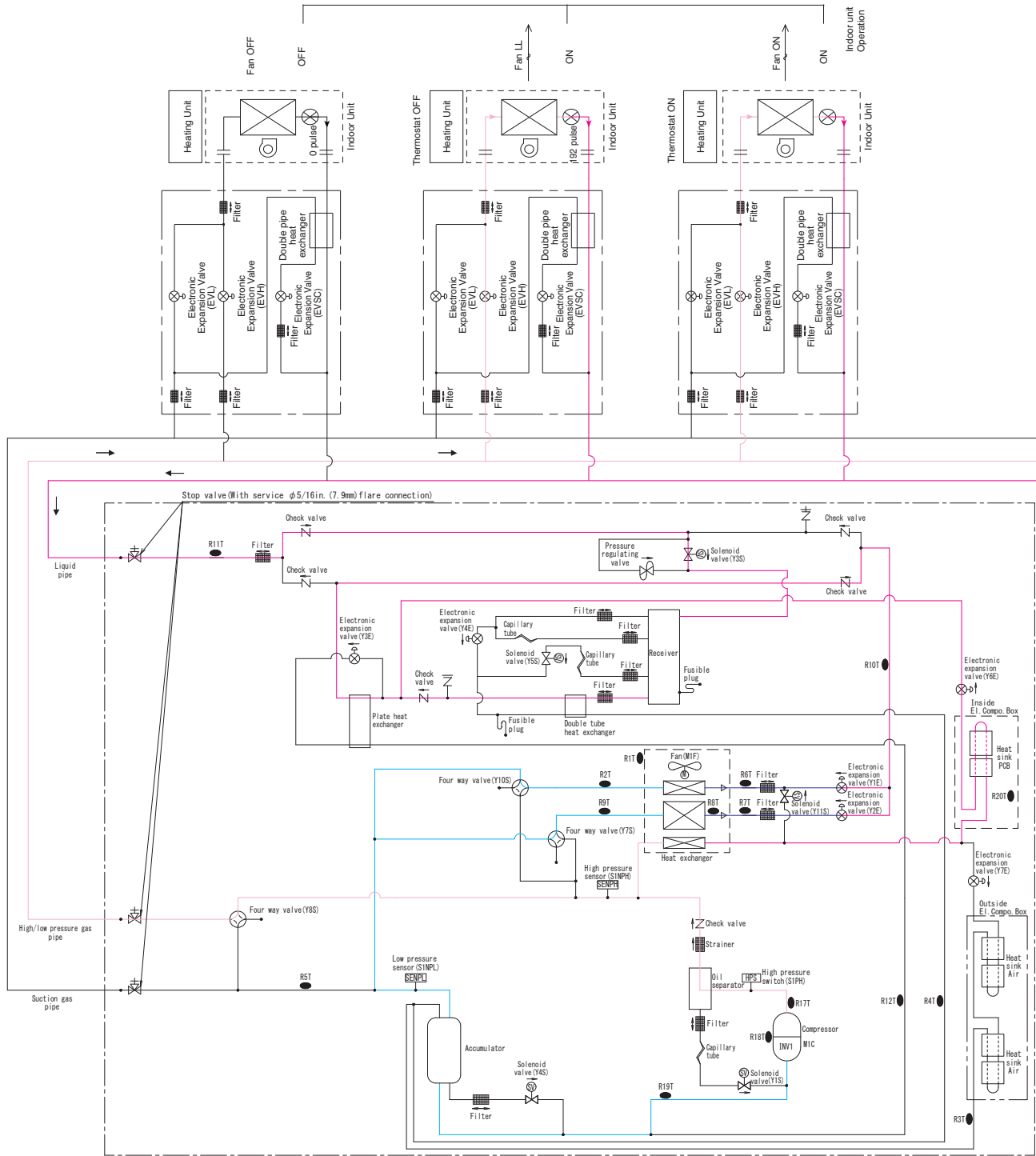

C: 3D135725B

Simultaneous Cooling and Heating Operation

- High temperature, high pressure gas
- High temperature, high pressure liquid
- Low temperature, low pressure gas
- Low temperature, low pressure liquid

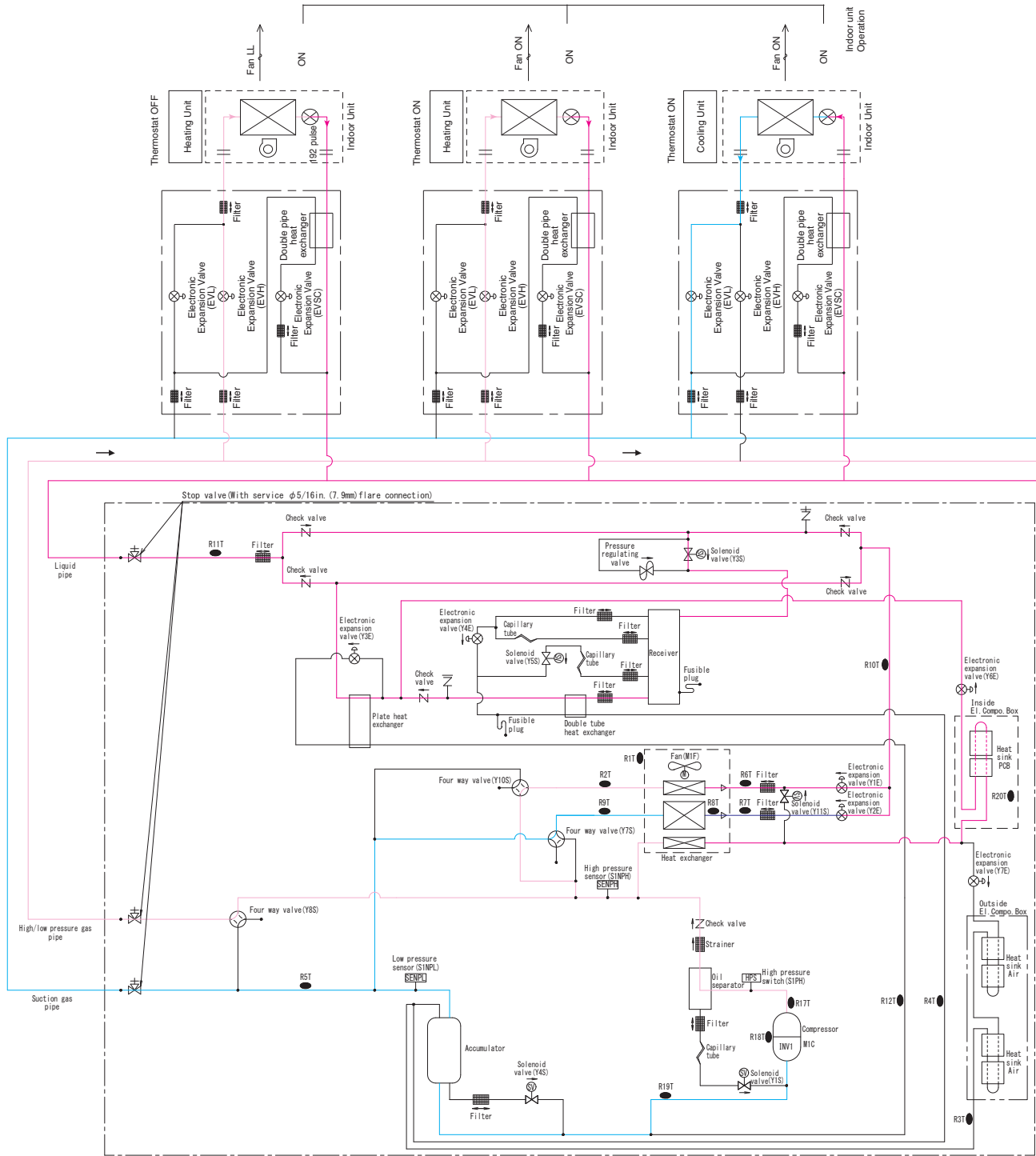

C: 3D135725B

Cooling Oil Return Operation

- High temperature, high pressure gas
- High temperature, high pressure liquid
- Low temperature, low pressure gas
- Low temperature, low pressure liquid

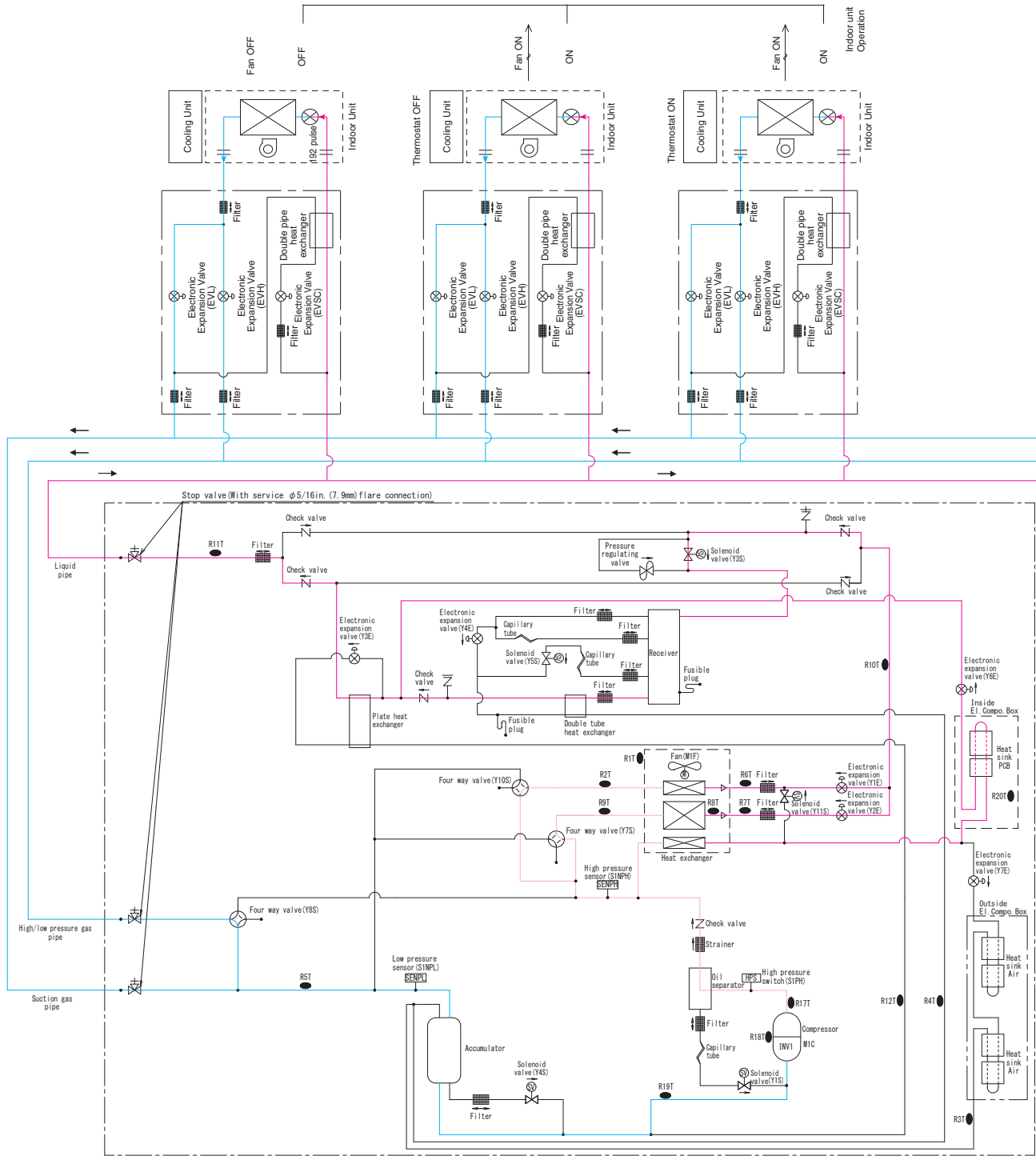

C: 3D135725B

### Defrost Heating Oil Return Operation

- High temperature, high pressure gas
- High temperature, high pressure liquid
- Low temperature, low pressure gas
- Low temperature, low pressure liquid

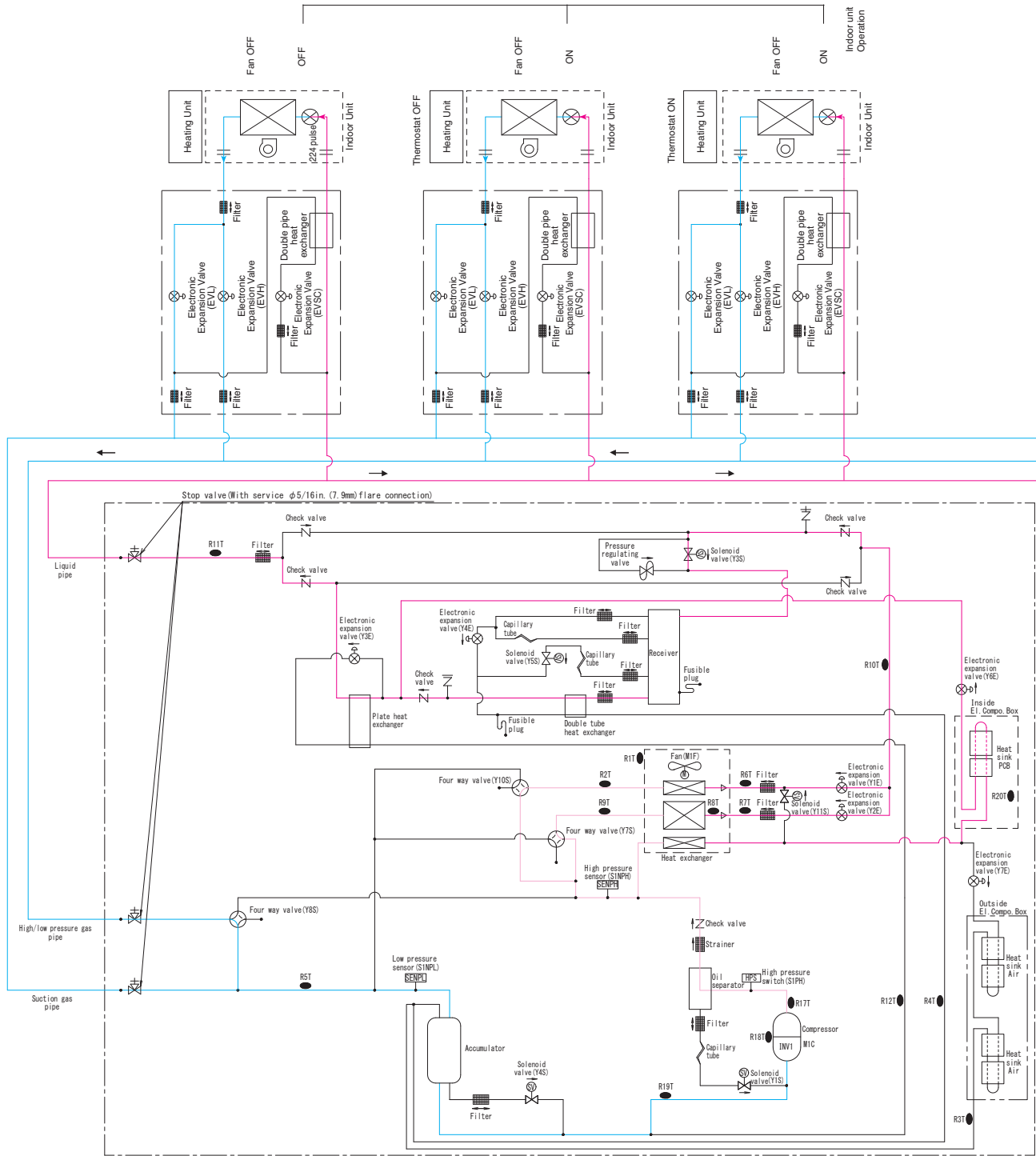

C: 3D135725B

Oil Return Operation at Simultaneous Cooling and Heating Operation

- High temperature, high pressure gas
- High temperature, high pressure liquid
- Low temperature, low pressure gas
- Low temperature, low pressure liquid

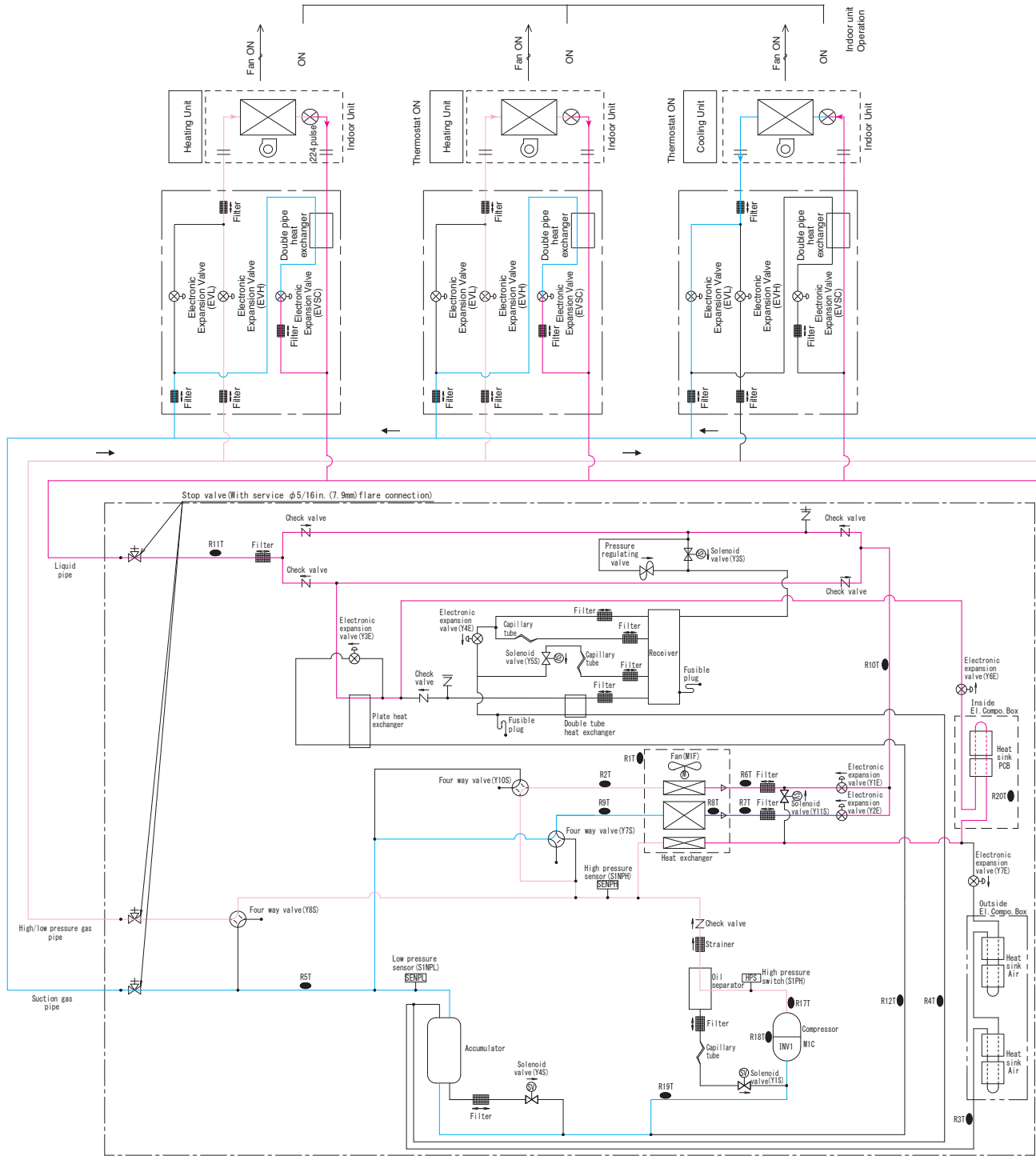

C: 3D135725B

# 3.2 REYQ96/120/144/168AA

## Cooling Operation

- High temperature, high pressure gas
- High temperature, high pressure liquid
- Low temperature, low pressure gas
- Low temperature, low pressure liquid

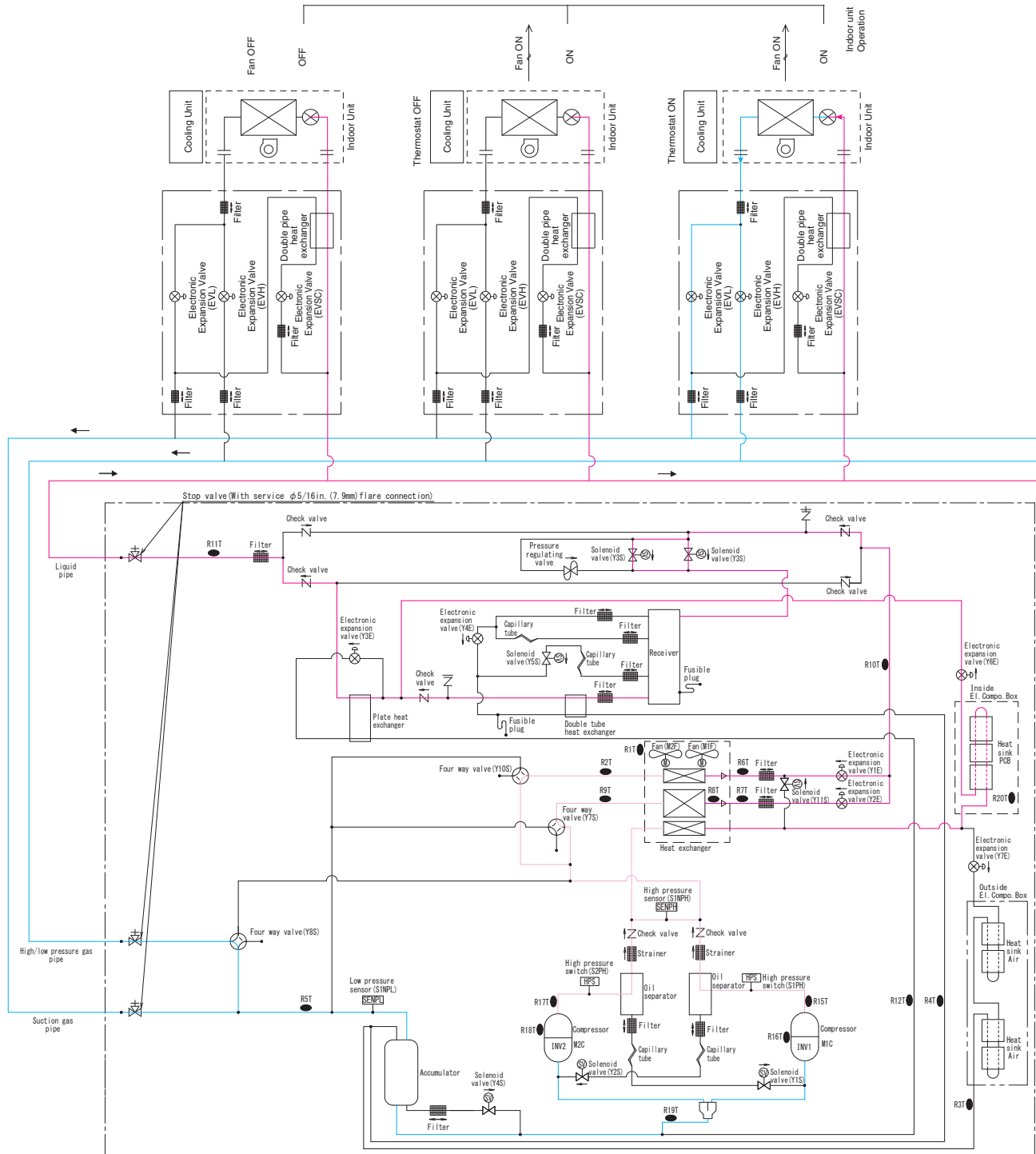

C: 3D135726C

Heating Operation

- High temperature, high pressure gas
- High temperature, high pressure liquid
- Low temperature, low pressure gas
- Low temperature, low pressure liquid

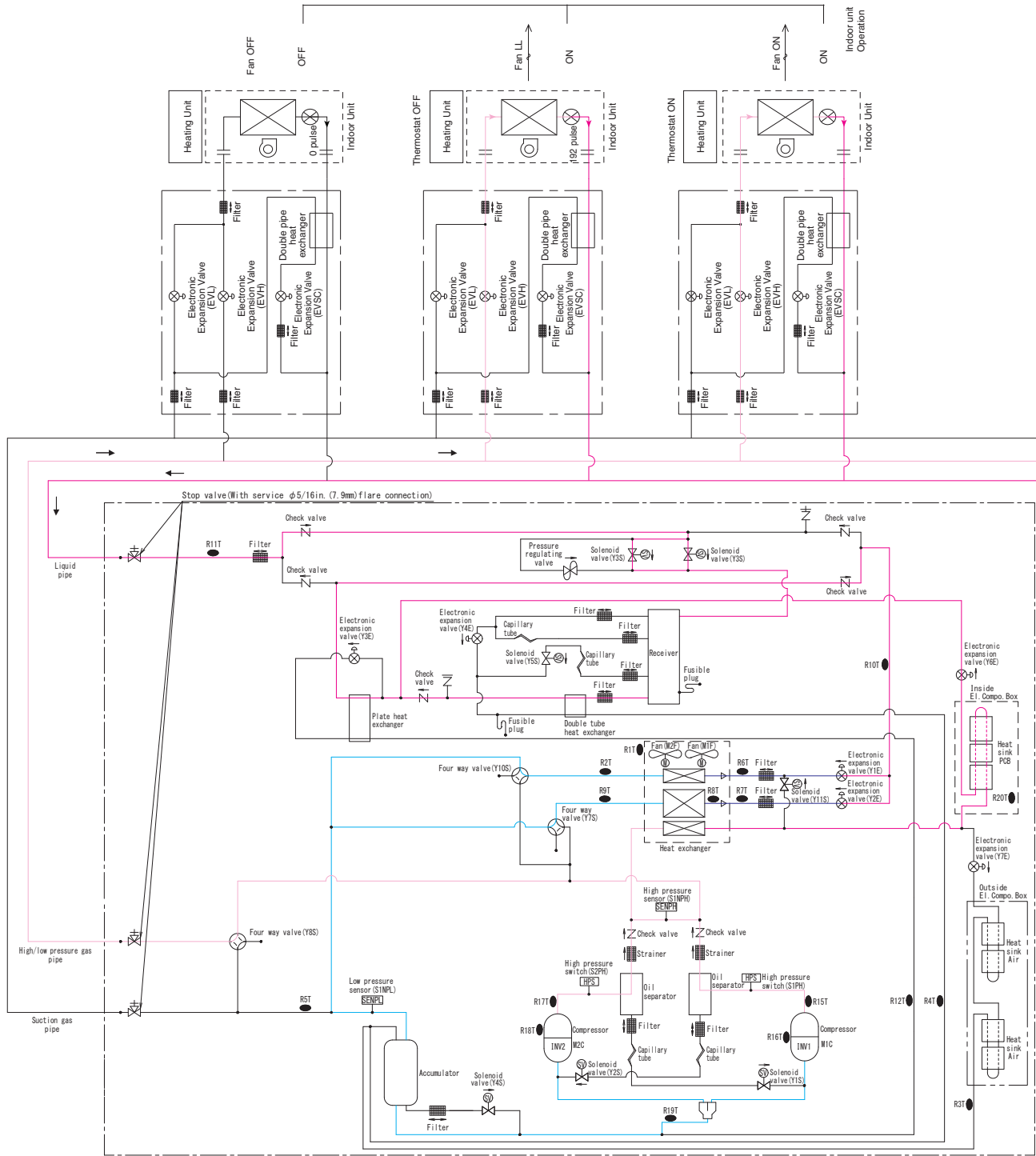

C: 3D135726C



Simultaneous Cooling and Heating Operation

- High temperature, high pressure gas
- High temperature, high pressure liquid
- Low temperature, low pressure gas
- Low temperature, low pressure liquid

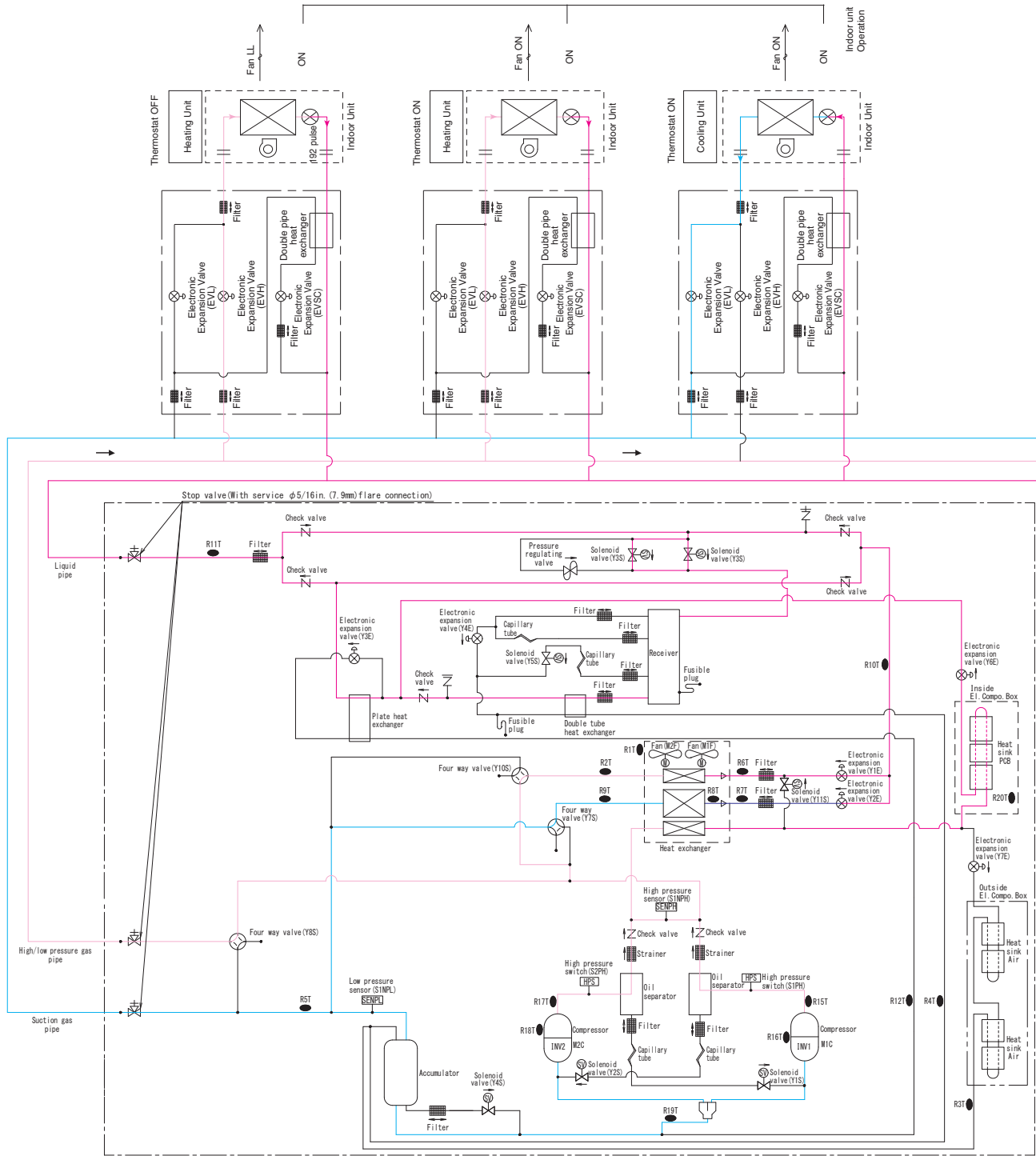

C: 3D135726C

Cooling Oil Return Operation

- High temperature, high pressure gas
- High temperature, high pressure liquid
- Low temperature, low pressure gas
- Low temperature, low pressure liquid

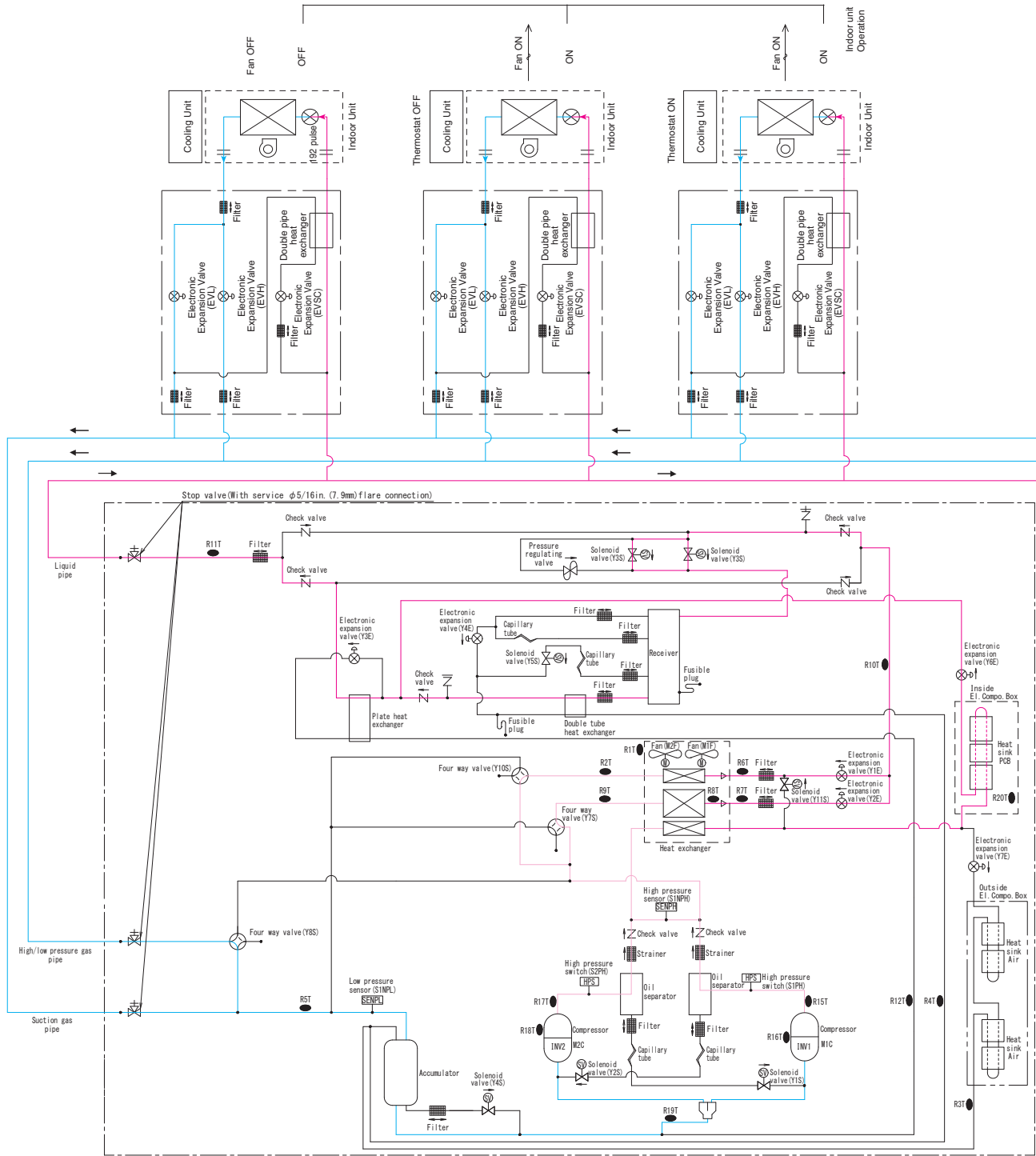

C: 3D135726C

### Defrost Heating Oil Return Operation

- High temperature, high pressure gas
- High temperature, high pressure liquid
- Low temperature, low pressure gas
- Low temperature, low pressure liquid

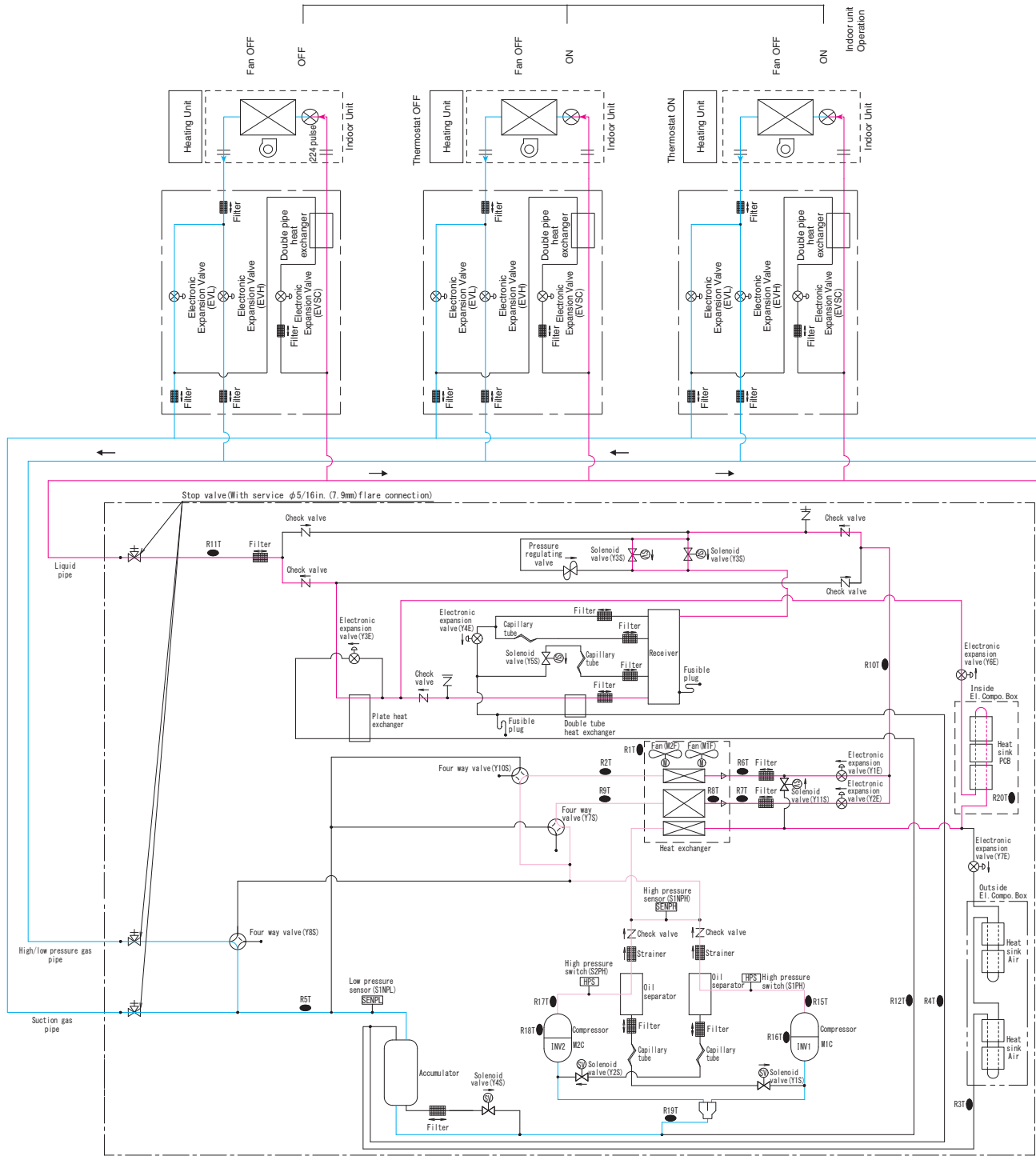

C: 3D135726C

Oil Return Operation at Simultaneous Cooling and Heating Operation

- High temperature, high pressure gas
- High temperature, high pressure liquid
- Low temperature, low pressure gas
- Low temperature, low pressure liquid

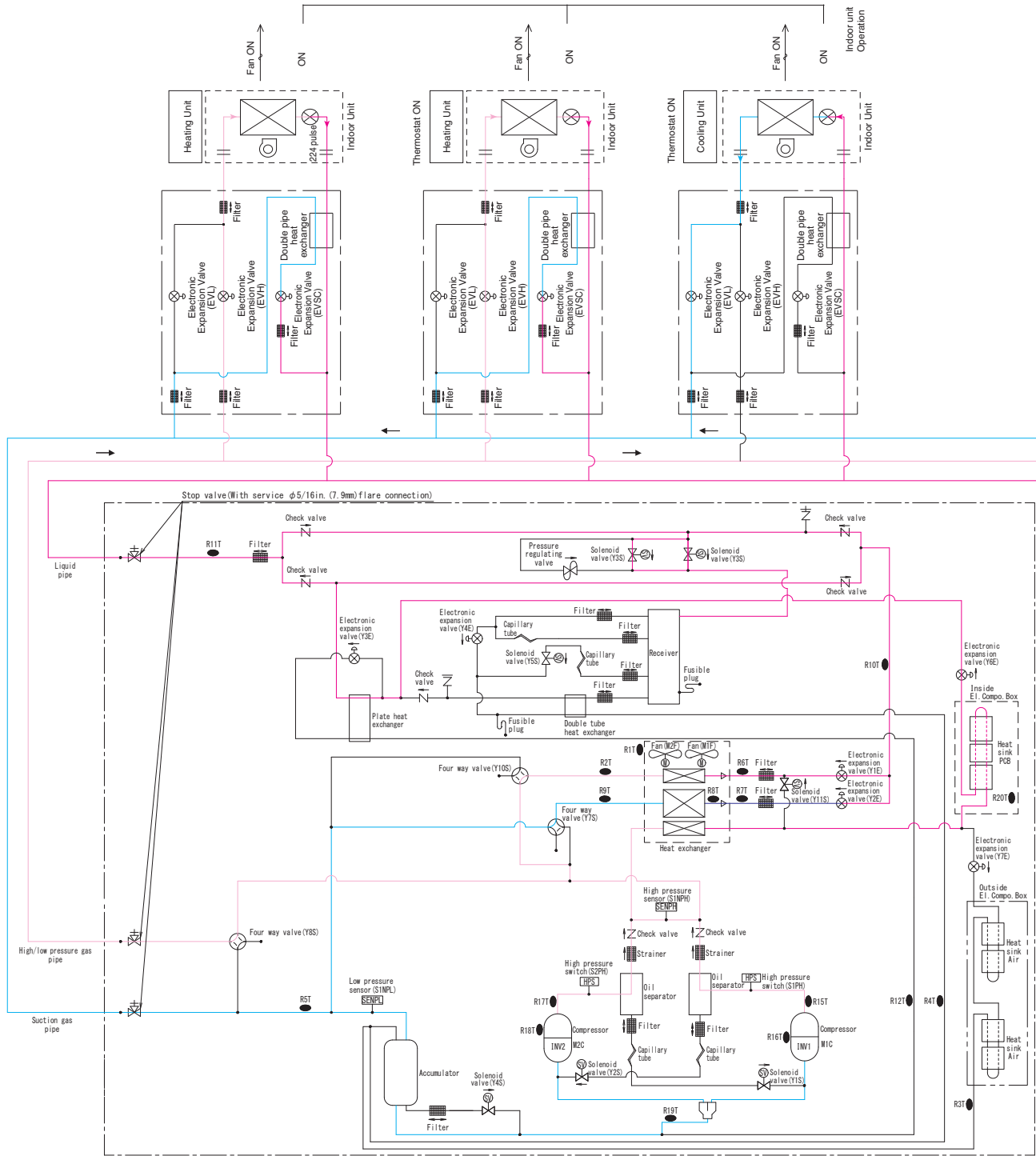

C: 3D135726C

### 3.3 REYQ192/216/240AA

#### Cooling Operation

- High temperature, high pressure gas
- High temperature, high pressure liquid
- Low temperature, low pressure gas
- Low temperature, low pressure liquid

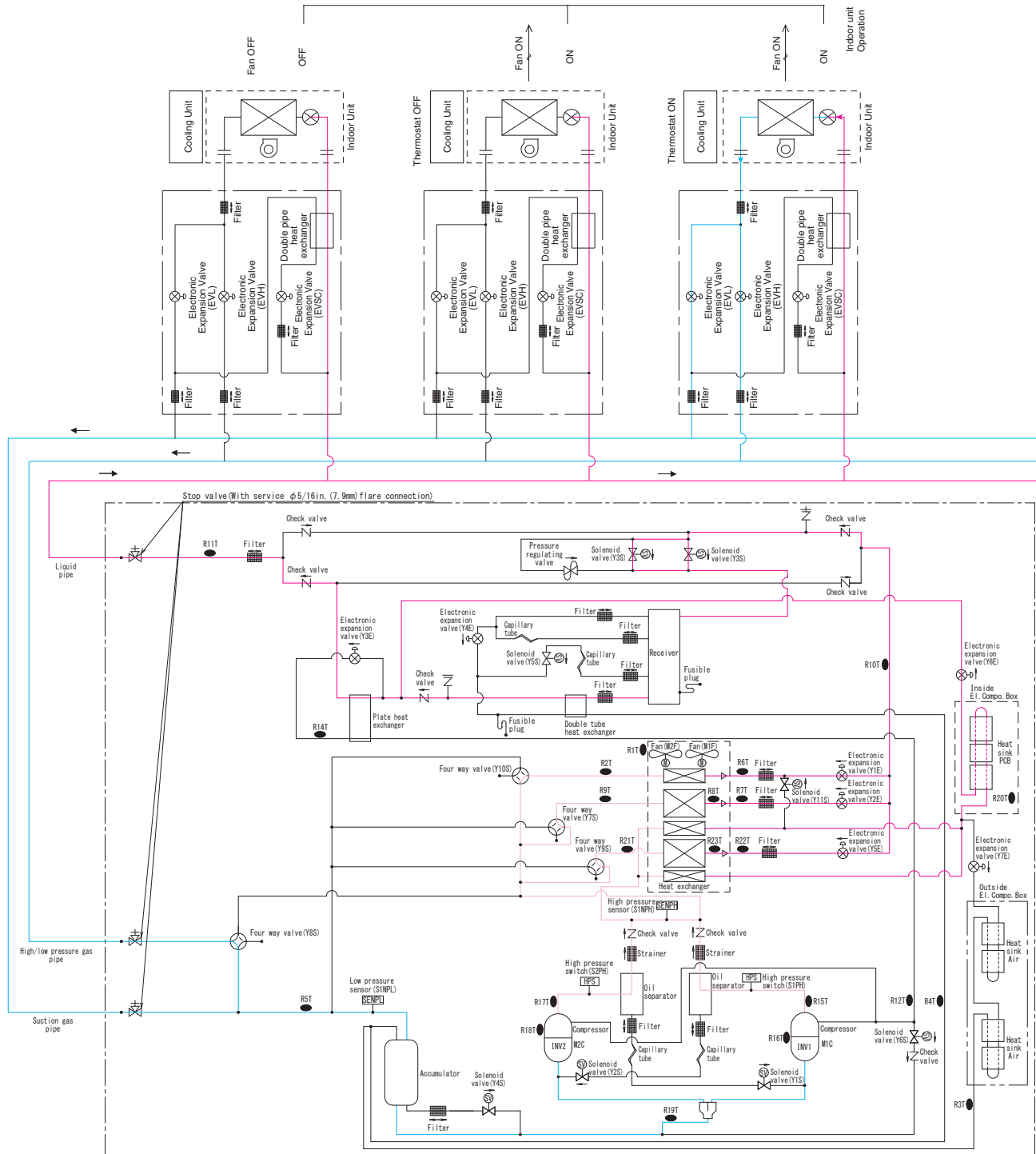

C: 3D135727C

Heating Operation

- High temperature, high pressure gas
- High temperature, high pressure liquid
- Low temperature, low pressure gas
- Low temperature, low pressure liquid

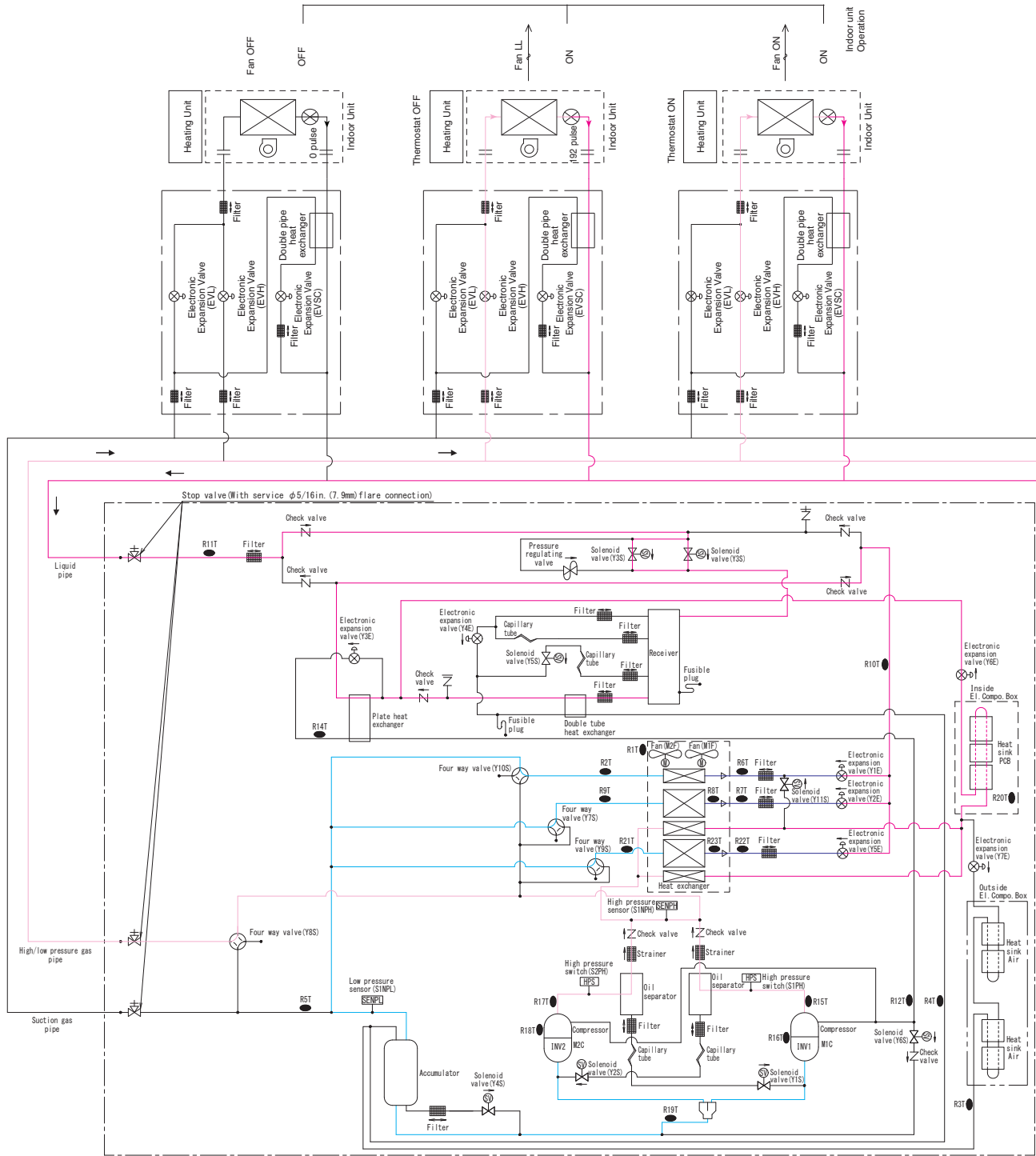

C: 3D13572C

Simultaneous Cooling and Heating Operation

- High temperature, high pressure gas
- High temperature, high pressure liquid
- Low temperature, low pressure gas
- Low temperature, low pressure liquid

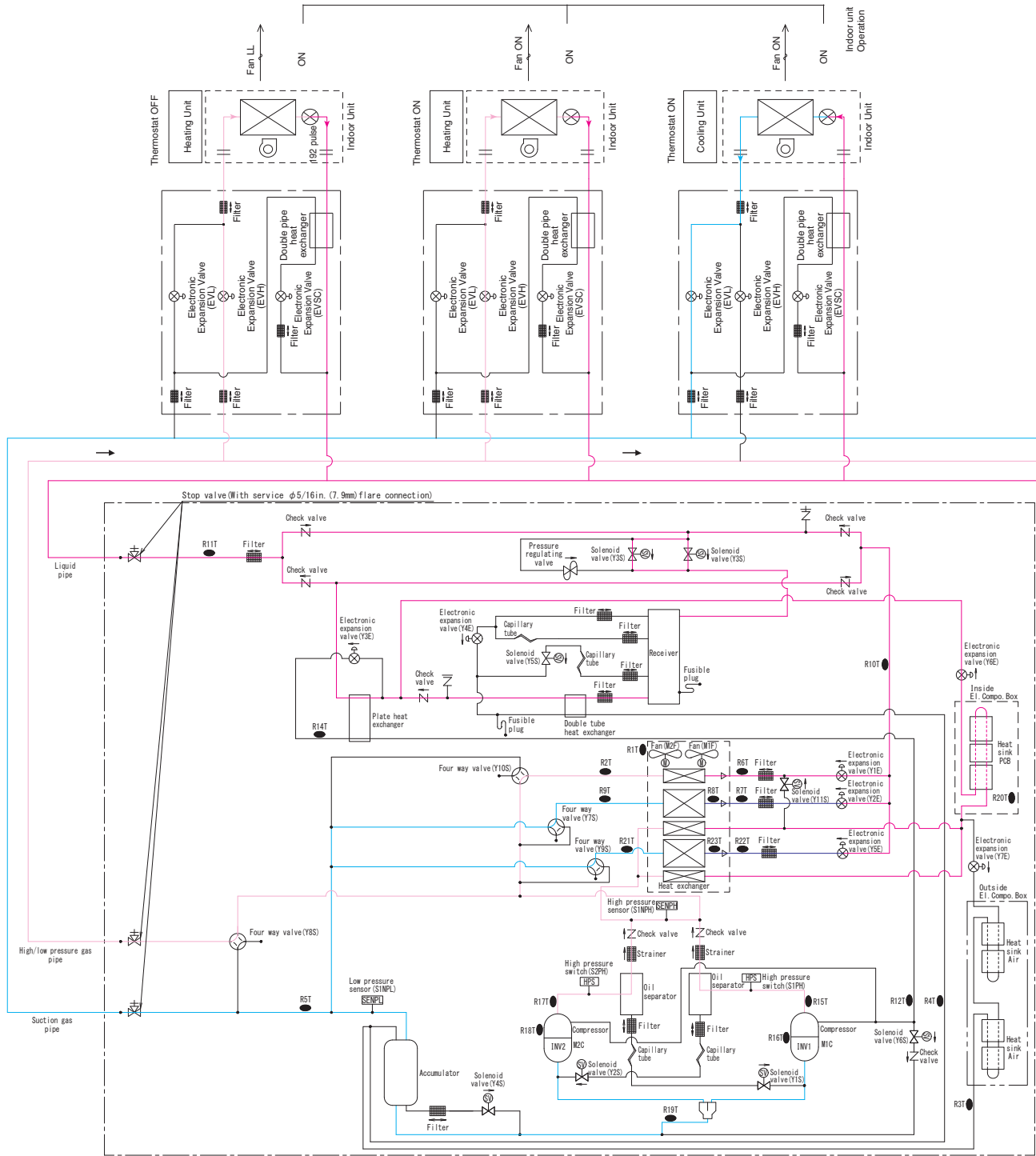

C: 3D13572C

Cooling Oil Return Operation

- High temperature, high pressure gas
- High temperature, high pressure liquid
- Low temperature, low pressure gas
- Low temperature, low pressure liquid

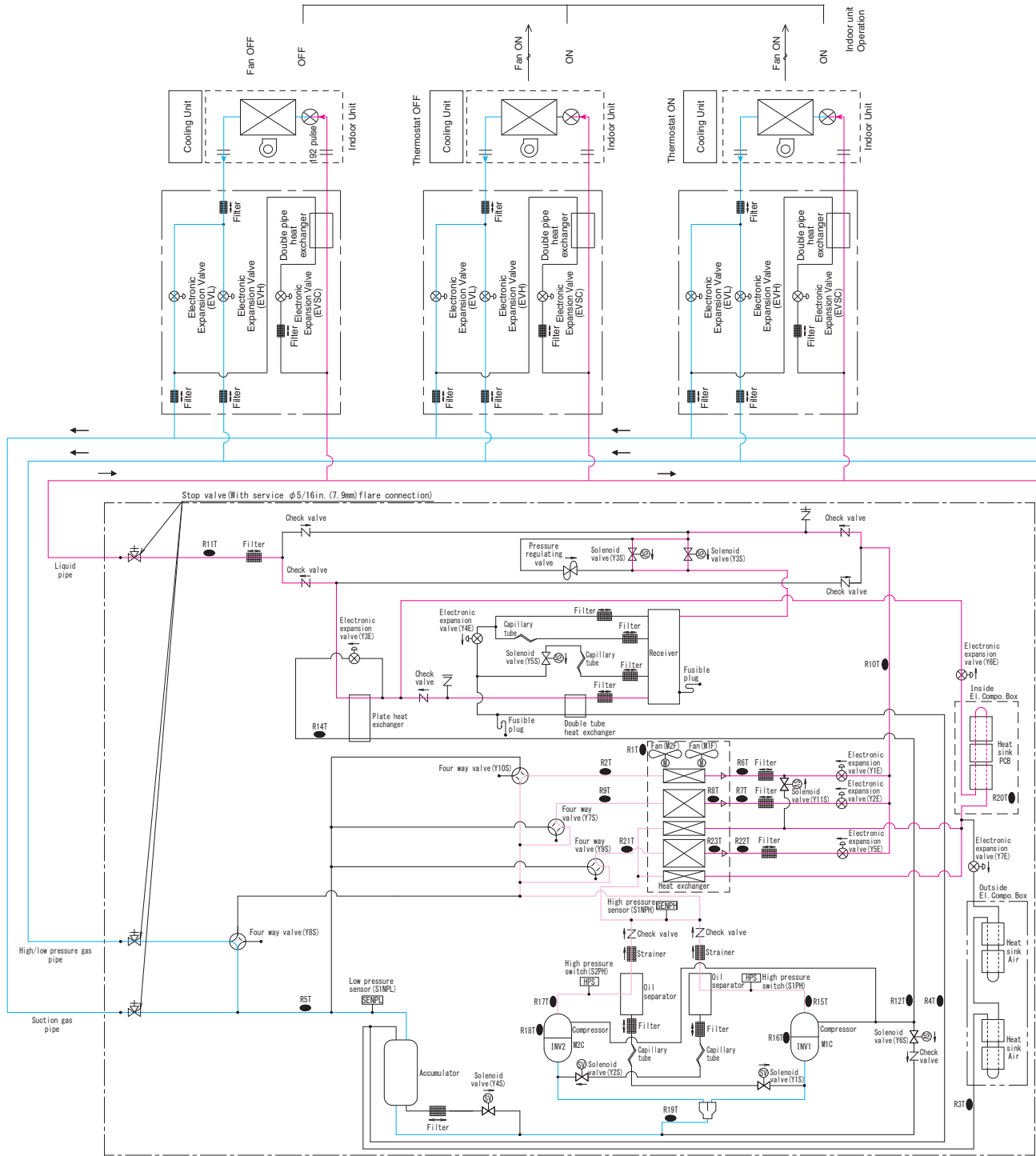

C: 3D13572C



### Defrost Heating Oil Return Operation

- High temperature, high pressure gas
- High temperature, high pressure liquid
- Low temperature, low pressure gas
- Low temperature, low pressure liquid

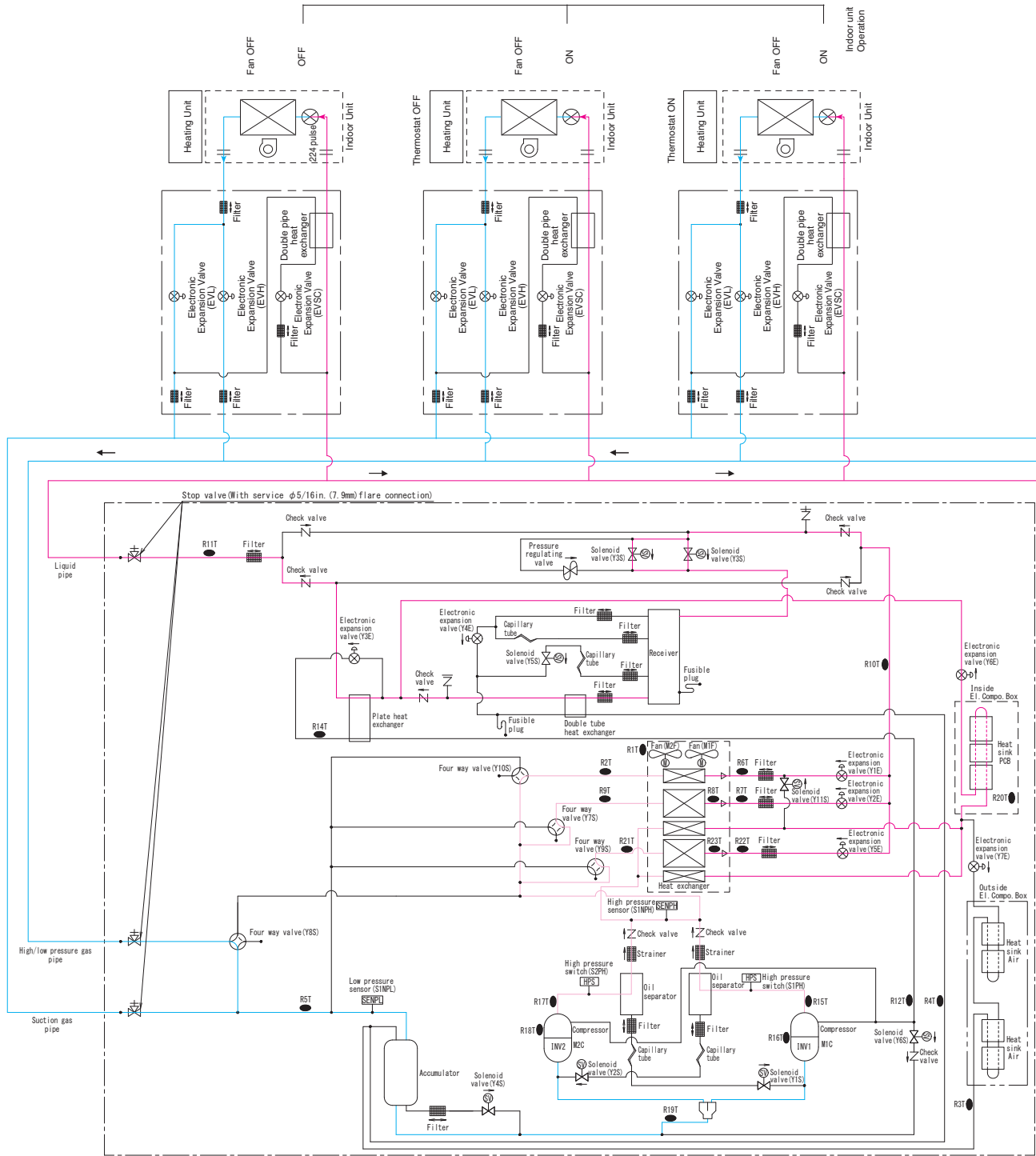

C: 3D13572C

Oil Return Operation at Simultaneous Cooling and Heating Operation

- High temperature, high pressure gas
- High temperature, high pressure liquid
- Low temperature, low pressure gas
- Low temperature, low pressure liquid

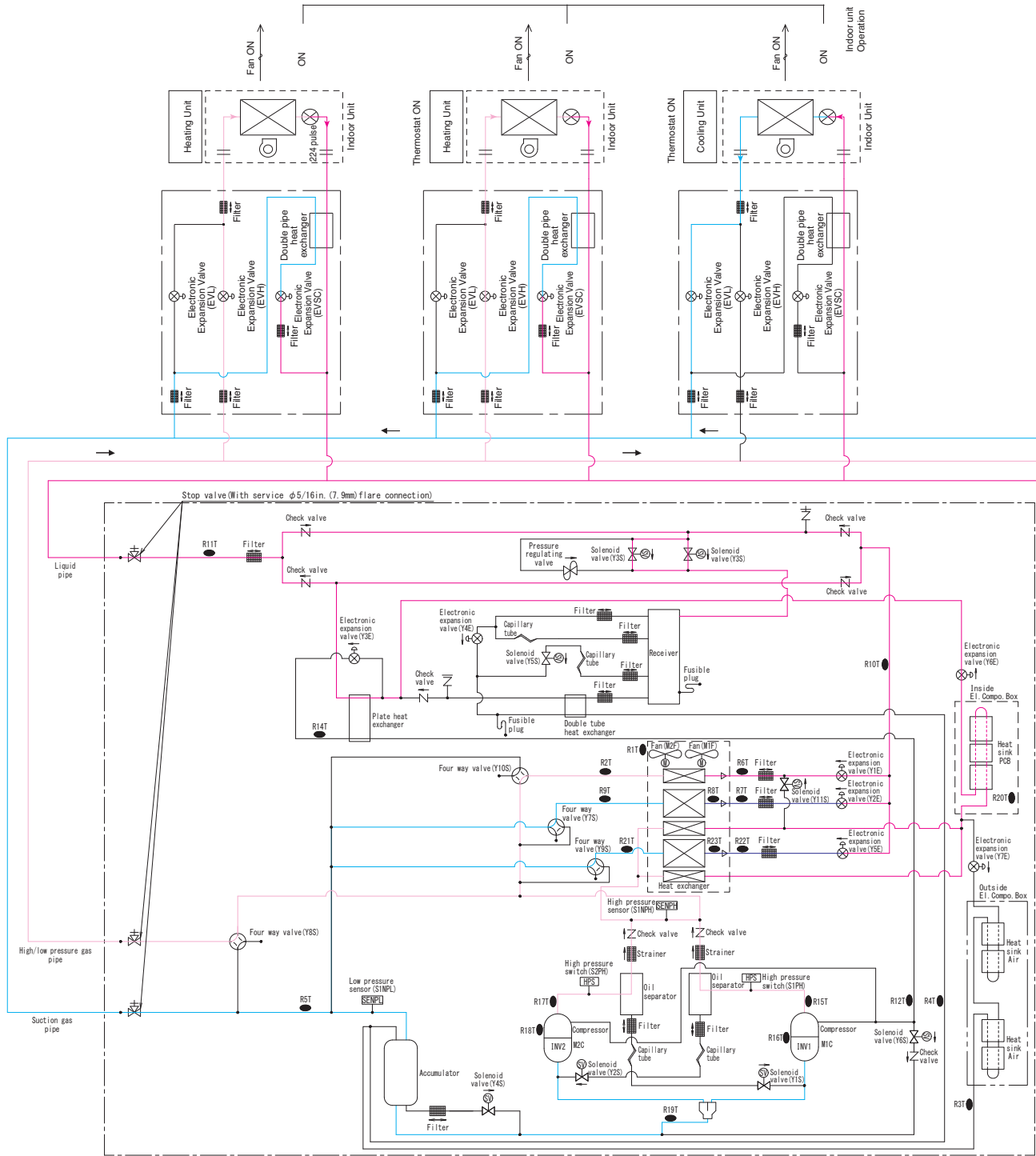

C: 3D13572C

# Part 3

## Remote Controller

1. Applicable Models .....	113
2. Names and Functions .....	114
2.1 BRC1E73 .....	114
2.2 BRC1H71W.....	117
2.3 Wireless Remote Controller .....	125
3. Main/Sub Setting.....	126
3.1 BRC1E73 .....	126
3.2 BRC1H71W.....	128
3.3 When Wireless Remote Controller is Used Together.....	130
4. Address Setting for Wireless Remote Controller.....	131
5. Centralized Control Group No. Setting.....	133
5.1 BRC1E73 .....	133
5.2 BRC1H71W.....	135
5.3 Wireless Remote Controller .....	135
5.4 Group No. Setting Example.....	136
6. Service Settings Menu, Maintenance Menu.....	137
6.1 BRC1E73 .....	137
7. Administrator Menu, Installer Menu .....	141
7.1 BRC1H71W.....	141

# 1. Applicable Models

Series	Wired remote controller		Wireless remote controller
	Navigation	Madoka	
FXFQ-AA	BRC1E73	BRC1H71W	—
FXFQ-T			—
FXZQ-TA			BRC082A42W (for BYFQ60C3W1W) BRC082A42S (for BYFQ60C3W1S) BRC082A41W (for BYFQ60B3W1)
FXZQ-TB			BRC082A42W (for BYFQ60C3W2W) BRC082A41W (for BYFQ60B3W1)
FXUQ-P			—
FXUQ-PA			—
FXEQ-P			—
FXDQ-M			BRC4C82
FXSQ-TA			BRC082A43
FXSQ-TB			—
FXMQ-PB			BRC4C82 (Fan: 2 steps) BRC082A43 (Fan: 3 steps)
FXMQ-TB			BRC082A43
FXMQ-TA			—
FXMQ-M			BRC4C82
FXHQ-M	BRC7E83		
FXAQ-P	BRC7E818		
FXLQ-M	—		
FXNQ-M	BRC1E73	BRC1H71W	—
FXTQ-TA			—
FXTQ-TB			—
CXTQ-TA			BRC4C82
FXMQ-MF			—
VAM-G	—	—	

## 2. Names and Functions

### 2.1 BRC1E73

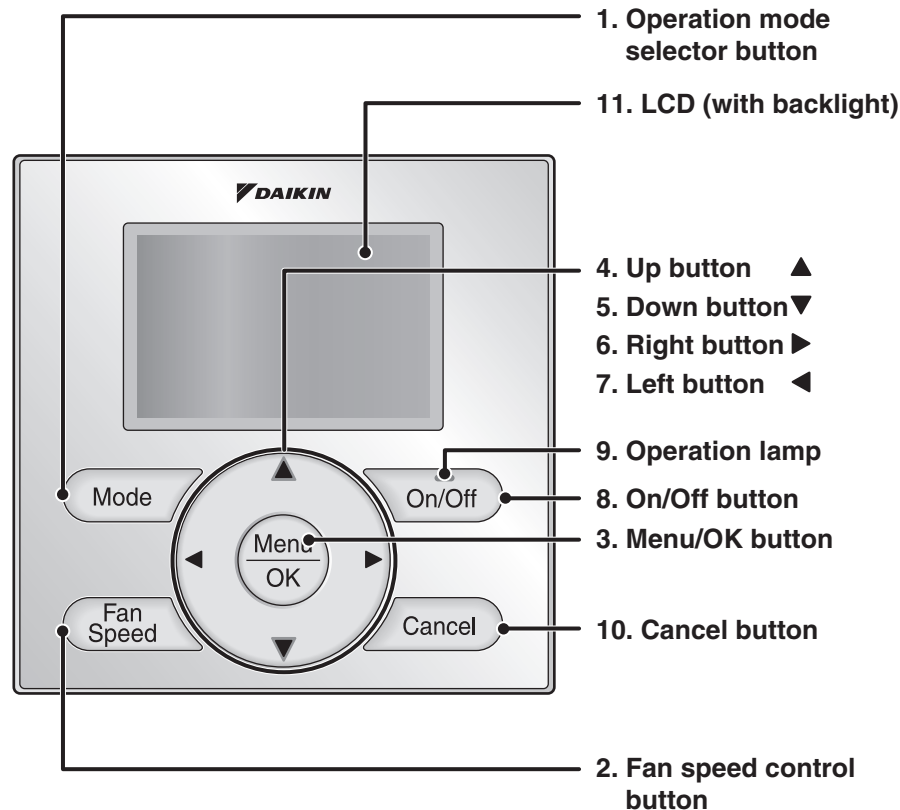

Functions other than basic operation items (i.e., On/Off, Operation Mode, Fan Speed, and Setpoint) are set from the menu screen.



#### Note(s)

- Do not install the remote controller in places exposed to direct sunlight, the LCD will be damaged.
- Do not pull or twist the remote controller cord, the remote controller may be damaged.
- Do not use objects with sharp ends to press the buttons on the remote controller damage may result.

#### 1. Operation mode selector button

- Press this button to select the operation mode of your preference.
- \* Available modes vary with the indoor unit model.

#### 2. Fan speed control button

- Press this button to select the fan speed of your preference.
- \* Available fan speeds vary with the indoor unit model.

#### 3. Menu/OK button

- Used to enter the main menu.
- Used to enter the selected item.

**4. Up button ▲**

- Used to raise the setpoint.
- The item above the current selection will be highlighted. (The highlighted items will be scrolled continuously when the button is continuously pressed.)
- Used to change the selected item.

**5. Down button ▼**

- Used to lower the setpoint.
- The item below the current selection will be highlighted. (The highlighted items will be scrolled continuously when the button is continuously pressed.)
- Used to change the selected item.

**6. Right button ►**

- Used to highlight the next items on the right-hand side.
- Each screen is scrolled in the right-hand direction.

**7. Left button ◀**

- Used to highlight the next items on the left-hand side.
- Each screen is scrolled in the left-hand direction.

**8. On/Off button**

- Press this button and system will start.
- Press this button again to stop the system.

**9. Operation lamp**

- This lamp illuminates solid green during normal operation.
- This lamp blinks if an error occurs.

**10. Cancel button**

- Used to return to the previous screen.

**11. LCD (with backlight)**

- The backlight will be illuminated for approximately 30 seconds by pressing any button.
- If two remote controllers are used to control a single indoor unit, only the controller accessed first will have backlight functionality.



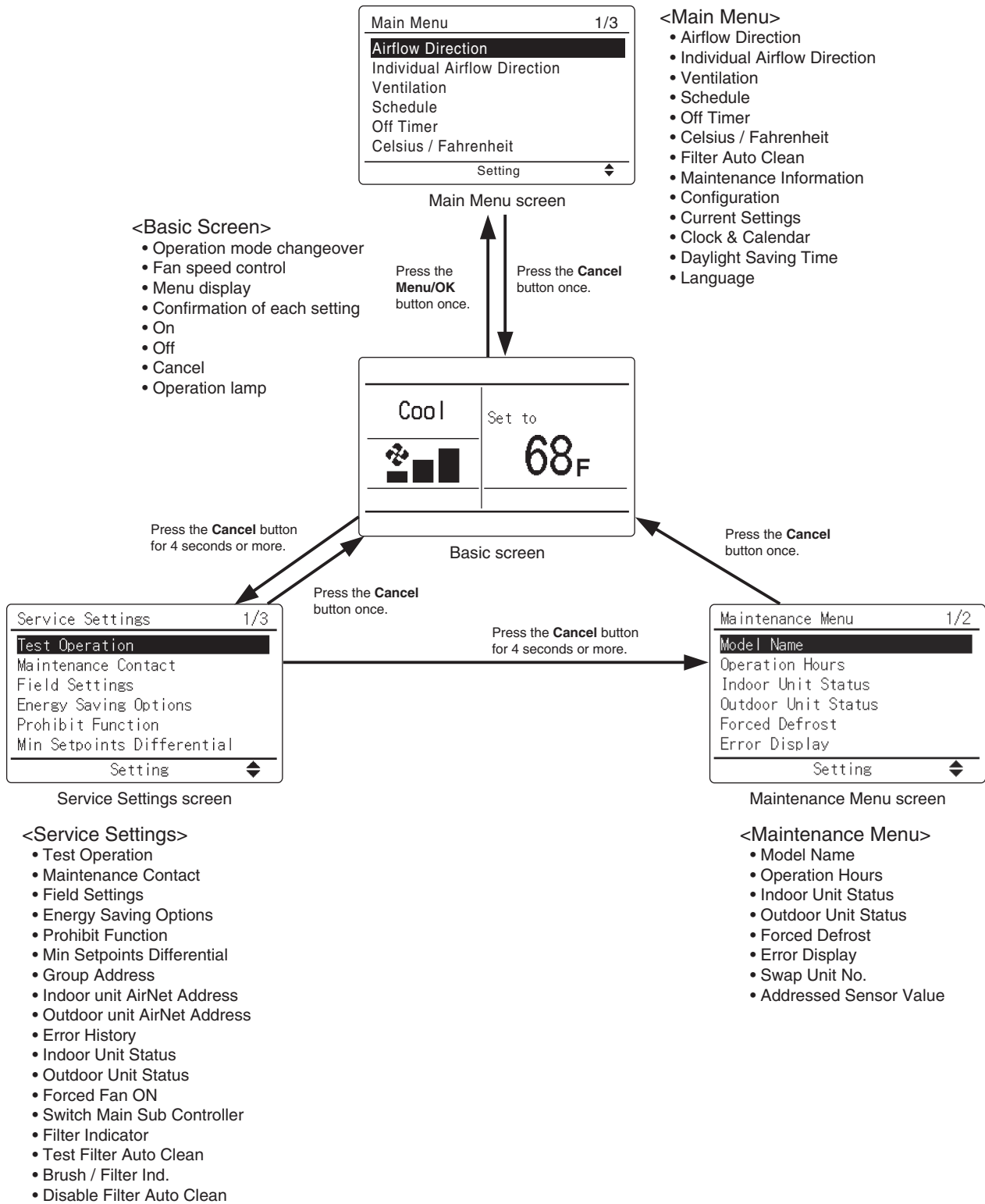

**Service Check Function**

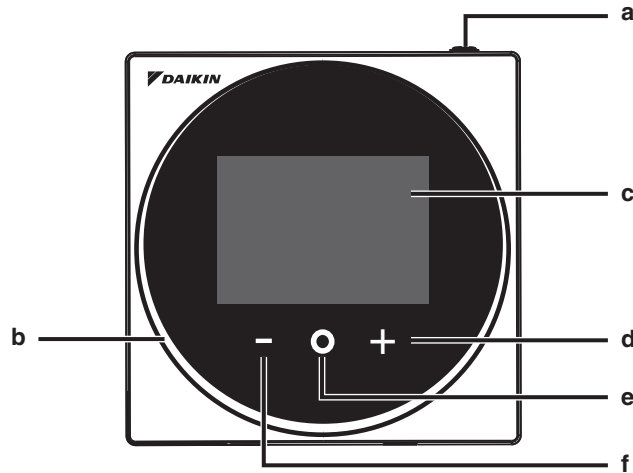

## 2.2 BRC1H71W

### 2.2.1 Button Locations and Descriptions



- a**  **ON/OFF button**
- Press this button to turn on the system.
  - Press this button again to turn off the system.
- b** **Status indicator (LED)**
- During operation, the light ring around the display lights up blue/red/green.  
Lights up blue: Operating, Blinks red: Error is occurring, Lights up/blinks green: Bluetooth connecting
- c** **LCD**
- Displays the current setpoint and air conditioner operation status.
- d**  **NAVIGATE/ADJUST button**
- Navigate right.
  - Adjust a setting.
- e**  **SELECT/ACTIVATE/SET button**
- From the home screen, enter the user menu.
  - From the user menu, enter one of the submenus.
  - From their respective submenu, activate an operation/ventilation mode.
- f**  **NAVIGATE/ADJUST button**
- Navigate left.
  - Adjust the setting.



## 2.2.2 Overview of Screens



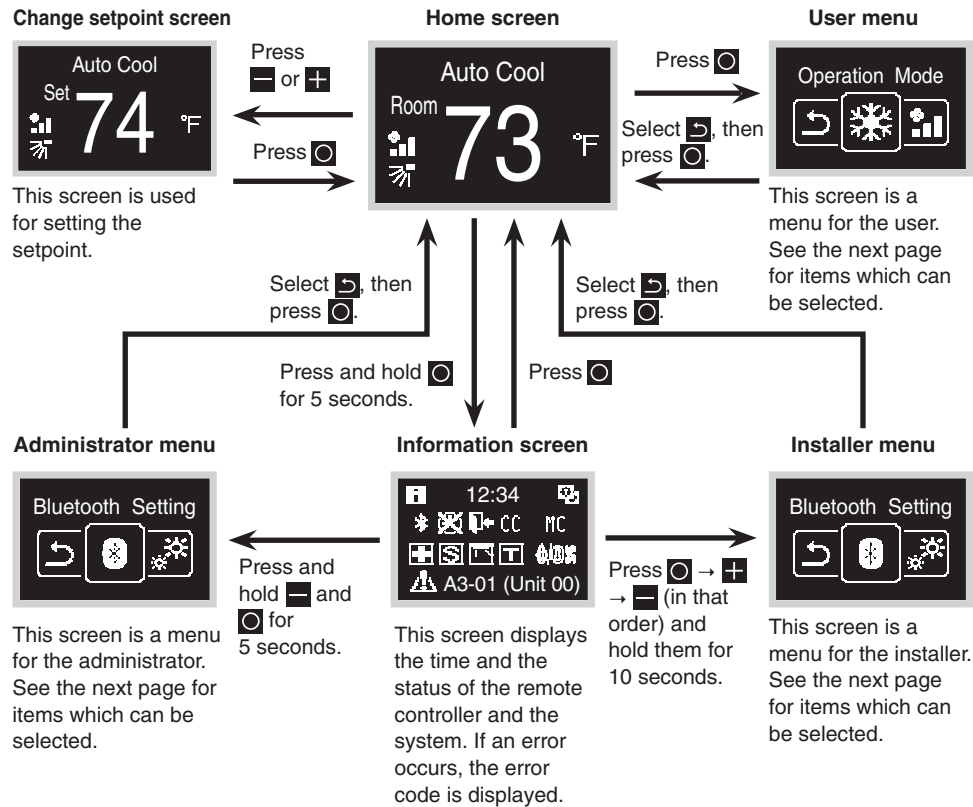

The following is just an example. The items available for setting vary depending on the indoor unit you are using. If there is no button operation for about 10 seconds, the screen returns to the home screen.

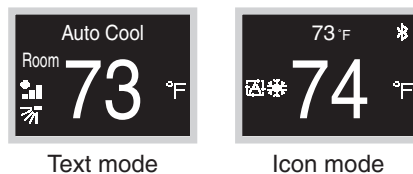













There are 2 screen display modes, text mode and icon mode.  
 Change the mode according to your preference.  
 \* All of the above explanations are shown with screens from text mode.



## 2.2.3 Setting Screen List

Setting list			User menu	Administrator menu	Installer menu
Icon	Name	Description			
Depends on current setting	Operation Mode	Operation mode setting	●		
Depends on current setting	Fan Speed	Airflow rate setting	●		
Depends on current setting	Airflow Direction	Airflow direction 1 setting	●		
Depends on current setting	Vertical Airflow	Airflow direction 2 setting	●		
Depends on current setting	Ventilation Mode	Ventilation mode setting	●		
Depends on current setting	Ventilation Rate	Ventilation rate setting	●		
	Adjust LED (ON)	LED brightness adjustment when backlight lights up	●		
	Adjust LED (OFF)	LED brightness adjustment when backlight lights up dimly	●		
	Celsius/Fahrenheit	Fahrenheit/Celsius changeover	●		
	Setpoint	Setpoint setting when in auto operation mode	●		
	Sign Reset	Filter sign reset	●		

Setting list			User menu	Administrator menu	Installer menu
Icon	Name	Description			
	Bluetooth Setting	Bluetooth setting		●	●
	Backlight	Backlight brightness setting		●	●
	Contrast	Contrast setting		●	●
	Clock Setting	Clock setting		●	●
	Standard Temp	Scale reference temperature setting		●	●
	About	Administrator information		●	●
	Admin Password	Administrator password setting		●	
	Installer Password	Installer password setting			●
	Field Setting	Field Setting			●
	R/C Setting	R/C Setting			●
	Address Setting	Address Setting			●
	Forced Fan ON	Forced Fan ON Setting			●
	Rel Master Control	Release changeover master			●

## 2.2.4 Names and Functions

### Home screen

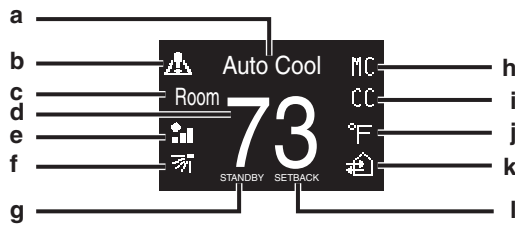

### Information screen



### User menu/Administrator menu/Installer menu

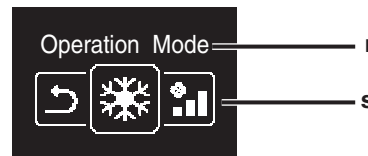

User menu

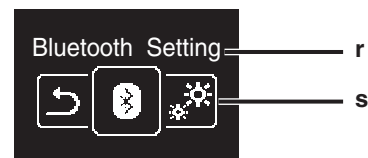

Administrator menu/Installer menu

The Bluetooth® word mark and logos are registered trademarks owned by the Bluetooth SIG, Inc. and use of such marks by Daikin industries, LTD. is under license. Other trademarks and trade names are those of their respective owners.

### **i** INFORMATION

Depending on the connected model, some items may not be displayed. The controller is equipped with a power-saving function that darkens the display if there is no operation for a certain period of time. To make the screen light up again, press one of the buttons. Note that pressing one of the buttons will only make the display bright again, not cause remote controller operation.

\* All screens shown are from text mode.

### Screen display explanation

- a Operation mode/OFF display**
  - Displays the operation status.
- b Error/Filter/Test icon**
  - Error, filter and test icons are displayed.
- c Room/Set**
  - Indicates whether it's a room temperature display (Room) or setpoint display (Set).
- d Room temperature/Set temperature**
  - Displays the current room or setpoint temperature.
- e Fan speed**
  - Displays the set fan speed.
- f Airflow direction**
  - Displays the set airflow direction.
- g STANDBY**
  - Displays during defrost/hot start.
- h Changeover controlled by the master indoor unit**
  - Displayed when another indoor unit on the system has the authority to change the operation mode between cool and heat.
- i Under centralized control**
  - Displayed if the system is under the management of a multi-zone controller (Optional) and the operation of the system through the remote controller is limited.
- j Fahrenheit/Celsius**
  - Depending on the setting, Fahrenheit/ Celsius display can be selected.
- k Ventilation operation/Air Purify**
  - Displayed when a Heat Reclaim Ventilator is connected.
- l Setback**
  - Blinks during setback operation.
  - Displayed during setback setting.
- m Information icon**
- n Clock (24 hours time display)**
- o MAIN/SUB remote controller sign**
- p Status**
  - Notifies the status.
- q Error display**
  - If an error occurs, the icon, an error code and unit number are displayed.
- r Settings menu name**
- s Settings menu icon**

## Home screen list

There are 4 types of home screen.

The home screen type can be changed by the remote controller setting.

Text mode

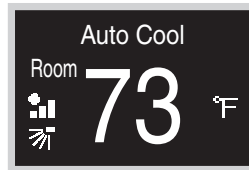

Icon mode



Text mode (Scale screen)

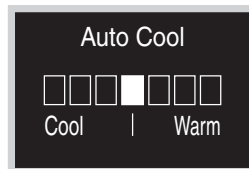

Icon mode (Scale screen)

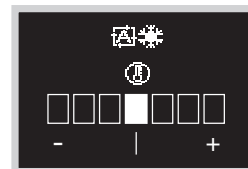

When in the scale screen, the setpoint can be changed in the range of  $\pm 3^{\circ}\text{C}/^{\circ}\text{F}$  of the reference temperature.

The reference temperature can be changed from the smartphone application or the remote controller (from the administrator menu).

## 2.2.5 Information Screen

The functions of the connected indoor unit are displayed as icons.

### How to display the information screen

Home screen

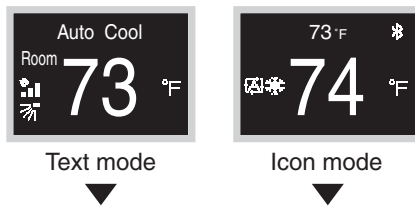

Press and hold  on the Home screen for 5 seconds.

Information screen

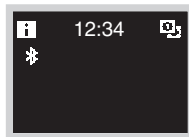

The screen switches to the Information screen.

### How to exit the information screen

















Information screen



Press  or there is no button operation for about 10 seconds, the screen returns to the home screen.

## About icons on the information screen

The items displayed vary depending on the indoor unit you are using.

Icon	Name	Description
	<b>Information</b>	Indicates an information screen.
	<b>MAIN/SUB remote controller</b>	Displayed when used as the MAIN/SUB remote controller. 1=main, 2=sub
	<b>Bluetooth*</b>	Indicates that the controller is communicating with a mobile device, for use with the app.
	<b>Clock not set</b>	Indicates that the clock needs to be set again.
	<b>Setback</b>	Indicates that the indoor unit is operating under setback conditions.
	<b>Under centralized control</b>	Indicates that the system is controlled by central control equipment (optional accessory) and that control of the system by the controller is limited.
	<b>Changeover controlled by the master indoor unit</b>	<b>Displayed:</b> The remote controller does not have master control. Unable to select heating/cooling operation. <b>Blinking:</b> None of the remote controllers in the system have master control. Can be set as the master controller during this time. <b>Not Displayed:</b> The remote controller has master control. Able to select heating/cooling operation.
	<b>Backup</b>	Indicates that backup operation is being carried out.
	<b>Energy savings</b>	Indicates that the system's energy consumption is being limited, and that it is running with restricted capacity.
	<b>Individual airflow direction</b>	Indicates that the individual airflow direction setting is enabled.
	<b>Test operation</b>	Indicates that Test Operation mode is active.
	<b>Stand by for Defrost/Hot start</b>	Indicates that the defrost/hot start mode is active.
	<b>Self-cleaning filter operation</b>	Indicates that self-cleaning filter operation is active.
	<b>Inspection</b>	Indicates that the indoor or outdoor unit is being inspected.
	<b>Periodic inspection</b>	Indicates that the indoor or outdoor unit is being inspected.
	<b>Ventilating operation</b>	Indicates that ventilating operation is being carried out.
	<b>Warning</b>	Indicates that an error occurred, or that an indoor unit component needs to be maintained.

\* The Bluetooth® word mark and logos are registered trademarks owned by the Bluetooth SIG, Inc. and use of such marks by Daikin industries, LTD. is under license. Other trademarks and trade names are those of their respective owners.

## 2.3 Wireless Remote Controller

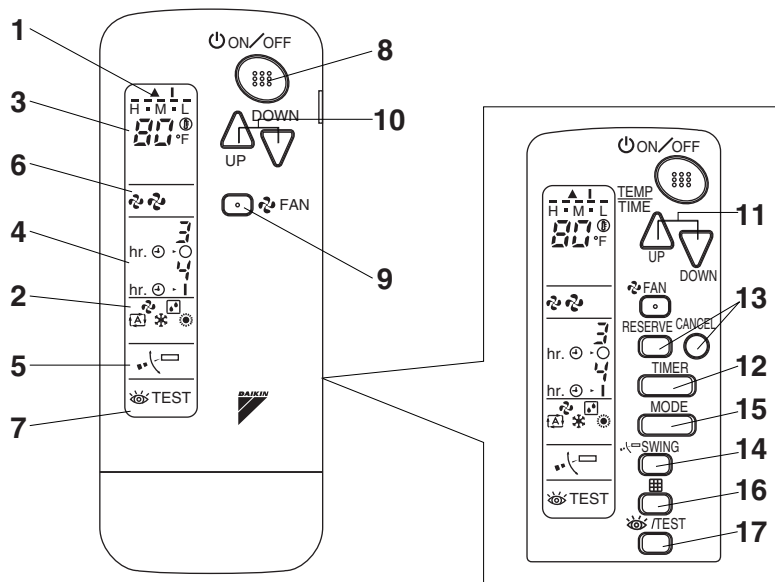

1	<b>DISPLAY ▲ (SIGNAL TRANSMISSION)</b> This lights up when a signal is being transmitted.
2	<b>DISPLAY     (OPERATION MODE)</b> This display shows the current OPERATION MODE.
3	<b>DISPLAY  (SET TEMPERATURE)</b> This display shows the set temperature.
4	<b>DISPLAY hr. ⓪ · 0 hr. ⓪ · 1 (PROGRAMMED TIME)</b> This display shows programmed time of the system start or stop.
5	<b>DISPLAY  (AIRFLOW FLAP)</b>
6	<b>DISPLAY  (FAN SPEED)</b> The display shows the set fan speed.
7	<b>DISPLAY  TEST (INSPECTION/TEST)</b> When the <b>INSPECTION/TEST</b> button is pressed, the display shows the system mode is in.
8	<b>ON/OFF BUTTON</b> Press the button and the system will start. Press the button again and the system will stop.

9	<b>FAN SPEED CONTROL BUTTON</b> Press this button to select the fan speed, HIGH or LOW, of your choice.
10	<b>TEMPERATURE SETTING BUTTON</b> Use this button for setting temperature (Operates with the front cover of the remote controller closed.)
11	<b>PROGRAMMING TIMER BUTTON</b> Use this button for programming start and/or stop time. (Operates with the front cover of the remote controller opened.)
12	<b>TIMER MODE START/STOP BUTTON</b>
13	<b>TIMER RESERVE/CANCEL BUTTON</b>
14	<b>AIRFLOW DIRECTION ADJUST BUTTON</b>
15	<b>OPERATION MODE SELECTOR BUTTON</b> Press this button to select operation mode.
16	<b>FILTER SIGN RESET BUTTON</b>
17	<b>INSPECTION/TEST BUTTON</b> This button is used only by qualified service persons for maintenance purposes.



## 3. Main/Sub Setting

### 3.1 BRC1E73

#### Situation

The Main/Sub setting is necessary when 1 indoor unit is controlled by 2 remote controllers. When you use 2 remote controllers (control panel and separate remote controller), set one to Main and the other to Sub.

#### Setting

The remote controllers are factory setting to Main, so you only have to change one remote controller from Main to Sub. To change a remote controller from Main to Sub, proceed as follows:

#### 3.1.1 Field Settings

The designation of the main and sub remote controllers can be swapped. Note that this change requires turning the power OFF and then ON again.

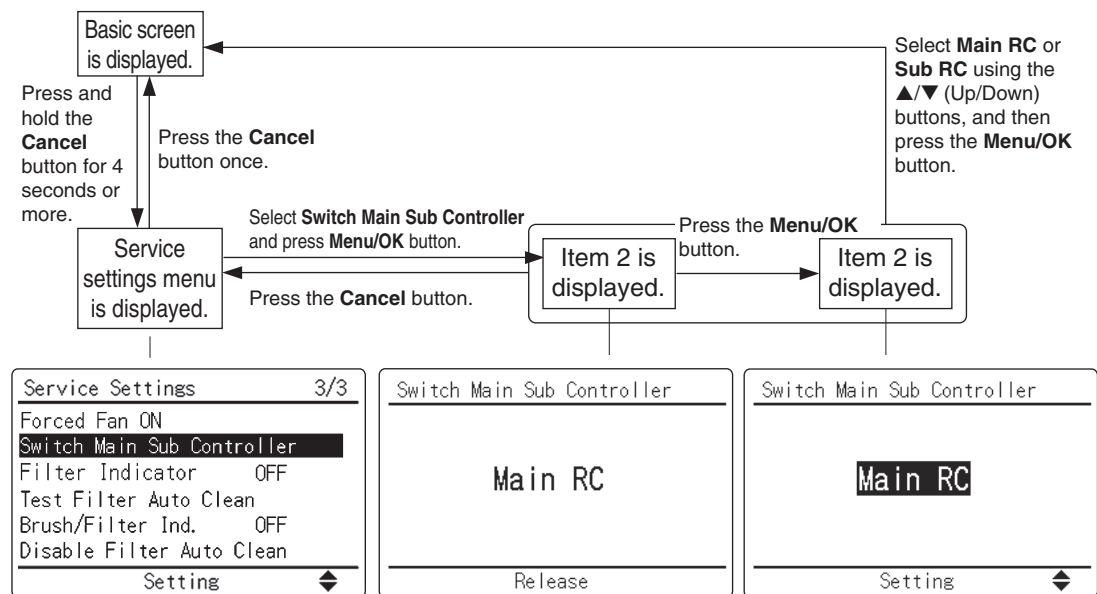

### 3.1.2 When an Error Occurred

**U5: there are 2 main remote controllers when power is turned ON**

→Change the setting from Main to Sub on the remote controller you want to be Sub.

**U8: there are 2 sub remote controllers when power is turned ON**

→Change the setting from Sub to Main on the remote controller you want to be Main.

#### How to confirm Main/Sub setting

The Main/Sub setting of the remote controller is displayed on the bottom of the screen while **Checking the connection. Please stand by.** is displayed.

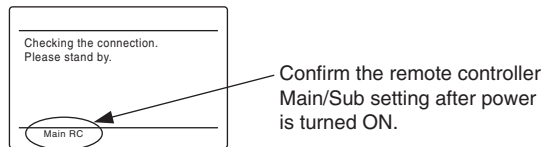

#### How to change Main/Sub setting

You may change the Main/Sub setting of the remote controller while **Checking the connection. Please stand by.** is displayed by pressing and holding the **Mode Selector** button for 4 seconds or longer.

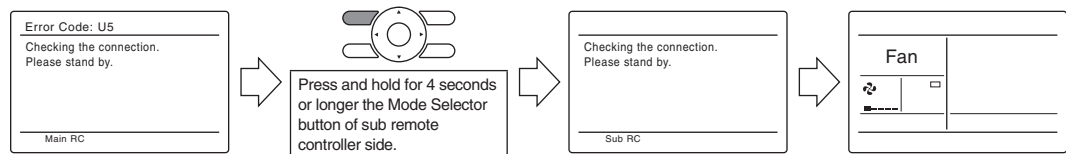

#### Note(s)

1. It is not possible to change the Main/Sub setting from Main to Sub when only one remote controller is connected.
2. When 2 remote controllers are being used, it is not possible to change the setting from Main to Sub if one of the remote controllers is already set as Main.

## 3.2 BRC1H71W

### 3.2.1 Main and Sub Controller

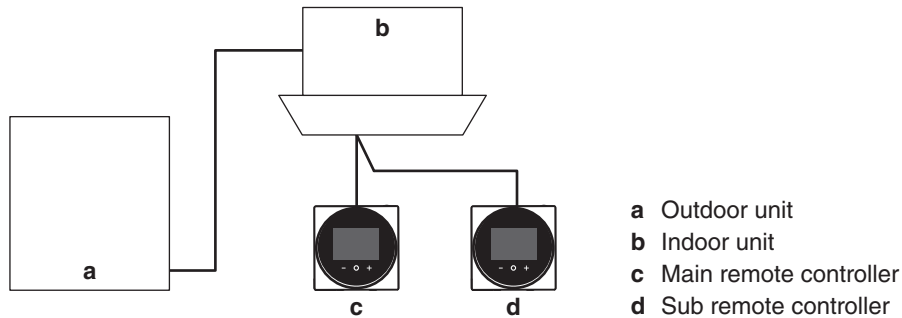

- On the information screen, main/sub status is indicated by the following icons:

Icon	Description
	Main
	Sub

#### **i** INFORMATION

It is only possible to use a main and a sub controller of the same type.

#### **i** INFORMATION

If a sub controller does not display the home screen 2 minutes after its designation, turn off the power and check the wiring.

#### **i** INFORMATION

After re-designating a controller, the system requires a power reset.

#### **i** INFORMATION

The following functions are not available for sub controllers:

- “Auto” operation mode
- Individual airflow direction
- Filter auto clean
- Setback temperature setpoints
- Draft prevention

## 3.2.2 Designating a Controller as Main or Sub

**Prerequisite:** A remote controller is already connected to the indoor unit.

Connect a second controller.

After turning on the power, perform setting of the second controller.

**Result:** It will start up automatically.



Home screen



Wait for a U5 or U8 error code to appear on the screen.

Screen display explanation

1 main

2 sub



Home screen



When the U5 error code appears, press  and hold until "2" appears on the screen.

When the U8 error code appears, press  and hold until "1" appears on the screen.

**Result:**

A controller displaying 1 is set as main, and a controller displaying 2 is set as sub.

### INFORMATION

If sub remote controller is not set at power-on in the case of one indoor unit controlled by two remote controllers, Error Code: U5 is displayed in the connection checking screen.

If the sub remote controller does not display the home screen two minutes after its designation, turn off the power and check the wiring.

### 3.3 When Wireless Remote Controller is Used Together

When using both a wired and a wireless remote controller for 1 indoor unit, the wired controller should be set to Main. Therefore, the Main/Sub switch (SS1) of the signal receiver PCB must be set to Sub.

Main/Sub	Main	Sub
Main/Sub switch (SS1)		

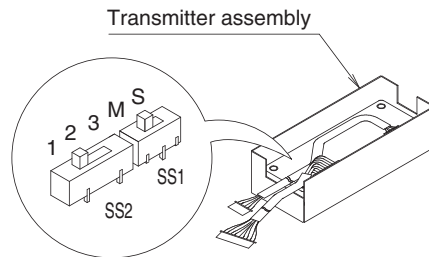
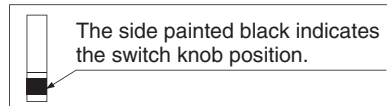

## 4. Address Setting for Wireless Remote Controller



If setting multiple wireless remote controllers to operate in one room, perform address setting for the receiver and the wireless remote controller.

(This includes an individual remote controller control using the group operation.)

(For the wiring for the group operation, please refer to the installation manual attached to the indoor unit.)

### Setting for signal receiver PCB

The address for the receiver is set to 1 at the factory. To change the setting, set the wireless address switch (SS2) on the signal receiver PCB according to the table below.

Unit No.	No. 1	No. 2	No. 3
Wireless address switch (SS2)			

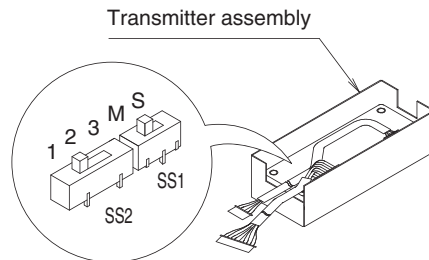
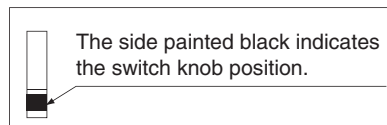

### Setting for wireless remote controller

The address for the wireless remote controller is set to 1 at the factory. To change the setting, proceed as follows:

1. Press **FILTER SIGN RESET** button and **INSPECTION/TEST** button at the same time for 4 seconds to enter field setting mode. (**SETTING** is indicated on the display.)
2. Press **FAN** button and select **A** or **b**. Each time the button is pressed, the display switches between **A** and **b**.
3. Press **UP** button or **DOWN** button to select an address from 1-3 as same as the receiver. Address can be set from 1-6, but the receiver does not work with addresses 4-6.

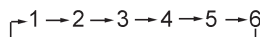

4. Press **RESERVE** button to confirm the setting.

5. Press **INSPECTION/TEST** button for 1 second to return to normal mode.

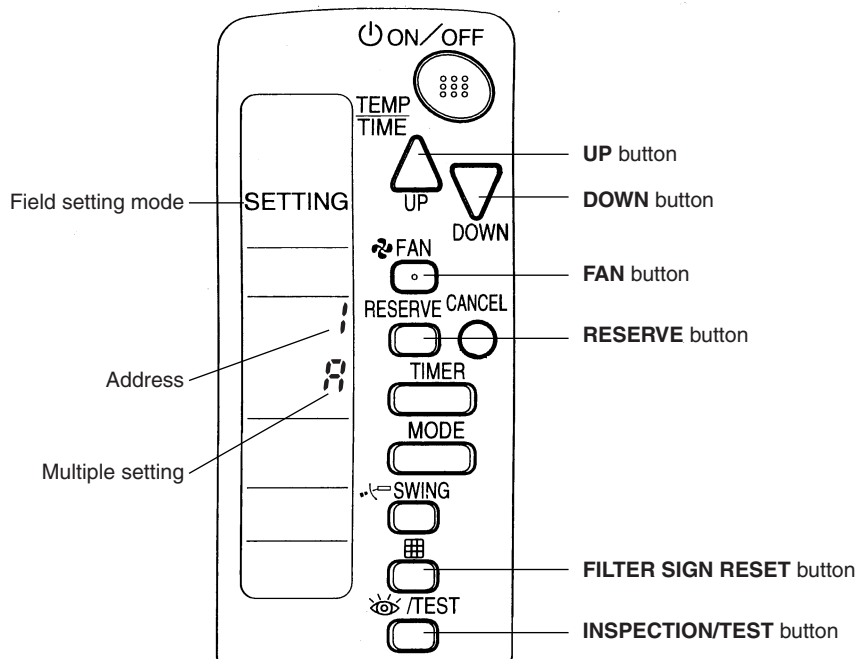

**Multiple Settings A/b**

The command such as operation mode or temperature setting by this remote controller will be rejected when the target indoor unit operation is restricted as by an external control such as centralized control.

Since the setting acceptance is hard to discriminate with such circumstances there are two setting options provided to enable discriminating by a beeping sound according to the operation:

**A:** Standard or **b:** Multi System. Set the setting according to the customer's intention.

Remote Controller		Indoor Unit	
Multiple setting	Display on remote controller	Behavior to the remote controller operation when the functions are restricted as by an external control.	Other than the left
<b>A:</b> Standard (factory set)	All items displayed.	Accepts the functions except restricted. (Sounds one long beep or three short beeps) There may be a difference from the indoor unit status with remote controller display.	Accepts all items transmitted (Sounds two short beeps) The remote controller display agrees with the indoor unit status.
<b>b:</b> Multi System	Display only items transmitted for a while.	<p><b><u>When some restricted functions are included in the transmitted items</u></b>                      Accepts the functions except restricted. (Sounds one long beep or three short beeps) There may be a difference from the indoor unit status with remote controller display.</p> <p><b><u>When no restricted function is included</u></b>                      Accepts all items transmitted (Sounds two short beeps) The remote controller display agrees with the indoor unit status.</p>	

# 5. Centralized Control Group No. Setting

## 5.1 BRC1E73

In order to conduct the centralized remote control using the central remote controller and the unified ON/OFF controller, Group No. settings should be made by group using the operating remote controller.

Make Group No. settings for centralized remote control using the operating remote controller.

### When initializing Group Address

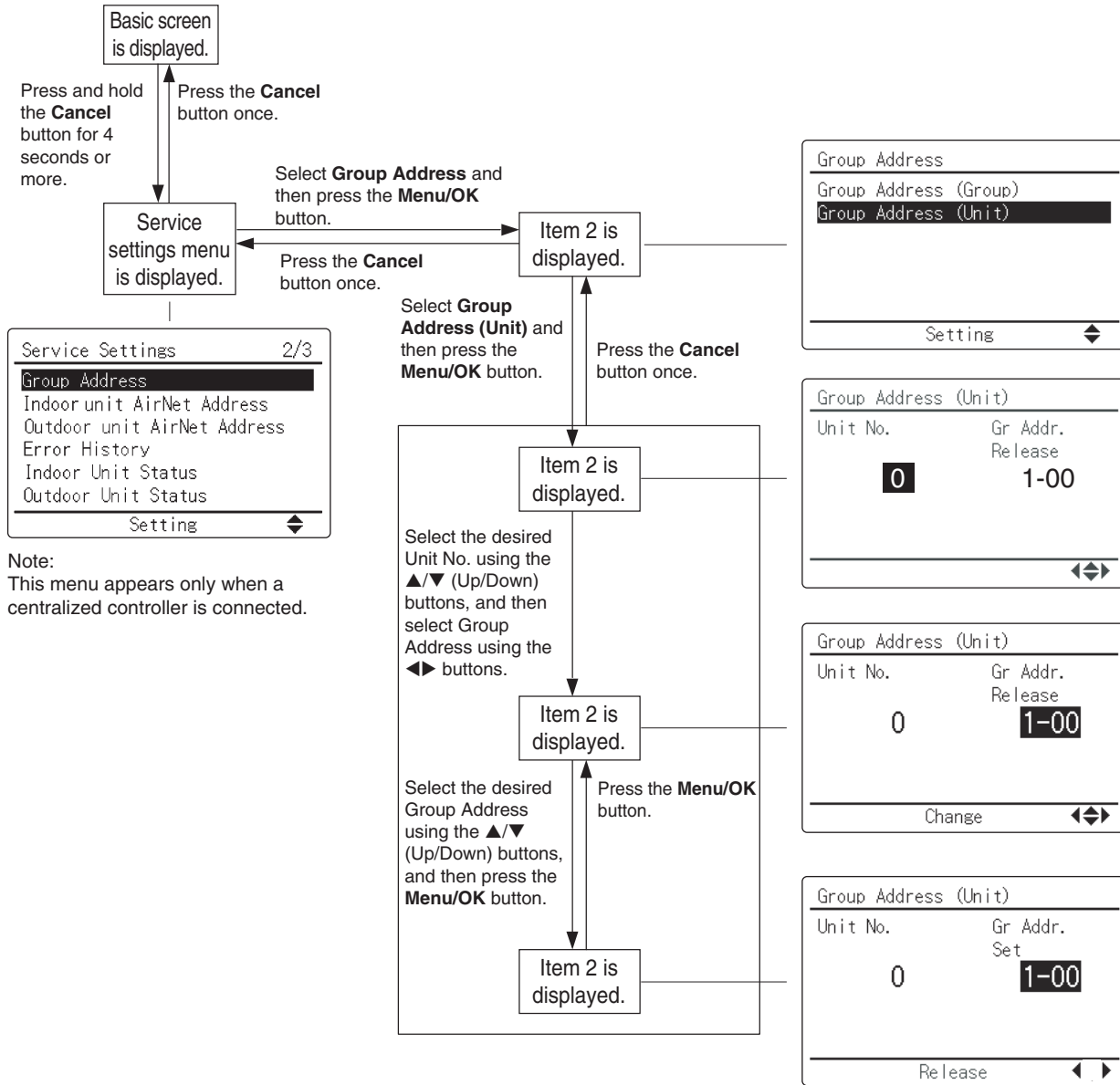

Note:  
This menu appears only when a centralized controller is connected.

Service settings menu	Item 2
Group Address	Group Address (Group)
	Group Address (Unit)

#### ■ Description

This menu is used to make group address setting for centralized control. It is also used to make group address setting by indoor unit.



**i Note(s)** ■ For setting group No. of Energy recovery ventilator and wiring adaptor for other air conditioners, etc., refer to the instruction manual.

**NOTICE**

Enter the group No. and installation place of the indoor unit into the installation table. Be sure to keep the installation table with the operation manual for maintenance.

**Group Address (Group)**

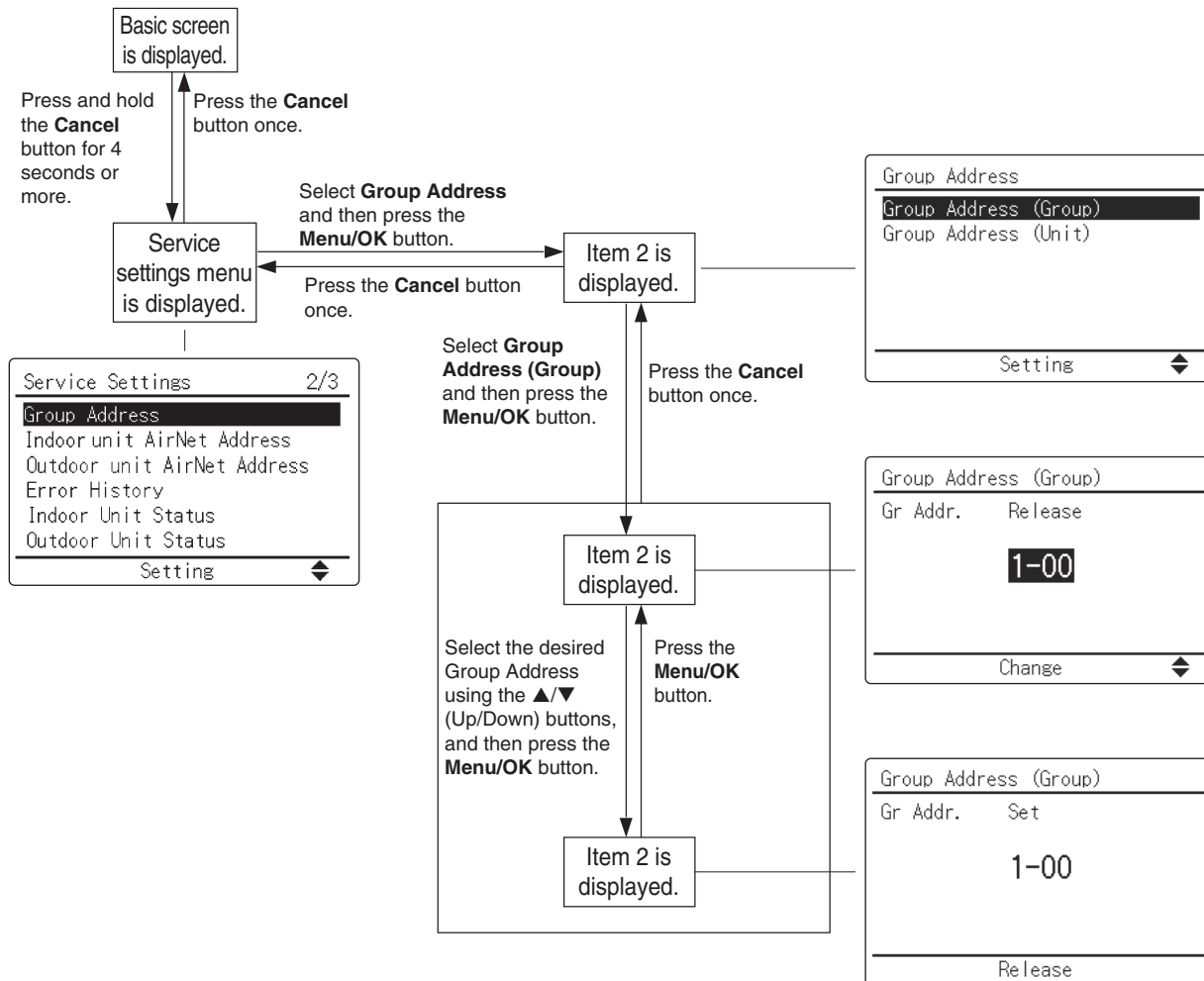

## 5.2 BRC1H71W

### Group Address

- Assign the group address and unit number for centralized control.
- The group and unit address can only be set when a centralized controller is connected.  
This menu is only visible when a centralized controller is connected.
- The group and unit address can be “set” and “released”.

### NOTICE

Don't forget to release the group address before disconnecting the centralized controller because the menu will not be accessible afterwards.

#### Manual setting mode

- Installer setting
- RC settings
- Maintenance

#### Group address setting Main

Set the indoor unit group address.  
After all settings are complete, press the “Send to RC” button.

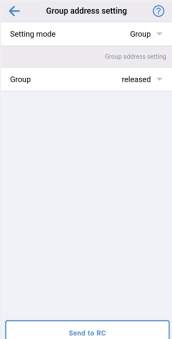

#### Manual setting mode

- Installer setting
- RC settings
- Maintenance

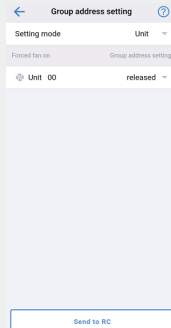

▶ **Setting mode**  
You can switch between setting the indoor unit group address for each group, or for each unit.

#### Manual setting mode

- Installer setting
- RC settings
- Maintenance

▶ **Group**  
Set the group address on a per-group basis.  
\* Set a group address only for the MAIN unit.

▶ **Unit**  
Set the group address on a per-unit basis.

▶ **Forced fan on**  
Force operation of the fan of the unit number whose icon has been tapped. You can confirm the location of the device on which you are performing settings.

## 5.3 Wireless Remote Controller

Group No. setting by wireless remote controller for centralized control

1. When in the normal mode, press **INSPECTION/TEST** button for 4 seconds or more to enter field setting mode.
2. Set mode No. 00 with **MODE** button.
3. Set the group No. for each group with **UP** button or **DOWN** button.
4. Enter the selected group numbers by pressing **RESERVE** button.

5. Press **INSPECTION/TEST** button and return to the normal mode.

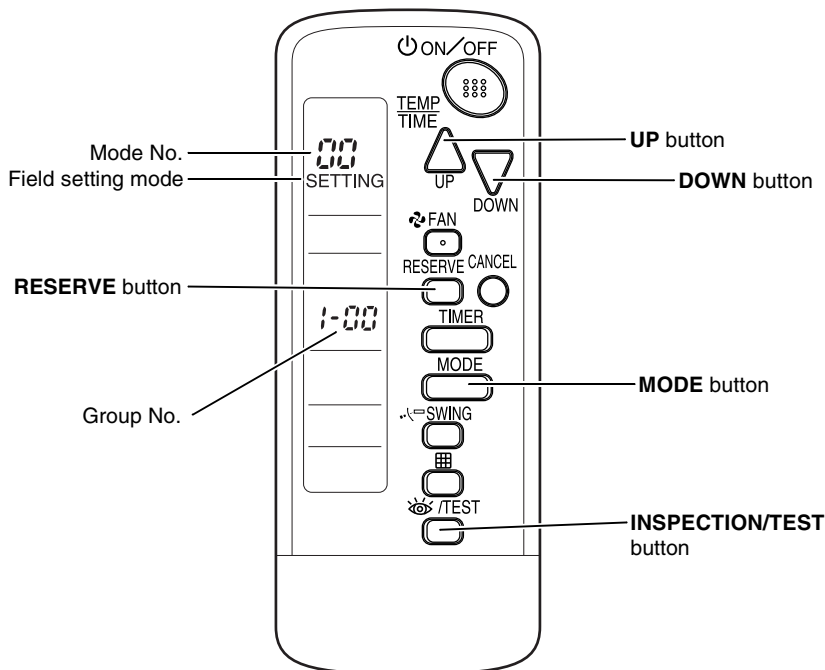

### 5.4 Group No. Setting Example

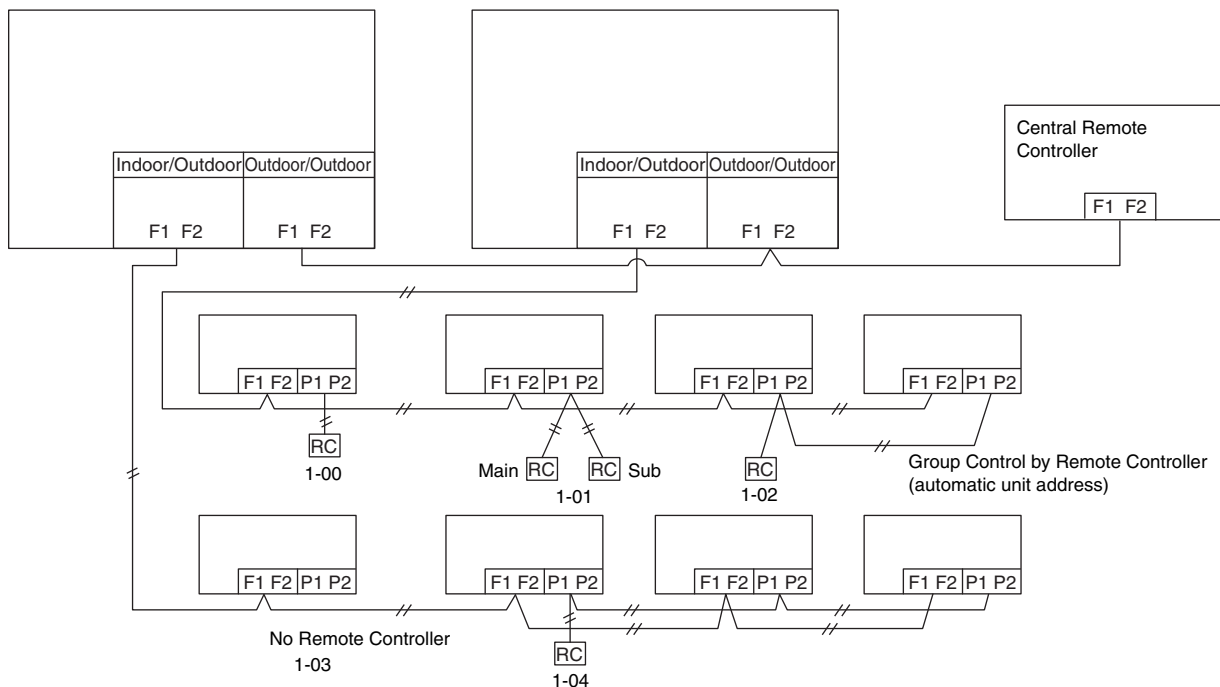

**Caution**

When turning the power supply on, the unit may often not accept any operation while **88** is displaying after all indications were displayed once for about 1 minute on the liquid crystal display. This is not an operative fault.

# 6. Service Settings Menu, Maintenance Menu

## 6.1 BRC1E73

Operating the remote controller allows service data to be acquired and various services to be set.

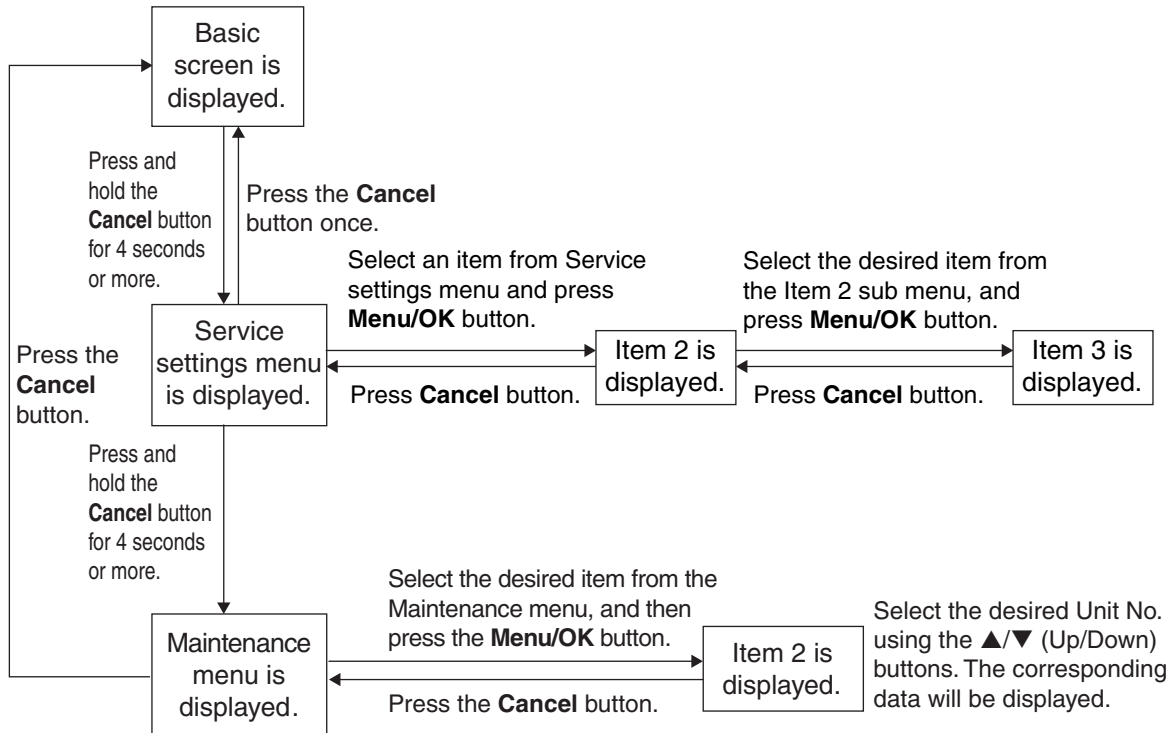

## 6.1.1 Service Settings Menu

Service settings menu	Item 2	Remarks
Test Operation	—	—
Maintenance Contact	None	—
	Maintenance Contact	—, 0 to 9 (in order)
Field Settings	Indoor Unit No.	—
	Mode No.	—
	First Code No.	—
	Second Code No.	—
Energy Saving Options	Setpoint Range Limitation	Temperature
	Setback Configuration	Recovery Differential
	Auto-setback by Sensor	Enable/Disable, Settings
	Auto-off by Sensor	Enable/Disable, Auto-off in (hours)
Prohibit Function	Prohibit Buttons	Up/Down, Left, Right, On/Off, Mode, Fan Speed
	Prohibit Mode	Fan, Cool, Heat, Auto, Dry, Vent Clean
Min setpoints Differential	None, Single SP, 0 to 8°F	—
Group Address	Group Address (Group)	Gr Addr. Set
	Group Address (Unit)	Unit No., Gr Addr. Set
Indoor unit Airnet Address	Unit No., Address Set	—
Outdoor unit Airnet Address	Unit No., Address Set	—
Error History	RC Error History	Unit No., Error, Date, Time (Up to 10 errors received by the remote controller can be displayed.)
	Indoor Unit Error History	Unit No., Error, Date, Time (Up to 5 errors from the indoor unit error record can be displayed.)
Indoor Unit Status	Unit No.	—
	Th1	Suction air thermistor
	Th2	Heat exchanger liquid pipe thermistor
	Th3	Heat exchanger gas pipe thermistor
	Th4	Discharge air thermistor
	Th5	Remote controller thermistor (FXSQ-TA, FXSQ-TB, FXMQ-TB, FXTQ-TA, FXTQ-TB, CXTQ-TA) Floor temperature thermistor (FXFQ-AA, FXFQ-T, FXZQ-TA, FXZQ-TB, FXUQ-P, FXUQ-PA, FXEQ-P)
Outdoor Unit Status	Unit No.	—
	Th1	—
	Th2	—
	Th3	—
	Th4	—
	Th5	—
	Th6	—
Forced Fan ON	Unit No.	—
Switch Main Sub controller	—	—
Filter Indicator	—	—
Test Filter Auto Clean	—	—
Brush / Filter Ind	—	—
Disable Filter Auto Clean	No, Yes	—

## 6.1.2 Maintenance Menu

Maintenance Menu	Item 2	Remarks	
Model Name	Unit No.	Select the unit number you want to check.	
	Indoor unit	The model names are displayed. (A model code may be displayed instead, depending on the particular model.)	
	Outdoor unit		
Operation Hours	Unit No.	Select the unit number you want to check.	
	Indoor unit operation hours	All of these are displayed in hours.	
	Indoor fan operation hours		
	Indoor unit energized hours		
	Outdoor unit operation hours		
	Outdoor fan 1 operation hours		
	Outdoor fan 2 operation hours		
	Outdoor compressor 1 operation hours		
	Outdoor compressor 2 operation hours		
	Indoor Unit Status		Unit No.
FAN			Fan tap (*1)
Speed		Fan speed (rpm) (*2)	
FLAP		Swing, fixed	
EV		Degree that electronic expansion valve is open (pulse)	
MP		Drain pump ON/OFF	
EH		Electric heater ON/OFF	
Hu		Humidifier ON/OFF (*3)	
TBF		Anti-freezing control ON/OFF	
FLOAT		Float switch OPEN/CLOSE	
T1/T2		T1/T2 external input OPEN/CLOSE	
Th1		Suction air thermistor	
Th2		Heat exchanger liquid pipe thermistor	
Th3		Heat exchanger gas pipe thermistor	
Th4		Discharge air thermistor	
Th5		Remote controller thermistor (FXFQ-T, FXSQ-TA, FXSQ-TB, FXMQ-TB, FXTQ-TA, FXTQ-TB, CXTQ-TA) Floor temperature thermistor (FXFQ-AA, FXFQ-T, FXZQ-TA, FXZQ-TB, FXUQ-P, FXUQ-PA, FXEQ-P)	
Th6		Control temperature (FXFQ-AA, FXFQ-T, FXZQ-TA, FXZQ-TB, FXUQ-P, FXUQ-PA, FXEQ-P, FXSQ-TA, FXSQ-TB, FXMQ-TB, FXTQ-TA, FXTQ-TB, CXTQ-TA)	
Outdoor Unit Status		Unit No.	Select the Unit No. you want to check.
		FAN step	Fan tap
		COMP	Compressor power supply frequency (Hz)
	EV1	Degree that electronic expansion valve is open (pulse)	
	SV1	Solenoid valve ON/OFF	
	Th1	—	
	Th2	—	
	Th3	—	
	Th4	—	
	Th5	—	
	Th6	—	

Maintenance Menu	Item 2	Remarks
Forced Defrost	Forced defrost ON	Enables the forced defrost operation.
	Forced defrost OFF	Disables the forced defrost operation.
Error Display	Display error ON	Displays the error on the screen.
	Display error OFF	Displays neither errors nor warnings.
	Display warning ON	Displays a warning on the screen if an error occurs.
	Display warning OFF	No warning is displayed.
Swap Unit No.	Current Unit No.	A unit No. can be transferred to another.
	Transfer Unit No.	
Addressed Sensor Value	Unit No.: 0 - 15	Select the unit number you want to check.
	Code	
	00:	Remote controller thermistor (°C)
	01:	Suction air thermistor (°C)
	02:	Heat exchanger liquid pipe thermistor (°C)
	03:	Heat exchanger gas pipe thermistor (°C)
	04:	Indoor unit address No.
	05:	Outdoor unit address No.
	06:	Branch Selector unit address No.
	07:	Zone control address No.
08:	Cooling/Heating batch address No.	
09:	Demand/low-noise address No.	
30: (*4)	Displays thermostat step 1 ON/OFF. Thermostat step 1 OFF: 00 Thermostat step 1 ON: 01	
31: (*4)( *5)	Displays the heat demand that CXTQ-TA is currently sending to the gas furnace (%).	
32: (*4)( *5)	Displays the fan demand that CXTQ-TA is currently sending to the gas furnace (%).	
33: (*4)	Current status of heat pump ON/OFF for CXTQ-TA HP OFF: 00 HP ON: 01	
34: (*4)( *5)	Current status of gas combustion heating Displays current heat actual status (%).	
35: (*4)( *6)	Current airflow of the fan Displays current airflow (CFM).	
Data	The corresponding data will be displayed, based on the unit number and Code selected.	

- \*1 (For FXTQ-TA, FXTQ-TB, CXTQ-TA models)  
The actual fan speed is converted into the fan tap to be displayed. Therefore, if the fan speed is changed by controls or external factors, the airflow rate set with the remote controller may differ from the fan tap display.
- \*2 (For FXTQ-TA, FXTQ-TB models)  
**0 rpm** is displayed even if the fan is rotating.  
(For CXTQ-TA models)  
**- rpm** is displayed even if the fan is rotating.
- \*3 (For FXTQ-TA, FXTQ-TB, CXTQ-TA models)  
The ON/OFF status of the humidifier connected to HUMIDIFIER on the X1M terminal of the indoor unit PCB is not displayed. The ON/OFF status of the humidifier connected to the wiring adaptor is displayed.
- \*4 Only for CXTQ-TA
- \*5 Displays **99** when it is more than 100%.
- \*6 Display unit is by 100 CFM.  
(ex. Displays **19** for 1850 CFM. Displays **18** for 1849 CFM.)

## **7. Administrator Menu, Installer Menu**

### **7.1 BRC1H71W**

Refer to page 119 for details.



# Part 4

## Functions and Control

1. Operation Flowchart.....	144
2. Stop Control .....	145
2.1 Stop due to Error.....	145
2.2 When System is in Stop Control.....	145
2.3 Sub Unit Stops during Master Unit Control .....	145
3. Standby Control .....	146
3.1 Restart Standby.....	146
3.2 Crankcase Heater Control.....	146
4. Startup Control .....	147
4.1 Startup Control in Cooling .....	148
4.2 Startup Control in Heating.....	148
5. Basic Control.....	149
5.1 Normal Control .....	149
5.2 Compressor PI Control.....	150
5.3 Compressor Step Control.....	151
5.4 Electronic Expansion Valve PI Control.....	155
5.5 Step Control of Outdoor Fans .....	156
5.6 Heat Exchanger Control .....	158
6. Protection Control .....	159
6.1 High Pressure Protection Control.....	159
6.2 Low Pressure Protection Control.....	161
6.3 Discharge Pipe Protection Control .....	162
6.4 Inverter Protection Control .....	163
7. Special Control.....	165
7.1 Pump Down Residual Operation .....	165
7.2 Oil Return Operation .....	166
7.3 Defrost Operation .....	169
7.4 Outdoor Unit Rotation.....	172
7.5 Cooling/Heating Mode Switching .....	173
8. Other Control.....	176
8.1 Backup Operation.....	176
8.2 Demand Operation .....	176
8.3 Heating Operation Prohibition .....	176
9. Outline of Control (Indoor Unit) .....	177
9.1 Operation Flowchart.....	177
9.2 Set Temperature and Control Target Temperature.....	181
9.3 Remote Controller Thermistor .....	183
9.4 Thermostat Control.....	185

---

9.5	Drain Pump Control.....	188
9.6	Control of Electronic Expansion Valve .....	190
9.7	Freeze-Up Prevention Control.....	191
9.8	List of Swing Flap Operations .....	193
9.9	Hot Start Control (In Heating Operation Only).....	194
9.10	Louver Control for Preventing Ceiling Dirt.....	195
9.11	Heater Control (Except FXTQ-TA, FXTQ-TB Models) .....	196
9.12	Heater Control (FXTQ-TA, FXTQ-TB Models) .....	197
9.13	Gas Furnace Control (CXTQ-TA Models) .....	200
9.14	3-Step Thermostat Processing (FXTQ-TA, FXTQ-TB Models) .....	201
9.15	Fan Control (Heater Residual) (FXTQ-TA, FXTQ-TB Models).....	202
9.16	Interlocked with External Equipment (FXTQ-TA, FXTQ-TB, CXTQ-TA Models).....	202

# 1. Operation Flowchart

For detailed description of each function in the flow below, refer to the details on related function on the following pages.

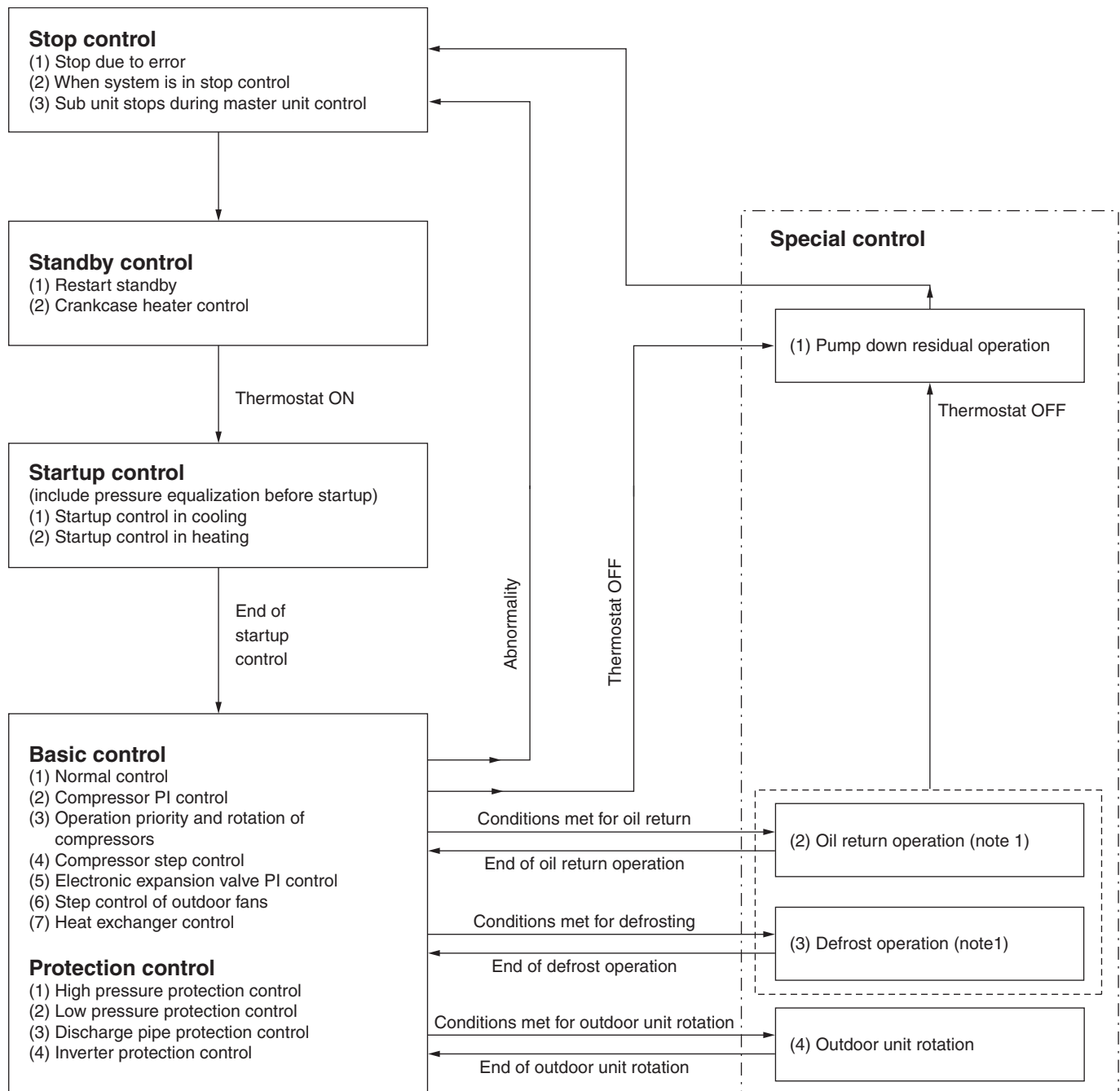

## Note(s)

1. If the indoor unit stops or the thermostat turns OFF while in oil return operation or defrost operation, pump down residual operation is performed on completion of the oil return operation or defrost operation.

## 2. Stop Control

### 2.1 Stop due to Error

In order to protect compressors, if any of the abnormal state occurs, the system will stop with thermostat OFF and the error will be determined when the retry times reaches certain number. (Refer to **Error Codes and Descriptions** on page 297 of the troubleshooting for the items to determine the error.)

### 2.2 When System is in Stop Control

The four way valves retain the condition (ON) when heating operation is stopped.

### 2.3 Sub Unit Stops during Master Unit Control

When sub unit is stopped (because of low demand), conditions for this units are set same as system stop. System stops until this unit is required to operate (increase of load).

## 3. Standby Control

### 3.1 Restart Standby

Used to forcedly stop the compressor for a period of 2 minutes, in order to prevent the frequent ON/OFF of the compressor and equalize the pressure within the refrigerant system.

In addition, the outdoor fan carry out the residual operation for a while to accelerate pressure equalizing and to suppress migration of the refrigerant to the evaporator.

### 3.2 Crankcase Heater Control

In order to prevent the refrigerant from migrating into the compressor oil while not operating, outdoor air temperature, compressor body temperature, etc., are used to control the crankcase heater.

## 4. Startup Control

This control is used to equalize the pressure in the suction and discharge sides of the compressor prior to the startup of the compressor, thus reducing startup loads. Furthermore, the inverter is turned ON to charge the capacitor.

To avoid stresses to the compressor due to liquid refrigerant return or else after the startup, the following control is made and the position of the four way valve is also determined. Start both the master and the sub units simultaneously to position the four way valve.

DSH: Discharge pipe superheating degree

Pc: High pressure sensor detection value

Pe: Low pressure sensor detection value

Ta: Outdoor air temperature

## 4.1 Startup Control in Cooling

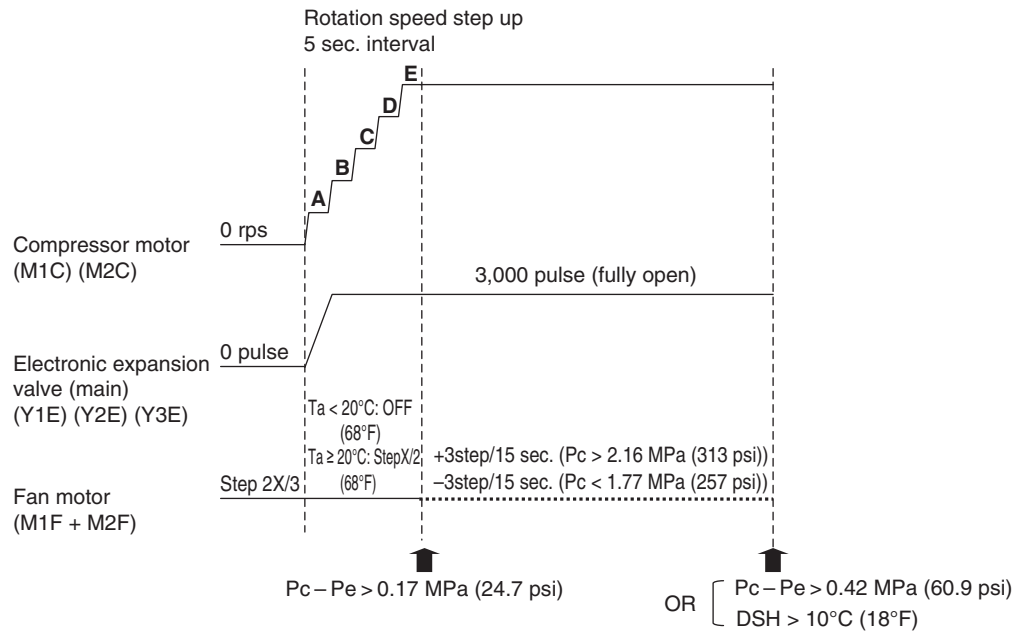

## 4.2 Startup Control in Heating

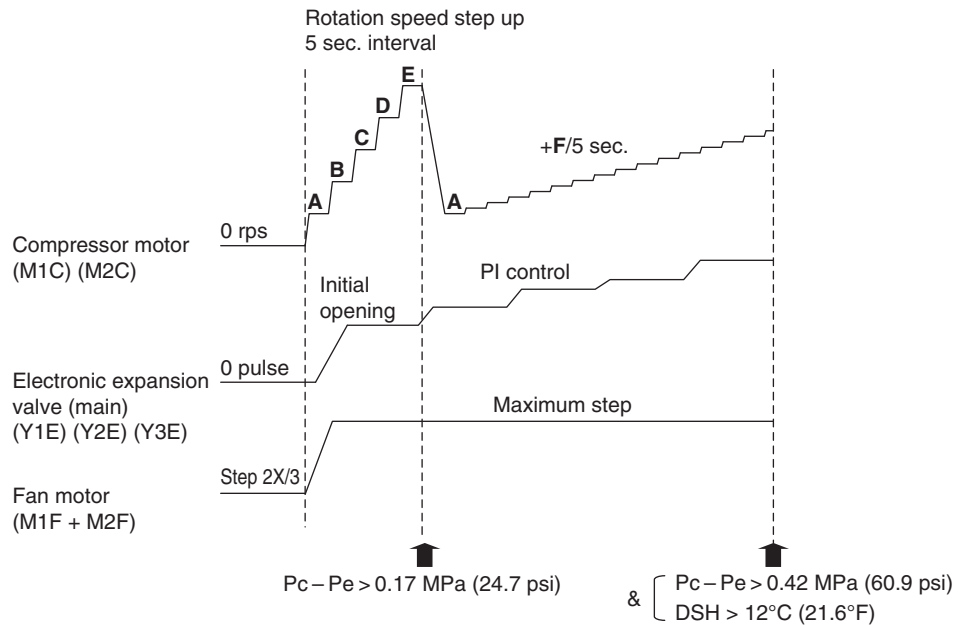

Frequency (rps)	REYQ72AA	REYQ96/120AA		REYQ144/168AA		REYQ192/216/240AA	
		M1C	M2C	M1C	M2C	M1C	M2C
A	15	26	26	26	15	15	15
B	23	37	37	37	23	23	23
C	28	45	45	45	28	28	28
D	37.3	60	60	60	37.3	37.3	37.3
E	51.4	82	82	82	51.4	51.4	51.4
F	0.9	0.8	0.8	0.8	0.5	0.5	0.5



Reference Refer to page 156 for Step X.

## 5. Basic Control

### 5.1 Normal Control

Part name	Electric symbol	Function		
		Normal cooling	Normal heating	Normal simultaneous cooling/heating
Compressor motor	M1C, M2C	PI control, High pressure protection, Low pressure protection, Td protection, Inverter protection	PI control, High pressure protection, Low pressure protection, Td protection, Inverter protection	PI control, High pressure protection, Low pressure protection, Td protection, Inverter protection
Fan motor	M1F, M2F	Cooling fan control	Maximum step	Outdoor heat exchanger: Condenser / Cooling fan control Outdoor heat exchanger: Evaporator / Maximum step
Electronic expansion valve (Heat exchanger right upper)	Y1E	Subcooling degree control	Superheating degree control (Subcooling degree control in low load)	Subcooling degree control (when HE is condenser) Superheating degree control (when HE is evaporator)
Electronic expansion valve (Heat exchanger right lower)	Y2E	Subcooling degree control (0 pulse in low load)	Superheating degree control (0 pulse in low load)	
Electronic expansion valve (Heat exchanger left)	Y5E			
Electronic expansion valve (Subcooling heat exchanger)	Y3E	Superheating degree control (discharge pipe protection)	Superheating degree control (discharge pipe protection)	Superheating degree control (discharge pipe protection)
Electronic expansion valve (Refrigerant cooling IPM)	Y6E	Cooling refrigerant control	Cooling refrigerant control	Cooling refrigerant control
Electronic expansion valve (Refrigerant cooling air)	Y7E			
Electronic expansion valve (Receiver gas purge)	Y4E	0 pulse	Gas purge control	Gas purge control
Solenoid valve (Oil separator oil return)	Y1S, Y2S	ON	ON	ON
Solenoid valve (Liquid shutoff)	Y3S	ON	ON	ON
Solenoid valve (Accumulator oil return)	Y4S	ON	ON	ON
Solenoid valve (Refrigerant adjustment)	Y5S	OFF	OFF	OFF
Solenoid valve (Injection)	Y6S	Compressor injection control	Compressor injection control	Compressor injection control
Four way valve (Heat exchanger right lower)	Y7S	OFF (ON in low load)	ON	OFF (In cooling) ON (In heating)
Four way valve (HP/LP gas pipe)	Y8S	ON	OFF	OFF
Four way valve (Heat exchanger left)	Y9S	OFF (ON in low load)	ON	OFF (In cooling) ON (In heating)
Four way valve (Heat exchanger right upper)	Y10S	OFF	ON (OFF in low load)	OFF (In cooling) ON (In heating)
Solenoid valve (Refrigerant cooling bypass)	Y11S	Cooling refrigerant control	OFF	OFF



Branch Selector unit actuator			Normal cooling	Normal simultaneous cooling/heating		Normal heating
				Cooling	Heating	
Electronic expansion valve (EVSC)	Y1E	Thermostat ON	0 pulse	0 pulse	Subcooling degree control	0 pulse
		Non-operating	0 pulse	0 pulse	0 pulse	0 pulse
		Thermostat OFF	0 pulse	0 pulse	0 pulse	0 pulse
Electronic expansion valve (EVH)	Y2E	Thermostat ON	6,000 pulse	0 pulse	6,000 pulse	6,000 pulse
		Non-operating	6,000 pulse	0 pulse	6,000 pulse	6,000 pulse
		Thermostat OFF	6,000 pulse	0 pulse	6,000 pulse	6,000 pulse
Electronic expansion valve (EVL)	Y3E	Thermostat ON	6,000 pulse	6,000 pulse	0 pulse	0 pulse
		Non-operating	6,000 pulse	6,000 pulse	0 pulse	0 pulse
		Thermostat OFF	6,000 pulse	6,000 pulse	0 pulse	0 pulse

## 5.2 Compressor PI Control

Carries out the compressor capacity PI control so that  $T_e$  reaches the target value during cooling and  $T_c$  during heating.

### Cooling

Controls compressor capacity to adjust  $T_e$  to achieve target value ( $T_{eS}$ ).

- VRT control (default)  
When the indoor temperature approaches the set temperature in all indoor units and the required capacity decreases,  $T_{eS}$  is automatically increased to adjust the capacity.
- Constant control  
 $T_{eS}$  is fixed to the set value.

#### $T_e$ setting

L	M	H				
3°C (37.4°F)	6°C (42.8°F)	7°C (44.6°F)	8°C (46.4°F)	9°C (48.2°F)	10°C (50.0°F)	11°C (51.8°F)

$T_e$ : Low pressure equivalent saturation temperature

$T_{eS}$ : Target temperature of  $T_e$  (Varies depending on  $T_e$  setting, operating frequency, etc.)

### Heating

Controls compressor capacity to adjust  $T_c$  to achieve target value ( $T_{cS}$ ).

- VRT control (default)  
When the indoor temperature approaches the set temperature in all indoor units and the required capacity decreases,  $T_{cS}$  is automatically decreased to adjust the capacity.
- Constant control  
 $T_{cS}$  is fixed to the set value.

#### $T_c$ setting

L					M	H
41°C (105.8°F)	42°C (107.6°F)	43°C (109.4°F)	44°C (111.2°F)	45°C (113.0°F)	46°C (114.8°F)	48°C (118.4°F)

$T_c$ : High pressure equivalent saturation temperature

$T_{cS}$ : Target temperature of  $T_c$  (Varies depending on  $T_c$  setting, operating frequency, etc.)

## 5.3 Compressor Step Control

The compressor operation varies in the following steps according to information in Compressor PI Control. Refer to page 150.

Depending on the operating conditions of compressors, the compressors may run in patterns other than the following.

### REYQ72AA

Step No.	rps
1	15.0
2	15.2
3	15.4
4	15.6
5	15.9
6	16.2
7	16.5
8	16.8
9	17.1
10	17.4
11	17.7
12	18.0
13	18.3
14	18.6
15	19.0
16	19.4
17	19.8
18	20.1
19	20.5
20	20.7
21	21.0
22	21.3
23	21.6
24	21.9
25	22.2
26	22.5
27	22.9
28	23.2
29	23.5
30	23.8
31	24.2
32	24.5
33	24.9
34	25.2
35	25.5
36	25.9
37	26.3
38	26.6
39	27.0
40	27.4
41	27.8
42	28.1
43	28.5
44	29.0
45	29.4
46	29.8
47	30.2
48	30.6
49	31.0
50	31.5
51	31.9
52	32.4
53	32.8
54	33.3
55	33.8
56	34.2
57	34.7
58	35.2
59	35.7
60	36.2
61	36.7
62	37.2
63	37.7
64	38.3
65	38.8
66	39.3

Step No.	rps
67	39.9
68	40.5
69	41.0
70	41.6
71	42.2
72	42.8
73	43.4
74	44.0
75	44.6
76	45.2
77	45.8
78	46.5
79	47.1
80	47.8
81	48.5
82	49.1
83	49.8
84	50.5
85	51.2
86	52.0
87	52.7
88	53.4
89	54.2
90	54.9
91	55.7
92	56.5
93	57.3
94	58.1
95	58.9
96	59.7
97	60.5
98	61.4
99	62.3
100	63.1
101	64.0
102	64.9
103	65.8
104	66.8
105	67.7
106	68.6
107	69.6
108	70.6
109	71.6
110	72.6
111	73.6
112	74.6
113	75.7
114	76.7
115	77.8
116	78.9
117	80.0
118	81.1
119	82.2
120	83.4
121	84.5
122	85.7
123	86.9
124	88.1
125	89.4
126	90.6
127	91.9
128	93.2
129	94.5
130	95.8
131	95.8
132	97.2

Step No.	rps
133	97.2
134	102.7
135	102.7
136	104.2
137	105.6
138	107.1
139	108.6
140	110.1
141	111.7
142	113.2
143	114.8
144	116.4
145	118.0
146	119.7
147	121.4
148	123.1
149	124.8
150	127.3

←REYQ72AA Heating upper limit

←REYQ72AA Cooling upper limit

**REYQ96/120AA**

Step No.	Step up (rps)		Step down (rps)		Step No.	Step up (rps)		Step down (rps)		Step No.	Step up (rps)		Step down (rps)	
	M1C	M2C	M1C	M2C		M1C	M2C	M1C	M2C		M1C	M2C	M1C	M2C
1	15.0	0.0	29.7	0.0	76	47.6	0.0	22.5	25.1	151	135.2	0.0	63.9	71.3
2	15.3	0.0	29.7	0.0	77	48.3	0.0	22.8	25.5	152	137.1	0.0	64.8	72.3
3	15.7	0.0	29.7	0.0	78	49.0	0.0	23.1	25.8	153	139.0	0.0	65.7	73.3
4	16.0	0.0	29.7	0.0	79	49.7	0.0	23.5	26.2	154	140.0	0.0	65.6	74.4
5	16.4	0.0	29.7	0.0	80	50.4	0.0	23.8	26.5	155	66.5	75.4	66.5	75.4
6	16.7	0.0	29.7	0.0	81	51.1	0.0	24.2	26.9	156	67.4	76.5	67.4	76.5
7	17.1	0.0	29.7	0.0	82	51.8	0.0	24.5	27.3	157	68.4	77.5	68.4	77.5
8	17.4	0.0	29.7	0.0	83	52.5	0.0	24.8	27.7	158	69.3	78.6	69.3	78.6
9	17.8	0.0	29.7	0.0	84	53.3	0.0	25.2	28.1	159	70.3	79.7	70.3	79.7
10	18.1	0.0	29.7	0.0	85	54.0	0.0	25.5	28.5	160	71.3	80.8	71.3	80.8
11	18.5	0.0	29.7	0.0	86	54.8	0.0	25.9	28.9	161	72.3	82.0	72.3	82.0
12	18.8	0.0	29.7	0.0	87	55.5	0.0	26.2	29.3	162	73.3	83.1	73.3	83.1
13	19.2	0.0	29.7	0.0	88	56.3	0.0	26.6	29.7	163	74.3	84.3	74.3	84.3
14	19.5	0.0	29.7	0.0	89	57.1	0.0	27.0	30.1	164	75.4	85.5	75.4	85.5
15	19.9	0.0	29.7	0.0	90	57.9	0.0	27.4	30.5	165	76.4	86.7	76.4	86.7
16	20.2	0.0	29.7	0.0	91	58.7	0.0	27.8	30.9	166	77.5	87.9	77.5	87.9
17	20.6	0.0	29.7	0.0	92	59.5	0.0	28.1	31.4	167	78.6	89.1	78.6	89.1
18	20.9	0.0	29.7	0.0	93	60.4	0.0	28.5	31.8	168	79.7	90.4	79.7	90.4
19	21.3	0.0	29.7	0.0	94	61.2	0.0	28.9	32.3	169	80.8	91.6	80.8	91.6
20	21.6	0.0	29.7	0.0	95	62.1	0.0	29.3	32.7	170	81.9	92.9	81.9	92.9
21	22.0	0.0	29.7	0.0	96	62.9	0.0	29.7	33.2	171	83.1	94.2	83.1	94.2
22	22.3	0.0	29.7	0.0	97	63.8	0.0	30.2	33.6	172	84.2	95.5	84.2	95.5
23	22.7	0.0	29.7	0.0	98	64.7	0.0	30.6	34.1	173	85.4	96.9	85.4	96.9
24	23.0	0.0	29.7	0.0	99	65.6	0.0	31.0	34.6	174	86.6	98.2	86.6	98.2
25	23.4	0.0	29.7	0.0	100	66.5	0.0	31.4	35.1	175	87.8	99.6	87.8	99.6
26	23.7	0.0	29.7	0.0	101	67.5	0.0	31.9	35.6	176	89.0	101.0	89.0	101.0
27	24.1	0.0	29.7	0.0	102	68.4	0.0	32.3	36.1	177	90.3	102.4	90.3	102.4
28	24.4	0.0	29.7	0.0	103	69.4	0.0	32.8	36.6	178	91.5	103.9	91.5	103.9
29	24.8	0.0	29.7	0.0	104	70.3	0.0	33.2	37.1	179	92.8	105.3	92.8	105.3
30	25.1	0.0	29.7	0.0	105	71.3	0.0	33.7	37.6	180	94.1	106.8	94.1	106.8
31	25.5	0.0	29.7	0.0	106	72.3	0.0	34.2	38.1	181	95.5	108.3	95.5	108.3
32	25.8	0.0	29.7	0.0	107	73.3	0.0	34.6	38.7	182	96.8	109.8	96.8	109.8
33	26.2	0.0	29.7	0.0	108	74.4	0.0	35.1	39.2	183	98.1	111.3	98.1	111.3
34	26.5	0.0	29.7	0.0	109	75.4	0.0	35.6	39.8	184	99.5	112.9	99.5	112.9
35	26.9	0.0	29.7	0.0	110	76.5	0.0	36.1	40.3	185	100.9	114.5	100.9	114.5
36	27.3	0.0	29.7	0.0	111	77.5	0.0	36.6	40.9	186	102.3	116.1	102.3	116.1
37	27.7	0.0	29.7	0.0	112	78.6	0.0	37.2	41.4	187	103.7	117.7	103.7	117.7
38	28.1	0.0	29.7	0.0	113	79.7	0.0	37.7	42.0	188	105.2	119.4	105.2	119.4
39	28.5	0.0	29.7	0.0	114	80.8	0.0	38.2	42.6	189	106.7	121.0	106.7	121.0
40	28.9	0.0	29.7	0.0	115	82.0	0.0	38.7	43.2	190	108.2	122.7	108.2	122.7
41	29.3	0.0	29.7	0.0	116	83.1	0.0	39.3	43.8	191	109.7	124.4	109.7	124.4
42	29.7	0.0	29.7	0.0	117	84.3	0.0	39.8	44.4	192	111.2	126.2	111.2	126.2
43	30.1	0.0	15.0	15.0	118	85.5	0.0	40.4	45.0	193	112.8	127.9	112.8	127.9
44	30.5	0.0	15.2	15.3	119	86.7	0.0	41.0	45.7	194	114.4	129.7	114.4	129.7
45	30.9	0.0	15.3	15.6	120	87.9	0.0	41.5	46.3	195	116.0	131.5	116.0	131.5
46	31.4	0.0	15.5	15.9	121	89.1	0.0	42.1	47.0	196	117.6	133.4	117.6	133.4
47	31.8	0.0	15.6	16.2	122	90.4	0.0	42.7	47.6	197	119.3	135.2	119.3	135.2
48	32.3	0.0	15.8	16.5	123	91.6	0.0	43.3	48.3	198	120.9	137.1	120.9	137.1
49	32.7	0.0	15.9	16.8	124	92.9	0.0	43.9	49.0					
50	33.2	0.0	16.1	17.1	125	94.2	0.0	44.5	49.7					
51	33.6	0.0	16.2	17.4	126	95.5	0.0	45.1	50.4					
52	34.1	0.0	16.4	17.7	127	96.9	0.0	45.8	51.1					
53	34.6	0.0	16.6	18.0	128	98.2	0.0	46.4	51.8					
54	35.1	0.0	16.8	18.3	129	99.6	0.0	47.1	52.5					
55	35.6	0.0	17.0	18.6	130	101.0	0.0	47.7	53.3					
56	36.1	0.0	17.2	18.9	131	102.4	0.0	48.4	54.0					
57	36.6	0.0	17.4	19.2	132	103.9	0.0	49.1	54.8					
58	37.1	0.0	17.6	19.5	133	105.3	0.0	49.8	55.5					
59	37.6	0.0	17.8	19.8	134	106.8	0.0	50.4	56.3					
60	38.1	0.0	18.0	20.1	135	108.3	0.0	51.1	57.1					
61	38.7	0.0	18.3	20.4	136	109.8	0.0	51.8	57.9					
62	39.2	0.0	18.5	20.7	137	111.3	0.0	52.6	58.7					
63	39.8	0.0	18.8	21.0	138	112.9	0.0	53.3	59.5					
64	40.3	0.0	19.0	21.3	139	114.5	0.0	54.1	60.4					
65	40.9	0.0	19.3	21.6	140	116.1	0.0	54.8	61.2					
66	41.4	0.0	19.5	21.9	141	117.7	0.0	55.6	62.1					
67	42.0	0.0	19.8	22.2	142	119.4	0.0	56.4	62.9					
68	42.6	0.0	20.1	22.5	143	121.0	0.0	57.2	63.8					
69	43.2	0.0	20.4	22.8	144	122.7	0.0	58.0	64.7					
70	43.8	0.0	20.7	23.1	145	124.4	0.0	58.8	65.6					
71	44.4	0.0	21.0	23.4	146	126.2	0.0	59.6	66.5					
72	45.0	0.0	21.3	23.7	147	127.9	0.0	60.4	67.5					
73	45.7	0.0	21.6	24.1	148	129.7	0.0	61.3	68.4					
74	46.3	0.0	21.9	24.4	149	131.5	0.0	62.1	69.4					
75	47.0	0.0	22.2	24.8	150	133.4	0.0	63.0	70.3					

**REYQ144/168AA**

Step No.	Step up (rps)		Step down (rps)		Step No.	Step up (rps)		Step down (rps)		Step No.	Step up (rps)		Step down (rps)	
	M1C	M2C	M1C	M2C		M1C	M2C	M1C	M2C		M1C	M2C	M1C	M2C
1	15.0	0.0	15.0	0.0	76	48.9	0.0	19.1	18.5	151	58.8	53.8	58.8	53.8
2	15.3	0.0	15.3	0.0	77	49.6	0.0	19.5	18.8	152	59.6	54.6	59.6	54.6
3	15.7	0.0	15.7	0.0	78	50.3	0.0	19.8	19.0	153	60.4	55.4	60.4	55.4
4	16.0	0.0	16.0	0.0	79	51.1	0.0	20.2	19.3	154	61.3	56.3	61.3	56.3
5	16.4	0.0	16.4	0.0	80	51.8	0.0	20.5	19.5	155	62.1	57.1	62.1	57.1
6	16.7	0.0	16.7	0.0	81	52.6	0.0	20.9	19.8	156	63.0	58.0	63.0	58.0
7	17.1	0.0	17.1	0.0	82	53.3	0.0	21.2	20.0	157	63.8	58.8	63.8	58.8
8	17.4	0.0	17.4	0.0	83	54.1	0.0	21.6	20.3	158	64.7	59.7	64.7	59.7
9	17.8	0.0	17.8	0.0	84	54.9	0.0	21.9	20.5	159	65.6	60.6	65.6	60.6
10	18.1	0.0	18.1	0.0	85	55.7	0.0	22.3	20.8	160	66.5	61.5	66.5	61.5
11	18.5	0.0	18.5	0.0	86	56.5	0.0	22.7	21.1	161	67.5	62.5	67.5	62.5
12	18.8	0.0	18.8	0.0	87	57.3	0.0	23.1	21.4	162	68.4	63.4	68.4	63.4
13	19.2	0.0	19.2	0.0	88	58.2	0.0	23.4	21.6	163	69.4	64.4	69.4	64.4
14	19.5	0.0	19.5	0.0	89	59.0	0.0	23.8	21.9	164	70.3	65.3	70.3	65.3
15	19.9	0.0	19.9	0.0	90	59.9	0.0	24.2	22.2	165	71.3	66.3	71.3	66.3
16	20.2	0.0	20.2	0.0	91	60.7	0.0	24.6	22.5	166	72.3	67.3	72.3	67.3
17	20.6	0.0	20.6	0.0	92	61.6	0.0	25.0	22.8	167	73.3	68.3	73.3	68.3
18	20.9	0.0	20.9	0.0	93	62.5	0.0	25.4	23.1	168	74.3	69.3	74.3	69.3
19	21.3	0.0	21.3	0.0	94	63.4	0.0	25.8	23.4	169	75.4	70.4	75.4	70.4
20	21.6	0.0	21.6	0.0	95	64.4	0.0	26.3	23.8	170	76.4	71.4	76.4	71.4
21	22.0	0.0	22.0	0.0	96	65.3	0.0	26.7	24.1	171	77.5	72.5	77.5	72.5
22	22.3	0.0	22.3	0.0	97	66.3	0.0	27.1	24.4	172	78.6	73.6	78.6	73.6
23	22.7	0.0	22.7	0.0	98	67.2	0.0	27.5	24.7	173	79.7	74.7	79.7	74.7
24	23.0	0.0	23.0	0.0	99	68.2	0.0	28.0	25.1	174	80.8	75.8	80.8	75.8
25	23.4	0.0	23.4	0.0	100	69.2	0.0	28.4	25.4	175	81.9	76.9	81.9	76.9
26	23.7	0.0	23.7	0.0	101	70.2	0.0	28.9	25.8	176	83.1	78.1	83.1	78.1
27	24.1	0.0	24.1	0.0	102	71.2	0.0	29.3	26.1	177	84.3	79.3	84.3	79.3
28	24.4	0.0	24.4	0.0	103	72.3	0.0	29.8	26.5	178	85.4	80.4	85.4	80.4
29	24.8	0.0	24.8	0.0	104	73.3	0.0	30.3	26.9	179	86.7	81.7	86.7	81.7
30	25.1	0.0	25.1	0.0	105	74.4	0.0	30.7	27.2	180	87.9	82.9	87.9	82.9
31	25.5	0.0	25.5	0.0	106	75.5	0.0	31.2	27.6	181	89.1	84.1	89.1	84.1
32	25.8	0.0	25.8	0.0	107	76.6	0.0	31.7	28.0	182	90.4	85.4	90.4	85.4
33	26.2	0.0	26.2	0.0	108	77.7	0.0	32.2	28.4	183	91.6	86.6	91.6	86.6
34	26.6	0.0	26.6	0.0	109	78.8	0.0	32.7	28.8	184	92.9	87.9	92.9	87.9
35	27.0	0.0	27.0	0.0	110	80.0	0.0	33.2	29.2	185	94.2	89.2	94.2	89.2
36	27.4	0.0	27.4	0.0	111	81.1	0.0	33.7	29.6	186	95.6	90.6	95.6	90.6
37	27.8	0.0	27.8	0.0	112	82.3	0.0	34.2	30.0	187	96.9	91.9	96.9	91.9
38	28.2	0.0	28.2	0.0	113	83.5	0.0	34.7	30.4	188	98.3	93.3	98.3	93.3
39	28.6	0.0	28.6	0.0	114	84.7	0.0	35.3	30.9	189	99.7	94.7	99.7	94.7
40	29.0	0.0	29.0	0.0	115	86.0	0.0	35.8	31.3	190	101.1	96.1	101.1	96.1
41	29.4	0.0	29.4	0.0	116	87.2	0.0	36.3	31.7	191	102.5	97.5	102.5	97.5
42	29.9	0.0	29.9	0.0	117	88.5	0.0	36.9	32.2	192	104.0	99.0	104.0	99.0
43	30.3	0.0	30.3	0.0	118	89.8	0.0	37.4	32.6	193	105.4	100.4	105.4	100.4
44	30.8	0.0	30.8	0.0	119	91.1	0.0	38.0	33.1	194	106.9	101.9	106.9	101.9
45	31.2	0.0	31.2	0.0	120	92.4	0.0	38.6	33.6	195	108.4	103.4	108.4	103.4
46	31.7	0.0	31.7	0.0	121	93.8	0.0	39.1	34.1	196	110.0	105.0	110.0	105.0
47	32.1	0.0	32.1	0.0	122	95.1	0.0	39.6	34.6	197	111.5	106.5	111.5	106.5
48	32.6	0.0	32.6	0.0	123	96.5	0.0	40.2	35.2	198	113.1	108.1	113.1	108.1
49	33.1	0.0	33.1	0.0	124	97.9	0.0	40.7	35.7	199	114.7	109.7	114.7	109.7
50	33.6	0.0	33.6	0.0	125	99.4	0.0	41.3	36.3	200	116.4	111.4	116.4	111.4
51	34.1	0.0	34.1	0.0	126	100.8	0.0	41.8	36.8	201	118.0	113.0	118.0	113.0
52	34.6	0.0	34.6	0.0	127	102.3	0.0	42.4	37.4	202	119.7	114.7	119.7	114.7
53	35.1	0.0	35.1	0.0	128	103.8	0.0	43.0	38.0	203	121.4	116.4	121.4	116.4
54	35.6	0.0	35.6	0.0	129	105.3	0.0	43.5	38.5	204	123.1	118.1	123.1	118.1
55	36.1	0.0	36.1	0.0	130	106.8	0.0	44.1	39.1	205	124.9	119.9	124.9	119.9
56	36.6	0.0	36.6	0.0	131	108.4	0.0	44.7	39.7	206	126.6	121.6	126.6	121.6
57	37.2	0.0	37.2	0.0	132	110.0	0.0	45.3	40.3	207	128.4	123.4	128.4	123.4
58	37.7	0.0	37.7	0.0	133	111.6	0.0	46.0	41.0	208	130.3	125.3	130.3	125.3
59	38.3	0.0	38.3	0.0	134	113.2	0.0	46.6	41.6	209	132.1	127.1	132.1	127.1
60	38.8	0.0	15.0	15.0	135	114.9	0.0	47.2	42.2	210	134.0	129.0	134.0	129.0
61	39.4	0.0	15.1	15.1	136	116.6	0.0	47.9	42.9	211	135.9	130.9	135.9	130.9
62	39.9	0.0	15.3	15.3	137	118.3	0.0	48.5	43.5	212	137.9	132.9	137.9	132.9
63	40.5	0.0	15.5	15.5	138	120.0	0.0	49.2	44.2	213	140.0	134.8	140.0	134.8
64	41.1	0.0	15.8	15.8	139	121.8	0.0	49.9	44.9	214	140.0	140.0	140.0	140.0
65	41.7	0.0	16.0	16.0	140	123.6	0.0	50.6	45.6					
66	42.3	0.0	16.2	16.2	141	125.4	0.0	51.3	46.3					
67	42.9	0.0	16.5	16.5	142	127.2	0.0	52.0	47.0					
68	43.6	0.0	16.7	16.7	143	129.1	0.0	52.7	47.7					
69	44.2	0.0	17.0	17.0	144	131.0	0.0	53.4	48.4					
70	44.9	0.0	17.2	17.2	145	132.9	0.0	54.1	49.1					
71	45.5	0.0	17.5	17.4	146	134.8	0.0	54.9	49.9					
72	46.2	0.0	17.8	17.6	147	136.8	0.0	55.6	50.6					
73	46.8	0.0	18.2	17.9	148	138.8	0.0	56.4	51.4					
74	47.5	0.0	18.5	18.1	149	140.0	0.0	57.2	52.2					
75	48.2	0.0	18.8	18.3	150	58.0	53.0	58.0	53.0					

**REYQ192/216/240AA**

Step No.	Step up (rps)		Step down (rps)		Step No.	Step up (rps)		Step down (rps)		Step No.	Step up (rps)		Step down (rps)	
	M1C	M2C	M1C	M2C		M1C	M2C	M1C	M2C		M1C	M2C	M1C	M2C
1	15.0	0.0	15.0	0.0	76	43.0	0.0	19.0	24.0	151	122.2	0.0	58.5	63.6
2	15.2	0.0	15.2	0.0	77	43.6	0.0	19.2	24.4	152	123.9	0.0	59.4	64.4
3	15.4	0.0	15.4	0.0	78	44.3	0.0	19.5	24.7	153	125.6	0.0	60.3	65.3
4	15.6	0.0	15.6	0.0	79	44.9	0.0	19.9	24.9	154	127.4	0.0	61.2	66.2
5	15.8	0.0	15.8	0.0	80	45.5	0.0	20.2	25.2	155	129.2	0.0	62.0	67.1
6	16.0	0.0	16.0	0.0	81	46.1	0.0	20.5	25.5	156	131.0	0.0	63.0	68.0
7	16.3	0.0	16.3	0.0	82	46.8	0.0	20.9	25.9	157	132.8	0.0	63.9	68.9
8	16.5	0.0	16.5	0.0	83	47.5	0.0	21.2	26.2	158	134.7	0.0	64.8	69.8
9	16.7	0.0	16.7	0.0	84	48.1	0.0	21.5	26.5	159	136.6	0.0	65.8	70.8
10	17.0	0.0	17.0	0.0	85	48.8	0.0	21.9	26.9	160	138.5	0.0	66.7	71.7
11	17.2	0.0	17.2	0.0	86	49.5	0.0	22.2	27.2	161	140.0	0.0	67.5	72.5
12	17.5	0.0	17.5	0.0	87	50.2	0.0	22.5	27.6	162	68.4	73.5	68.4	73.5
13	18.0	0.0	18.0	0.0	88	50.9	0.0	22.9	27.9	163	69.4	74.5	69.4	74.5
14	18.2	0.0	18.2	0.0	89	51.6	0.0	23.3	28.3	164	70.4	75.5	70.4	75.5
15	18.5	0.0	18.5	0.0	90	52.3	0.0	23.6	28.6	165	71.4	76.5	71.4	76.5
16	18.7	0.0	18.7	0.0	91	53.0	0.0	24.0	29.0	166	72.5	77.5	72.5	77.5
17	19.0	0.0	19.0	0.0	92	53.8	0.0	24.4	29.4	167	73.5	78.5	73.5	78.5
18	19.2	0.0	19.2	0.0	93	54.5	0.0	24.7	29.7	168	74.6	79.6	74.6	79.6
19	19.5	0.0	19.5	0.0	94	55.3	0.0	25.1	30.1	169	75.7	80.7	75.7	80.7
20	19.8	0.0	19.8	0.0	95	56.0	0.0	25.5	30.5	170	76.8	81.8	76.8	81.8
21	20.1	0.0	20.1	0.0	96	56.8	0.0	25.9	30.9	171	77.9	82.9	77.9	82.9
22	20.4	0.0	20.4	0.0	97	57.6	0.0	26.3	31.3	172	79.0	84.0	79.0	84.0
23	20.6	0.0	20.6	0.0	98	58.4	0.0	26.7	31.7	173	80.1	85.2	80.1	85.2
24	20.9	0.0	20.9	0.0	99	59.2	0.0	27.1	32.1	174	81.3	86.3	81.3	86.3
25	21.2	0.0	21.2	0.0	100	60.1	0.0	27.5	32.5	175	82.5	87.5	82.5	87.5
26	21.5	0.0	21.5	0.0	101	60.9	0.0	27.9	33.0	176	83.7	88.7	83.7	88.7
27	21.8	0.0	21.8	0.0	102	61.8	0.0	28.4	33.4	177	84.9	89.9	84.9	89.9
28	22.1	0.0	22.1	0.0	103	62.6	0.0	28.8	33.8	178	86.1	91.1	86.1	91.1
29	22.5	0.0	22.5	0.0	104	63.5	0.0	29.2	34.2	179	87.4	92.4	87.4	92.4
30	22.8	0.0	22.8	0.0	105	64.4	0.0	29.7	34.7	180	88.6	93.6	88.6	93.6
31	23.1	0.0	23.1	0.0	106	65.3	0.0	30.1	35.1	181	89.9	94.9	89.9	94.9
32	23.4	0.0	23.4	0.0	107	66.2	0.0	30.6	35.6	182	91.2	96.2	91.2	96.2
33	23.7	0.0	23.7	0.0	108	67.1	0.0	31.0	36.0	183	92.5	97.5	92.5	97.5
34	24.1	0.0	24.1	0.0	109	68.1	0.0	31.5	36.5	184	93.8	98.9	93.8	98.9
35	24.4	0.0	24.4	0.0	110	69.0	0.0	32.0	37.0	185	95.1	100.2	95.1	100.2
36	24.8	0.0	24.8	0.0	111	70.0	0.0	32.5	37.5	186	96.5	101.6	96.5	101.6
37	25.1	0.0	25.1	0.0	112	71.0	0.0	33.0	38.0	187	97.9	103.0	97.9	103.0
38	25.5	0.0	25.5	0.0	113	72.0	0.0	33.5	38.5	188	99.3	104.4	99.3	104.4
39	25.8	0.0	25.8	0.0	114	73.0	0.0	34.0	39.0	189	100.7	105.8	100.7	105.8
40	26.2	0.0	26.2	0.0	115	74.0	0.0	34.5	39.5	190	102.2	107.2	102.2	107.2
41	26.5	0.0	26.5	0.0	116	75.0	0.0	35.0	40.0	191	103.7	108.7	103.7	108.7
42	26.9	0.0	26.9	0.0	117	76.1	0.0	35.5	40.5	192	105.2	110.2	105.2	110.2
43	27.3	0.0	27.3	0.0	118	77.2	0.0	36.0	41.1	193	106.6	111.7	106.6	111.7
44	27.7	0.0	27.7	0.0	119	78.3	0.0	36.6	41.6	194	108.2	113.2	108.2	113.2
45	28.0	0.0	28.0	0.0	120	79.4	0.0	37.1	42.2	195	109.7	114.8	109.7	114.8
46	28.5	0.0	28.5	0.0	121	80.5	0.0	37.7	42.7	196	111.3	116.3	111.3	116.3
47	28.9	0.0	28.9	0.0	122	81.6	0.0	38.3	43.3	197	112.9	117.9	112.9	117.9
48	29.3	0.0	29.3	0.0	123	82.8	0.0	38.9	43.9	198	114.5	119.5	114.5	119.5
49	29.7	0.0	29.7	0.0	124	83.9	0.0	39.4	44.5	199	116.1	121.2	116.1	121.2
50	30.0	0.0	15.0	15.0	125	85.1	0.0	40.0	45.0	200	117.8	122.9	117.8	122.9
51	30.4	0.0	15.0	15.3	126	86.3	0.0	40.6	45.6	201	119.5	124.5	119.5	124.5
52	30.8	0.0	15.2	15.6	127	87.5	0.0	41.2	46.2	202	121.2	126.2	121.2	126.2
53	31.2	0.0	15.3	15.9	128	88.7	0.0	41.8	46.9	203	123.0	128.0	123.0	128.0
54	31.7	0.0	15.4	16.2	129	90.0	0.0	42.5	47.5	204	124.7	129.7	124.7	129.7
55	32.1	0.0	15.5	16.5	130	91.2	0.0	43.1	48.1	205	126.5	131.5	126.5	131.5
56	32.5	0.0	15.6	16.9	131	92.5	0.0	43.7	48.7	206	128.3	133.3	128.3	133.3
57	33.0	0.0	15.8	17.2	132	93.8	0.0	44.4	49.4	207	130.1	135.2	130.1	135.2
58	33.5	0.0	15.9	17.5	133	95.1	0.0	45.0	50.0	208	132.0	137.0	132.0	137.0
59	34.0	0.0	16.0	17.9	134	96.5	0.0	45.7	50.7	209	133.9	138.9	133.9	138.9
60	34.4	0.0	16.1	18.2	135	97.8	0.0	46.4	51.4	210	135.0	140.0	135.0	140.0
61	34.9	0.0	16.3	18.6	136	99.2	0.0	47.0	52.1					
62	35.4	0.0	16.4	18.9	137	100.5	0.0	47.7	52.8					
63	35.9	0.0	16.6	19.3	138	102.0	0.0	48.5	53.5					
64	36.4	0.0	16.7	19.6	139	103.4	0.0	49.2	54.2					
65	36.9	0.0	16.9	20.0	140	104.8	0.0	49.9	54.9					
66	37.4	0.0	17.0	20.3	141	106.3	0.0	50.6	55.6					
67	38.0	0.0	17.2	20.7	142	107.8	0.0	51.4	56.4					
68	38.5	0.0	17.4	21.1	143	109.3	0.0	52.1	57.1					
69	39.0	0.0	17.5	21.5	144	110.8	0.0	52.9	57.9					
70	39.6	0.0	17.7	21.8	145	112.4	0.0	53.7	58.7					
71	40.1	0.0	17.9	22.2	146	114.0	0.0	54.5	59.5					
72	40.7	0.0	18.1	22.6	147	115.5	0.0	55.2	60.3					
73	41.3	0.0	18.3	23.0	148	117.2	0.0	56.0	61.1					
74	41.9	0.0	18.5	23.4	149	118.8	0.0	56.9	61.9					
75	42.5	0.0	18.7	23.7	150	120.5	0.0	57.7	62.7					

## 5.4 Electronic Expansion Valve PI Control

### Main electronic expansion valve EVM control

When the outdoor unit heat exchanging is performed via the condenser (Y7S, Y9S or Y10S is set to OFF), this function is used to exert PI control on the electronic expansion valve (Y1E, Y2E or Y5E) so that the condenser outlet subcooling degree (SC) will become constant.

$$SC = T_c - T_f$$

SC: Condenser outlet subcooling degree

T<sub>c</sub>: High pressure equivalent saturated temperature

T<sub>f</sub>: Liquid pipe temperature detected by heat exchanger liquid pipe thermistor R6T, R7T, R22T

When the outdoor unit heat exchanging is performed via the evaporator (Y7S, Y9S or Y10S is set to ON), this function is used to exert PI control on the electronic expansion valve (Y1E, Y2E or Y5E) so that the evaporator outlet superheating degree (SH) will become constant.

$$SH = T_g - T_e$$

SH: Evaporator outlet superheating degree

T<sub>g</sub>: Suction pipe temperature detected by heat exchanger gas pipe thermistor R2T, R9T, R21T

T<sub>e</sub>: Low pressure equivalent saturated temperature

### Subcooling electronic expansion valve EVT control

In order to make the maximum use of the subcooling heat exchanger, this function is used to exert PI control on the electronic expansion valve (Y3E) so that the evaporator-side gas pipe superheating degree (SH) will become constant.

$$SH = T_{sh} - T_m$$

SH: Evaporator outlet superheating degree

T<sub>sh</sub>: Suction pipe temperature detected by the subcooling heat exchanger outlet thermistor R12T

T<sub>m</sub>: Low or middle pressure equivalent saturated temperature

## 5.5 Step Control of Outdoor Fans

Used to control the revolutions of outdoor fans in the steps listed in table below, according to condition changes.

Step X	Cooling	Heating/ Simultaneous
REYQ72AA	30	30
REYQ96AA	50	49
REYQ120AA	50	49
REYQ144AA	64	61
REYQ168AA	64	62
REYQ192AA	35	35
REYQ216AA	37	37
REYQ240AA	37	37

**REYQ72AA**

Step No.	Standard (default)	
	Cooling	Heating
	M1F	M1F
0	0	0
1	200	200
2	209	209
3	219	219
4	230	230
5	240	240
6	252	252
7	264	264
8	276	276
9	290	290
10	303	303
11	318	318
12	333	333
13	349	349
14	366	366
15	384	384
16	402	402
17	422	422
18	442	442
19	464	464
20	486	486
21	510	510
22	535	535
23	561	561
24	588	588
25	617	617
26	647	647
27	679	679
28	713	713
29	748	748
30	776	807

**REYQ96/120AA**

Step No.	Standard (default)			
	Cooling		Heating	
	M1F	M2F	M1F	M2F
0	0	0	0	0
1	200	0	200	0
2	210	0	210	0
3	220	0	220	0
4	232	0	232	0
5	243	0	243	0
6	255	0	255	0
7	268	0	268	0
8	281	0	281	0
9	295	0	295	0
10	310	0	310	0
11	326	0	326	0
12	342	0	342	0
13	359	0	359	0
14	377	0	377	0
15	396	0	396	0
16	213	203	213	203
17	223	213	223	213
18	234	224	234	224
19	246	236	246	236
20	258	248	258	248
21	270	260	270	260
22	284	274	284	274
23	298	288	298	288
24	312	302	312	302
25	328	318	328	318
26	344	334	344	334
27	361	351	361	351
28	382	365	382	365
29	404	380	404	380
30	427	397	427	397
31	451	414	451	414
32	476	432	476	432
33	502	451	502	451
34	529	471	529	471
35	558	493	558	493
36	588	515	588	515
37	619	539	619	539
38	652	564	652	564
39	686	591	686	591
40	721	620	721	620
41	758	650	758	650
42	797	681	797	681
43	837	715	837	715
44	879	751	879	751
45	923	789	923	789
46	968	829	968	829
47	1,015	872	1,015	872
48	1,064	917	1,064	917
49	1,115	966	1,092	944
50	1,177	1,027	1,092	944

←Heating upper limit  
←Cooling upper limit

**REYQ144/168AA**

Step No.	Standard (default)			
	Cooling		Heating	
	M1F	M2F	M1F	M2F
0	0	0	0	0
1	200	0	200	0
2	205	0	205	0
3	211	0	211	0
4	217	0	217	0
5	223	0	223	0
6	230	0	230	0
7	236	0	236	0
8	244	0	244	0
9	251	0	251	0
10	259	0	259	0
11	267	0	267	0
12	276	0	276	0
13	285	0	285	0
14	295	0	295	0
15	305	0	305	0
16	316	0	316	0
17	327	0	327	0
18	338	0	338	0
19	351	0	351	0
20	363	0	363	0
21	377	0	377	0
22	391	0	391	0
23	406	0	406	0
24	216	206	216	206
25	224	214	224	214
26	233	223	233	223
27	242	232	242	232
28	251	241	251	241
29	261	251	261	251
30	272	262	272	262
31	283	273	283	273
32	294	284	294	284
33	307	297	307	297
34	319	309	319	309
35	333	323	333	323
36	347	337	347	337
37	362	351	362	351
38	380	364	380	364
39	399	377	399	377
40	419	391	419	391
41	440	406	440	406
42	462	422	462	422
43	485	439	485	439
44	509	456	509	456
45	534	475	534	475
46	561	494	561	494
47	588	515	588	515
48	617	537	617	537
49	646	560	646	560
50	678	585	678	585
51	710	610	710	610
52	744	638	744	638
53	780	667	780	667
54	816	698	816	698
55	855	730	855	730
56	895	765	895	765
57	937	801	937	801
58	980	840	980	840
59	1,025	882	1,025	882
60	1,072	925	1,072	925
61	1,121	972	1,147	997
62	1,171	1,021	1,201	1,051
63	1,224	1,074	1,201	1,051
64	1,302	1,154	1,201	1,051

**REYQ192AA**

Step No.	Standard (default)			
	Cooling		Heating	
	M1F	M2F	M1F	M2F
0	0	0	0	0
1	200	200	200	200
2	213	203	213	203
3	222	212	222	212
4	232	222	232	222
5	241	231	241	231
6	252	242	252	242
7	262	252	262	252
8	274	264	274	264
9	286	276	286	276
10	298	288	298	288
11	311	301	311	301
12	325	315	325	315
13	345	324	345	324
14	365	334	365	334
15	386	345	386	345
16	408	356	408	356
17	431	368	431	368
18	455	382	455	382
19	479	396	479	396
20	505	411	505	411
21	531	428	531	428
22	558	445	558	445
23	586	465	586	465
24	614	485	614	485
25	644	508	644	508
26	674	532	674	532
27	705	559	705	559
28	736	587	736	587
29	769	618	769	618
30	801	651	801	651
31	835	688	835	688
32	868	727	868	727
33	902	770	902	770
34	936	816	936	816
35	971	911	954	894

**REYQ216/240AA**

Step No.	Standard (default)			
	Cooling		Heating	
	M1F	M2F	M1F	M2F
0	0	0	0	0
1	200	200	200	200
2	213	203	213	203
3	222	212	222	212
4	232	222	232	222
5	241	231	241	231
6	252	242	252	242
7	262	252	262	252
8	274	264	274	264
9	286	276	286	276
10	298	288	298	288
11	311	301	311	301
12	325	315	325	315
13	345	324	345	324
14	365	334	365	334
15	386	345	386	345
16	408	356	408	356
17	431	368	431	368
18	455	382	455	382
19	479	396	479	396
20	505	411	505	411
21	531	428	531	428
22	558	445	558	445
23	586	465	586	465
24	614	485	614	485
25	644	508	644	508
26	674	532	674	532
27	705	559	705	559
28	736	587	736	587
29	769	618	769	618
30	801	651	801	651
31	835	688	835	688
32	868	727	868	727
33	902	770	902	770
34	936	816	936	816
35	970	867	970	867
36	1,004	922	1,004	922
37	1,027	967	1,027	967

←REYQ144AA Heating upper limit  
 ←REYQ168AA Heating upper limit  
 ←REYQ144/168AA Cooling upper limit



## 5.6 Heat Exchanger Control

While in heating or cool/heat simultaneous operation, ensure target condensing and evaporating temperature by changing over the air heat exchange of outdoor unit to the evaporator or the condenser in response to loads.

### Single system

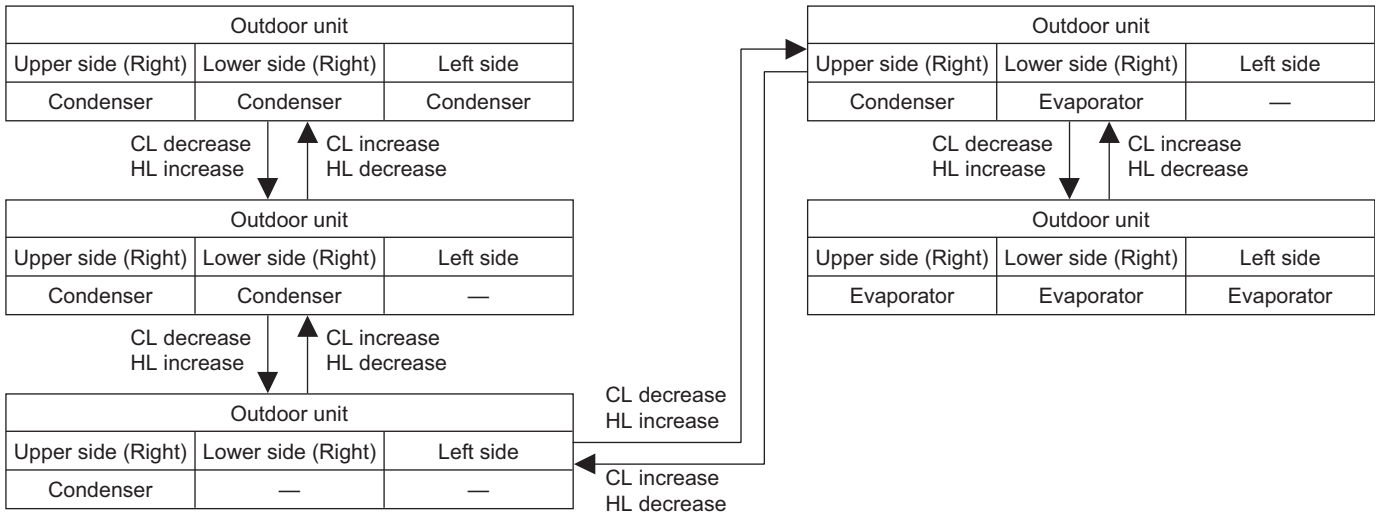

### Multi outdoor unit system

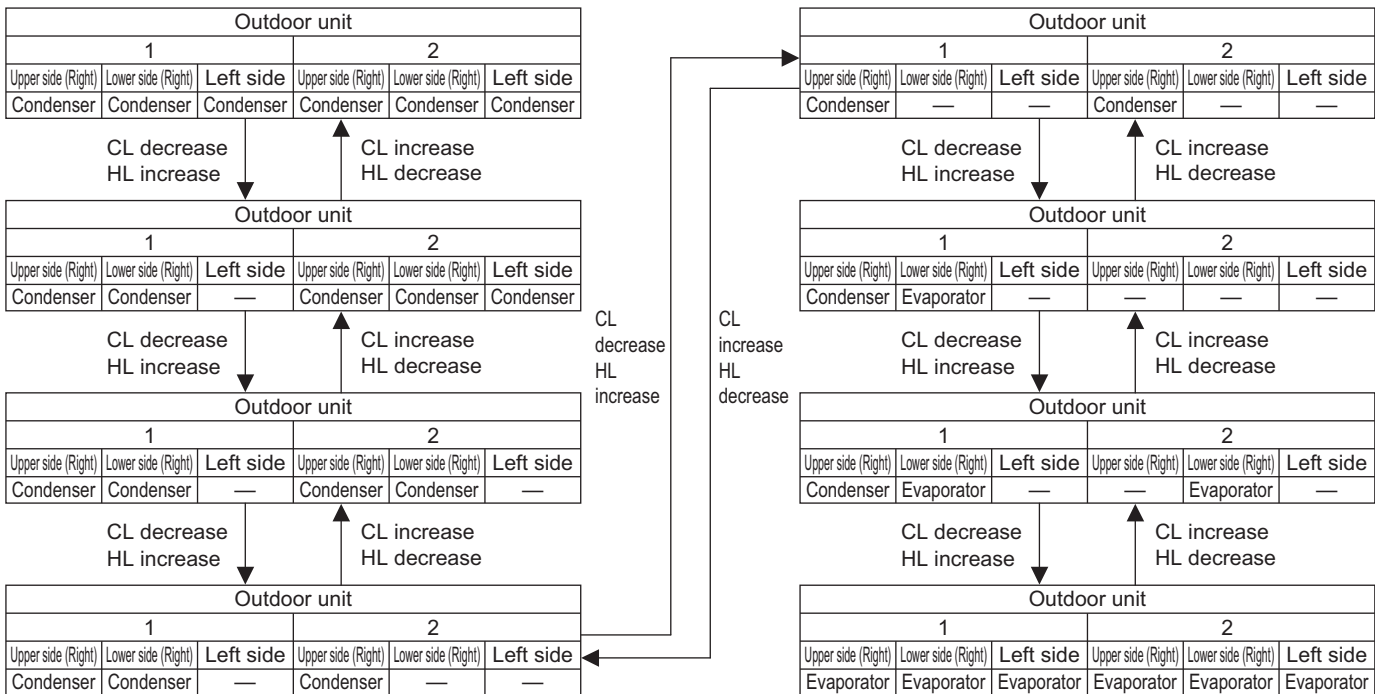

<Symbol meanings>  
 CL: Cooling Load  
 HL: Heating Load

# 6. Protection Control

## 6.1 High Pressure Protection Control

This high pressure protection control is used to prevent the activation of protection devices due to abnormal increase of high pressure and to protect compressors against the transient increase of high pressure.

### Cooling

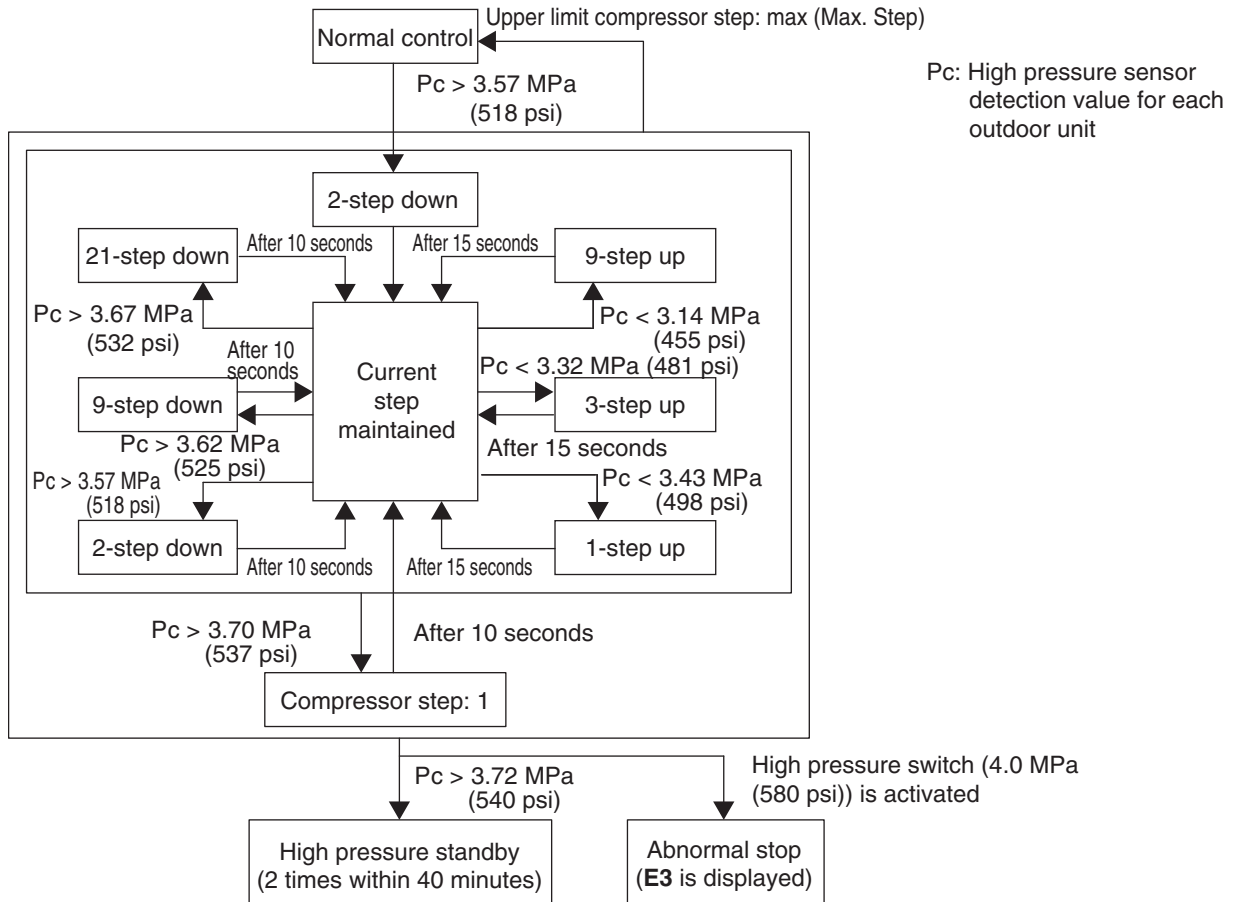

Heating

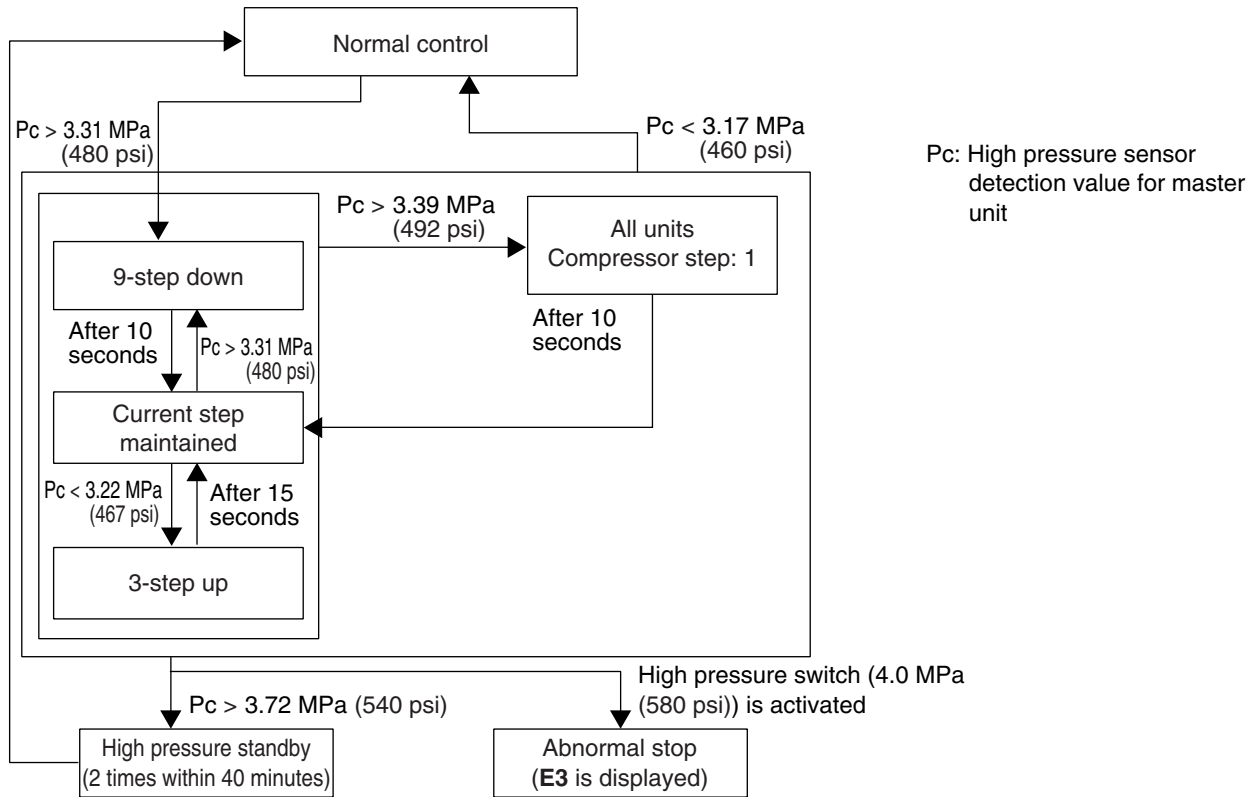

## 6.2 Low Pressure Protection Control

This low pressure protection control is used to protect compressors against the transient decrease of low pressure.

### Cooling

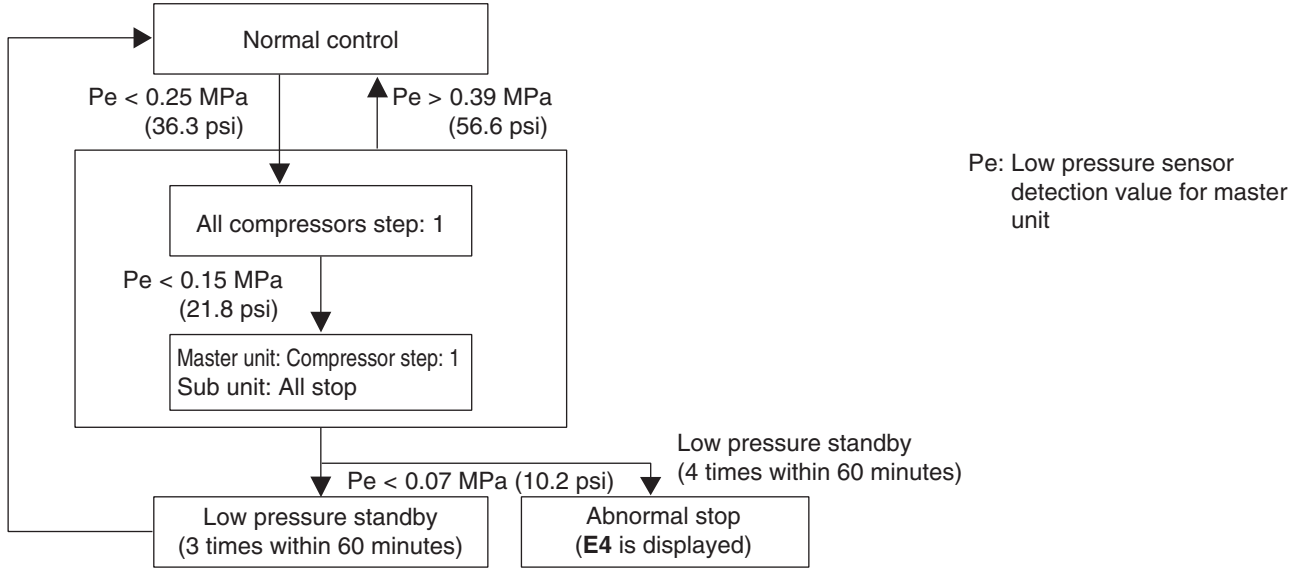

### Heating

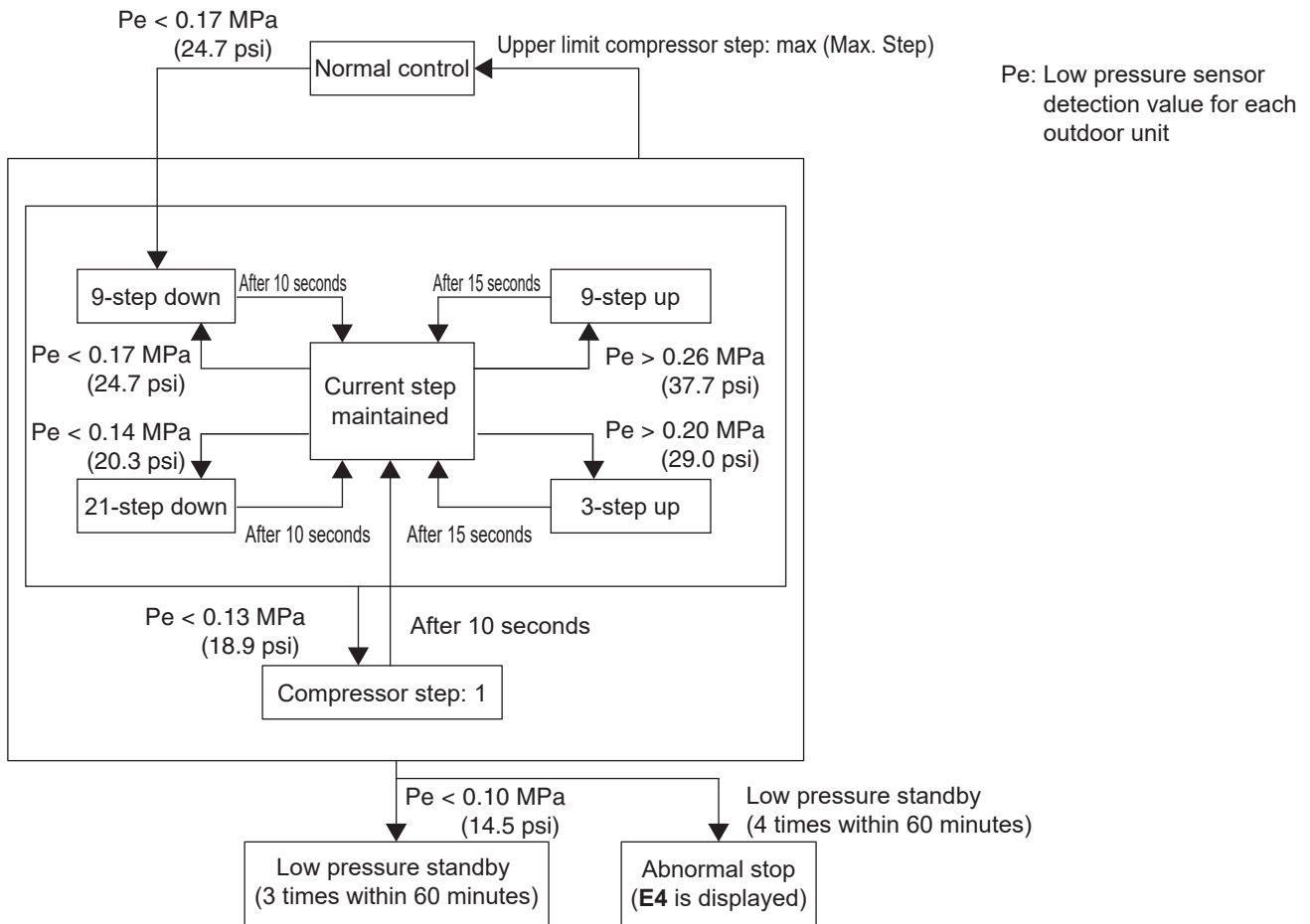

### 6.3 Discharge Pipe Protection Control

This discharge pipe protection control is used to protect the compressor internal temperature against an error or transient increase of discharge pipe temperature.

- HTdi : Value of compressor discharge pipe temperature (Tdi) compensated with outdoor air temperature
- Ti : Compressor body temperature
- A : Maximum of HTdi and Ti
- X (°C)(Y (°F)) : 110°C (230°F) (constant)

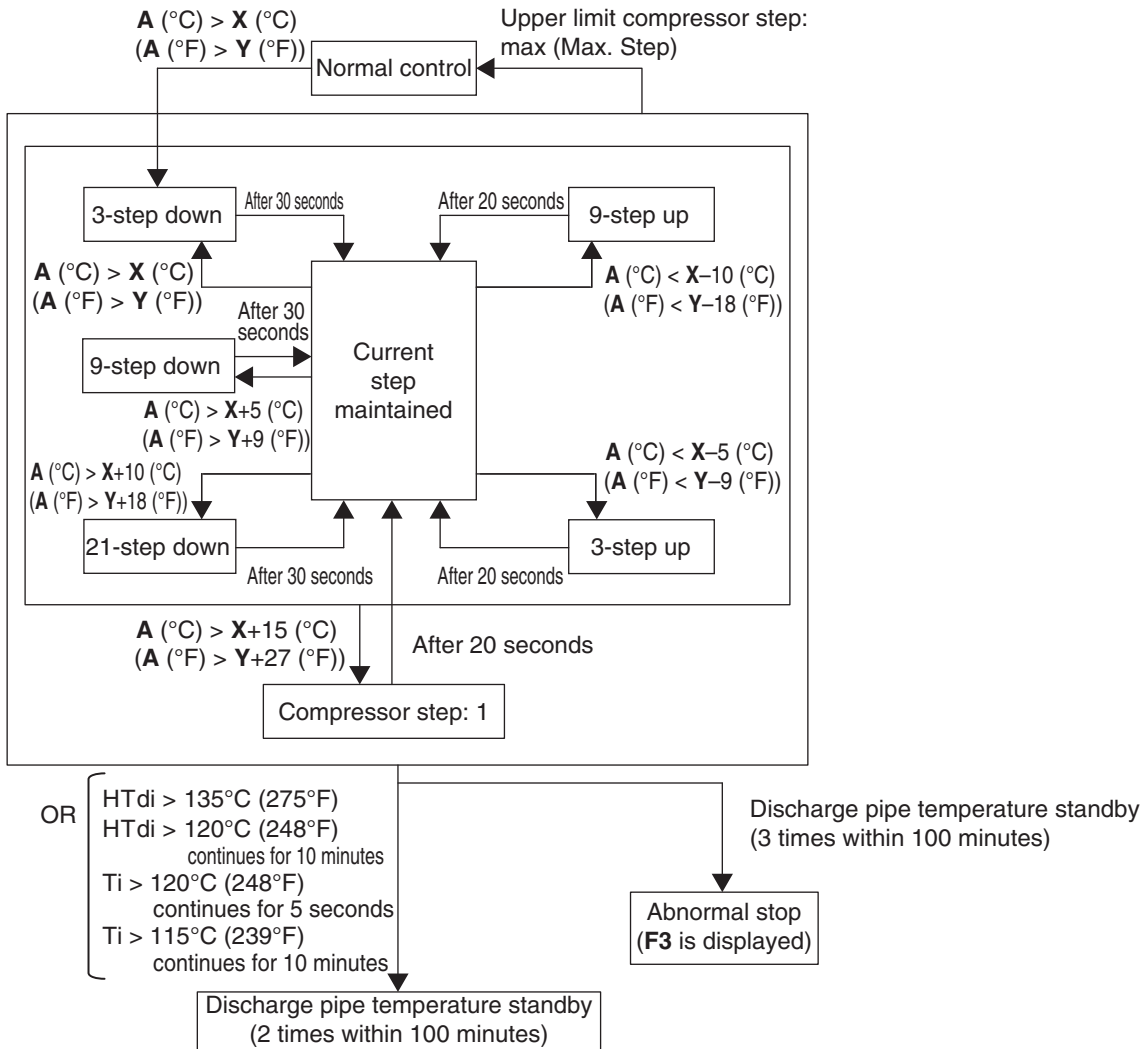

## 6.4 Inverter Protection Control

Inverter current protection control and radiation fin temperature control are performed to prevent tripping due to an abnormality, or transient inverter overcurrent, and fin temperature increase. In the case of multi-outdoor-unit system, each compressor performs these controls in the following sequence.

### Inverter Overcurrent Protection Control

This control is performed for each compressor.

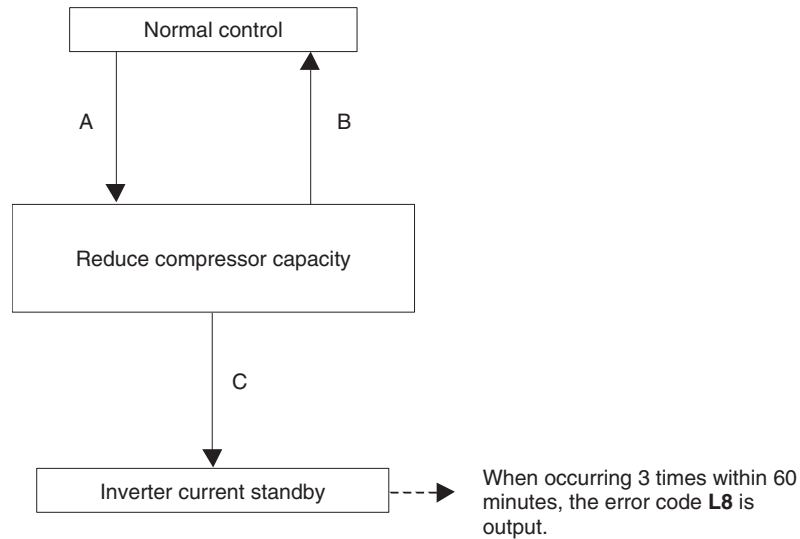

Condition	REYQ72AATJA REYQ72AATJB	REYQ96/120AATJA REYQ96/120AATJB		REYQ144/168AATJA REYQ144/168AATJB		REYQ192/216/240AATJA REYQ192/216/240AATJB	
		M1C	M2C	M1C	M2C	M1C	M2C
A	more than 49.0 A	more than 30.5 A	more than 30.5 A	more than 30.5 A	more than 49.0 A	more than 49.0 A	more than 49.0 A
B	less than 48.3 A	less than 29.4 A	less than 29.4 A	less than 29.4 A	less than 48.3 A	less than 48.3 A	less than 48.3 A
C	more than 51.0 A	more than 32.5 A	more than 32.5 A	more than 32.5 A	more than 51.0 A	more than 51.0 A	more than 51.0 A

Condition	REYQ72AAYDA REYQ72AAYDB	REYQ96/120AAYDA REYQ96/120AAYDB		REYQ144/168AAYDA REYQ144/168AAYDB		REYQ192/216/240AAYDA REYQ192/216/240AAYDB	
		M1C	M2C	M1C	M2C	M1C	M2C
A	more than 28.0 A	more than 19.0 A	more than 19.0 A	more than 19.0 A	more than 28.0 A	more than 28.0 A	more than 28.0 A
B	less than 27.2 A	less than 18.2 A	less than 18.2 A	less than 18.2 A	less than 27.2 A	less than 27.2 A	less than 27.2 A
C	more than 30.0 A	more than 21.0 A	more than 21.0 A	more than 21.0 A	more than 30.0 A	more than 30.0 A	more than 30.0 A

**Radiation Fin Temperature Control**

Perform the following control of integrated as well as multi units for each compressor.

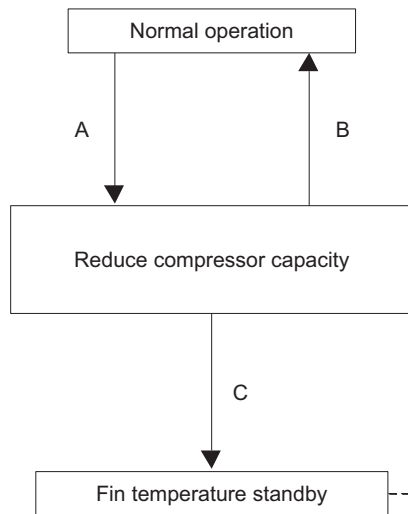

When occurring 4 times within 60 minutes, the error code **L4** is output.

Condition	REYQ72AATJA REYQ72AATJB	REYQ96/120AATJA REYQ96/120AATJB		REYQ144/168AATJA REYQ144/168AATJB		REYQ192/216/240AATJA REYQ192/216/240AATJB	
		M1C	M2C	M1C	M2C	M1C	M2C
A	more than 103°C (217°F)	more than 100°C (212°F)	more than 100°C (212°F)	more than 100°C (212°F)	more than 103°C (217°F)	more than 103°C (217°F)	more than 103°C (217°F)
B	less than 100°C (212°F)	less than 97°C (207°F)	less than 97°C (207°F)	less than 97°C (207°F)	less than 100°C (212°F)	less than 100°C (212°F)	less than 100°C (212°F)
C	more than 108°C (226°F)	more than 103°C (217°F)	more than 103°C (217°F)	more than 103°C (217°F)	more than 108°C (226°F)	more than 108°C (226°F)	more than 108°C (226°F)

Condition	REYQ72AAYDA REYQ72AAYDB	REYQ96/120AAYDA REYQ96/120AAYDB		REYQ144/168AAYDA REYQ144/168AAYDB		REYQ192/216/240AAYDA REYQ192/216/240AAYDB	
		M1C	M2C	M1C	M2C	M1C	M2C
A	more than 109°C (228°F)	more than 109°C (228°F)	more than 109°C (228°F)	more than 109°C (228°F)	more than 109°C (228°F)	more than 109°C (228°F)	more than 109°C (228°F)
B	less than 106°C (223°F)	less than 106°C (223°F)	less than 106°C (223°F)	less than 106°C (223°F)	less than 106°C (223°F)	less than 106°C (223°F)	less than 106°C (223°F)
C	more than 114°C (237°F)	more than 114°C (237°F)	more than 114°C (237°F)	more than 114°C (237°F)	more than 114°C (237°F)	more than 114°C (237°F)	more than 114°C (237°F)

## 7. Special Control

### 7.1 Pump Down Residual Operation

If the liquid refrigerant stays in the evaporator at the startup of a compressor, this liquid refrigerant enters the compressor, thus resulting in diluted oil in the compressor and then degraded lubrication performance.

Consequently, in order to recover the refrigerant in the evaporator while the compressor stops, the pump down residual operation is conducted.

Pc: High pressure sensor detection value

Pe: Low pressure sensor detection value

Ta: Outdoor air temperature

Te: Low pressure equivalent saturation temperature

DSH: Discharge pipe superheating degree

Part name	Electric symbol	Function of functional part	
		Cooling	Heating
Compressor motor	M1C, M2C	REYQ72/192/216/240AA: 25 rps REYQ96/120/144/168AA: 37 rps	REYQ72/192/216/240AA: 80 rps REYQ96/120/144/168AA: 75 rps
Fan motor	M1F, M2F	For heat exchanger mode	For heat exchanger mode
Electronic expansion valve (Heat exchanger right upper)	Y1E	Same as normal control	Same as normal control
Electronic expansion valve (Heat exchanger right lower)	Y2E		
Electronic expansion valve (Heat exchanger left)	Y5E		
Electronic expansion valve (Subcooling heat exchanger)	Y3E	0 pulse	0 pulse
Electronic expansion valve (Receiver gas purge)	Y4E	Open slightly	Open slightly
Electronic expansion valve (Refrigerant cooling IPM)	Y6E	Same as normal control	Same as normal control
Electronic expansion valve (Refrigerant cooling air)	Y7E		
Solenoid valve (Oil separator oil return)	Y1S, Y2S	ON	ON
Solenoid valve (Liquid shutoff)	Y3S	ON	ON
Solenoid valve (Accumulator oil return)	Y4S	OFF	OFF
Solenoid valve (Refrigerant adjustment)	Y5S	OFF	OFF
Solenoid valve (Injection)	Y6S	ON	ON
Four way valve (Heat exchanger right upper)	Y10S	Hold	Hold
Four way valve (Heat exchanger right lower)	Y7S		
Four way valve (Heat exchanger left)	Y9S		
Four way valve (HP/LP gas pipe)	Y8S		
Solenoid valve (Refrigerant cooling bypass)	Y11S	Same as normal control	Same as normal control
Ending condition		OR $\left\{ \begin{array}{l} \text{A lapse of 2 minutes} \\ \text{Master unit HTdi} > 118^{\circ}\text{C} (244.4^{\circ}\text{F}) \\ \text{Pc}_{\text{max}} > 2.94 \text{ MPa} (426 \text{ psi}) \end{array} \right.$	OR $\left\{ \begin{array}{l} \text{A lapse of 3 minutes} \\ \text{Pe}_{\text{min}} < 0.19 \text{ MPa} (27.6 \text{ psi}) \\ \& \text{Ta}_{\text{min}} - \text{Te}_{\text{max}} > 8^{\circ}\text{C} (14^{\circ}\text{F}) \\ \text{HTdi}_{\text{max}} > 118^{\circ}\text{C} (244.4^{\circ}\text{F}) \end{array} \right.$



## 7.2 Oil Return Operation

In order to prevent the compressor from running out of oil, the oil return operation is conducted to recover oil that has flowed out from the compressor to the system side.

Tc: High pressure equivalent saturation temperature

Te: Low pressure equivalent saturation temperature

TsA: Suction pipe temperature detected by thermistor R5T

### 7.2.1 Oil Return Operation in Cooling Operation

#### Starting Conditions

- Oil return operation is not conducted before 2 hours have elapsed from the activation of power supply.
- After 2 hours have elapsed, oil return operation starts when the following item meets the reference value.
  - Total amount of oil discharged from the compressor  
(The total amount of oil discharged from the compressor is computed from Tc, Te, and compressor loads.)
- Oil return control starts every 8 hours of cumulative operation of the compressor, even if the reference value is not met.

Part name	Electric symbol	Function of functional part
Compressor motor	M1C, M2C	Constant low pressure control
Fan motor	M1F, M2F	For heat exchanger mode
Electronic expansion valve (Heat exchanger right upper)	Y1E	Same as normal control
Electronic expansion valve (Heat exchanger right lower)	Y2E	
Electronic expansion valve (Heat exchanger left)	Y5E	
Electronic expansion valve (Subcooling heat exchanger)	Y3E	0 pulse
Electronic expansion valve (Receiver gas purge)	Y4E	0 pulse
Electronic expansion valve (Refrigerant cooling IPM)	Y6E	Same as normal control
Electronic expansion valve (Refrigerant cooling air)	Y7E	
Solenoid valve (Oil separator oil return)	Y1S, Y2S	ON
Solenoid valve (Liquid shutoff)	Y3S	ON
Solenoid valve (Accumulator oil return)	Y4S	ON
Solenoid valve (Refrigerant adjustment)	Y5S	OFF
Solenoid valve (Injection)	Y6S	ON
Four way valve (Heat exchanger right upper)	Y10S	Hold
Four way valve (Heat exchanger right lower)	Y7S	
Four way valve (Heat exchanger left)	Y9S	
Four way valve (HP/LP gas pipe)	Y8S	
Solenoid valve (Refrigerant cooling bypass)	Y11S	Same as normal control
Ending condition		& OR [ <ul style="list-style-type: none"> <li>• A lapse of 3 minutes</li> <li>• <math>TsA - Te &lt; 3^{\circ}C</math> (<math>5.4^{\circ}F</math>)</li> <li>• A lapse of 6 minutes while the frequency is more than that of oil return operation.</li> </ul>

Indoor unit actuator	Oil return operation	
Fan	Thermostat ON unit	Remote controller setting
	Non-operating unit	OFF
	Thermostat OFF unit	Remote controller setting
Electronic expansion valve	Thermostat ON unit	Normal control
	Non-operating unit	224 pulse
	Thermostat OFF unit	Forced thermostat ON (PI control)

Branch Selector unit actuator		Normal cooling	
Electronic expansion valve (EVSC)	Y1E	Thermostat ON	0 pulse
		Non-operating	0 pulse
		Thermostat OFF	0 pulse
Electronic expansion valve (EVH)	Y2E	Thermostat ON	6,000 pulse
		Non-operating	6,000 pulse
		Thermostat OFF	6,000 pulse
Electronic expansion valve (EVL)	Y3E	Thermostat ON	6,000 pulse
		Non-operating	6,000 pulse
		Thermostat OFF	6,000 pulse

## 7.2.2 Oil Return Operation in Heating Operation

Part name	Electric symbol	Function of functional part
Compressor motor	M1C, M2C	Constant high pressure control
Fan motor	M1F, M2F	For heat exchanger mode
Electronic expansion valve (Heat exchanger right upper)	Y1E	Same as normal control
Electronic expansion valve (Heat exchanger right lower)	Y2E	
Electronic expansion valve (Heat exchanger left)	Y5E	
Electronic expansion valve (Subcooling heat exchanger)	Y3E	Same as normal control
Electronic expansion valve (Receiver gas purge)	Y4E	Same as normal control
Electronic expansion valve (Refrigerant cooling IPM)	Y6E	Same as normal control
Electronic expansion valve (Refrigerant cooling air)	Y7E	
Solenoid valve (Oil separator oil return)	Y1S, Y2S	ON
Solenoid valve (Liquid shutoff)	Y3S	Same as normal control
Solenoid valve (Accumulator oil return)	Y4S	ON
Solenoid valve (Refrigerant adjustment)	Y5S	OFF
Solenoid valve (Injection)	Y6S	Same as normal control
Four way valve (Heat exchanger right upper)	Y10S	Hold
Four way valve (Heat exchanger right lower)	Y7S	
Four way valve (Heat exchanger left)	Y9S	
Four way valve (HP/LP gas pipe)	Y8S	
Solenoid valve (Refrigerant cooling bypass)	Y11S	Same as normal control
Ending condition		A lapse of 6 minutes while the frequency is more than that of oil return operation.

Indoor unit actuator		Cooling	Heating
Fan	Thermostat ON unit	Remote controller setting	Remote controller setting
	Non-operating unit	OFF	OFF
	Thermostat OFF unit	Remote controller setting	Remote controller setting
Electronic expansion valve	Thermostat ON unit	Normal control	Normal control
	Non-operating unit	224 pulse	224 pulse
	Thermostat OFF unit	Forced thermostat ON	224 pulse

Branch Selector unit actuator			Normal simultaneous cooling/heating		Normal heating
			Cooling	Heating	
Electronic expansion valve (EVSC)	Y1E	Thermostat ON	0 pulse	Subcooling degree control	0 pulse
		Non-operating	0 pulse	0 pulse	0 pulse
		Thermostat OFF	0 pulse	0 pulse	0 pulse
Electronic expansion valve (EVH)	Y2E	Thermostat ON	0 pulse	6,000 pulse	6,000 pulse
		Non-operating	0 pulse	6,000 pulse	6,000 pulse
		Thermostat OFF	0 pulse	6,000 pulse	6,000 pulse
Electronic expansion valve (EVL)	Y3E	Thermostat ON	6,000 pulse	0 pulse	0 pulse
		Non-operating	6,000 pulse	0 pulse	0 pulse
		Thermostat OFF	6,000 pulse	0 pulse	0 pulse

## 7.3 Defrost Operation

To defrost the outdoor heat exchanger while in Evaporator, the defrost operation is conducted to recover the heating capacity.

Tb: Heat exchanger deicer temperature

**REYQ72-168AA single system and REYQ192-240AA single system when outside temperature is lower than 0°C (32°F)**

Part name	Electric symbol	Function of functional part
Compressor motor	M1C, M2C	REYQ72AA: 127.3 rps REYQ96/120AA: 125.4 rps + 140.0 rps REYQ144/168AA: 85.2 rps + 114.9 rps REYQ192/216/240AA: 135.0 rps + 140.0 rps
Fan motor	M1F, M2F	With high pressure OFF ↔ Step X/2 ↔ Step X
Electronic expansion valve (Heat exchanger right upper)	Y1E	100%
Electronic expansion valve (Heat exchanger right lower)	Y2E	
Electronic expansion valve (Heat exchanger left)	Y5E	
Electronic expansion valve (Subcooling heat exchanger)	Y3E	Discharge temperature control
Electronic expansion valve (Receiver gas purge)	Y4E	Liquid recovery control
Electronic expansion valve (Refrigerant cooling IPM)	Y6E	Same as normal control
Electronic expansion valve (Refrigerant cooling air)	Y7E	
Solenoid valve (Oil separator oil return)	Y1S, Y2S	ON
Solenoid valve (Liquid shutoff)	Y3S	ON
Solenoid valve (Accumulator oil return)	Y4S	ON
Solenoid valve (Refrigerant adjustment)	Y5S	OFF
Solenoid valve (Injection)	Y6S	ON
Four way valve (Heat exchanger right upper)	Y10S	OFF
Four way valve (Heat exchanger right lower)	Y7S	OFF
Four way valve (Heat exchanger left)	Y9S	OFF
Four way valve (HP/LP gas pipe)	Y8S	ON
Solenoid valve (Refrigerant cooling bypass)	Y11S	Same as normal control
Ending condition		OR <ul style="list-style-type: none"> <li>• A lapse of 15 minutes</li> <li>• Tb &gt; 11°C (51.8°F) continues for 60 seconds or more</li> </ul>

Indoor unit actuator		Defrost operation
Fan	Thermostat ON unit	OFF
	Non-operating unit	OFF
	Thermostat OFF unit	OFF
Electronic expansion valve	Thermostat ON unit	Defrost EV opening degree
	Non-operating unit	Defrost EV opening degree
	Thermostat OFF unit	Defrost EV opening degree

Branch Selector unit actuator			Normal cooling	Normal simultaneous cooling/heating		Normal heating
				Cooling	Heating	
Electronic expansion valve (EVSC)	Y1E	Thermostat ON	0 pulse	0 pulse	Subcooling degree control	0 pulse
		Non-operating	0 pulse	0 pulse	0 pulse	0 pulse
		Thermostat OFF	0 pulse	0 pulse	0 pulse	0 pulse
Electronic expansion valve (EVH)	Y2E	Thermostat ON	6,000 pulse	0 pulse	6,000 pulse	6,000 pulse
		Non-operating	6,000 pulse	0 pulse	6,000 pulse	6,000 pulse
		Thermostat OFF	6,000 pulse	0 pulse	6,000 pulse	6,000 pulse
Electronic expansion valve (EVL)	Y3E	Thermostat ON	6,000 pulse	6,000 pulse	0 pulse	0 pulse
		Non-operating	6,000 pulse	6,000 pulse	0 pulse	0 pulse
		Thermostat OFF	6,000 pulse	6,000 pulse	0 pulse	0 pulse

**REYQ192-240AA single system when outside temperature is higher than 0°C (32°F)**

Part name	Electric symbol	Function of functional part
Compressor motor	M1C, M2C	135.0 rps + 140.0 rps
Fan motor	M1F, M2F	(Defrosting side) With high pressure OFF ↔ Step X/2 ↔ Step X  (Evaporating side) MAX Step
Electronic expansion valve (Heat exchanger right upper)	Y1E	(Defrosting side) 100%
Electronic expansion valve (Heat exchanger right lower)	Y2E	
Electronic expansion valve (Heat exchanger left)	Y5E	(Evaporating side) Superheat control
Electronic expansion valve (Subcooling heat exchanger)	Y3E	Discharge temperature control
Electronic expansion valve (Receiver gas purge)	Y4E	Liquid recovery control
Electronic expansion valve (Refrigerant cooling IPM)	Y6E	Same as normal control
Electronic expansion valve (Refrigerant cooling air)	Y7E	
Solenoid valve (Oil separator oil return)	Y1S, Y2S	ON
Solenoid valve (Liquid shutoff)	Y3S	ON
Solenoid valve (Accumulator oil return)	Y4S	ON
Solenoid valve (Refrigerant adjustment)	Y5S	OFF
Solenoid valve (Injection)	Y6S	ON
Four way valve (Heat exchanger right upper)	Y10S	(Defrosting side) OFF
Four way valve (Heat exchanger right lower)	Y7S	
Four way valve (Heat exchanger left)	Y9S	(Evaporating side) ON
Four way valve (HP/LP gas pipe)	Y8S	OFF
Solenoid valve (Refrigerant cooling bypass)	Y11S	Same as normal control
Ending condition		OR <ul style="list-style-type: none"> <li>• A lapse of 8 minutes</li> <li>• Tb &gt; 11°C (51.8°F) continues for 60 seconds or more</li> </ul>

Indoor unit actuator		Cooling	Heating
Fan	Thermostat ON unit	Remote controller setting	OFF
	Non-operating unit	OFF	OFF
	Thermostat OFF unit	Remote controller setting	OFF
Electronic expansion valve	Thermostat ON unit	Normal control	0 pulse
	Non-operating unit	0 pulse	0 pulse
	Thermostat OFF unit	0 pulse	0 pulse

Branch Selector unit actuator		Normal cooling	Normal simultaneous cooling/heating		Normal heating
			Cooling	Heating	
Electronic expansion valve (EVSC)	Y1E	Thermostat ON	0 pulse	0 pulse	Subcooling degree control 0 pulse
		Non-operating	0 pulse	0 pulse	0 pulse
		Thermostat OFF	0 pulse	0 pulse	0 pulse
Electronic expansion valve (EVH)	Y2E	Thermostat ON	6,000 pulse	0 pulse	6,000 pulse
		Non-operating	6,000 pulse	0 pulse	6,000 pulse
		Thermostat OFF	6,000 pulse	0 pulse	6,000 pulse
Electronic expansion valve (EVL)	Y3E	Thermostat ON	6,000 pulse	6,000 pulse	0 pulse
		Non-operating	6,000 pulse	6,000 pulse	0 pulse
		Thermostat OFF	6,000 pulse	6,000 pulse	0 pulse

## Multi system

Part name	Electric symbol	Function of functional part	
		Defrosting unit	Evaporator unit
Compressor motor	M1C, M2C	REYQ72AA: 127.3 rps REYQ96/120AA: 125.4 rps + 140.0 rps REYQ144/168AA: 85.2 rps + 114.9 rps REYQ192/216/240AA: 135.0 rps + 140.0 rps	
Fan motor	M1F, M2F	With high pressure OFF ↔ Step X/2 ↔ Step X	MAX Step
Electronic expansion valve (Heat exchanger right upper)	Y1E	100%	Superheat control
Electronic expansion valve (Heat exchanger right lower)	Y2E		
Electronic expansion valve (Heat exchanger left)	Y5E		
Electronic expansion valve (Subcooling heat exchanger)	Y3E	Discharge temperature control	
Electronic expansion valve (Receiver gas purge)	Y4E	0 pulse	
Electronic expansion valve (Refrigerant cooling IPM)	Y6E	Same as normal control	
Electronic expansion valve (Refrigerant cooling air)	Y7E		
Solenoid valve (Oil separator oil return)	Y1S, Y2S	ON	
Solenoid valve (Liquid shutoff)	Y3S	ON	
Solenoid valve (Accumulator oil return)	Y4S	ON	
Solenoid valve (Refrigerant adjustment)	Y5S	OFF	
Solenoid valve (Injection)	Y6S	ON	
Four way valve (Heat exchanger right upper)	Y10S	OFF	ON
Four way valve (Heat exchanger right lower)	Y7S	OFF	ON
Four way valve (Heat exchanger left)	Y9S	OFF	ON
Four way valve (HP/LP gas pipe)	Y8S	OFF	
Solenoid valve (Refrigerant cooling bypass)	Y11S	Same as normal control	
Ending condition		OR <ul style="list-style-type: none"> <li>• A lapse of 8 minutes</li> <li>• Tb &gt; 11°C (51.8°F) continues for 60 seconds or more</li> </ul>	

Indoor unit actuator		Cooling	Heating
Fan	Thermostat ON unit	Remote controller setting	OFF
	Non-operating unit	OFF	OFF
	Thermostat OFF unit	Remote controller setting	OFF
Electronic expansion valve	Thermostat ON unit	Normal control	0 pulse
	Non-operating unit	0 pulse	0 pulse
	Thermostat OFF unit	0 pulse	0 pulse

Branch Selector unit actuator			Normal cooling	Normal simultaneous cooling/heating		Normal heating
				Cooling	Heating	
Electronic expansion valve (EVSC)	Y1E	Thermostat ON	0 pulse	0 pulse	Subcooling degree control	0 pulse
		Non-operating	0 pulse	0 pulse	0 pulse	0 pulse
		Thermostat OFF	0 pulse	0 pulse	0 pulse	0 pulse
Electronic expansion valve (EVH)	Y2E	Thermostat ON	6,000 pulse	0 pulse	6,000 pulse	6,000 pulse
		Non-operating	6,000 pulse	0 pulse	6,000 pulse	6,000 pulse
		Thermostat OFF	6,000 pulse	0 pulse	6,000 pulse	6,000 pulse
Electronic expansion valve (EVL)	Y3E	Thermostat ON	6,000 pulse	6,000 pulse	0 pulse	0 pulse
		Non-operating	6,000 pulse	6,000 pulse	0 pulse	0 pulse
		Thermostat OFF	6,000 pulse	6,000 pulse	0 pulse	0 pulse

## 7.4 Outdoor Unit Rotation

In the case of multi outdoor unit system, this outdoor unit rotation prevents the compressor from breaking down due to unbalanced oil level between outdoor units.

### Details of outdoor unit rotation

In the case of multi outdoor unit system, each outdoor unit is given an operating priority for the control.

The operating priority of outdoor units is changed by outdoor unit rotation. The outdoor unit rotation prevents unbalanced oil level between outdoor units by eliminating the long stop of compressors during partial load.

### Timing of outdoor unit rotation

- At the beginning of the startup control, or;
- After oil return operation, or;
- After defrost operation, or;
- One of the outdoor units is stopped for 20 minutes or more (only in cooling).

Example) The following diagram shows outdoor unit rotation.

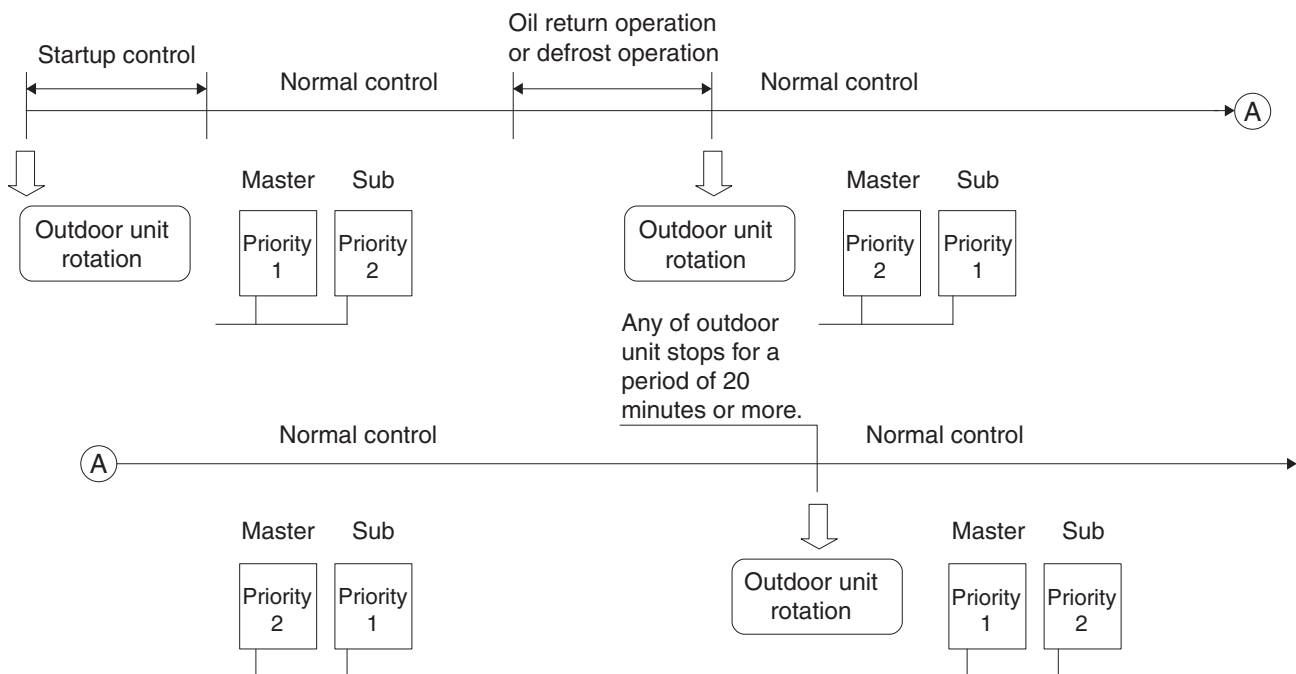

### Note(s)

\* Master unit and sub unit in this section are the names for installation.

They are determined in installation work, and not changed thereafter. (These names are different from master unit and sub unit for control.)

The outdoor unit connected the control wires (F1 and F2) for the indoor unit should be designated as master unit.

Consequently, the LED display on the outdoor unit main PCB for master unit, sub unit does not change.

## 7.5 Cooling/Heating Mode Switching

### While in cooling/heating mixed mode, single-room cooling → heating

First, the electronic expansion valve of the indoor unit in cooling operation will close, and the Y2E and Y3E electronic expansion valves of the branch selector unit will all close once. Next, the Y2E electronic expansion valve will open little by little to perform pressure equalization. Then the electronic expansion valve will fully open, and the electronic expansion valve of the indoor unit will open to activate the heating circuit. The required switching time is approximately 6 minutes. (Field settings, however, can shorten the time from 6 minutes to 4 minutes.)

(1) In cooling operation

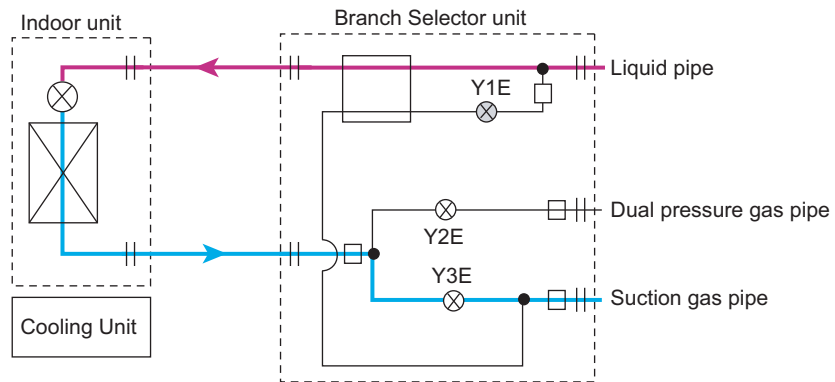

(2) In equalization

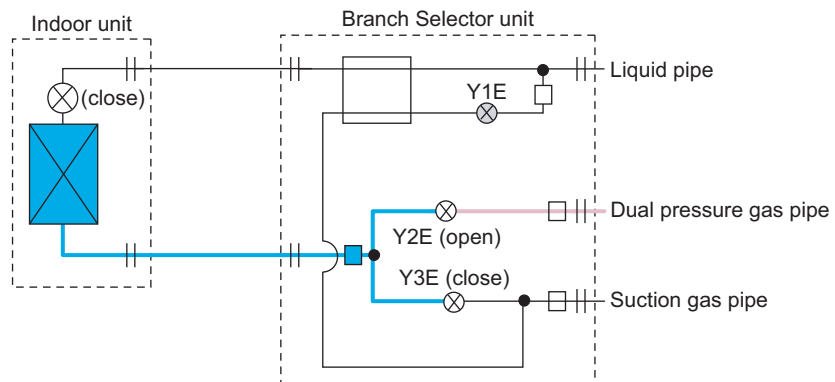

(3) To heating mode

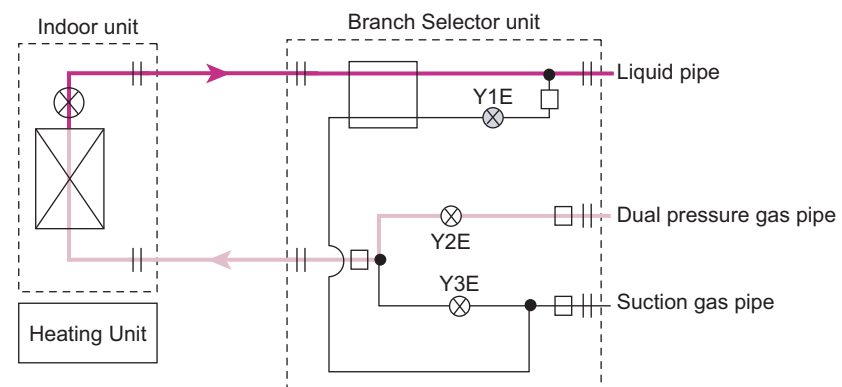



**While in cooling/heating mixed mode, single-room heating → cooling**

First, the electronic expansion valve of the indoor unit in heating operation will close, and the Y2E and Y3E electronic expansion valves of the branch selector unit will all close once. Next, the Y3E electronic expansion valve will open little by little to perform pressure equalization. Then the electronic expansion valve will fully open, and the electronic expansion valve of the indoor unit will open to activate the heating circuit. The required switching time is approximately 6 minutes. (Field settings, however, can shorten the time from 6 minutes to 4 minutes.)

(1) In heating

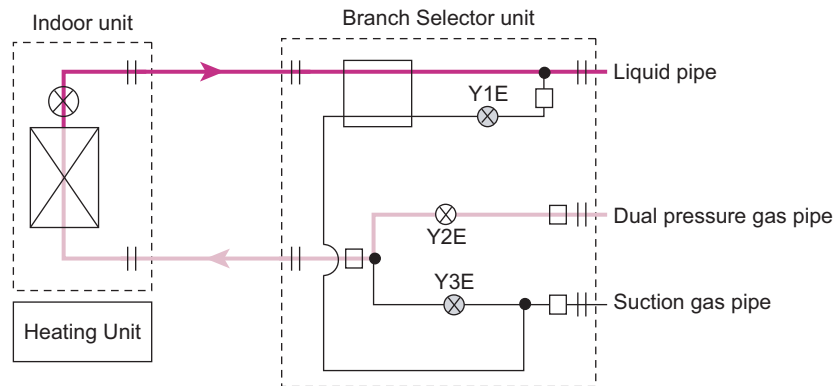

(2) In equalization

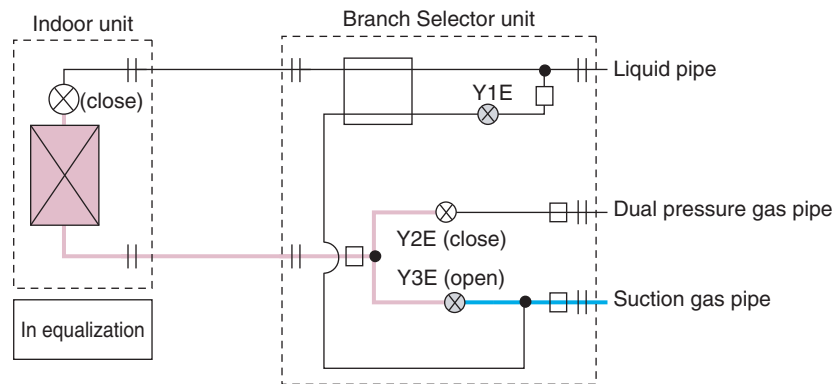

(3) To cooling

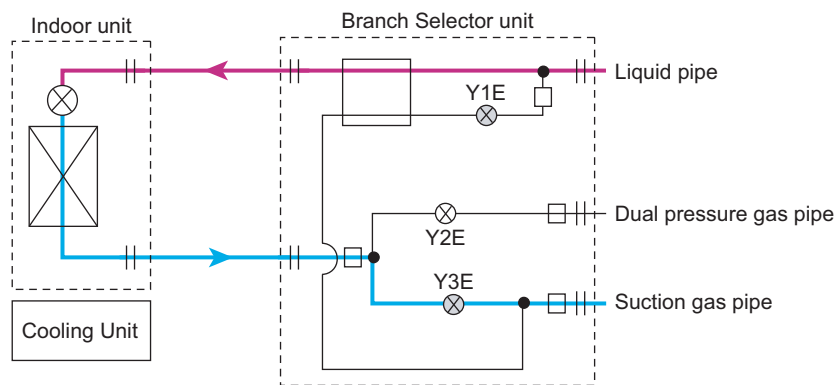

**While in all-room cooling operation → All-room cooling/heating simultaneous operation**

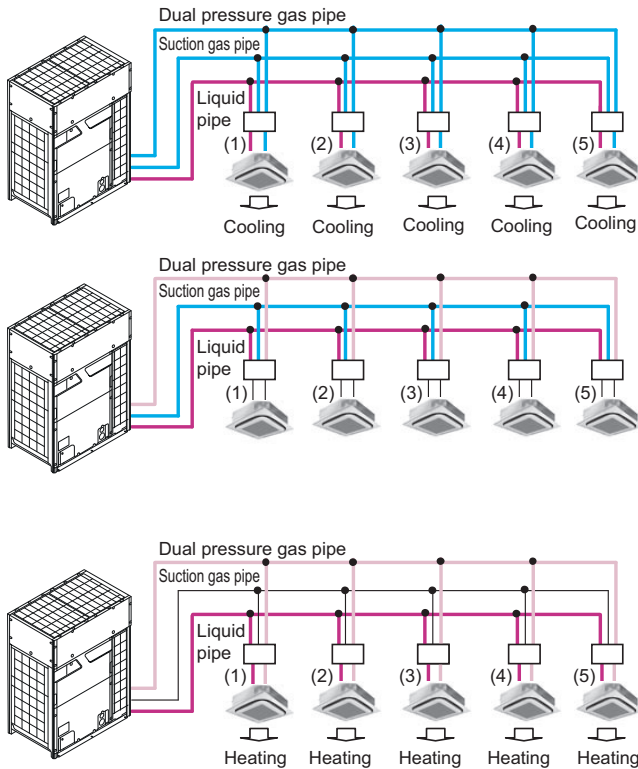

- (1) All the indoor units in cooling operation
  - ◆ Using the dual pressure gas pipe as a suction gas pipe.
- (2) Pump-down residual operation
- (3) Pre-startup control
  - ◆ Switching between the electronic expansion valves of branch selector unit.
  - ◆ Required switching time: 30 seconds (switching control time)  
(While switching: The compressor stops operating.)
- (4) Startup control
  - ◆ Switching the dual pressure gas pipe from low pressure to high pressure.
- (5) Into heating operation or cooling and heating simultaneous operation

Each indoor unit

- ◆ In warm air supply operation under cool air prevention control (for 3 to 5 minutes).

**While in all-room heating operation or cooling/heating simultaneous operation → All-room cooling**

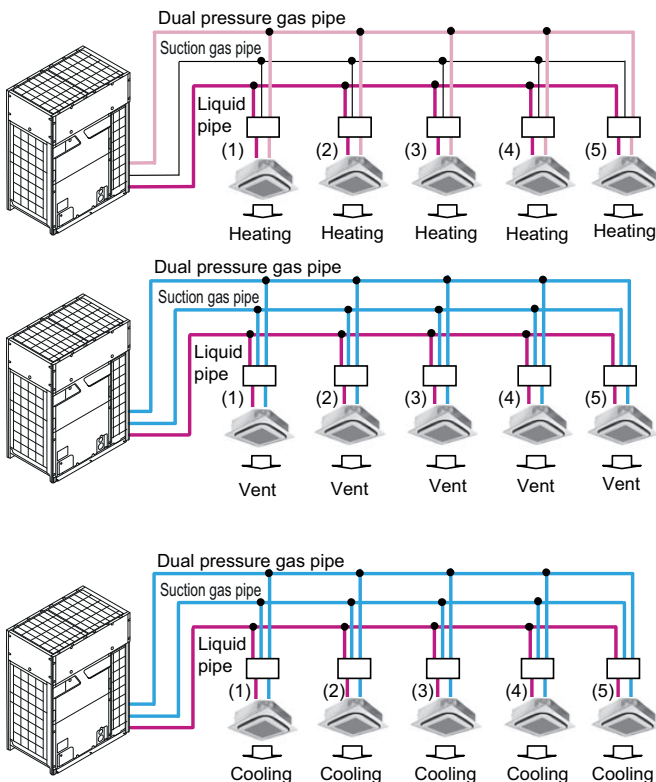

- (1) In heating operation or cooling and heating simultaneous operation
  - ◆ Using the dual pressure gas pipe as a suction gas pipe.
- (2) Pump-down residual operation
- (3) Pre-startup control
  - ◆ Switching between the electronic expansion valves of branch selector unit.
  - ◆ Required switching time: 2 to 4 minutes (switching control time)  
(While switching: The compressor stops operating.)
- (4) Startup control
  - ◆ Switching the dual pressure gas pipe from low pressure to high pressure.
- (5) Into all-unit cooling operation
  - ◆ In cool air supply operation

## 8. Other Control

### 8.1 Backup Operation

If any of the compressors goes wrong, disable the relevant compressor or the relevant outdoor unit from operating, and then conduct emergency operation only with operational compressors or outdoor units.

Emergency operation with remote controller reset and emergency operation with outdoor unit PCB setting are available.

#### (1) Emergency operation with remote controller reset

##### [Operating method]

Reset the remote controller. (Press the **ON/OFF** button for 4 seconds or more.)

##### [Details of operation]

Disable the defective outdoor unit from operating temporarily, and then only operate other outdoor units.

(On the system with 1 compressor, this emergency operation is not available.)

#### (2) Emergency operation with outdoor unit PCB setting

##### [Setting method]

Make setting of the unit, the operation of which is to be disabled, in field setting mode (setting mode 2).

##### [Details of operation]

Disable the defective outdoor unit from operating, and then only operate other outdoor units.

(On the system with 1 compressor, this emergency operation is not available.)

### 8.2 Demand Operation

In order to limit the power consumption, the capacity of outdoor unit is forcibly reduced by using Demand 1 Setting or Demand 2 Setting.

To operate the unit with this mode, additional setting of Continuous Demand Setting or external input by external control adaptor for outdoor unit is required.

Setting item	Content
Demand 1 (step 1)	The compressor operates at the power of 60-95% or less of the rating.
Demand 2 (step 2)	The compressor operates at the power of 40-55% or less of the rating.
Demand 3	Forced thermostat OFF



#### Reference

Refer to page 260 for the power consumption limitation details.

### 8.3 Heating Operation Prohibition

- When outdoor air temperature is too high, outdoor unit cannot operate in heating mode because:
  - Low pressure sensor can give pressure value above upper limit of sensor: error **JC**.
  - Mechanical internal load on compressor increases.
  - Low compression ratio can result in insufficient compressor internal oil lubrication.
- Heating is disabled when outdoor air temperature is above 26°C (78.8°F).
  - Forced thermostat-OFF on indoor units.
  - Outdoor fan operates at step 1.
- Heating operation is enabled when outdoor air temperature drops below 24°C (75.2°F).

# 9. Outline of Control (Indoor Unit)

## 9.1 Operation Flowchart

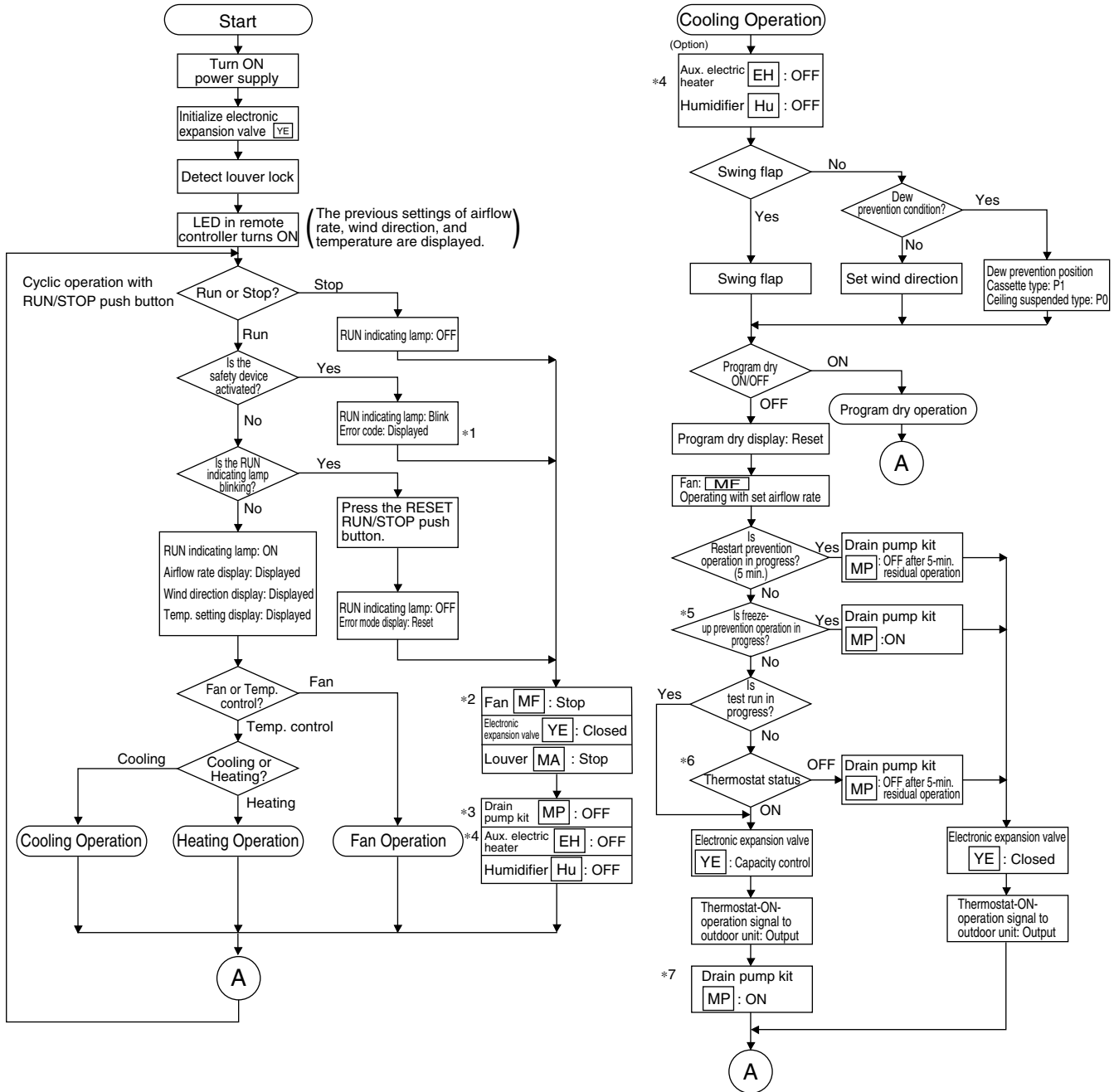

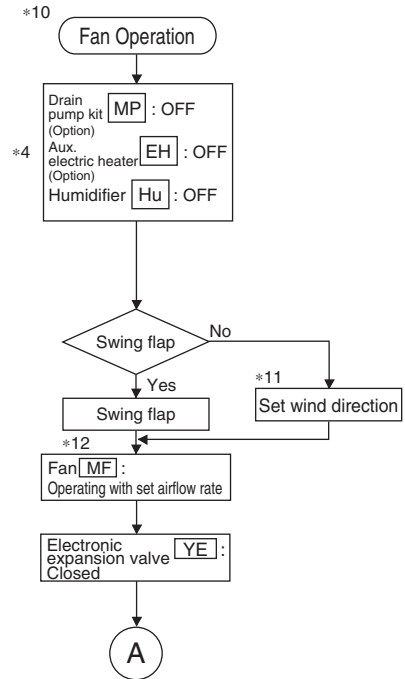
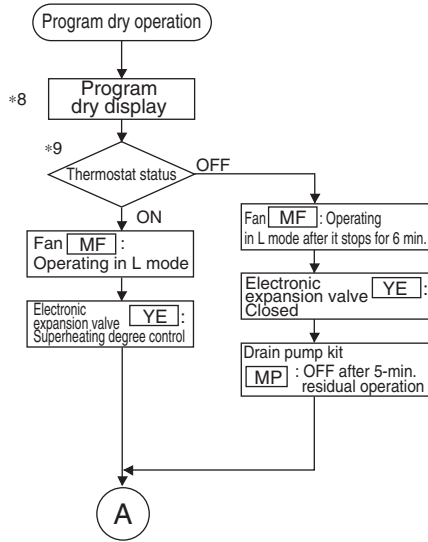



cumulative 10 min. or not more than  $-1^{\circ}\text{C}$  ( $30.2^{\circ}\text{F}$ ) for a cumulative period of 40 min., freeze-up prevention operation will be conducted. If the evaporator inlet temperature is kept at not less than  $7^{\circ}\text{C}$  ( $44.6^{\circ}\text{F}$ ) for a consecutive period of 10 min., the freeze-up prevention operation will be reset.

\*6. Thermostat status

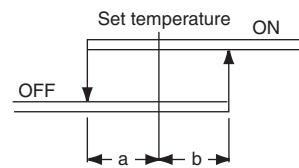

$a = b = 1^{\circ}\text{C}$  ( $1.8^{\circ}\text{F}$ ) or  $0.5^{\circ}\text{C}$  ( $0.9^{\circ}\text{F}$ )  
The values a and b depend on the field setting 12(22)-2.

\*7. The following models have the drain pump as standard equipment.

FXFQ-AA, FXFQ-T, FXZQ-TA, FXZQ-TB, FXUQ-P, FXUQ-PA, FXEQ-P, FXDQ-M, FXSQ-TA, FXSQ-TB, FXMQ-PB, FXMQ-TB

\*8. Program dry display

No set temperature and airflow rate of the remote controller are displayed.

\*9. Thermostat status

Set temperature when operating the program dry mechanism.

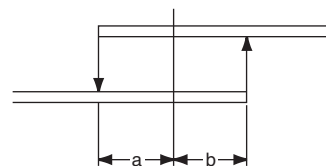

Suction air temperature

\*10. Fan operation

By setting the remote controller to Fan, the fan will operate with thermostat OFF in set temperature control operation mode.

\*11. Set wind direction

According to wind direction instruction from the remote controller, the wind direction is set to 100% horizontal while in heating operation.

\*12. Fan

According to fan speed instruction from the remote controller, the fan is put into operation in LL mode while in heating operation.

\*13. Wind direction

When the heating thermostat turns OFF, the wind direction will be set to 100% horizontal.

\*14. Hot start

After the start of heating operation or the end of defrost operation, the hot start control will terminate if the temperature at the condenser outlet (indoor heat exchanger liquid pipe temperature) exceeds  $34^{\circ}\text{C}$  ( $93.2^{\circ}\text{F}$ ), or if  $T_c$  is above  $52^{\circ}\text{C}$  ( $125.6^{\circ}\text{F}$ ), or if 3 minutes have elapsed.

\*15. Thermostat status

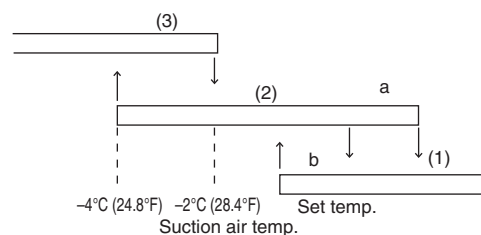

\*16. Outlet air temperature drop protection

When the set temperature is below  $24^{\circ}\text{C}$  ( $75.2^{\circ}\text{F}$ ) or the electronic expansion valve opening is small, the protection will be activated.

\*17. Hu indicates the Humidifier connected to the wiring modification adaptor.

It is not related to the Humidifier terminals on the PCB of FXTQ-TA, FXTQ-TB, or CXTQ-TA.

\*18. Only for CXTQ-TA.

Refer to **Gas Furnace Control (CXTQ-TA Models)** on page 200 for details.

## 9.2 Set Temperature and Control Target Temperature

### 9.2.1 Without Infrared Floor Sensor

The relationship between remote controller set temperature and control target temperature is described below.

- ◆ When the suction air thermistor is used for controlling (Default), the control target temperature is determined as follows to prevent insufficient heating in heating operation.  
Control target temperature = remote controller displayed temperature + 2°C (3.6°F)
- ◆ The temperature difference for cooling ⇔ heating mode switching is 5°C (9°F).
- ◆ The above also applies to automatic operation.

#### ■ When setting the suction air thermistor (Default setting)

Temperature		14 15 16 17 18 19 20 21 22 23 24 25 26 27 28 29 30 31 32 33 34 35°C
		57.2 59 60.8 62.6 64.4 66.2 68 69.8 71.6 73.4 75.2 77 78.8 80.6 82.4 84.2 86 87.8 89.6 91.4 93.2 95°F
Cooling	Remote controller set temperature	←-----●-----→
	Control target temperature	←-----●-----→
Heating	Remote controller set temperature	←-----●-----→
	Control target temperature	←-----●-----→

#### ■ When using the remote controller thermistor (Field setting is required)

Temperature		14 15 16 17 18 19 20 21 22 23 24 25 26 27 28 29 30 31 32 33 34 35°C
		57.2 59 60.8 62.6 64.4 66.2 68 69.8 71.6 73.4 75.2 77 78.8 80.6 82.4 84.2 86 87.8 89.6 91.4 93.2 95°F
Cooling	Remote controller set temperature	←-----●-----→
	Control target temperature	←-----●-----→
Heating	Remote controller set temperature	←-----●-----→
	Control target temperature	←-----●-----→

Examples are given to illustrate a control target temperature that satisfies the remote controller set temperature.



## 9.2.2 With Infrared Floor Sensor

The relationship between remote controller set temperature and control target temperature is described below.

- ◆ The temperature difference for cooling ⇔ heating mode switching is 5°C (9°F).
- ◆ When using the floor temperature as the control target, the remote controller set temperature is equal to the actual control target temperature in heating operation.
- ◆ The above also applies to automatic operation.

### ■ When setting the suction air thermistor (Default setting)

Temperature		14	15	16	17	18	19	20	21	22	23	24	25	26	27	28	29	30	31	32	33	34	35	36
		57.2	59	60.8	62.6	64.4	66.2	68	69.8	71.6	73.4	75.2	77	78.8	80.6	82.4	84.2	86	87.8	89.6	91.4	93.2	95	96.8
Cooling	Remote controller set temperature	←-----●-----→																						
	Control target temperature	←-----●-----→																						
Heating	Remote controller set temperature	←-----●-----→																						
	Control target temperature	←-----●-----→																						

### ■ When using the remote controller thermistor (Field setting is required)

Temperature		14	15	16	17	18	19	20	21	22	23	24	25	26	27	28	29	30	31	32	33	34	35	36
		57.2	59	60.8	62.6	64.4	66.2	68	69.8	71.6	73.4	75.2	77	78.8	80.6	82.4	84.2	86	87.8	89.6	91.4	93.2	95	96.8
Cooling	Remote controller set temperature	←-----●-----→																						
	Control target temperature	←-----●-----→																						
Heating	Remote controller set temperature	←-----●-----→																						
	Control target temperature	←-----●-----→																						

Examples are given to illustrate a control target temperature that satisfies the remote controller set temperature.

### Regarding control target temperature

When using the infrared floor sensor, the temperature around people will be treated as the control target temperature for operation.

### What is the temperature around people?

The temperature around people refers to the temperature of the living space, obtained from the temperature around the ceiling and the temperature underfoot. The temperature is calculated using the detected values of the suction air thermistor and the infrared floor sensor.

It is difficult to use only suction air temperature control for underfoot air conditioning.

### 9.3 Remote Controller Thermistor

Temperature is controlled by both the remote controller thermistor and suction air thermistor for the indoor unit. (This is however limited to when the field setting for the remote controller thermistor is set to Use.)



**Note(s)**

When fresh air intake kit is used, outdoor air is mixed with indoor air, and the room temperature may not reach the set temperature, since TS and TH1 do not enter the area in which remote controller thermistor can be used. In such case, install the remote sensor (optional accessory) in your room, and set the field settings to not use the remote controller thermistor.

\* FXTQ-TA, FXTQ-TB, and CXTQ-TA models do not have this control because they do not have suction air thermistor. The thermistor is selectable manually when remote sensor (optional accessory) is installed.

**Cooling**

If there is a significant difference in the set temperature and the suction temperature, fine adjustment control is carried out using a suction air thermistor, or using the remote controller thermistor near the position of the user when the suction temperature is near the set temperature.

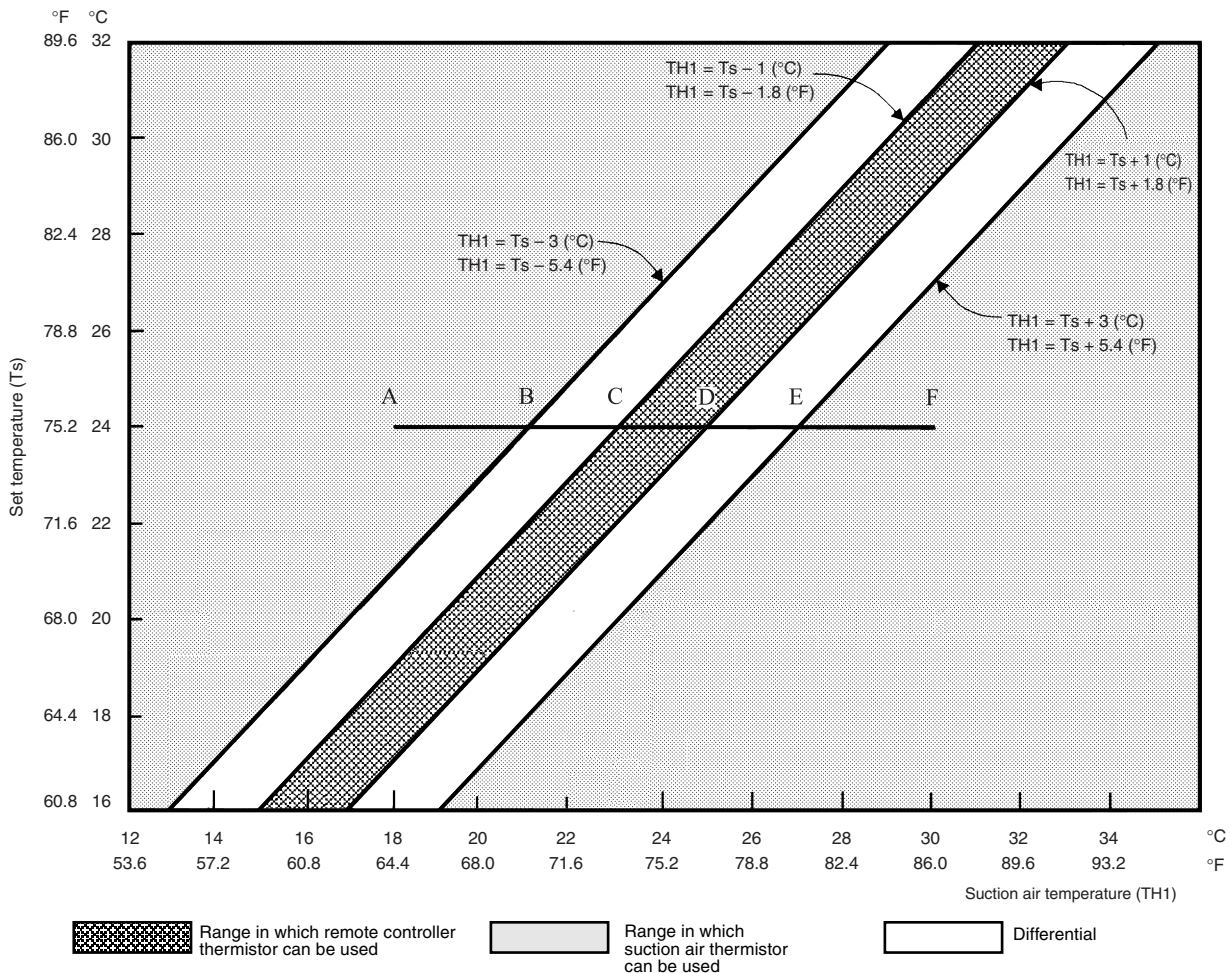

- Assuming the set temperature in the figure above is 24°C (75°F), and the suction temperature has changed from 18°C (64°F) to 30°C (86°F) (A → F):

(This example also assumes there are several other air conditioners, and the suction temperature changes even when the thermostat is off.)

Suction air thermistor is used for temperatures from 18°C (64°F) to 23°C (73°F) (A → C).

Remote controller thermistor is used for temperatures from 23°C (73°F) to 27°C (81°F) (C → E).

Suction air thermistor is used for temperatures from 27°C (81°F) to 30°C (86°F) (E → F).

- Assuming suction temperature has changed from 30°C (86°F) to 18°C (64°F) (F → A):**  
 Suction air thermistor is used for temperatures from 30°C (86°F) to 25°C (77°F) (F → D).  
 Remote controller thermistor is used for temperatures from 25°C (77°F) to 21°C (70°F) (D → B).  
 Suction air thermistor is used for temperatures from 21°C (70°F) to 18°C (64°F) (B → A).

**Heating**

When heating, the hot air rises to the top of the room, resulting in the temperature being lower near the floor where the occupants are. When controlling by suction air thermistor only, the indoor unit may therefore be turned off by the thermostat before the lower part of the room reaches the set temperature. The temperature can be controlled so the lower part of the room where the occupants are does not become cold by widening the range in which remote controller thermistor can be used so that suction temperature is higher than the set temperature.

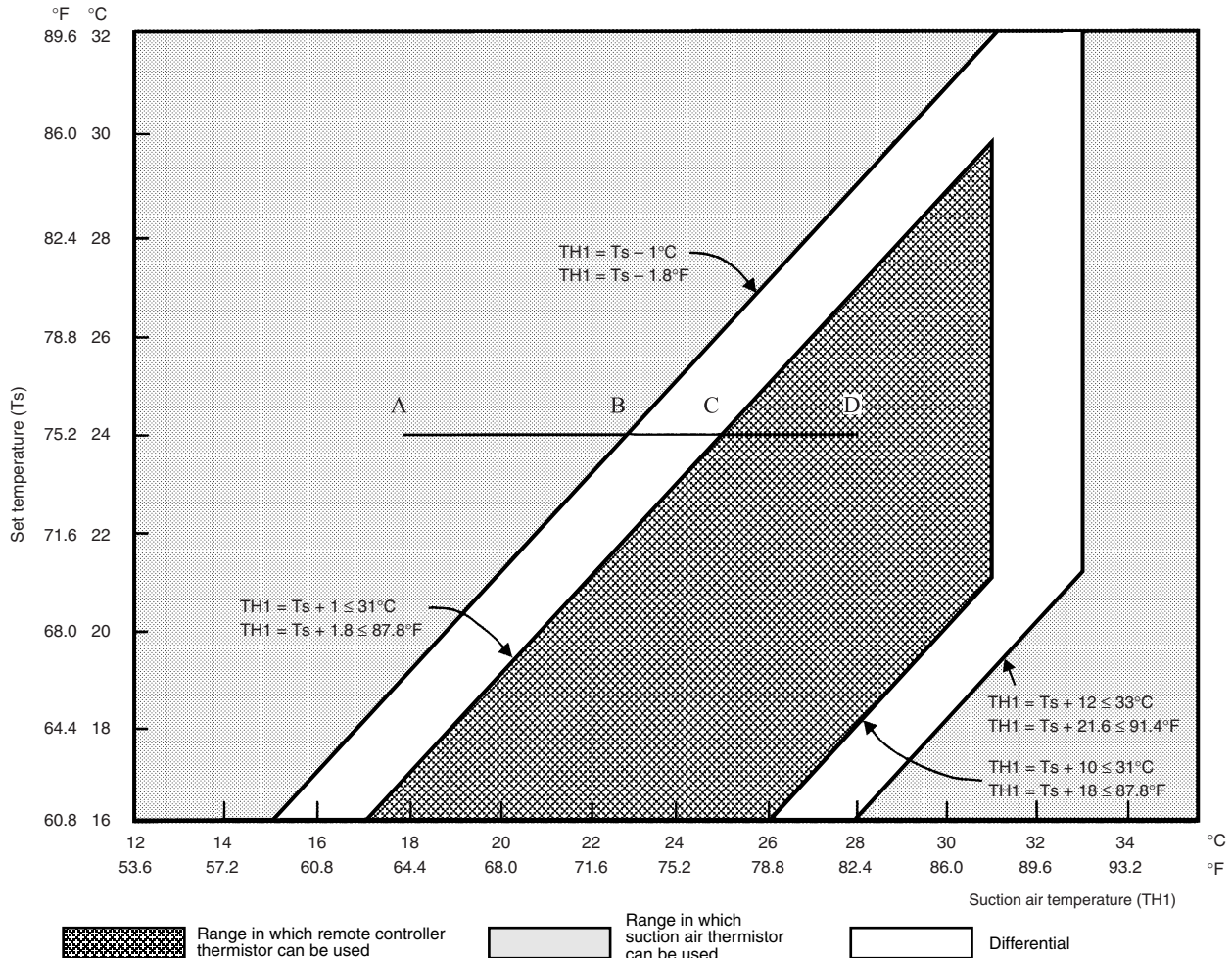

- Assuming the set temperature in the figure above is 24°C (75°F), and the suction temperature has changed from 18°C (64°F) to 28°C (82°F) (A → D):**  
 (This example also assumes there are several other air conditioners, and the suction temperature changes even when the thermostat sensor is off.)  
 Suction air thermistor is used for temperatures from 18°C (64°F) to 25°C (77°F) (A → C).  
 Remote controller thermistor is used for temperatures from 25°C (77°F) to 28°C (82°F) (C → D).
- Assuming suction temperature has changed from 28°C (82°F) to 18°C (64°F) (D → A):**  
 Remote controller thermistor is used for temperatures from 28°C (82°F) to 23°C (73°F) (D → B).  
 Suction air thermistor is used for temperatures from 23°C (73°F) to 18°C (64°F) (B → A).

## 9.4 Thermostat Control

The thermostat ON/OFF differential value (factory setting) differs depending on the models.

Differential value	Model
1°C (1.8°F)	FXFQ-T, FXZQ-TA, FXUQ-P, FXEQ-P, FXSQ-TA, FXHQ-M, FXTQ-TA, FXTQ-TB
0.5°C (0.9°F)	FXFQ-AA, FXZQ-TB, FXUQ-PA, FXDQ-M, FXSQ-TB, FXMQ-PB, FXMQ-TB, FXMQ-TA, FXMQ-M, FXAQ-P, FXLQ-M, FXNQ-M, FXMQ-MF, CXTQ-TA

### 9.4.1 Without Infrared Floor Sensor

Whether the thermostat is turned ON or OFF is determined by the difference between the remote controller set temperature and the actual detected room temperature (\*1).

#### Normal operation

- ♦ Cooling operation

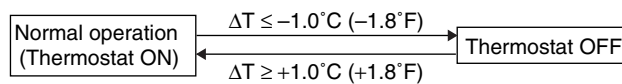

- ♦ Heating operation

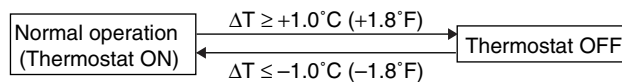

#### Dry operation

- ♦ When  $T_{ro} < 24.5^{\circ}\text{C}$  ( $76.1^{\circ}\text{F}$ )

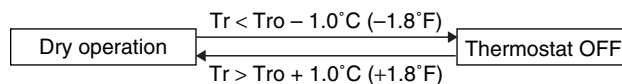

- ♦ When  $T_{ro} \geq 24.5^{\circ}\text{C}$  ( $76.1^{\circ}\text{F}$ )

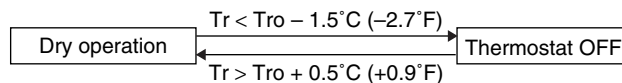

#### FXSQ-TB, FXMQ-TB, FXMQ-TA, FXTQ-TA, FXTQ-TB, CXTQ-TA only

If the field setting 11 (21)-12 (for FXSQ-TB, FXMQ-TB, FXMQ-TA) or 14 (24)-5 (for FXTQ-TA, FXTQ-TB, CXTQ-TA) is set to **02**,  $T_{ro}$  will be the same as the cooling set temperature.

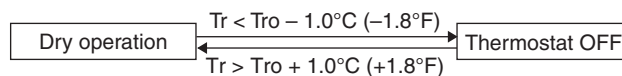

$\Delta T$  = Room temperature – Remote controller set temperature

$T_{ro}$ : Room temperature at the start of dry operation

$T_r$ : Room temperature

\*1: The thermistor for room temperature detection depends on the field setting 10 (20)-2.

## 9.4.2 With Infrared Floor Sensor

Whether the thermostat is turned on or off is determined by the difference between the remote controller set temperature and the detected temperature around people.

### Normal operation

- ♦ Cooling operation

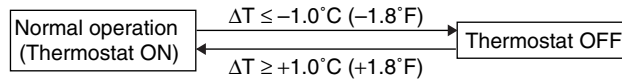

- ♦ Heating operation

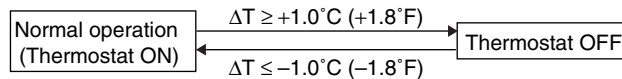

### Dry operation

- ♦ When  $T_{ro} \leq 24.5^{\circ}\text{C} (76.1^{\circ}\text{F})$

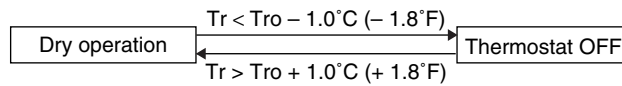

- ♦ When  $T_{ro} > 24.5^{\circ}\text{C} (76.1^{\circ}\text{F})$

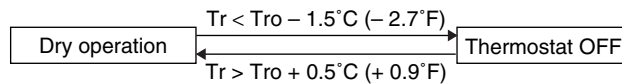

#### FXFQ-AA, FXZQ-TB, FXUQ-PA only

If the field setting 11 (21)-12 is set to **02**,  $T_{ro}$  will be the same as the cooling set temperature.

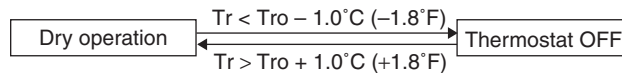

$\Delta T$  = Room temperature or temperature around people – Remote controller set temperature

$T_{ro}$ : Room temperature or temperature around people at the start of dry operation

$T_r$ : Room temperature or temperature around people

### Control range of temperature around people

When the floor temperature is very low, operation using the temperature around people may cause the suction air temperature to operate outside of use range.

To avoid the above condition, a limit based on the suction air temperature is set for the use range of the temperature around people.

#### Cooling operation

- ♦ When the floor temperature is lower than suction air temperature (R1T), R1T will be treated as the control target temperature for operation.
- ♦ When the temperature around people is  $15^{\circ}\text{C} (59^{\circ}\text{F})$  or lower, R1T will be treated as the control temperature for operation.

#### Heating operation

- ♦ When the floor temperature is higher than suction air temperature (R1T), R1T will be treated as the control target temperature in operation.
- ♦ When the temperature around people is  $33^{\circ}\text{C} (91.4^{\circ}\text{F})$  or higher, R1T will be treated as the control temperature for operation.

### 9.4.3 Thermostat Control with Operation Mode Set to AUTO

The system will conduct this temperature control shown below, only when the wireless remote controller or any central remote controller is connected.  
 Furthermore, setting changes of the differential value (D) can be made.

★: Factory setting

Mode No.	First code No.	Contents of setting	Second code No.							
			01★	02	03	04	05	06	07	08
12 (22)	4	Automatic mode differential	0°C 0°F ★	1°C 1.8°F	2°C 3.6°F	3°C 5.4°F	4°C 7.2°F	5°C 9.0°F	6°C 10.8°F	7°C 12.6°F

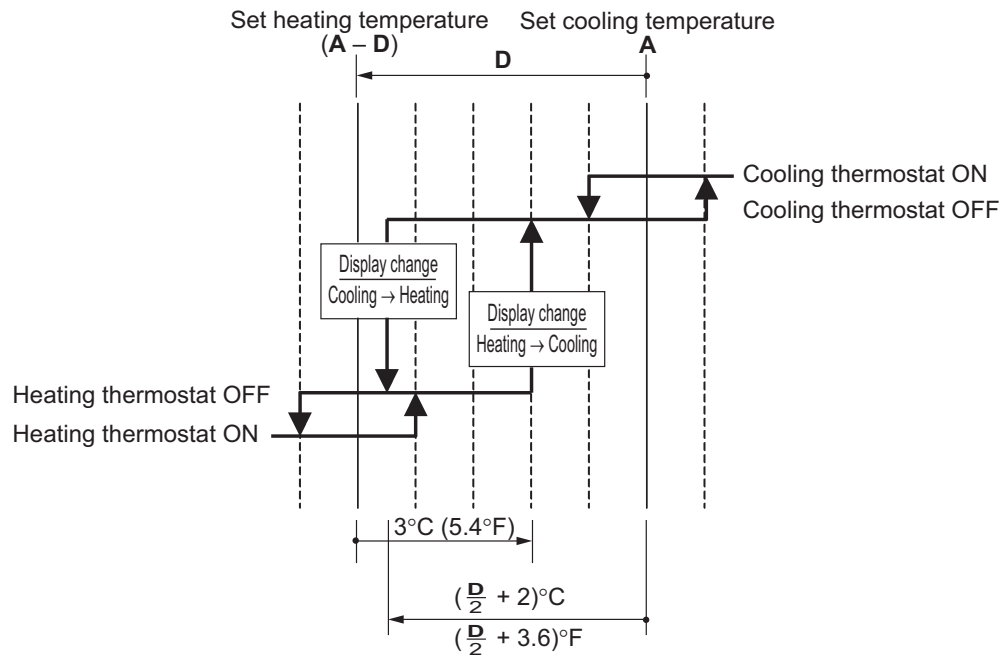

(Ex.) When automatic cooling temperature is set to 27°C (80.6°F):

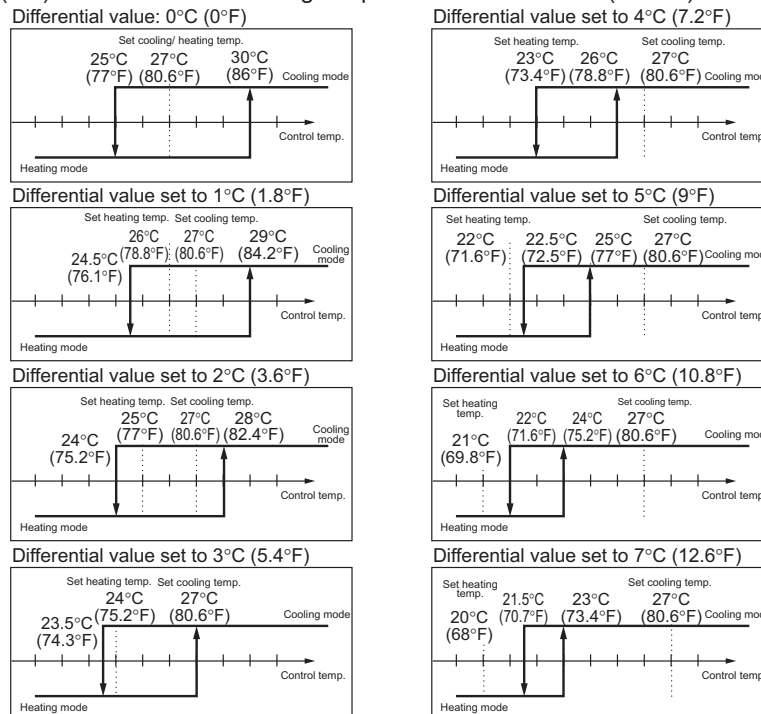

## 9.5 Drain Pump Control

### 9.5.1 Normal Operation

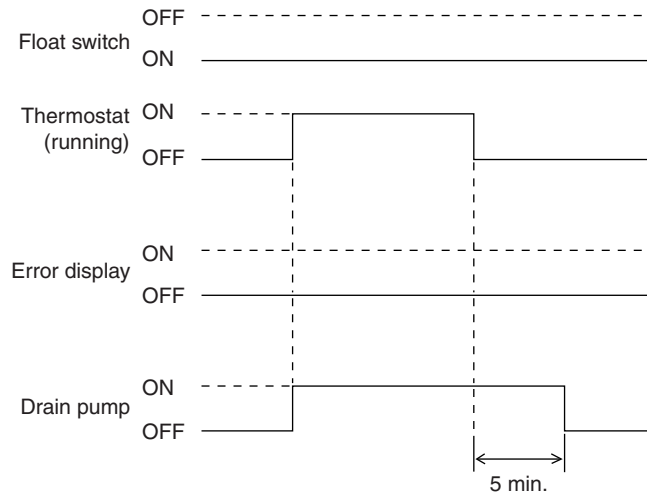

- The float switch is ON in normal operation.
- When cooling operation starts (thermostat ON), the drain pump turns ON simultaneously.
- After the thermostat turns OFF, the drain pump continues to operate for another 5 minutes.
- The aim of residual operation after thermostat OFF is to eliminate the dew that condenses on the indoor heat exchanger during cooling operation.

### 9.5.2 If the Float Switch is OFF with the Thermostat ON in Cooling Operation

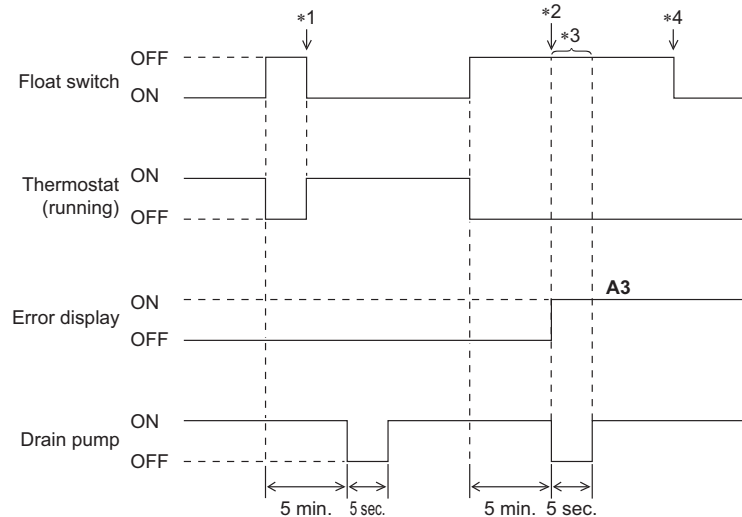

- When the float switch turns OFF, the thermostat turns OFF simultaneously.
- After the thermostat turns OFF, the drain pump continues to operate for another 5 minutes.
- \*1. If the float switch turns ON again during the residual operation of the drain pump, cooling operation also turns on again (thermostat ON).
- \*2. If the float switch remains OFF even after the residual operation of the drain pump has ended, the error code **A3** is displayed on the remote controller.
- \*3. The drain pump turns OFF once residual operation has ended, then turns ON again after 5 seconds.
- \*4. After **A3** is displayed and the unit comes to an abnormal stop, the thermostat will remain OFF even if the float switch turns ON again.

### 9.5.3 If the Float Switch is OFF with the Thermostat OFF in Cooling Operation

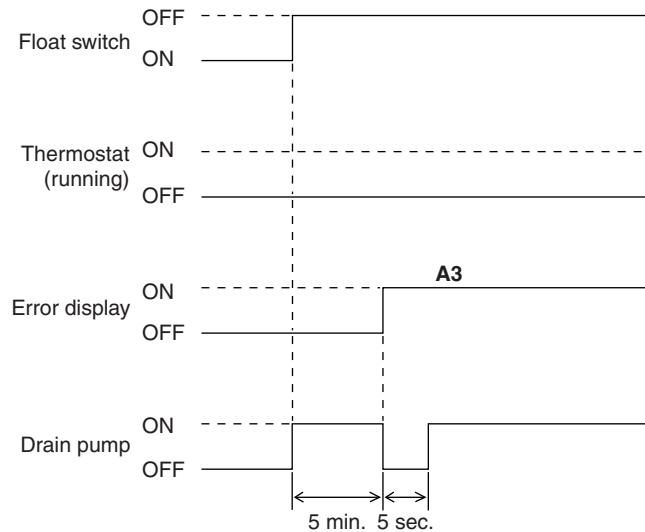

- When the float switch turns OFF, the drain pump turns ON simultaneously.
- If the float switch remains OFF even after residual operation of the drain pump has ended, the error code **A3** is displayed on the remote controller.
- The drain pump turns OFF once residual operation has ended, then turns ON again after 5 seconds.

### 9.5.4 If the Float Switch Turns OFF and ON Continuously, or the Float Switch Turns OFF While AF Displayed

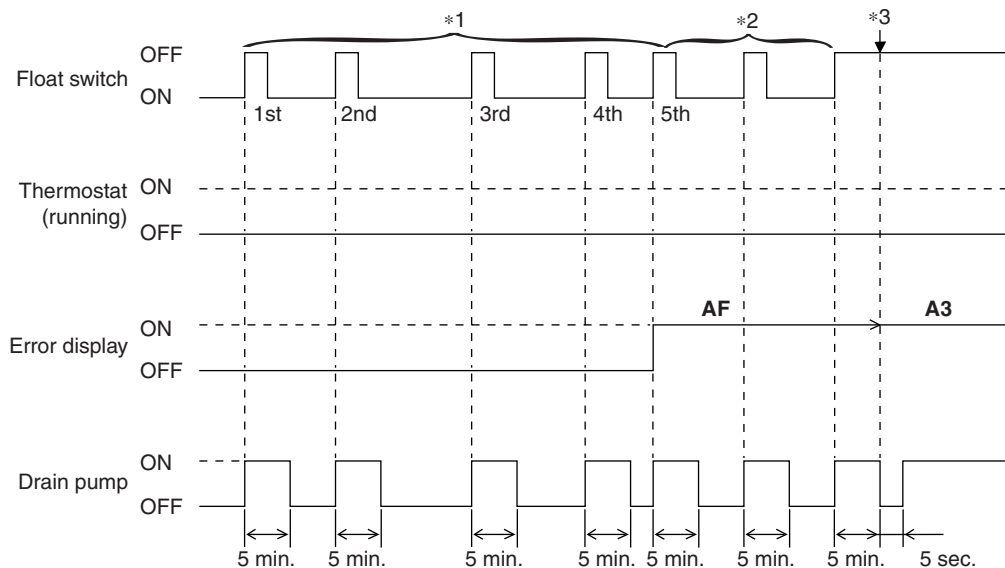

- When the float switch turns OFF, the drain pump turns ON simultaneously.
- \*1: If the float switch continues to turn OFF and ON 5 times consecutively, it is judged as a drain system error and the error code **AF** is displayed on the remote controller.
- \*2: The drain pump continues to turn ON/OFF in accordance with the float switch ON/OFF even after **AF** is displayed on the remote controller.
- \*3: While the error code **AF** is displayed, if the float switch remains OFF even after the residual operation of the drain pump has ended, the error code **A3** will be displayed on the remote controller.



## 9.6 Control of Electronic Expansion Valve

Electronic expansion valves in indoor units have the functions of conducting superheating degree control in cooling operation and subcooling degree control in heating operation. However, if the indoor units receive any control command such as a protection control command or a special control command from the outdoor unit, the units will give a priority to the control command.

### ● Superheating degree control in cooling operation

This function is used to adjust the opening of the electronic expansion valve so that superheating degree (SH), which is calculated from the detection temperature ( $T_g$ ) of the gas pipe thermistor (R3T) and the detection temperature (TI) of the liquid temperature thermistor (R2T) of the indoor unit, will come close to a target superheating degree (SHS).

At that time, correction to the superheating degree is made according to the differences ( $\Delta T$ ) between set temperature and suction air temperature.

$$SH = T_g - TI$$

Where,

SH: Evaporator outlet superheating degree

$T_g$ : Indoor unit gas pipe temperature (R3T)

TI: Indoor unit liquid pipe temperature (R2T)

SHS: Target superheating degree

SHS (Target SH value)

- ◆ Normally 5°C (9°F).
- ◆ As  $\Delta T$  (Remote controller set temp. – Suction air temp.) becomes larger, SHS becomes lower.
- ◆ As  $\Delta T$  (Remote controller set temp. – Suction air temp.) becomes smaller, SHS becomes higher.

### ● Subcooling degree control in heating operation

This function is used to adjust the opening of the electronic expansion valve so that the high pressure equivalent saturated temperature ( $T_c$ ), which is converted from the detected pressure of the high pressure sensor in the outdoor unit, and the subcooling degree (SC), which is calculated from the detected temperature (TI) of the liquid temperature thermistor (R2T) in the indoor unit, will come close to the target subcooling degree (SCS).

At that time, corrections to the subcooling degree are made according to differences ( $\Delta T$ ) between set temperature and suction air temperatures.

$$SC = T_c - TI$$

Where,

SC: Condenser outlet subcooling degree

$T_c$ : High pressure equivalent saturated temperature detected by the high pressure sensor (S1NPH)

TI: Indoor unit liquid pipe temperature (R2T)

SCS: Target subcooling degree

SCS (Target SC value)

- ◆ Normally 5°C (9°F).
- ◆ As  $\Delta T$  (Remote controller set temp. – Suction air temp.) becomes larger, SCS becomes lower.
- ◆ As  $\Delta T$  (Remote controller set temp. – Suction air temp.) becomes smaller, SCS becomes higher.

## 9.7 Freeze-Up Prevention Control

### Freeze-Up Prevention by Off Cycle (Indoor Unit)

When the temperature detected by the liquid pipe temperature thermistor of the indoor heat exchanger drops too low, the unit enters freeze-up prevention control in accordance with the following conditions, and is also set in accordance with the conditions given below. (Thermostat OFF)

When freeze-up prevention is activated, the electronic expansion valve is closed, the drain pump turns on and the airflow rate is fixed to L tap. When the following conditions for cancelling are satisfied, it will reset.

#### Conditions for starting:

Liquid pipe temperature  $\leq -1^{\circ}\text{C}$  ( $30.2^{\circ}\text{F}$ ) (for total of 40 minutes)

or

Liquid pipe temperature  $\leq -5^{\circ}\text{C}$  ( $23^{\circ}\text{F}$ ) (for total of 10 minutes)

#### Condition for cancelling:

Liquid pipe temperature  $\geq +7^{\circ}\text{C}$  ( $44.6^{\circ}\text{F}$ ) (for 10 minutes continuously)

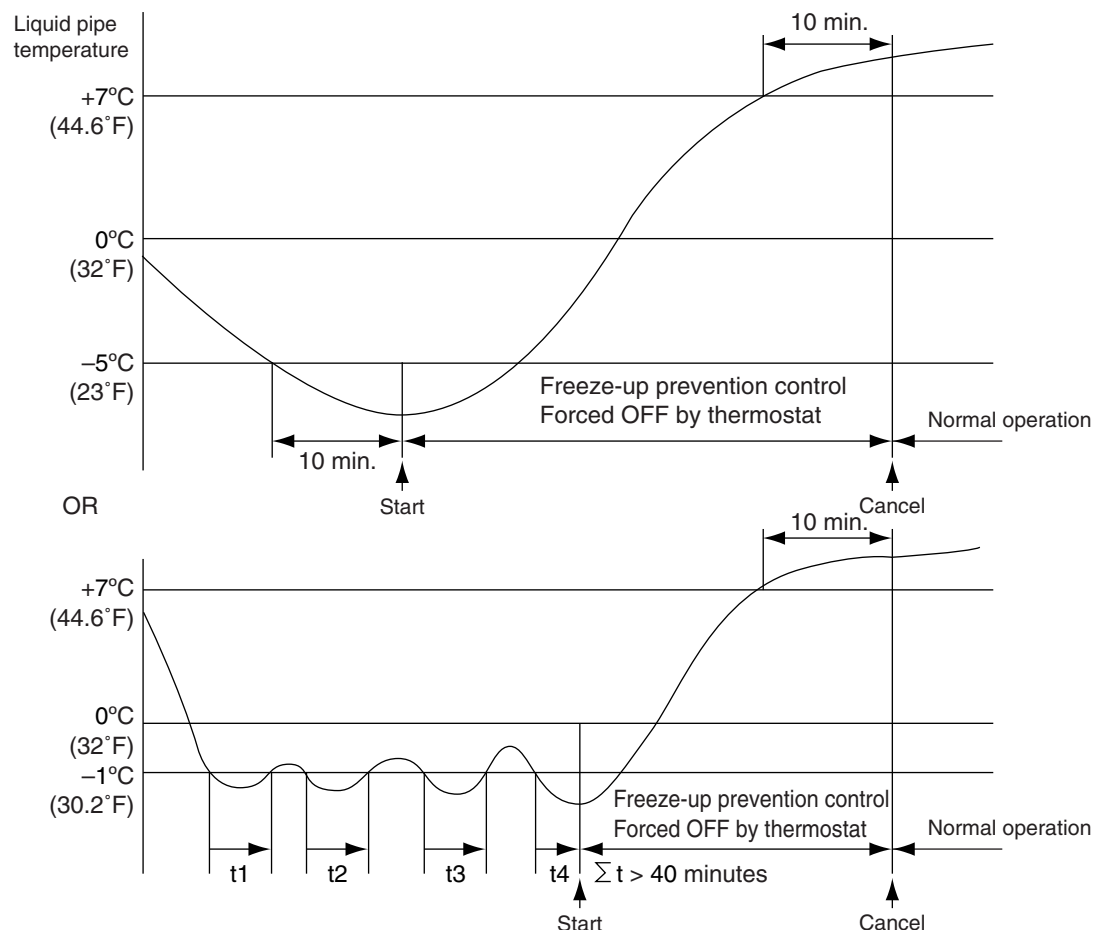

#### Concept of freeze-up prevention control

System avoids freeze-up

- For comfort, system avoids unnecessary thermostat ON/OFF
- For ensuring compressor reliability, system avoids unnecessary compressor ON/OFF

When freeze-up prevention control starts, system makes sure the frost is completely removed.

- System avoids water leakage.



**Note(s)**

When the indoor unit is FXFQ-AA, FXFQ-T, FXZQ-TA, FXZQ-TB, FXUQ-P, or FXUQ-PA, if the air outlet is set as dual-directional or tri-directional, the starting conditions will be changed as follows.  
Liquid pipe temperature  $\leq 1^{\circ}\text{C}$  (33.8 $^{\circ}\text{F}$ ) (for total of 15 minutes)

or

Liquid pipe temperature  $\leq 0^{\circ}\text{C}$  (32 $^{\circ}\text{F}$ ) (for 1 minute continuously)

During freeze-up prevention control, the airflow rate is fixed to LL.

(The cancelling conditions are same as the standard.)

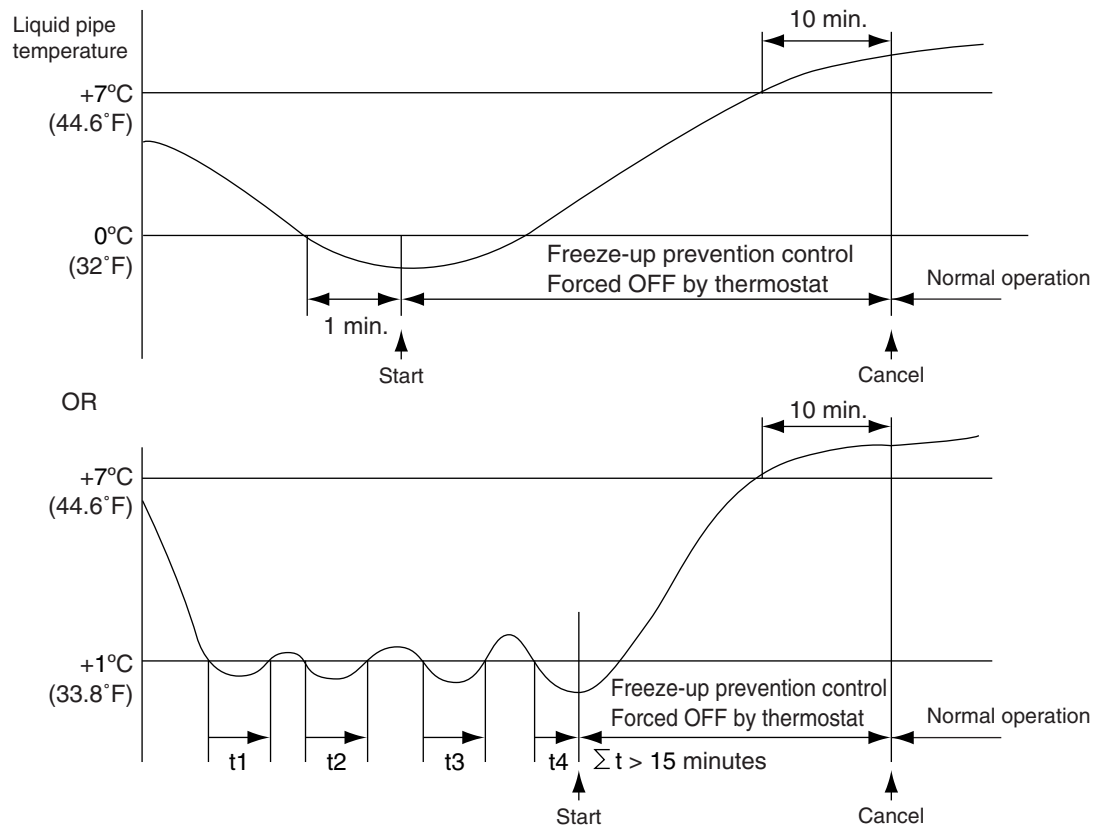

## 9.8 List of Swing Flap Operations

Swing flaps operate as shown in table below.

			Fan	Flap			
				FXFQ-AA FXFQ-T	FXEQ-P	FXHQ-M	FXZQ-TA FXZQ-TB FXUQ-P FXUQ-PA FXAQ-P
Heating	Hot start from defrost operation	Swing	OFF	Horizontal	Horizontal	Horizontal	Horizontal
		Airflow direction set	OFF	Horizontal	Horizontal	Horizontal	Horizontal
	Defrost operation	Swing	OFF	Horizontal	Horizontal	Horizontal	Horizontal
		Airflow direction set	OFF	Horizontal	Horizontal	Horizontal	Horizontal
	Thermostat OFF	Swing	LL	Horizontal	Horizontal	Horizontal	Horizontal
		Airflow direction set	LL	Horizontal	Horizontal	Horizontal	Horizontal
	Hot start from thermostat OFF mode (for prevention of cold air)	Swing	LL	Horizontal	Horizontal	Horizontal	Horizontal
		Airflow direction set	LL	Horizontal	Horizontal	Horizontal	Horizontal
	Stop	Swing	OFF	Horizontal	Horizontal	Horizontal	Totally closed
		Airflow direction set	OFF	Horizontal	Horizontal	Horizontal	Totally closed
Cooling	Thermostat ON in program dry	Swing	L (*1)	Swing	Swing	Swing	Swing
		Airflow direction set	L (*1)	Set	Set	Set	Set
	Thermostat OFF in program dry	Swing	OFF or L	Swing	Swing	Swing	Swing
		Airflow direction set		Horizontal or Set	Set	Set	Set
	Thermostat OFF in cooling	Swing	Set	Swing	Swing	Swing	Swing
		Airflow direction set	Set	Set	Set	Set	Set
	Stop	Swing	OFF	Horizontal	Horizontal	Horizontal	Totally closed
		Airflow direction set	OFF	Horizontal	Horizontal	Horizontal	Totally closed
	Microcomputer control (including cooling operation)	Swing	L	Swing	Swing	Swing	Swing
		Airflow direction set	L	Set	Set	Set	Set



**Note(s)** \*1. L or LL only on FXFQ-AA and FXFQ-T models

## 9.9 Hot Start Control (In Heating Operation Only)

At startup with thermostat ON or after the completion of defrosting in heating operation, the indoor fan is controlled to prevent cold air from blasting out and ensure startup capacity.

TH2: Temperature detected with the gas thermistor

Tc: High pressure equivalent saturated temperature

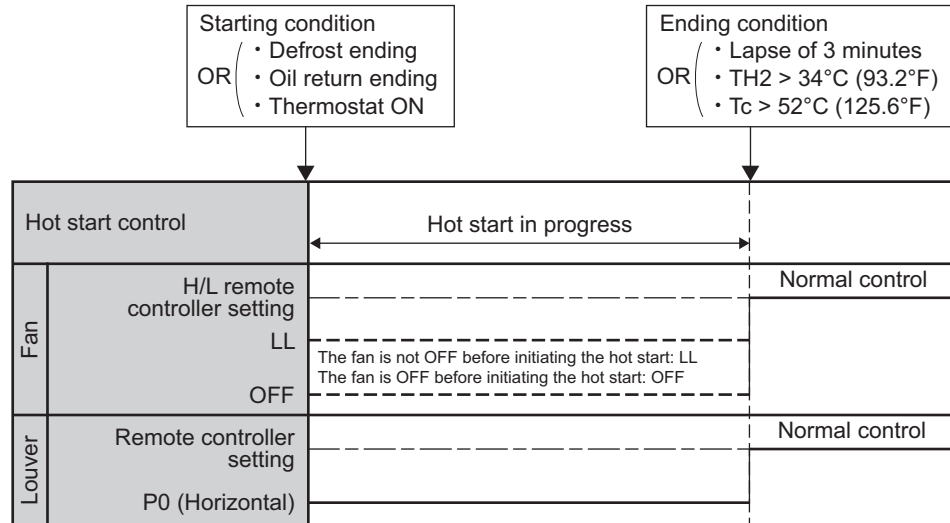

■ FXTQ-TA, FXTQ-TB (when the heater is to be used)

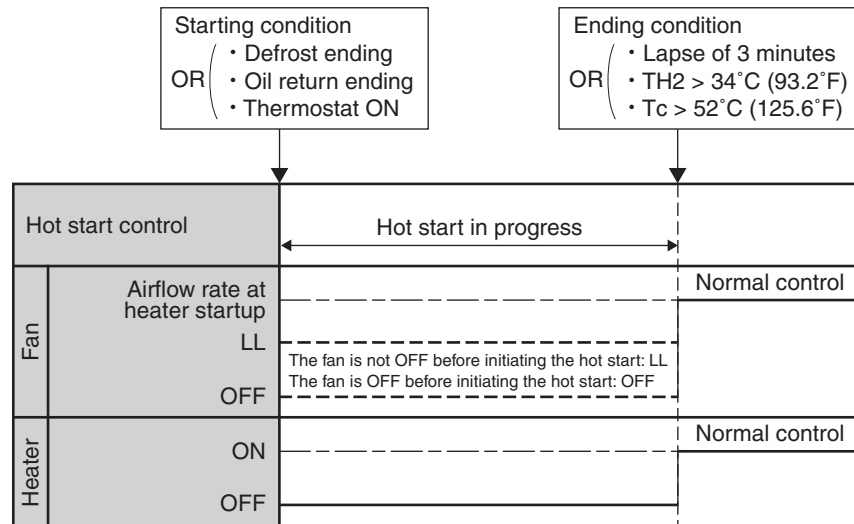

## 9.10 Louver Control for Preventing Ceiling Dirt

We have added a control feature that allows you to select the range of in which air direction can be adjusted in order to prevent the ceiling surrounding the air discharge outlet of ceiling mounted cassette type units from being soiled. (This feature is available on FXFQ-AA, FXFQ-T, FXZQ-TA, FXZQ-TB and FXEQ-P models)

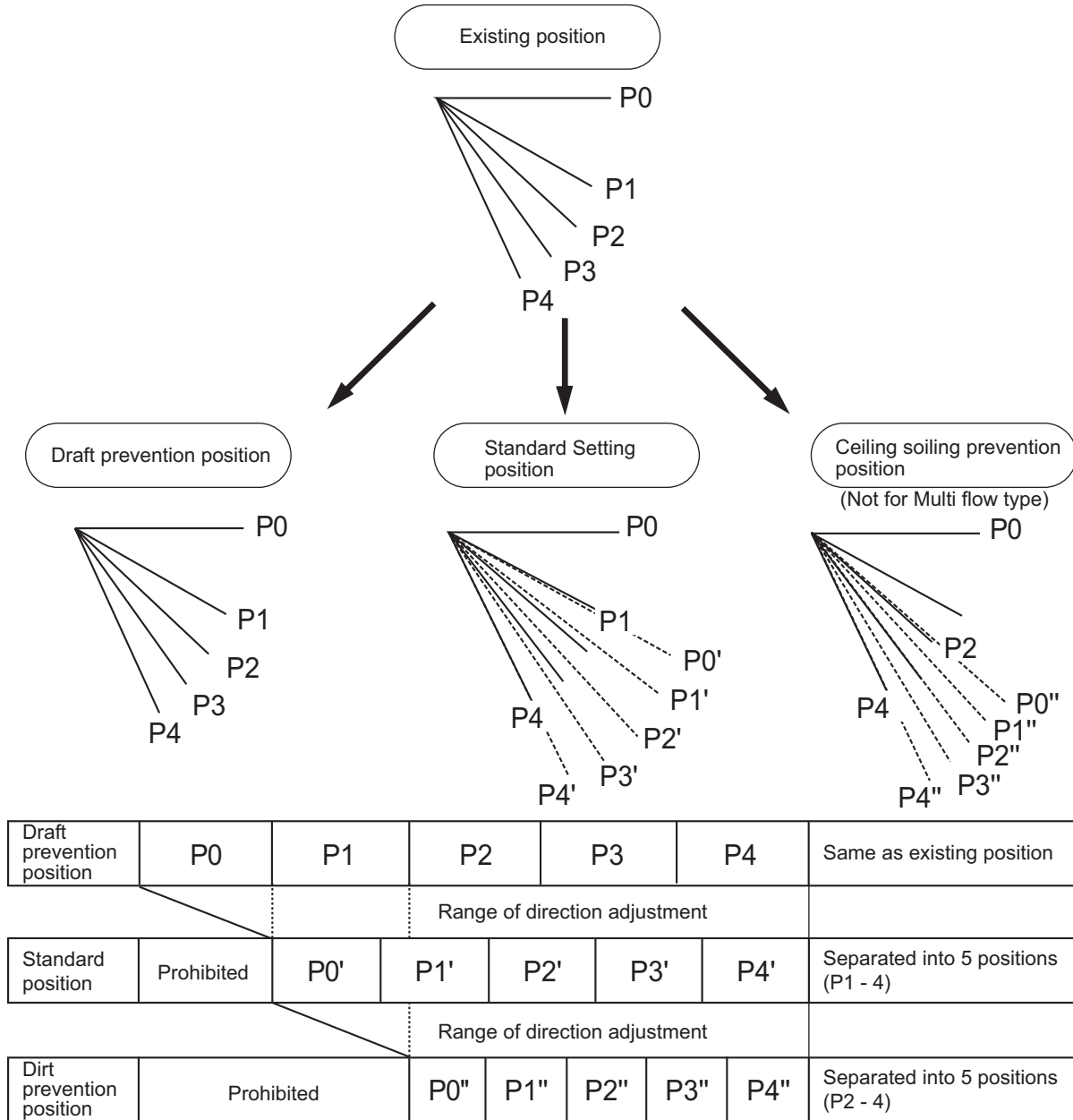

Factory setting

FXFQ-AA, FXFQ-T models: draft prevention position

FXZQ-TA, FXZQ-TB, FXEQ-P models: standard position

## 9.11 Heater Control (Except FXTQ-TA, FXTQ-TB Models)



**Note(s)** Optional PCB KRP1B... is required.

The heater control is conducted in the following manner.

### Normal control

While in heating, the heater control (ON/OFF) is conducted as shown below.

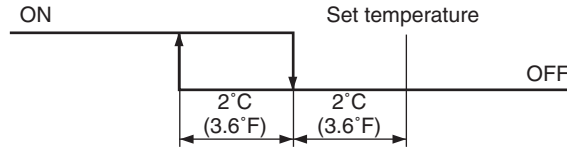

### Overload control

When the system is overloaded in heating, the heater will be turned OFF in the following 2 manners.

1. The heater control (ON/OFF) is conducted through the liquid pipe temperature (R2T) of the indoor unit.

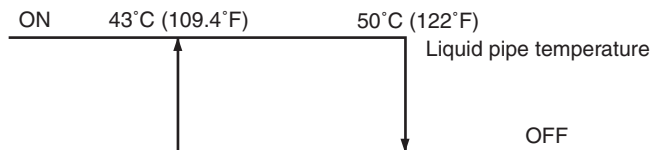

2. The heater control (ON/OFF) is conducted by converting the heater temperature into the condensing pressure equivalent saturated temperature (Tc) according to the temperature detection through the high pressure sensor (S1NPH) of the outdoor unit.

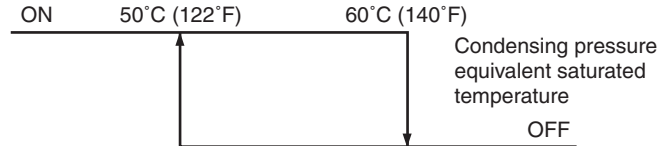

### Fan residual operation

While the heater turns OFF, in order to prevent the activation of the thermal protector, the fan conducts residual operation for a given period of time after the heater turns OFF. (This operation is conducted regardless of with or without heater equipped.)

Residual operation time: 100 seconds on ceiling suspended type or 60 seconds on other types

## 9.12 Heater Control (FXTQ-TA, FXTQ-TB Models)



**Note(s)**

Optional heater kit HKS... is required.

For FXTQ-TA and FXTQ-TB models, heater ON/OFF output from wiring adaptor interlocks with the operation of heater kit HKS...(When the heater 1 turns ON/OFF, heater output of wiring adaptor turns ON/OFF.). Fan residual operation also interlocks with the fan residual operation of heater kit HKS.... The residual time will be 90 seconds. (Refer to **Fan Control (Heater Residual) (FXTQ-TA, FXTQ-TB Models)** on page 202.)

### 9.12.1 Auxiliary Electric Heater Control

If heating is insufficient in heat pump system alone, an electric heater is to be used as the auxiliary heater. The following shows the ON/OFF conditions for the electric heater.

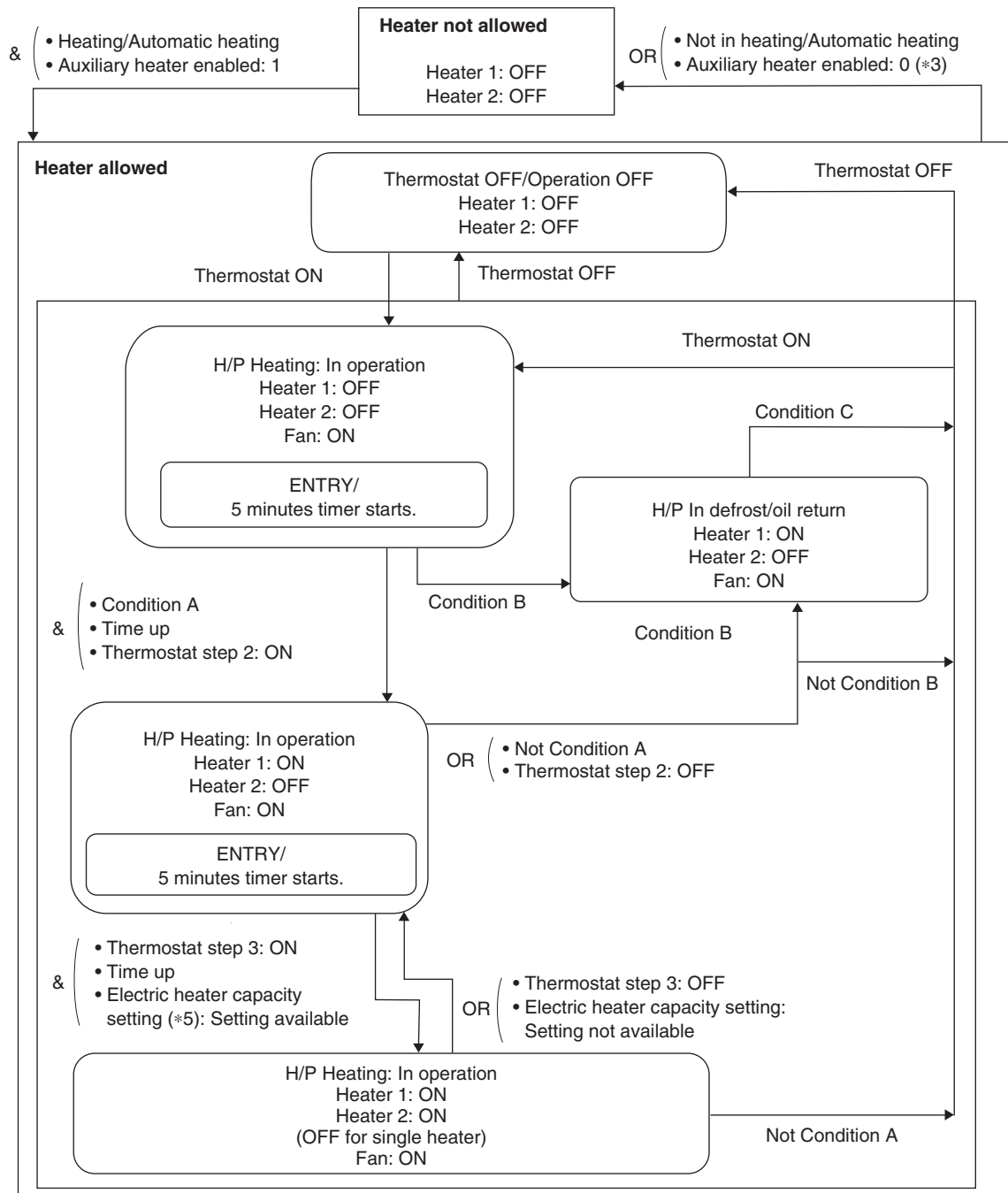



## Condition A

- No fan motor system error
  - High pressure condition: ON (\*1)
  - Liquid pipe temperature condition: ON (\*2)
- & (
- OR (
  - & (
  - Heater ON permission (Defrost/oil Return): 0 (\*4)
  - Not during defrost/oil return
  - Heater ON permission (Defrost/oil return): 1 (\*4)

## Condition B

- No fan motor system error
  - During defrost/oil return
  - Heater ON permission (Defrost/oil return): 1 (\*4)
- & (

## Condition C

- Not during defrost/oil return
  - Fan motor system error
  - Heater ON permission (Defrost/oil return): 0 (\*4)
- OR (

 Note(s)

## \*1: High pressure condition

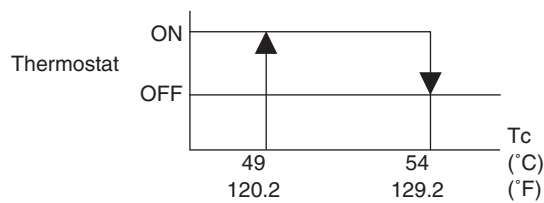

## \*2: Liquid pipe temperature condition



## \*3. Auxiliary heater enabled

- 1: & (
- Electric heater setting (Field setting 11 (21)-3.): **02, 08** (\*6)
  - Electric heater capacity setting  $\neq$  **01**
- 0: Other than the above

## \*4. Heater ON permission (Defrost/oil return)

- 1: Electric heater setting (Field setting 11 (21)-3.): **08** (\*6)
- 0: Electric heater setting (Field setting 11 (21)-3.): **02** (\*6)

## \*5. Field setting 11(21)-5. Refer to page 222.

## \*6. Field setting 11(21)-3. Refer to page 222.

### 9.12.2 Heat Pump Lockout Control

For heating operation, users can select to use electric heater. For this, signals are sent using ABC terminal of outdoor unit PCB.

When the hot-water heating signal is received from the outdoor unit PCB, heating operation is performed only with the electric heater as manual backup operation. The ON/OFF conditions for the electric heater are shown below.

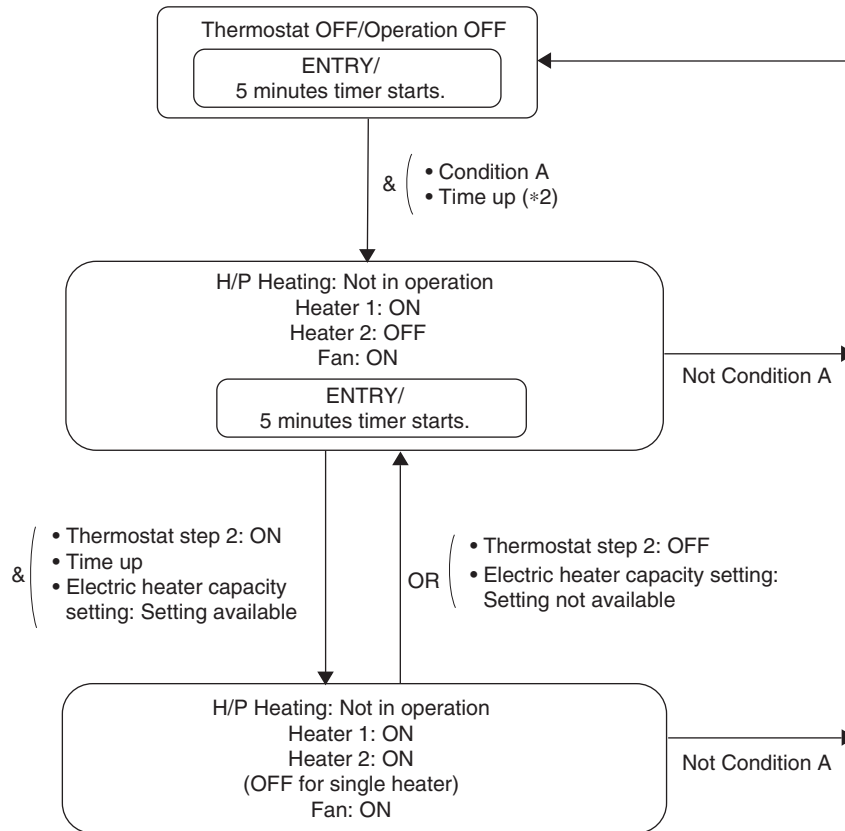

Condition A

- Heating or automatic heating mode
- Thermostat step 1: ON
- No fan motor system error
- Hot-water heater: 1 (ON)
- Heater backup prohibiting conditions (\*1) not met (Not Condition B)

Condition B: Heater backup prohibiting conditions (\*1)

- Indoor unit error (Abnormal stop)
- Indoor unit error (Remote controller thermistor error)
- Indoor unit error (Remote sensor error)
- Electric heater capacity setting: 01 (No heater kit)

**i** Note(s)

- \*1. The heater backup prohibiting conditions are prioritized. Even when the heater ON conditions are met, the heater is turned OFF when the prohibiting conditions are met.
- \*2. When the remote controller is ON, Time-up will be set to the initial value.

## 9.13 Gas Furnace Control (CXTQ-TA Models)

### Outline

When conditions for gas furnace operation are established, the system transits into gas furnace operation, CXTQ-TA requires the gas furnace combustion heating.

### Detail

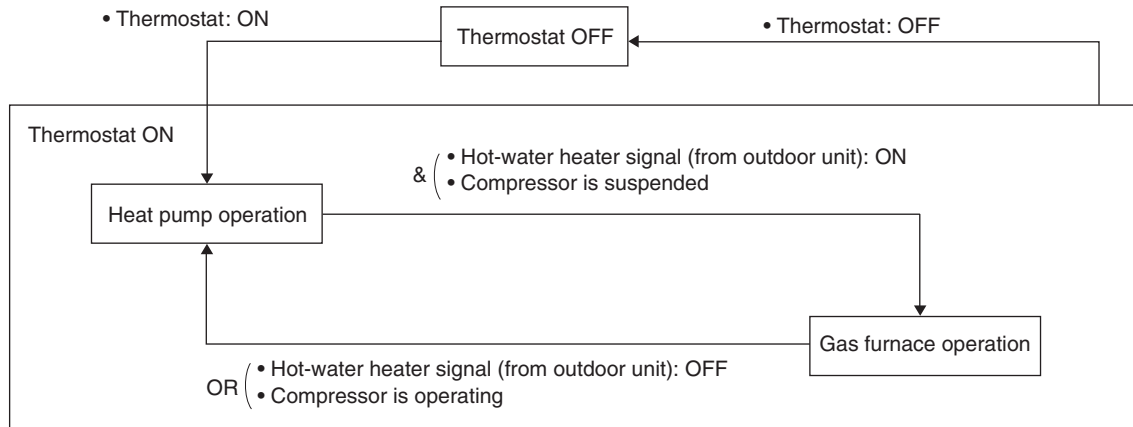

### Note(s)

The airflow rate during gas furnace operation depends on the intensity of combustion heating and therefore may be different from the airflow setting displayed on the remote controller.

## 9.14 3-Step Thermostat Processing (FXTQ-TA, FXTQ-TB Models)

### Outline

The thermostat ON/OFF for the indoor unit is controlled in accordance with Thermostat step 1. The heater ON/OFF operation during heating is controlled as follows.

Thermostat step 2, 3: Auxiliary electric heater control  
 Thermostat step 1, 2: Heat pump lockout control

For more details of the heater, refer to **Heater Control (FXTQ-TA, FXTQ-TB Models)** on page 197.

### Detail

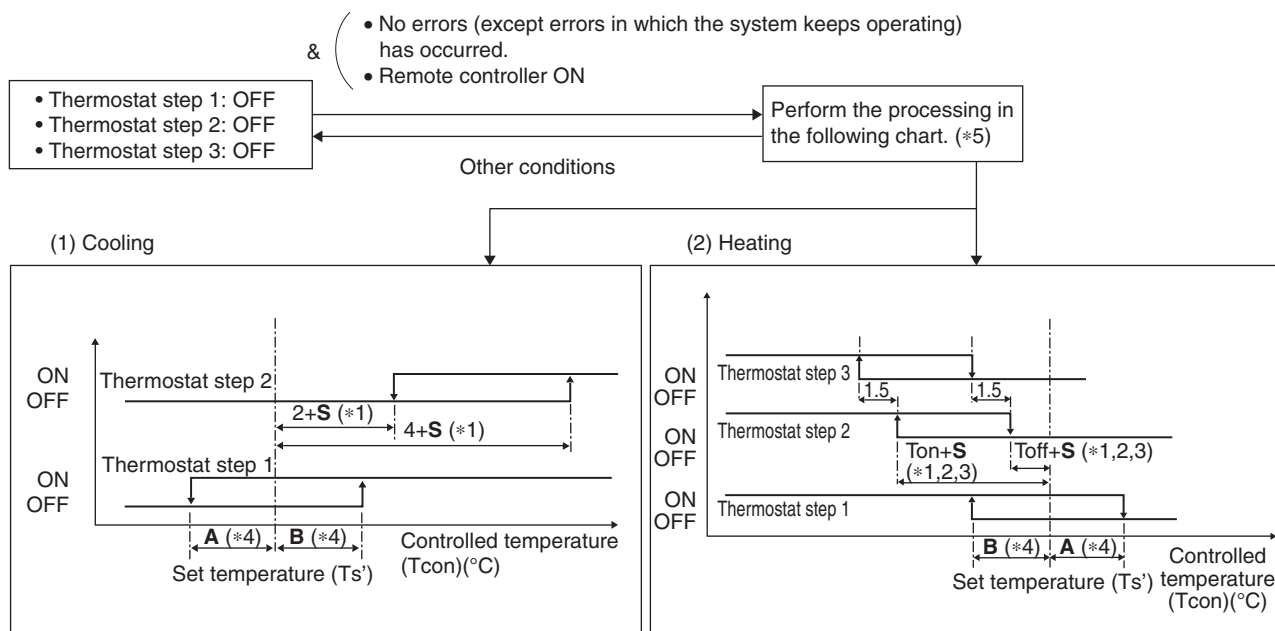

#### Note(s)

- \*1. **S** value varies automatically based on the room temperature trend.
- \*2.  $T_{on} + S > -B$  ( $^{\circ}C$ ),  $T_{off} + S < A$  ( $^{\circ}C$ )
- \*3. For parameters, refer to page 220.
- \*4. **A** and **B** values vary automatically based on the field setting 12 (22)-2.
- \*5. If, directly after a change in conditions, it is such that the thermostat could be either ON or OFF (controlled temperature is within ranges **A** and **B**), the thermostat will be switched to ON.

## 9.15 Fan Control (Heater Residual) (FXTQ-TA, FXTQ-TB Models)

### Outline

If the indoor heater turned OFF from ON during heating operation, the fan will keep operating for further period of time in order to cool the heater.

### Detail

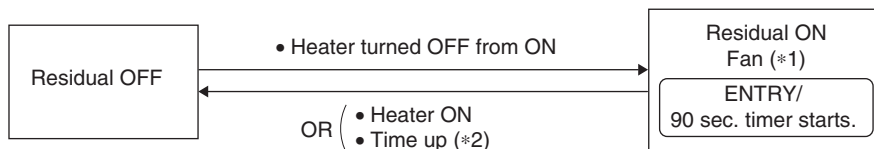

- \*1. When the heater is ON, the airflow rate of the fan will be whichever is the largest between the CFM dictated by the heater's own capacity, or the fan tap CFM determined by other controls.
- \*2. Fan residual operation will continue, even if the indoor unit is turned off with the remote controller operation button.

## 9.16 Interlocked with External Equipment (FXTQ-TA, FXTQ-TB, CXTQ-TA Models)

### 9.16.1 Air Purifier (UV Lamp)

When an air purifier is connected onsite, the fan is operated with the airflow rate set of the remote controller or with the H tap.



- \*1. External input ON is an input signal to the X1M-AIR CLEANER terminal on the PCB.

### 9.16.2 Humidifier

When a humidifier is connected onsite, the fan operates with the airflow rate set of the remote controller or with the H tap.

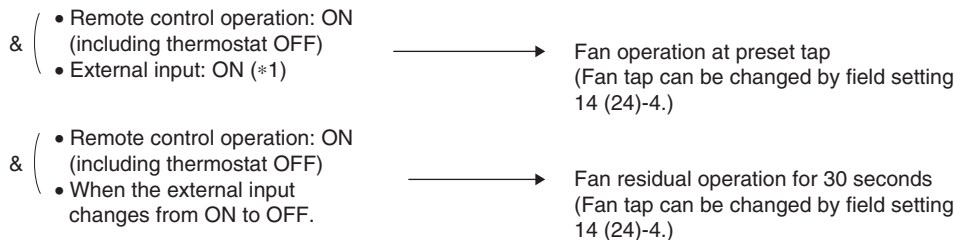

- \*1. External input ON is an input signal to the X1M-HUMIDIFIER terminal on the PCB.



#### Note(s)

This control is not applicable to the humidifier connected to the wiring adaptor, but to the humidifier connected to HUMIDIFIER on the X1M terminal of the indoor unit PCB.

### 9.16.3 Economizer

When indoor and outdoor air temperatures are reversed, the compressor is stopped to let in the outdoor air to save energy. This operation is called economizer operation, and the equipment to detect indoor and outdoor air temperatures and open and close the damper to perform this operation is called an economizer. The economizer detects indoor and outdoor air temperatures, informs the air conditioner that the economizer operation is ready, and opens and closes the damper. The indoor unit stops the outdoor unit when it receives a signal from the economizer and performs air supply operation. When the indoor air temperature is cooled down sufficiently by the economizer operation, and it is no longer necessary (thermostat OFF), the indoor unit outputs a signal to the economizer to close the damper.

#### ■ Thermostat ON signal

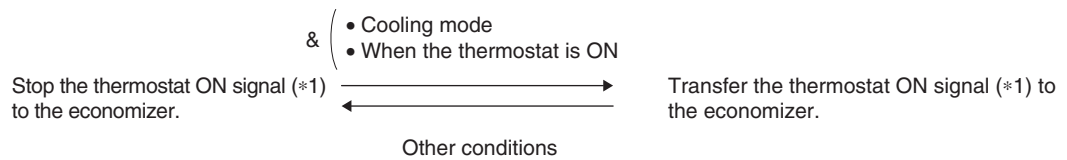

#### ■ Operation

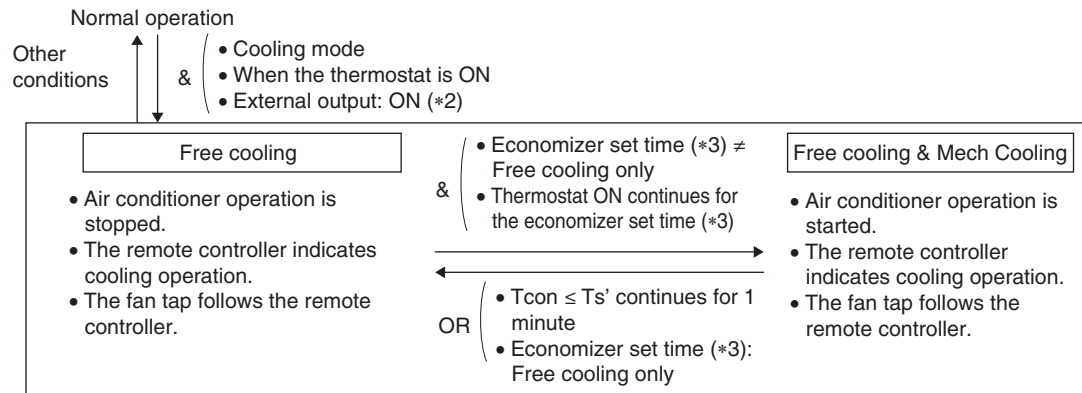

#### ■ Indoor unit ON signal

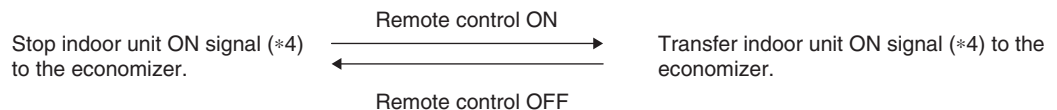

#### **i** Note(s)

- \*1. Thermostat ON signal: A signal to turn ON the indoor unit thermostat and allow the economizer to open the damper. It turns ON the relay on the X2M-ECONOMIZER2 on the PCB.
- \*2. External input ON is an input signal to the X1M-ECONOMIZER1 terminal on the PCB.
- \*3. Refer to **Optional Kit Setting (UV lamp + Humidifier + Economizer) (for FXTQ-TA, FXTQ-TB, CXTQ-TA models)** on page 232.
- \*4. Remote control ON signal: Contact output which shows the operating status of the indoor unit. This signal turns on the relay X2M-CONTROL ON/OFF on the PCB.

# Part 5

# Field Settings and

# Test Operation

1. Field Settings for Indoor Unit.....	205
1.1 Field Settings with Remote Controller .....	205
1.2 List of Field Settings for Indoor Unit .....	211
1.3 Applicable Field Settings .....	213
1.4 Details of Field Settings for Indoor Unit.....	217
1.5 Gas Furnace Set Up.....	236
1.6 List of Field Settings for Outdoor-Air Processing Unit .....	237
1.7 Operation Control Mode .....	237
2. Field Setting from Outdoor Unit.....	239
2.1 DIP Switch Setting when Mounting a Spare PCB .....	239
2.2 Accessing the BS Buttons on the PCB.....	241
2.3 Operating the BS Buttons and DIP Switches on the PCB.....	242
2.4 Connecting the PC Configurator to the Outdoor Unit .....	245
2.5 Monitoring Function and Field Settings .....	245
2.6 Cool/Heat Mode Changeover.....	270
2.7 Night-Time Low Noise Operation and Demand Operation .....	271
2.8 Energy Saving and Optimum Operation.....	276
3. Field Settings for Branch Selector Unit .....	279
3.1 Field Settings for Single Branch Selector Unit .....	279
3.2 Field Settings for Multi Branch Selector Unit (Standard Series).....	280
3.3 Field Settings for Multi Branch Selector Unit (Flex Series) .....	281
3.4 How to Check Miswiring for Multi Branch Selector Unit .....	283
4. Test Operation .....	284
4.1 Checks before Test Operation .....	284
4.2 Checkpoints.....	284
4.3 Gas Furnace Test Operation.....	285

# 1. Field Settings for Indoor Unit

## 1.1 Field Settings with Remote Controller

Individual function of indoor unit can be changed from the remote controller. At the time of installation or after service inspection / repair, make the field setting in accordance with the following description. Wrong setting may cause error. (When optional accessory is mounted on the indoor unit, setting for the indoor unit may be required to change.)

### 1.1.1 BRC1E73

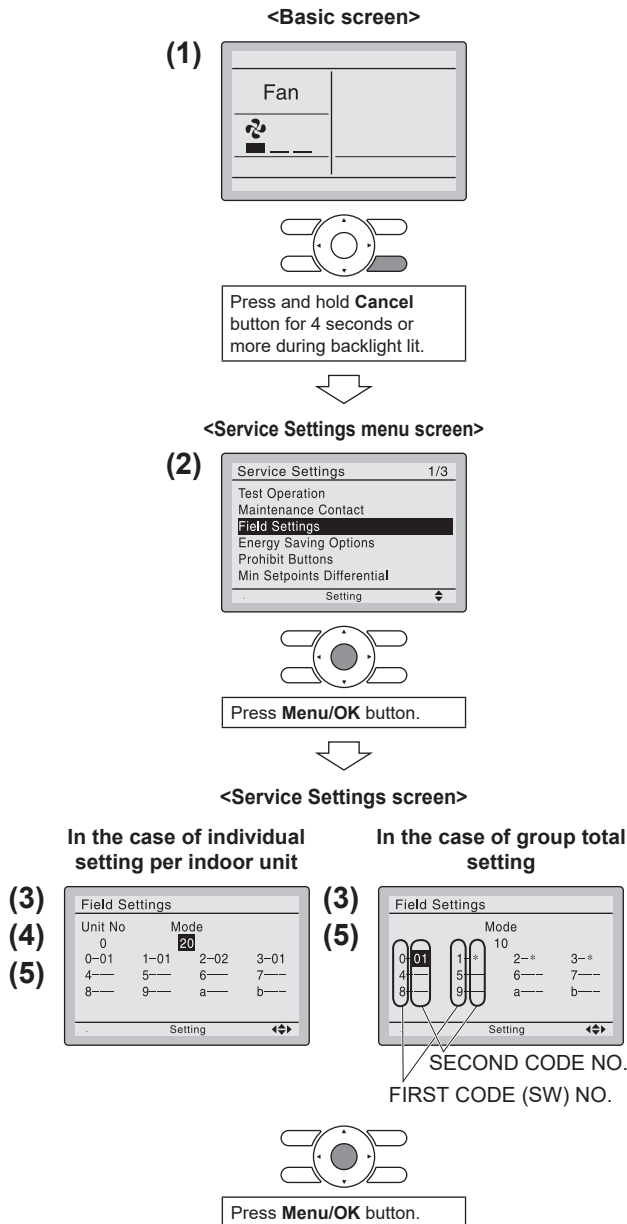

1. Press and hold **Cancel** button for 4 seconds or more. Service settings menu is displayed.
2. Select **Field Settings** in the Service Settings menu, and press **Menu/OK** button. Field settings screen is displayed.
3. Highlight the mode, and select desired **Mode No.** by using **▲▼** (Up/Down) button.
4. In the case of setting per indoor unit during group control (When Mode No. such as **20, 21, 22, 23, 25** are selected), highlight the unit No. and select **Indoor unit No.** to be set by using **▲▼** (Up/Down) button. (In the case of group total setting, this operation is not needed.)

In the case of individual setting per indoor unit, current settings are displayed. And, SECOND CODE NO. “ - ” means no function.

5. Highlight SECOND CODE NO. of the FIRST CODE NO. to be changed, and select desired **SECOND CODE NO.** by using **▲▼** (Up/Down) button. Multiple identical mode number settings are available.

In case of setting for all indoor units in the remote control group, available SECOND CODE NO. is displayed as “ \* ” which means it can be changed. When SECOND CODE NO. is displayed as “ - ”, there is no function.



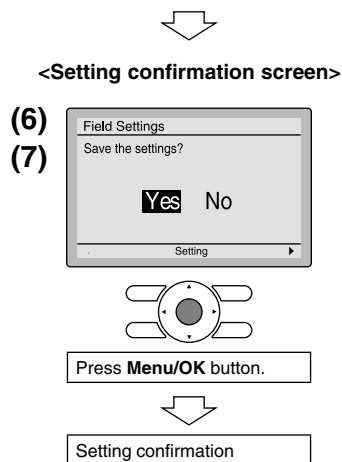

6. Press **Menu/OK** button. Setting confirmation screen is displayed.
7. Select **Yes** and press **Menu/OK** button. Setting details are determined and field settings screen returns.
8. In the case of multiple setting changes, repeat (3) to (7).
9. After all setting changes are completed, press **Cancel** button twice.
10. Backlight goes out, and **Checking the connection. Please standby.** is displayed for initialization. After the initialization, the basic screen returns.

#### NOTE

- Installation of optional accessories on the indoor unit may require changes to field settings. See the manual of the optional accessory.
- For field setting details related to the indoor unit, see installation manual shipped with the indoor unit.

### 1.1.2 BRC1H71W

Enter the Installer Menu and make settings.

Installer menu screen

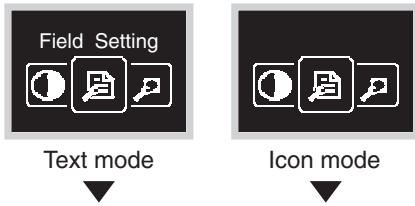

Press **←** or **→** button, for move to “”.  
 If Bluetooth is connected, performing field setting from the remote controller side is impossible.  
 Disconnect Bluetooth, or perform field setting from the mobile application.

Sub-menu screen

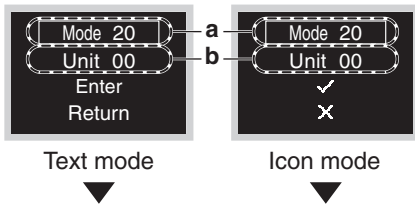

Press **+** or **-** button, to select Mode No. and press **○** to enter the field setting menu.  
**a** Mode No.  
**b** Unit No.

Sub-menu screen

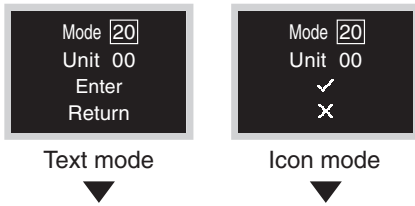

Press **←** or **→** button, to scroll the desired Mode No. and press **○** button.

Sub-menu screen

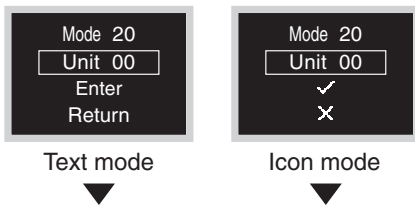

Press **←** or **→** button, to select Unit No. and press **○** button.

## Sub-menu screen

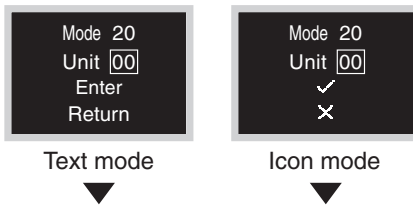

Press **-** or **+** button, scroll to the desired Unit No. and then press **OK** button to set the selection.

## Sub-menu screen

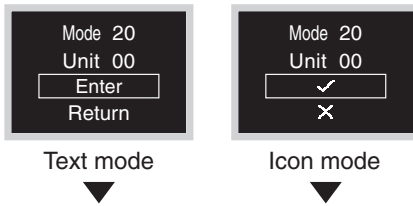

Press **-** or **+** button, to select "Enter" or "**✓**", and then press **OK** button to set the selection.

## Sub-menu screen

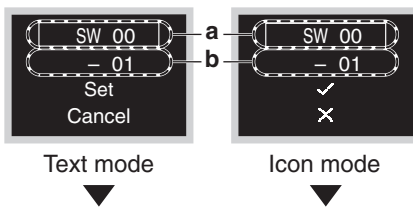

Press **-** or **+** button, select First Code No., and then press **OK** button.

- a First Code No.
- b Second Code No.

## Sub-menu screen

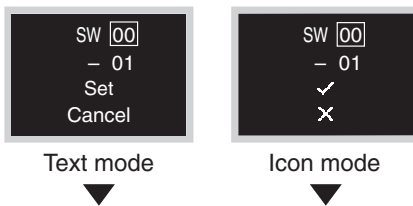

Press **+** or **-** button, scroll to the desired First code No. and then press **OK** button to set the selection.

## Sub-menu screen

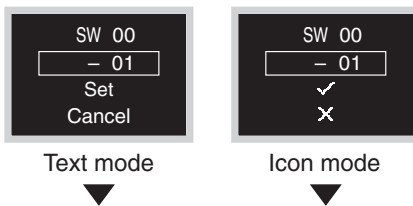

Press **-** or **+** button, to move Second Code No., and then press **OK** button.

---

Sub-menu screen

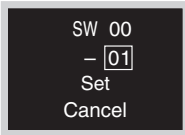

Text mode



Icon mode

Press **-** or **+** button, to scroll to the desired Second Code No., and then press **OK** button.

---

Sub-menu screen



Text mode



Icon mode

Press **-** or **+** button, select “Set” or “**✓**”, and then press **OK** button to save the setting and return to the previous screen.

If the setting is not changed, select “Cancel” or “**X**”.

---

Sub-menu screen

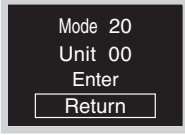

Text mode

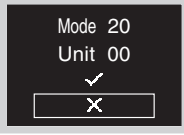

Icon mode

Press **-** or **+** button, move to “Return” or “**X**”, and then press **OK** button to return to the installer menu.

\* If the setting has been changed, the screen may return to the home screen without returning to the installer menu.

---

### CAUTION

- The connection of optional accessories to the indoor unit might cause changes to some field settings. For more information, see the installation manual of the optional accessory.
  - For details about the specific field settings of each type of indoor unit, see the installation manual of the indoor unit.
  - Field settings that are not available for a connected indoor unit are not displayed.
  - Field setting default values are different depending on the indoor unit model.
- 

### NOTICE

- Installation of optional accessories on the indoor unit may require changes to field settings. See the manual of the optional accessory.
  - For field setting details related to the indoor unit, see installation manual shipped with the indoor unit.
-

### 1.1.3 Wireless Remote Controller

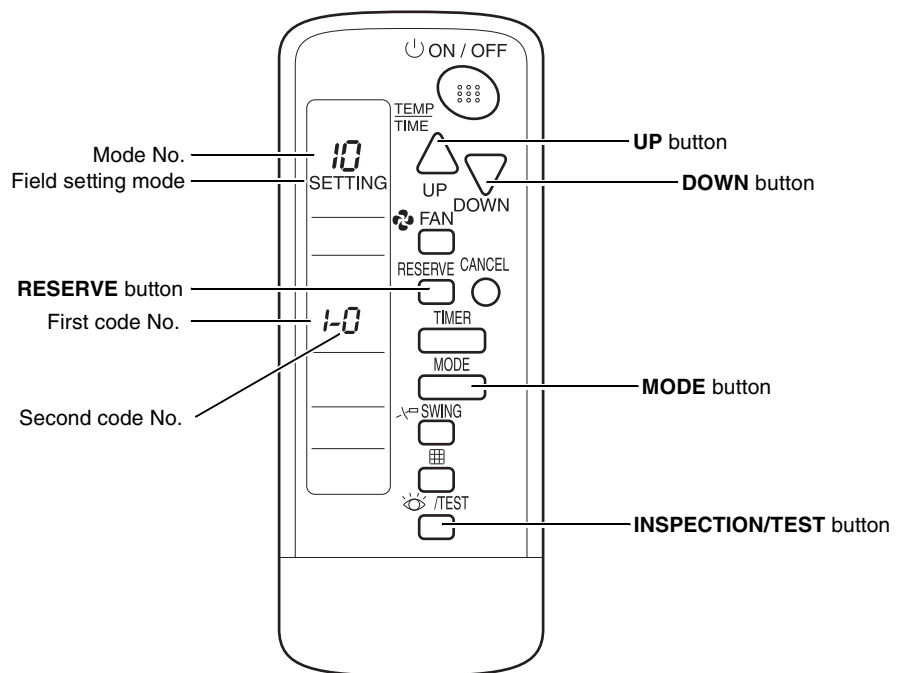

To set the field settings, you have to change:

- Mode No.
- First code No.
- Second code No.

To change the field settings, proceed as follows:

1. Press the **INSPECTION/TEST** button for 4 seconds during normal mode to enter the field setting mode.
2. Press the **MODE** button to select the desired mode No.
3. Press the **UP** button to select the first code No.
4. Press the **DOWN** button to select the second code No.
5. Press the **RESERVE** button to confirm the setting.
6. Press the **INSPECTION/TEST** button to return to the normal mode.

## 1.2 List of Field Settings for Indoor Unit

★: Factory setting

Mode No. (Note 2)	First Code No.	Setting Contents		Second Code No.				Reference Page		
				01	02	03	04			
10 (20)	0	Filter cleaning sign interval	Ultra long life filter	<b>Light★</b>	<b>Approx. 10,000 hrs.★</b>	<b>Heavy</b>	Approx. 5,000 hrs.	—	—	217
			Long life filter		<b>Approx. 2,500 hrs.★</b>		Approx. 1,250 hrs.			
		Standard filter	<b>Approx. 200 hrs.★</b>		Approx. 100 hrs.					
	0	Filter sign setting		<b>Light★</b>	Heavy		—	—	217	
	1	Filter type		<b>Long life filter★</b>	Ultra long life filter		—	—	217	
	1	Filter cleaning sign interval		<b>Short interval★</b>	Long interval		—	—	217	
	2	Remote controller thermistor		Refer to page on the right for details.				217		
	3	Filter cleaning sign		<b>Displayed★</b>	Not displayed		—	—	219	
	5	Information for intelligent Touch Manager / intelligent Touch Controller		Refer to page on the right for details.				219		
6	Remote controller thermistor control during group control		<b>Not permitted★</b>	Permitted		—	—	218		
7	Time for absence area detection		<b>30 minutes★</b>	60 minutes		—	—	219		
11 (21)	1	Auxiliary electric heater ON temperature: Ton		Refer to page on the right for details.				220		
	1	Auxiliary electric heater ON/OFF temperature: Ton/Toff								
	2	Auxiliary electric heater OFF temperature: Toff								
	3	Setting of airflow rate when heating		<b>Standard★</b>	Slightly increased	Increased	—	221		
	3	Electric heater setting		Refer to page on the right for details.				222		
	5	Electric heater capacity setting		Refer to page on the right for details.				222		
	6	Detection rate setting		High sensitivity	Low sensitivity	<b>Standard sensitivity★</b>	Infrared presence sensor disabled	223		
	7	Automatic airflow adjustment		<b>OFF★</b>	Completion of airflow adjustment	Start of airflow adjustment	—	223		
	8	Compensating the temperature around people		Suction air temperature only	Priorities given on the suction air temperature	<b>Standard★</b>	Priorities given on the floor temperature	224		
	9	Compensating the floor temperature when heating		-4°C (-7.2°F)	-2°C (-3.6°F)	<b>0°C (0°F)★</b>	+2°C (+3.6°F)	224		
12	Dry mode set temperature		<b>Room temperature★</b>	Same as cooling mode set temperature		—	—	224		
12 (22)	0	Optional accessories output selection		Refer to page on the right for details.				225		
	1	External ON/OFF input		Refer to page on the right for details.				225		
	2	Thermostat differential changeover		1°C (1.8°F)	0.5°C (0.9°F)	—	—	225		
	3	Airflow setting when heating thermostat is OFF		<b>LL tap★</b>	Set fan speed	OFF	—	226		
	4	Automatic mode differential		Refer to page on the right for details.				226		
	5	Auto restart after power failure		OFF	<b>ON★</b>	—	—	226		
	6	Airflow setting when cooling thermostat is OFF		LL tap	<b>Set fan speed★</b>	OFF	—	227		

Mode No. (Note 2)	First Code No.	Setting Contents	Second Code No.				Reference Page
			01	02	03	04	
13 (23)	0	Ceiling height setting, Setting of normal airflow	<b>Standard★</b>	High ceiling 1	High ceiling 2	—	227
	1	Airflow direction setting	<b>4-direction airflow★</b>	3-direction airflow	2-direction airflow	—	228
	2	Swing pattern settings	All direction synchronized swing	—	<b>Facing swing★</b>	—	229
	4	Airflow direction adjustment range	Draft prevention	<b>Standard★</b>	Ceiling soiling prevention	—	229
	5	Setting of static pressure selection	Refer to page on the right for details.				229
	6	External static pressure settings	Refer to page on the right for details.				230
14 (24)	4	Optional kit setting (UV lamp + humidifier + economizer)	Refer to page on the right for details.				232
	5	Dry mode set temperature	<b>Room temperature★</b>	Same as cooling mode set temperature	—	—	232
	9	Mold proof operation setting	—	<b>Standard★</b>	For high humidity areas	—	232
	11	Gas furnace test mode	<b>OFF★</b>	Low heat	High heat	—	232
15 (25)	0	Drain pump operation setting	Refer to page on the right for details.				233
	1	Humidification when heating thermostat is OFF	<b>Not equipped★</b>	Equipped	—	—	233
	2	Direct duct connection	<b>Not equipped★</b>	Equipped	—	—	233
	3	Drain pump and humidifier interlock selection	<b>Not interlocked★</b>	Interlocked	—	—	233
	5	Individual ventilation setting	<b>Normal★</b>	Individual	—	—	234
1b	4	Display of error codes on the remote controller	—	Two-digit display	—	<b>Four-digit display★</b>	234
1c	0	Room temperature display	Not displayed	<b>Displayed★</b>	—	—	234
	1	Thermistor sensor for auto changeover and setback control by the remote controller	Utilize the return air thermistor	<b>Utilize the remote controller thermistor★</b>	—	—	234
	3	Access permission level setting	<b>Level 2★</b>	Level 3	—	—	235
1e	2	Setback availability	<b>N/A★</b>	Heat only	Cool only	Cool/heat	235
	14	Setting restricted/permitted of airflow block	Refer to page on the right for details.				235

**Note(s)**

- Settings are made simultaneously for the entire group, however, if you select the mode No. inside parentheses, you can also set by each individual unit. Setting changes however cannot be checked except in the individual mode for those in parentheses.
- The mode numbers inside parentheses cannot be used by wireless remote controllers, so they cannot be set individually. Setting changes also cannot be checked.
- Do not make settings other than those described above. Nothing is displayed for functions the indoor unit is not equipped with.
- 88 or Checking the connection. Please stand by.** may be displayed to indicate the remote controller is resetting when returning to the normal mode.

### 1.3 Applicable Field Settings

Field setting	First Code No.	Setting Modes	FXEQ-AA	FXFQ-T	FXZQ-TA FXZQ-TB	FXUQ-P FXUQ-PA	FXEQ-P	FXDQ-M	FXSQ-TA FXSQ-TB	FXMQ-PB	FXMQ-TB
10 (20)	0	Filter cleaning sign interval	●	●	●	●	●	●	●	●	●
	0	Filter sign setting	—	—	—	—	—	—	—	—	—
	1	Filter type	●	●	●	●	—	—	●	—	●
	1	Filter cleaning sign interval	—	—	—	—	—	—	—	—	—
	2	Remote controller thermistor	●	●	●	●	●	●	●	●	●
	3	Filter cleaning sign	●	●	●	●	●	●	●	●	●
	5	Information for intelligent Touch Manager/ intelligent Touch Controller	●	●	●	●	●	●	●	●	●
	6	Remote controller thermistor control during group control	●	●	●	●	●	●	●	●	●
	7	Time for absence area detection	●	●	●	●	—	—	—	—	—
11 (21)	1	Auxiliary electric heater ON temperature	●	—	●	●	●	—	●	—	●
	1	Auxiliary electric heater ON/OFF temperature	—	●	—	—	—	—	—	●	—
	2	Auxiliary electric heater OFF temperature	●	—	●	●	●	—	●	—	●
	3	Setting of airflow rate when heating	●	●	●	●	●	—	—	—	—
	3	Electric heater setting	—	—	—	—	—	—	—	—	—
	5	Electric heater capacity setting	—	—	—	—	—	—	—	—	—
	6	Detection rate setting	●	●	●	●	—	—	—	—	—
	7	Automatic airflow adjustment	—	—	—	—	—	—	●	● (*1)	●
	8	Compensating the temperature around people	●	●	●	●	—	—	—	—	—
	9	Compensating the floor temperature when heating	●	●	●	●	—	—	—	—	—
12	Dry mode set temperature	●	—	TA: — TB: ●	P: — PA: ●	—	—	TA: — TB: ●	—	●	
12 (22)	0	Optional accessories output selection	●	●	●	●	●	●	●	●	●
	1	External ON/OFF input	●	●	●	●	●	●	●	●	●
	2	Thermostat differential changeover	●	●	●	●	●	●	●	●	●
	3	Airflow setting when heating thermostat is OFF	●	●	●	●	●	●	●	●	●
	4	Automatic mode differential	●	●	●	●	●	●	●	●	●
	5	Auto restart after power failure	●	●	●	●	●	●	●	●	●
	6	Airflow setting when cooling thermostat is OFF	●	●	●	●	●	●	●	●	●



Note(s)

\*1. FXMQ07-48PBVJU only



Field setting	First Code No.	Setting Modes	FXFQ-AA	FXFQ-T	FXZQ-TA FXZQ-TB	FXUQ-P FXUQ-PA	FXEQ-P	FXDQ-M	FXSQ-TA FXSQ-TB	FXMQ-PB	FXMQ-TB
13 (23)	0	Ceiling height setting, Setting of normal airflow	●	●	●	●	●	—	—	—	—
	1	Airflow direction setting	●	●	●	●	—	—	—	—	—
	2	Swing pattern settings	●	●	●	●	—	—	—	—	—
	4	Airflow direction adjustment range	●	●	●	●	●	—	—	—	—
	5	Setting of static pressure selection	—	—	—	—	—	●	—	—	—
	6	External static pressure settings	—	—	—	—	—	—	●	●	●
14 (24)	4	Optional kit setting (UV lamp + Humidifier + Economizer)	—	—	—	—	—	—	—	—	—
	5	Dry mode set temperature	—	—	—	—	—	—	—	—	—
	9	Mold proof operation setting	—	—	—	—	●	—	—	—	—
	11	Gas furnace test mode	—	—	—	—	—	—	—	—	—
15 (25)	0	Drain pump operation settings	—	—	—	—	—	—	—	●	—
	1	Humidification when heating thermostat is OFF	●	●	●	●	●	●	●	●	●
	2	Direct duct connection	●	●	●	●	●	—	—	—	—
	3	Drain pump and humidifier interlock selection	●	●	●	●	●	●	●	●	●
	5	Individual ventilation setting	●	●	●	●	●	●	●	●	●
1b	4	Display of error codes on the remote controller	●	●	●	●	●	●	●	●	●
1c	0	Room temperature display	●	●	●	●	●	●	●	●	●
	1	Thermistor sensor for auto changeover and setback control by the remote controller	●	●	●	●	●	●	●	●	●
	3	Access permission level setting	●	●	●	●	●	●	●	●	●
1e	2	Setback availability	●	●	●	●	●	●	●	●	●
	14	Setting restricted/permitted of airflow block	●	●	—	—	—	—	—	—	—

● : Available  
 — : Not available

Field setting	First Code No.	Setting Modes	FXMQ-TA	FXMQ-M	FXHQ-M	FXAQ-P	FXLQ-M	FXNQ-M	FXTQ-TA FXTQ-TB	CXTQ-TA
10 (20)	0	Filter cleaning sign interval	●	●	●	●	●	●	—	—
	0	Filter sign setting	—	—	—	—	—	—	●	●
	1	Filter type	●	●	—	—	—	—	—	—
	1	Filter cleaning sign interval	—	—	—	—	—	—	●	●
	2	Remote controller thermistor	●	●	●	●	●	●	●	●
	3	Filter cleaning sign	●	●	●	●	●	●	●	●
	5	Information for intelligent Touch Manager/ intelligent Touch Controller	●	●	●	●	●	●	●	●
	6	Remote controller thermistor control during group control	●	●	●	●	●	●	●	●
11 (21)	1	Auxiliary electric heater ON temperature	●	—	—	—	●	●	●	●
	1	Auxiliary electric heater ON/OFF temperature	—	—	—	—	—	—	—	—
	2	Auxiliary electric heater OFF temperature	●	—	—	—	●	●	●	●
	3	Setting of airflow rate when heating	—	—	—	—	—	—	—	—
	3	Electric heater setting	—	—	—	—	—	—	●	—
	5	Electric heater capacity setting	—	—	—	—	—	—	●	—
	6	Detection rate setting	—	—	—	—	—	—	—	—
	7	Automatic airflow adjustment	●	—	—	—	—	—	—	—
	8	Compensating the temperature around people	—	—	—	—	—	—	—	—
	9	Compensating the floor temperature when heating	—	—	—	—	—	—	—	—
	12	Dry mode set temperature	●	—	—	—	—	—	—	—
12 (22)	0	Optional accessories output selection	●	●	●	●	●	●	●	●
	1	External ON/OFF input	●	●	●	●	●	●	●	●
	2	Thermostat differential changeover	●	●	●	●	●	●	●	●
	3	Airflow setting when heating thermostat is OFF	●	●	●	●	●	●	●	●
	4	Automatic mode differential	●	●	●	●	●	●	●	●
	5	Auto restart after power failure	●	●	●	●	●	●	●	●
	6	Airflow setting when cooling thermostat is OFF	●	●	●	●	●	●	●	●
13 (23)	0	Ceiling height setting, Setting of normal airflow	●	—	●	●	—	—	—	—
	1	Airflow direction setting	—	—	—	—	—	—	—	—
	2	Swing pattern settings	—	—	—	—	—	—	—	—
	4	Airflow direction adjustment range	—	—	—	●	—	—	—	—
	5	Setting of static pressure selection	●	—	—	—	—	—	—	—
	6	External static pressure settings	●	—	—	—	—	—	—	—

Field setting	First Code No.	Setting Modes	FXMQ-TA	FXMQ-M	FXHQ-M	FXAQ-P	FXLQ-M	FXNQ-M	FXTQ-TA FXTQ-TB	CXTQ-TA
14 (24)	4	Optional kit setting (UV lamp + Humidifier + Economizer)	—	—	—	—	—	—	●	●
	5	Dry mode set temperature	—	—	—	—	—	—	●	●
	9	Mold proof operation setting	—	—	—	—	—	—	—	—
	11	Gas furnace test mode	—	—	—	—	—	—	—	●
15 (25)	0	Drain pump operation settings	●	—	—	—	—	—	—	—
	1	Humidification when heating thermostat is OFF	●	●	●	●	●	●	●	●
	2	Direct duct connection	—	—	—	●	—	—	—	—
	3	Drain pump and humidifier interlock selection	●	●	●	●	●	●	—	—
	5	Individual ventilation setting	●	●	●	●	●	●	●	●
1b	4	Display of error codes on the remote controller	●	●	●	●	●	●	●	●
1c	0	Room temperature display	●	●	●	●	●	●	●	●
	1	Thermistor sensor for auto changeover and setback control by the remote controller	●	●	●	●	●	●	●	●
	3	Access permission level setting	—	●	●	●	●	●	●	●
1e	2	Setback availability	●	●	●	●	●	●	●	●
	14	Setting restricted/permitted of airflow block	—	—	—	—	—	—	—	—

● : Available  
 — : Not available

# 1.4 Details of Field Settings for Indoor Unit

## 1.4.1 Filter Cleaning Sign Interval, Filter Type

★: Factory setting

Setting	10 (20)-1	<b>01: Long life filter★</b>		02: Ultra long life filter	
	Filter contamination heavy/light 10 (20)-0	<b>Light 01★</b>	Heavy 02	Light 01	Heavy 02
Model	FXFQ-AA	<b>2,500 hrs.★</b>	1,250 hrs.	10,000 hrs.	5,000 hrs.
	FXFQ-T				
	FXZQ-TA				
	FXZQ-TB				
	FXUQ-P				
	FXUQ-PA				
	FXEQ-P				
	FXSQ-TA				
	FXSQ-TB				
	FXMQ-PB				
	FXMQ-TB				
	FXMQ-TA				
	FXMQ-M				
	FXHQ-M				
	FXLQ-M				
	FXNQ-M				
	FXDQ-M	<b>200 hrs.★</b>	100 hrs.	200 hrs.	100 hrs.
	FXAQ-P				

Setting	10 (20)-1	<b>01: Short interval★</b>		02: Long interval	
	Filter contamination heavy/light 10 (20)-0	<b>Light 01★</b>	Heavy 02	Light 01	Heavy 02
Model	FXTQ-TA	<b>2,500 hrs. ★</b>	1,250 hrs.	10,000 hrs.	5,000 hrs.
	FXTQ-TB				
	CXTQ-TA				

## 1.4.2 Remote Controller Thermistor

Select a thermistor to control the room temperature.

**When the unit is not equipped with an infrared floor sensor:**

★: Factory setting

Mode No.	First Code No.	Second Code No.	Contents
10 (20)	2	<b>01★</b>	<b>Remote controller thermistor and suction air thermistor★</b>
		02	Suction air thermistor only
		03	Remote controller thermistor only

The factory setting for the Second Code No. is **01** and room temperature is controlled by the suction air thermistor and remote controller thermistor. When the Second Code No. is set to **02**, room temperature is controlled by the suction air thermistor. When the Second Code No. is set to **03**, room temperature is controlled by the remote controller thermistor.



**Note(s)**

For FXFQ-AA, the factory setting for the Second Code No. is **02**.

■ FXTQ-TA, FXTQ-TB, CXTQ-TA

★: Factory setting

Mode No.	First Code No.	Second Code No.	Contents
10 (20)	2	01	—
		02	Remote sensor thermistor only
		<b>03★</b>	<b>Remote controller thermistor only★</b>

When the Second Code No. is set to **02**, room temperature is controlled by the remote sensor thermistor. When the Second Code No. is set to **03**, room temperature is controlled by the remote controller thermistor.

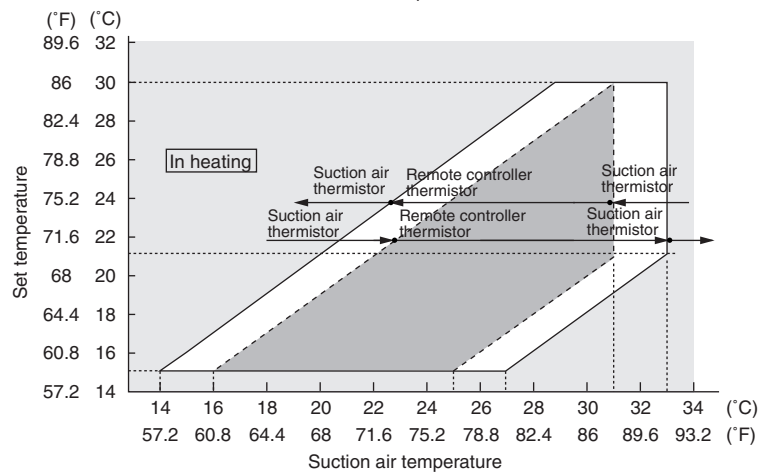
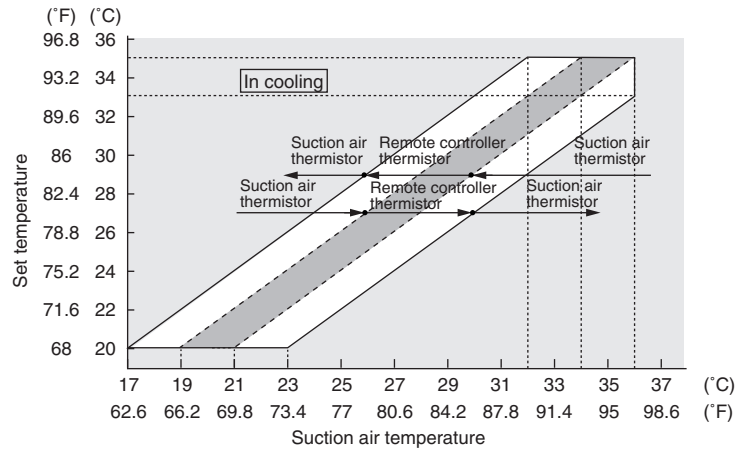

When the unit is equipped with an infrared floor sensor:

★: Factory setting

Mode No.	First Code No.	Second Code No.					
10 (20)	2	01	02	02	<b>02★</b>	02	03
11 (21)	8	01	01	02	<b>03★</b>	04	01

The thermistor to be used

Remote controller thermistor	●	—	—	—	—	—	●
Suction air thermistor	●	●	●	●	●	●	—
Infrared floor sensor	—	—	●	●	●	●	—

The infrared floor sensor is not used

Priority given to the suction air temperature (\*)

Priority given to the floor temperature (\*)

Only the suction air thermistor is used

Standard setting (Factory setting)

Only the remote controller thermistor is used

\*Refer to **Compensating the Temperature around People** on page 224.

**Note(s)**

The control is automatically switched to the one performed only by the suction air thermistor for indoor unit when the Second code No. is **01** during group control.

To use the **remote controller thermistor control during group control**, select the Second code No. **02** in First code No. **6**.

★: Factory setting

Mode No.	First Code No.	Second Code No.	Contents
10 (20)	6	<b>01</b> ★	<b>Remote controller thermistor control is not permitted during group control</b> ★
		02	Remote controller thermistor control is permitted during group control.

**Note(s)**

When the 10 (20)-6 setting is changed to **02**, several indoor units are controlled by one remote controller thermistor, so note that the room temperature might be uneven.

### 1.4.3 Filter Cleaning Sign

Whether or not to display the sign after operation of a certain duration can be selected.

★: Factory setting

Mode No.	First Code No.	Second Code No.	Contents
10 (20)	3	<b>01</b> ★	<b>Displayed</b> ★
		02	Not displayed

\* Filter cleaning sign is not displayed when a self-cleaning decoration panel is mounted.

### 1.4.4 Information for intelligent Touch Manager/intelligent Touch Controller

★: Factory setting

Mode No.	First Code No.	Second Code No.	Contents
10 (20)	5	<b>01</b> ★	<b>Only indoor unit sensor value (or remote controller sensor value, if installed.)</b> ★
		02	Sensor values according to 10 (20)-2 and 10 (20)-6.

\* When field setting 10 (20)-6-**02** is set at the same time as 10 (20)-2-**01,02,03**, field setting 10 (20)-2 has priority.

When field setting 10 (20)-6-**01** is set at the same time as 10 (20)-2-**01,02,03**, field setting 10 (20)-6 has priority for group connection, and 10 (20)-2 has priority for individual connection.

### 1.4.5 Time for Absence Area Detection (For units with an infrared presence sensor only)

By selecting the energy-saving operation mode in the absence, the target temperature is shifted to the energy-saving end by 1°C (1.8°F) (maximum 2°C (3.6°F)) after the state of absence continues for a certain period of time. Absent time defined for detection can be selected as follows:

★: Factory setting

Mode No.	First Code No.	Second Code No.	Contents
10 (20)	7	<b>01</b> ★	<b>30 minutes</b> ★
		02	60 minutes

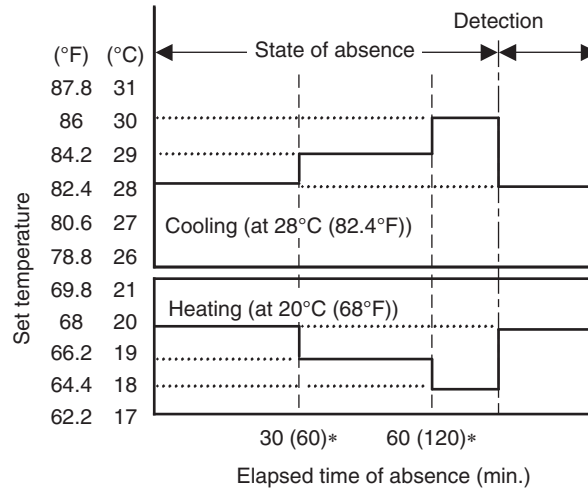

- The set temperature displayed on the remote controller remains the same even if the target temperature is shifted.
- As soon as people are detected while the temperature is shifted, this control will be cancelled (reset).

### 1.4.6 Auxiliary Electric Heater ON/OFF Temperature

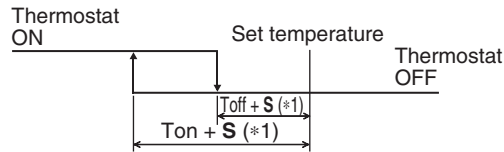

**Note(s)**

\*1. **S** value varies automatically based on the room temperature trend.

■ **FXFQ-T, FXMQ-PB**

★: Factory setting

Mode No.	First Code No.	Symbol	Second Code No.					
			01★	02	03	04	05	06
11 (21)	1	Ton	$\frac{-4^{\circ}\text{C}}{(-7.2^{\circ}\text{F})}$ ★	-3.5°C (-6.3°F)	-3°C (-5.4°F)	-2.5°C (-4.5°F)	-2°C (-3.6°F)	-1.5°C (-2.7°F)
		Toff	$\frac{-2^{\circ}\text{C}}{(-3.6^{\circ}\text{F})}$ ★	-1.5°C (-2.7°F)	-1°C (-1.8°F)	-0.5°C (-0.9°F)	0°C (0°F)	0.5°C (0.9°F)

■ **FXFQ-AA, FXZQ-TA, FXZQ-TB, FXUQ-P, FXUQ-PA, FXEQ-P, FXSQ-TA, FXSQ-TB, FXMQ-TB, FXMQ-TA, FXLQ-M, FXNQ-M, FXTQ-TA, FXTQ-TB**

★: Factory setting

Mode No.	First Code No.	Symbol	Second Code No.					
			01★	02	03	04	05	06
11 (21)	1	Ton	$\frac{-4^{\circ}\text{C}}{(-7.2^{\circ}\text{F})}$ ★	-3.5°C (-6.3°F)	-3°C (-5.4°F)	-2.5°C (-4.5°F)	-2°C (-3.6°F)	-1.5°C (-2.7°F)
	2	Toff	$\frac{-2^{\circ}\text{C}}{(-3.6^{\circ}\text{F})}$ ★	-1.5°C (-2.7°F)	-1°C (-1.8°F)	-0.5°C (-0.9°F)	0°C (0°F)	0.5°C (0.9°F)

There is a limitation of combination between Ton and Toff as below due to 2°C (3.6°F) hysteresis required for reliability.

Second Code No.			Ton					
			01	02	03	04	05	06
			-4°C (-7.2°F)	-3.5°C (-6.3°F)	-3°C (-5.4°F)	-2.5°C (-4.5°F)	-2°C (-3.6°F)	-1.5°C (-2.7°F)
Toff	06	0.5°C (0.9°F)	●	●	●	●	●	●
	05	0°C (0°F)	●	●	●	●	●	—
	04	-0.5°C (-0.9°F)	●	●	●	●	—	—
	03	-1°C (-1.8°F)	●	●	●	—	—	—
	02	-1.5°C (-2.7°F)	●	●	—	—	—	—
01	-2°C (-3.6°F)	●	—	—	—	—	—	

● : Available  
 — : Not available

■ CXTQ-TA

★: Factory setting

Mode No.	First Code No.	Symbol	Second Code No.						
			01	02	03	04	05	06	07 (*1)
11 (21)	1	Ton	<del>-4°C</del> <del>(-7.2°F)</del> ★	-3.5°C (-6.3°F)	-3°C (-5.4°F)	-2.5°C (-4.5°F)	-2°C (-3.6°F)	-1.5°C (-2.7°F)	-100°C (-148°F)
	2	Toff	-2°C (-3.6°F)	-1.5°C (-2.7°F)	-1°C (-1.8°F)	-0.5°C (-0.9°F)	<del>0°C</del> <del>(0°F)</del> ★	0.5°C (0.9°F)	-98°C (-144.4°F)

\*1 The second code No. 07 is used for disabling the starting of gas furnace interlocking with room temperature.

Second Code No.			Ton						
			01	02	03	04	05	06	07
			-4°C (-7.2°F)	-3.5°C (-6.3°F)	-3°C (-5.4°F)	-2.5°C (-4.5°F)	-2°C (-3.6°F)	-1.5°C (-2.7°F)	-100°C (-148°F)
Toff	07	-98°C (-144.4°F)	—	—	—	—	—	—	●
	06	0.5°C (0.9°F)	●	●	●	●	●	●	●
	05	0°C (0°F)	●	●	●	●	●	—	●
	04	-0.5°C (-0.9°F)	●	●	●	●	—	—	●
	03	-1°C (-1.8°F)	●	●	●	—	—	—	●
	02	-1.5°C (-2.7°F)	●	●	—	—	—	—	●
01	-2°C (-3.6°F)	●	—	—	—	—	—	●	

● : Available  
 — : Not available

### 1.4.7 Setting of Airflow Rate when Heating

The fan revolution is changed to maintain the sufficient distance for warm air to reach during the heating operation. The setting should be changed depending on the installation condition of the unit.

★: Factory setting

Mode No.	First Code No.	Second Code No.	Contents
11 (21)	3	<b>01★</b>	<b>Standard★</b>
		02	Slightly increased
		03	Increased

Note that this setting is effective only during the heating operation.



### 1.4.8 Electric Heater Setting (for FXTQ-TA, FXTQ-TB models)

★: Factory setting

Mode No.	First Code No.	Second Code No.	Contents	
			Heater operation	Electric heater run for defrost/oil return operation
11 (21)	3	<b>01★</b>	<b>Electric heater with heat pump not allowed★</b>	<b>Not allowed★</b>
		02	Electric heater with heat pump allowed	Not allowed
		07	Electric heater with heat pump not allowed	Allowed
		08	Electric heater with heat pump allowed	Allowed

### 1.4.9 Electric Heater Capacity Setting (for FXTQ-TA, FXTQ-TB models)

★: Factory setting

Model	Mode No.	First Code No.	Second Code No.										
			<b>01★</b>	02	03	04	05	06	07	08	09	10	
			Heater (kW)										
			<b>No heater kit★</b>	3	5	6	8	10	15	19	20	25	
FXTQ09TA FXTQ09TB	11 (21)	5	●★	●	●	—	—	—	—	—	—	—	
FXTQ12TA FXTQ12TB			●★	●	●	●	—	—	—	—	—	—	—
FXTQ18TA FXTQ18TB			●★	●	●	●	●	●	—	—	—	—	—
FXTQ24TA FXTQ24TB			●★	●	●	●	●	●	—	—	—	—	—
FXTQ30TA FXTQ30TB			●★	●	●	●	●	●	—	—	—	—	—
FXTQ36TA FXTQ36TB			●★	●	●	●	●	●	—	—	—	—	—
FXTQ42TA FXTQ42TB			●★	—	●	●	●	●	●	●	●	—	—
FXTQ48TA FXTQ48TB			●★	—	●	●	●	●	●	●	●	—	—
FXTQ54TA FXTQ54TB			●★	—	●	●	●	●	●	●	—	●	●
FXTQ60TA FXTQ60TB			●★	—	●	●	●	●	●	●	—	●	●

● : Available

— : Not available

### 1.4.10 Detection Rate Setting (For units with an infrared presence sensor only)

Set the sensitivity of the infrared presence sensor.

- The infrared presence sensor can be disabled by selecting the Second code No. **04**.



#### Note(s)

When the infrared presence sensor is disabled, the remote controller menu does not display some functions such as the automatic draft reduction, energy-saving operation in absence and halt in absence.

★: Factory setting

Mode No.	First Code No.	Second Code No.	Contents
11 (21)	6	01	High sensitivity
		02	Low sensitivity
		<b>03★</b>	<b>Standard sensitivity★</b>
		04	Infrared presence sensor disabled

### 1.4.11 Automatic Airflow Adjustment

Make external static pressure setting automatically using automatic airflow adjustment (11 (21)-7), or manually using external static pressure settings (13 (23)-6).

The volume of blow-off air is automatically adjusted to the rated quantity.

Make settings before performing the test operation of the outdoor unit.

#### Setting procedure

1. Make sure that electric wiring and duct construction have been completed. In particular, if the closing damper is installed on the way of the duct, make sure that it is open. In addition, make sure that a field-supplied air filter is installed within the air passageway on the suction port side.
2. If there are multiple blow-off and suction ports, adjust the throttle part so that the airflow volume ratio of each suction/blow-off port conforms to the designed airflow volume ratio. In that case, operate the unit with fan operation mode. When you want to change the airflow rate, adjust it by pressing the airflow rate control button to select High, Middle or Low.
3. Make settings to adjust the airflow rate automatically. After setting to fan operation mode, enter the field setting mode while operation is stopped and then select the Mode No. 11 (21), set the First Code No. to **7** and the Second Code No. to **03**.
4. After setting, return to the basic screen (to the normal mode in the case of a wireless remote controller) and press the ON/OFF button. Fan operation for automatic airflow adjustment will start with the operation lamp turned ON. Do not adjust the throttle part of the suction and blow-off ports during automatic adjustment. After operation for approximately one to fifteen minutes, airflow adjustment automatically stops with the operation lamp turned OFF.
5. After operation stopped, make sure that the Second Code No. is set to **02** as in the following table by indoor unit with the Mode No. 11 (21). If operation does not stop automatically or the Second Code No. is not set to **02**, return to the step 3 above to make settings again.

★: Factory setting

Mode No.	First Code No.	Second Code No.	Contents
11 (21)	7	<b>01★</b>	<b>OFF★</b>
		02	Completion of airflow adjustment
		03	Start of airflow adjustment



#### Note(s)

1. Make sure that the external static pressure is within the range of specifications before making settings. If it is outside the range, automatic adjustment fails, which may cause an insufficient airflow volume or leakage of water.
2. If the air passageway including duct or blow-off ports is changed after automatic adjustment, make sure to perform automatic airflow adjustment again.

### 1.4.12 Compensating the Temperature around People (For units with the infrared floor sensor only)

Change the ratio between the suction air temperature and floor temperature used to calculate the temperature around human.

The temperature around human is calculated using the values of the suction air thermistor and the infrared floor sensor. The factory setting is Normal (the average value of the suction air temperature and the floor temperature is applied). However, the rate at which the suction air thermistor and the infrared floor sensor affect the temperature around human can be changed with this setting.

- To reflect the effect of the temperature around the ceiling, select **02** for the second code.
- To reflect the effect of the temperature around the floor, select **04** for the second code.
- The infrared floor sensor can be disabled by selecting **01** for the second code.

★: Factory setting

Mode No.	First Code No.	Second Code No.	Contents
11 (21)	8	01	Suction air temperature only
		02	Priority given on the suction air temperature
		<b>03★</b>	<b>Standard★</b>
		04	Priority given on the floor temperature

### 1.4.13 Compensating the Floor Temperature when Heating (For units with an infrared floor sensor only)

Offset the detected value of the infrared floor sensor with a certain temperature. This setting should be used to have the actual floor temperature detected when, for example, the unit is installed close to a wall.

★: Factory setting

Mode No.	First Code No.	Second Code No.	Contents
11 (21)	9	01	-4°C (-7.2°F)
		02	-2°C (-3.6°F)
		<b>03★</b>	<b>0°C (0°F)★</b>
		04	+2°C (+3.6°F)

#### Actual procedure to use the setting

Although the standard setting is normally used with no problem, the setting should be changed in the following cases:

Environment	Operation Mode	Problem	Setting Value
- The unit is installed close to a wall or a window. - High thermal capacity of the floor (such as concrete, etc.) - There are many heat sources including PC. - There is a non-negligible heat source such as floor heating.	Heating	Excessive heating	+2°C (+3.6°F)
		Insufficient heating	-2°C or -4°C (-3.6°F or -7.2°F)

### 1.4.14 Dry Mode Set Temperature (for FXFQ-AA, FXZQ-TB, FXUQ-PA, FXSQ-TB, FXMQ-TB, and FXMQ-TA models)

★: Factory setting

Mode No.	First Code No.	Second Code No.	Contents
11 (21)	12	<b>01★</b>	<b>Room temperature★</b>
		02	Same as cooling mode set temperature

### 1.4.15 Optional Accessories Output Selection

Using this setting, **operation output signal** and **abnormal output signal** can be provided. Output signal is output between terminals X1 and X2 of adaptor for wiring, an optional accessory.

★: Factory setting

Mode No.	First Code No.	Second Code No.	Contents
12 (22)	0	<b>01★</b>	<b>Indoor unit thermostat ON/OFF signal is provided. ★</b>
		02	—
		03	Output linked with ON/OFF of remote controller is provided.
		04	In case of Error Display appears on the remote controller, output is provided.
		05	—
		06	—
		07	Only for FXSQ-TA, FXSQ-TB, FXMQ-PB, FXMQ-TB Economizer (field supply) ON/OFF signal is provided.

### 1.4.16 External ON/OFF Input

This input is used for ON/OFF operation and protection device input from the outside. The input is performed from the T1-T2 terminal of the operation terminal block in the electrical component box.

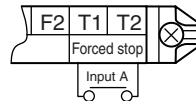

★: Factory setting

Mode No.	First Code No.	Second Code No.	Contents
12 (22)	1	<b>01★</b>	<b>ON: Forced stop (prohibition of using the remote controller) ★</b> <b>OFF: Permission of using the remote controller★</b>
		02	OFF → ON: Permission of operation ON → OFF: Stop
		03	ON: Operation OFF: The system stops, then the applicable unit indicates <b>A0</b> . The other indoor units indicate <b>U9</b> .
		04	—
		05	Only for FXSQ-TA, FXMQ-PB ON: Economizer (field supply) is connected. OFF: Not connected
		06	—
		07	Only for FXSQ-TB, FXMQ-TB ON: Economizer (field supply) is connected. OFF: Not connected

### 1.4.17 Thermostat Differential Changeover

Differential value during thermostat ON/OFF control can be changed.

Mode No.	First Code No.	Second Code No.	Contents
12 (22)	2	01	1°C (1.8°F)
		02	0.5°C (0.9°F)

#### Factory Setting

Model	Second Code No.	Contents
FXFQ-T, FXZQ-TA, FXUQ-P, FXEQ-P, FXSQ-TA, FXHQ-M, FXTQ-TA, FXTQ-TB	01	1°C (1.8°F)
FXFQ-AA, FXZQ-TB, FXUQ-PA, FXDQ-M, FXSQ-TB, FXMQ-PB, FXMQ-TB, FXMQ-TA, FXMQ-M, FXAQ-P, FXLQ-M, FXNQ-M, FXMQ-MF, CXTQ-TA	02	0.5°C (0.9°F)

### 1.4.18 Airflow Setting when Heating Thermostat is OFF

This setting is used to set airflow when heating thermostat is OFF.

If the airflow setting when thermostat is OFF is set to 03: OFF, the air in the indoor unit will be stagnant and suction air thermistor may not detect room temperature correctly, resulting in problems that thermostat will not be ON easily.

Use optional remote sensor in such conditions, or set the field setting 10 (20)-2 to **03** (only remote controller thermistor).

\* When thermostat OFF airflow volume up mode is used, careful consideration is required before deciding installation location.

★: Factory setting

Mode No.	First Code No.	Second Code No.	Contents
12 (22)	3	<b>01★</b>	<b>LL tap★</b>
		02	Set fan speed
		03	OFF

### 1.4.19 Automatic Mode Differential

This setting makes it possible to change differential values for mode selection while in automatic operation mode, only when the wireless remote controller or any central remote controller is connected.

★: Factory setting

Mode No.	First Code No.	Second Code No.							
		<b>01★</b>	02	03	04	05	06	07	08
12 (22)	4	<b>0°C (0°F)★</b>	1°C (1.8°F)	2°C (3.6°F)	3°C (5.4°F)	4°C (7.2°F)	5°C (9.0°F)	6°C (10.8°F)	7°C (12.6°F)

The automatic operation mode setting is made by the use of the operation mode selector button.

### 1.4.20 Auto Restart after Power Failure

★: Factory setting

Mode No.	First Code No.	Second Code No.	Contents
12 (22)	5	01	OFF
		<b>02★</b>	<b>ON★</b>

When the Auto Restart after Power Failure setting is turned OFF, all the units will remain OFF after power failure, or after the main power supply is restored. When this setting is turned ON (factory setting), the units that were operating before the power failure will automatically restart operation after power failure, or after the main power supply is restored.

Due to the aforementioned, when the Auto Restart after Power Failure setting is ON, be careful for the following situations that may occur.



**Caution**

- 1. The air conditioner will start operation suddenly after power failure, or when the main power supply is restored. The user might be surprised and wonder why the air conditioner turned ON suddenly.**
- 2. During maintenance, if the main power supply is turned OFF while the units are in operation, the units will automatically start operation (the fan will rotate) after the power supply is restored due to completion of the maintenance work.**

### 1.4.21 Airflow Setting when Cooling Thermostat is OFF

This is used to set airflow to LL airflow when cooling thermostat is OFF.

If the airflow setting when thermostat is OFF is set to 03: OFF, the air in the indoor unit will be stagnant and suction air thermistor may not detect room temperature correctly, resulting in problems that thermostat will not be ON easily.

Use optional remote sensor in such conditions, or set the field setting 10 (20)-2 to **03** (only remote controller thermistor).

★: Factory setting

Mode No.	First Code No.	Second Code No.	Contents
12 (22)	6	01	LL tap
		<b>02★</b>	<b>Set fan speed★</b>
		03	OFF

### 1.4.22 Ceiling Height Setting, Setting of Normal Airflow

Make the following setting according to the ceiling height. The second code No. is set to **01** at the factory.

■ **FXFQ07-24AA, FXFQ07-24T**

★: Factory setting

Mode No.	First Code No.	Second Code No.	Setting	Ceiling Height			
				All round outlet	4-way outlets	3-way outlets	2-way outlets
13 (23)	0	<b>01★</b>	<b>Standard★</b>	<b>Lower than 2.7 m (8-3/4 ft)★</b>	<b>Lower than 3.1 m (10-1/8 ft)★</b>	<b>Lower than 3.0 m (10 ft)★</b>	<b>Lower than 3.5 m (11-1/2 ft)★</b>
		02	High Ceiling (1)	Lower than 3.0 m (10 ft)	Lower than 3.4 m (11-1/8 ft)	Lower than 3.3 m (10-3/4 ft)	Lower than 3.8 m (12-1/2 ft)
		03	High Ceiling (2)	Lower than 3.5 m (11-1/2 ft)	Lower than 4.0 m (13-1/8 ft)	Lower than 3.5 m (11-1/2 ft)	—

**i** Note(s)

1. The Second Code No. is factory set to Standard/All round outlet. For High ceiling (1) or (2), initial setting by remote controller is required.
2. A closing member kit (optional) is required for 4-, 3-, or 2-direction airflow.

■ **FXFQ30-54AA, FXFQ30-48T**

★: Factory setting

Mode No.	First Code No.	Second Code No.	Setting	Ceiling Height			
				All round outlet	4-way outlets	3-way outlets	2-way outlets
13 (23)	0	<b>01★</b>	<b>Standard★</b>	<b>Lower than 3.2 m (10-1/2 ft)★</b>	<b>Lower than 3.4 m (11-1/8 ft)★</b>	<b>Lower than 3.6 m (12 ft)★</b>	<b>Lower than 4.2 m (13-3/4 ft)★</b>
		02	High Ceiling (1)	Lower than 3.6 m (12 ft)	Lower than 3.9 m (12-3/4 ft)	Lower than 4.0 m (13-1/8 ft)	Lower than 4.2 m (13-3/4 ft)
		03	High Ceiling (2)	Lower than 4.2 m (13-3/4 ft)	Lower than 4.5 m (14-3/4 ft)	Lower than 4.2 m (13-3/4 ft)	—

**i** Note(s)

1. The Second Code No. is factory set to Standard/All round outlet. For High ceiling (1) or (2), initial setting by remote controller is required.
2. A closing member kit (optional) is required for 4-, 3-, or 2-direction airflow.

## ■ FXZQ-TA, FXZQ-TB, FXEQ-P

★: Factory setting

Mode No.	First Code No.	Second Code No.	Contents	Ceiling height
13 (23)	0	<b>01★</b>	<b>Standard★</b>	<b>Lower than 2.7 m (8-3/4 ft) ★</b>
		02	High Ceiling 1	Lower than 3.0 m (10 ft)
		03	Higher Ceiling 2	Lower than 3.5 m (11-1/2 ft)

## ■ FXUQ-P, FXUQ-PA

★: Factory setting

Mode No.	First Code No.	Second Code No.	Setting	Ceiling height	
				FXUQ18/24P(A)	FXUQ30/36P(A)
13 (23)	0	<b>01★</b>	<b>Standard★</b>	<b>Lower than 2.7 m (8-3/4 ft)★</b>	<b>Lower than 3.2 m (10-1/2 ft)★</b>
		02	High Ceiling 1	Lower than 3.0 m (10 ft)	Lower than 3.6 m (12 ft)
		03	Higher Ceiling 2	Lower than 3.5 m (11-1/2 ft)	Lower than 4.0 m (13 ft)

## ■ FXMQ-TA

★: Factory setting

Mode No.	First Code No.	Second Code No.	Ceiling height
13 (23)	0	<b>01★</b>	<b>Standard★</b>
		02	High ceiling
		03	Higher ceiling

## ■ FXHQ-M, FXAQ-P

★: Factory setting

Mode No.	First Code No.	Second Code No.	Ceiling height
13 (23)	0	<b>01★</b>	<b>Standard★</b>
		02	Slight increase
		03	Normal increase

### 1.4.23 Airflow Direction Setting

Set the airflow direction of indoor units as given in the table below. (Set when sealing material kit of air discharge outlet has been installed.) The second code No. is factory set to **01**.

★: Factory setting

Mode No.	First Code No.	Second Code No.	Ceiling height
13 (23)	1	<b>01★</b>	<b>4-direction airflow★</b>
		02	3-direction airflow
		03	2-direction airflow

### 1.4.24 Swing Pattern Settings (For units with the infrared floor sensor only)

Set the flap operation in swing mode.

With the factory swing, flaps facing each other are synchronized to operate, and flaps placed side by side are set to swing in an opposite direction to agitate airflow to reduce temperature irregularity. Conventional swing operation (all direction synchronized swing) can be set onsite.

★: Factory setting

Mode No.	First Code No.	Second Code No.	Contents
13 (23)	2	01	All direction synchronized swing
		02	—
		<b>03★</b>	<b>Facing swing★</b>

### 1.4.25 Airflow Direction Adjustment Range

Make the following airflow direction setting according to the respective purpose.

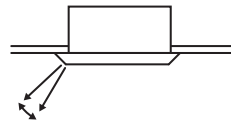

★: Factory setting

Mode No.	First Code No.	Second Code No.	Contents
13 (23)	4	01	Draft prevention (Upward)
		<b>02★</b>	<b>Standard★</b>
		03	Ceiling soiling prevention (Downward)



Note(s)

When the model FXFQ-AA is attached with a closing member kit, set the Second Code No. to **02** or **03**.

### 1.4.26 Setting of Static Pressure Selection

#### ■ FXDQ-M

★: Factory setting

Mode No.	First Code No.	Second Code No.	Contents
13 (23)	5	<b>01★</b>	<b>Standard (FXDQ07-12M: 10 Pa (0.04 inWG), FXDQ18/24M: 30 Pa (0.12 inWG))★</b>
		02	High static pressure (FXDQ07-12M: 15 Pa (0.06 inWG), FXDQ18/24M: 45 Pa (0.18 inWG))

#### ■ FXMQ-TA

★: Factory setting

Mode No.	First Code No.	Second Code No.	Contents
13 (23)	5	<b>01★</b>	<b>Standard★</b>
		02	Level 1
		03	Level 2



## 1.4.27 External Static Pressure Settings

Make external static pressure setting automatically using automatic airflow adjustment (11 (21)-7), or manually using external static pressure settings (13 (23)-6).

### ■ FXSQ-TA, FXSQ-TB models

★: Factory setting

Mode No.	First Code No.	Second Code No.	Contents
13 (23)	6	03	30 Pa (0.12 inWG) (*1) (*2)
		04	40 Pa (0.16 inWG) (*1) (*2)
		<b>05★</b>	<b>50 Pa (0.20 inWG) ★</b>
		06	60 Pa (0.24 inWG)
		07	70 Pa (0.28 inWG)
		08	80 Pa (0.32 inWG)
		09	90 Pa (0.36 inWG)
		10	100 Pa (0.40 inWG)
		11	110 Pa (0.44 inWG)
		12	120 Pa (0.48 inWG)
		13	130 Pa (0.52 inWG)
		14	140 Pa (0.56 inWG)
		15	150 Pa (0.60 inWG) (*2)

\*1. FXSQ18-48TA, FXSQ18-48TB cannot be set to 30-40 Pa (0.12-0.16 inWG).

\*2. FXSQ54TA, FXSQ54TB cannot be set to 30-40 Pa (0.12-0.16 inWG) or 150 Pa (0.60 inWG).

### ■ FXMQ-PB models

★: Factory setting

Mode No.	First Code No.	Second Code No.	Contents
13 (23)	6	01	30 Pa (0.12 inWG) (*1) (*3)
		<b>02★</b>	<b>50 Pa (0.20 inWG) ★</b>
		03	60 Pa (0.24 inWG)
		04	70 Pa (0.28 inWG)
		05	80 Pa (0.32 inWG)
		06	90 Pa (0.36 inWG)
		<b>07★</b>	<b>100 Pa (0.40 inWG) ★</b>
		08	110 Pa (0.44 inWG) (*2)
		09	120 Pa (0.48 inWG) (*2)
		10	130 Pa (0.52 inWG) (*2)
		11	140 Pa (0.56 inWG) (*2)
		12	150 Pa (0.60 inWG) (*2) (*3)
		13	160 Pa (0.64 inWG) (*2) (*3)
		14	180 Pa (0.72 inWG) (*2) (*3)
		15	200 Pa (0.80 inWG) (*2) (*3)

The Second Code No. is set to **02** for FXMQ07/09/12PB, and **07** for FXMQ15/18/24/30/36/48/54PB at factory setting.

\*1. FXMQ15/18/24/30/36/48PB cannot be set to 30 Pa (0.12 inWG).

\*2. FXMQ07/09/12PB cannot be set to 110-200 Pa (0.44-0.80 inWG).

\*3. FXMQ54PB cannot be set to 30 Pa (0.12 inWG) or 150-200 Pa (0.60-0.80 inWG).

## ■ FXMQ-TB models

★: Factory setting

Mode No.	First Code No.	Second Code No.	Contents
13 (23)	6	02	50 Pa (0.20 inWG)
		03	60 Pa (0.24 inWG)
		04	70 Pa (0.28 inWG)
		05	80 Pa (0.32 inWG)
		06	90 Pa (0.36 inWG)
		<b>07★</b>	<b>100 Pa (0.40 inWG) ★</b>
		08	110 Pa (0.44 inWG)
		09	120 Pa (0.48 inWG)
		10	130 Pa (0.52 inWG)
		11	140 Pa (0.56 inWG)
		12	150 Pa (0.60 inWG) (*1)
		13	160 Pa (0.64 inWG) (*1)
		14	180 Pa (0.72 inWG) (*1)
		15	200 Pa (0.80 inWG) (*1)

\*1. FXMQ54TB cannot be set to 150-200 Pa (0.60-0.80 inWG).

## ■ FXMQ-TA models

★: Factory setting

Mode No.	First Code No.	Second Code No.	Contents
13 (23)	6	01	50 Pa (0.20 inWG)
		02	75 Pa (0.30 inWG)
		03	100 Pa (0.40 inWG)
		04	115 Pa (0.46 inWG)
		05	130 Pa (0.52 inWG)
		<b>06★</b>	<b>150 Pa (0.60 inWG)★</b>
		07	160 Pa (0.64 inWG)
		08	175 Pa (0.70 inWG)
		09	190 Pa (0.76 inWG)
		10	200 Pa (0.80 inWG)
		11	210 Pa (0.84 inWG)
		12	220 Pa (0.88 inWG)
		13	230 Pa (0.92 inWG)
		14	240 Pa (0.96 inWG)
		15	250 Pa (1.00 inWG)

### 1.4.28 Optional Kit Setting (UV lamp + Humidifier + Economizer) (for FXTQ-TA, FXTQ-TB, CXTQ-TA models)

★: Factory setting

Mode No.	First Code No.	Second Code No.	Contents	
			UV lamp + humidifier fan speed	Economizer setting for Mech standby duration (minutes)
14 (24)	4	01	Refer to controller	10
		02	High	10
		03	Refer to controller	20
		04	High	20
		05	Refer to controller	30
		06	High	30
		07	Refer to controller	40
		08	High	40
		09	Refer to controller	50
		10	High	50
		11	Refer to controller	60
		12	High	60
		13	Refer to controller	Free cooling only
		<b>14★</b>	<b>High★</b>	<b>Free cooling only★</b>

### 1.4.29 Dry Mode Set Temperature (for FXTQ-TA, FXTQ-TB, CXTQ-TA models)

★: Factory setting

Mode No.	First Code No.	Second Code No.	Contents
14 (24)	5	<b>01★</b>	<b>Room temperature★</b>
		02	Same as cooling mode set temperature

### 1.4.30 Mold Proof Operation Setting (for FXEQ-P models)

★: Factory setting

Mode No.	First Code No.	Second Code No.	Contents
14 (24)	9	01	—
		<b>02★</b>	<b>Standard★</b>
		03	For high humidity areas (*)

\* Areas with average humidity over 80%.

### 1.4.31 Gas Furnace Test Mode (for CXTQ-TA models)

This setting is used for gas furnace test run.

For details, refer to **Gas Furnace Test Operation** on page 285.

★: Factory setting

Mode No.	First Code No.	Second Code No.	Contents
14 (24)	11	<b>01★</b>	<b>OFF★</b>
		02	Low heat
		03	High heat

### 1.4.32 Drain Pump Operation Settings

The drain pump operation can be disabled for natural drainage by changing the following field setting.

#### ■ FXMQ-PB

★: Factory setting

Mode No.	First Code No.	Second Code No.	Contents
15 (25)	0	01	—
		<b>02★</b>	<b>ON★</b>
		03	OFF

#### ■ FXMQ-TA

★: Factory setting

Mode No.	First Code No.	Second Code No.	Contents
15 (25)	0	01	OFF
		<b>02★</b>	<b>ON★</b>

### 1.4.33 Humidification when Heating Thermostat is OFF

Setting to **Equipped** turns ON the humidifier if suction air temperature is 20°C (68°F) or above and turns OFF the humidifier if suction air temperature is 18°C (64.4°F) or below when the heating thermostat is OFF.

★: Factory setting

Mode No.	First Code No.	Second Code No.	Contents
15 (25)	1	<b>01★</b>	<b>Not equipped★</b>
		02	Equipped

### 1.4.34 Direct Duct Connection

This is used when fresh air intake kit equipped with fan is connected. If the second code is set to **02**: Equipped, energy recovery ventilator fan conducts the fan residual operation by linking to indoor unit. The indoor fan carries out residual operation for one minute after the thermostat is stopped. (For the purpose of preventing dust on the air filter from falling off.)

★: Factory setting

Mode No.	First Code No.	Second Code No.	Contents
15 (25)	2	<b>01★</b>	<b>Not equipped★</b>
		02	Equipped

### 1.4.35 Drain Pump and Humidifier Interlock Selection

This is used to interlock the humidifier with the drain pump. When water is drained out of the unit, this setting is unnecessary.

★: Factory setting

Mode No.	First Code No.	Second Code No.	Contents
15 (25)	3	<b>01★</b>	<b>Not interlocked★</b>
		02	Interlocked

### 1.4.36 Individual Ventilation Setting

This is set to perform individual operation of Energy recovery ventilator using the remote controller/central unit when Energy recovery ventilator is built in.  
(Switch only when Energy recovery ventilator is built in.)

★: Factory setting

Mode No.	First Code No.	Second Code No.	Contents
15 (25)	5	<b>01★</b>	<b>Normal★</b>
		02	Individual

### 1.4.37 Display of Error Codes on the Remote Controller

■ For BRC1E73 only

Error code (four digits) is displayed for limited products. Select two-digit display if four-digit display is not preferred.

★: Factory setting

Mode No.	First Code No.	Second Code No.	Contents
1b	4	01	—
		02	Two-digit display
		03	—
		<b>04★</b>	<b>Four-digit display★</b>

### 1.4.38 Room Temperature Display

■ For BRC1E73 only

It is possible to change whether or not the room temperature is displayed for the detailed display screen.

★: Factory setting

Mode No.	First Code No.	Second Code No.	Contents
1c	0	01	Not displayed.
		<b>02★</b>	<b>Displayed.★</b>

### 1.4.39 Thermistor Sensor for Auto Changeover and Setback Control by the Remote Controller

■ For BRC1E73 only

Select a thermistor to utilize for the cool/heat mode automatic changeover and setback functions.  
The sensed temperature will be displayed on the remote controller as the room temperature.

★: Factory setting

Mode No.	First Code No.	Second Code No.	Contents
1c	1	01	Utilize the return air thermistor
		<b>02★</b>	<b>Utilize the remote controller thermistor★</b>

### 1.4.40 Access Permission Level Setting

■ For BRC1E73 only

There are 2 levels as follows:

- Level 2: The following buttons are selectable to be disable or enable.
- Level 3: No buttons are selectable and only **On/Off** button is available.

Button	Level 2	Level 3
▲▼◀▶	Selectable (Enable)	Unselectable (Disable)
On/Off	Selectable (Enable)	Unselectable (Enable)
Mode	Selectable (Enable)	Unselectable (Disable)
Fan Speed	Selectable (Disable)	Unselectable (Disable)
Menu/OK	Unselectable (Disable)	Unselectable (Disable)
Cancel	Unselectable (Disable)	Unselectable (Disable)

( ) shows the factory setting.

★: Factory setting

Mode No.	First Code No.	Second Code No.	Contents
1c	3	<b>01★</b>	<b>Level 2★</b>
		02	Level 3

### 1.4.41 Setback Availability

■ For BRC1E73 only

Select the operation mode in which the setback function is available.

★: Factory setting

Mode No.	First Code No.	Second Code No.	Contents
1e	2	<b>01★</b>	<b>N/A★</b>
		02	Heat only
		03	Cool only
		04	Cool/heat

### 1.4.42 Setting Restricted/Permitted for Airflow Block

■ For units with the infrared presence/floor sensor only

The airflow block function cannot be enabled when closure material kit, fresh air intake kit, separately installed natural evaporation type humidifier, or branch air duct is equipped, due to the possibility of dew condensation.

This setting restricts the airflow block function, preventing that the airflow block is inadvertently set to ON. Ensure that **Airflow block restricted** is set when using the options listed above.

★: Factory setting

Mode No.	First Code No.	Second Code No.	Contents
1e	14	<b>01★</b>	<b>Airflow block permitted★</b>
		02	—
		03	—
		04	—
		05	Airflow block restricted

# 1.5 Gas Furnace Set Up

Set-up for gas furnace is possible only by using the DIP switches located on CXTQ-TA. Gas furnace's DIP switch is not valid. Refer to the gas furnace's installation manual for details of each setting menu.



Note(s)

If the Heat OFF Delay time was changed to a longer time, warm-up process time of the heat pump might be longer.

★: Factory setting

Purpose	Function		Position			
	Modulating	2-Stage	1	2	3	4

Heat Airflow Trim	Dip switch		DS1			
	-15%	-10%	OFF	OFF	OFF	OFF
-12%	-8%	ON	OFF	OFF	OFF	
-9%	-6%	OFF	ON	OFF	OFF	
-6%	-4%	ON	ON	OFF	OFF	
-3%	-2%	OFF	OFF	ON	OFF	
<b>0%★</b>	<b>0%★</b>	<b>ON★</b>	<b>OFF★</b>	<b>ON★</b>	<b>OFF★</b>	
+3%	+2%	OFF	ON	ON	OFF	
+6%	+4%	ON	ON	ON	OFF	
+9%	+6%	OFF	OFF	OFF	ON	
+12%	+8%	ON	OFF	OFF	ON	
+15%	+10%	OFF	ON	OFF	ON	
	0%	ON	ON	OFF	ON	
	0%	OFF	OFF	ON	ON	
	0%	ON	OFF	ON	ON	
	0%	OFF	ON	ON	ON	
	0%	ON	ON	ON	ON	

Heat ON Delay	Dip switch	DS2			
	5 sec.	OFF	OFF	OFF	—
10 sec.	ON	OFF	OFF	—	
15 sec.	OFF	ON	OFF	—	
20 sec.	ON	ON	OFF	—	
25 sec.	OFF	OFF	ON	—	
<b>30 sec.★</b>	<b>ON★</b>	<b>OFF★</b>	<b>ON★</b>	<b>—★</b>	
30 sec.	OFF	ON	ON	—	
30 sec.	ON	ON	ON	—	

Heat OFF Delay	Dip switch	DS3			DS2
	<b>30 sec.★</b>	<b>OFF★</b>	<b>OFF★</b>	<b>—★</b>	<b>OFF★</b>
60 sec.	OFF	OFF	—	ON	
90 sec.	ON	OFF	—	OFF	
120 sec.	ON	OFF	—	ON	
150 sec.	OFF	ON	—	OFF	
180 sec.	OFF	ON	—	ON	
150 sec.	ON	ON	—	OFF	
150 sec.	ON	ON	—	ON	

Dip switch		DS3			
Heating Speed Tap	A	—	—	OFF	OFF
	<b>B★</b>	<b>==★</b>	<b>==★</b>	<b>ON★</b>	<b>OFF★</b>
	C	—	—	OFF	ON
	D	—	—	ON	ON

## 1.6 List of Field Settings for Outdoor-Air Processing Unit

★: Factory setting

Mode No.	First Code No.	Setting Contents	Second Code No.														
			01	02	03	04	05	06	07	08	09	10	11	12	13	14	15
10 (20)	0	Filter contamination	<b>2500 hr</b> ★	1250 hr	—	—	—	—	—	—	—	—	—	—	—	—	—
	3	Display time to clean air filter calculation	<b>Display</b> ★	No display	—	—	—	—	—	—	—	—	—	—	—	—	—
12 (22)	1	External ON/OFF input	<b>Forced OFF</b> ★	ON/OFF control	—	—	—	—	—	—	—	—	—	—	—	—	—
	5	Power failure automatic reset	Not equipped	<b>Equipped</b> ★	—	—	—	—	—	—	—	—	—	—	—	—	—
14 (24)	3	Discharge pipe temperature (cooling)	°C	13	14	15	16	17	<b>18</b> ★	19	20	21	22	23	24	25	
			°F	55.4	57.2	59	60.8	62.6	<b>64.4</b> ★	66.2	68	69.8	71.6	73.4	75.2	77	
	4	Discharge pipe temperature (heating)	°C	18	19	20	21	22	23	24	<b>25</b> ★	26	27	28	29	30	
			°F	64.4	66.2	68	69.8	71.6	73.4	75.2	<b>77</b> ★	78.8	80.6	82.4	84.2	86	

## 1.7 Operation Control Mode

The operation control mode is compatible with a variety of controls and operations by limiting the functions of the operation remote controller. Furthermore, operations such as remote controller ON/OFF can be limited in accordance with the combination conditions. (Refer to information on the next page.)

Central remote controller is normally available for operations. (Except when centralized monitor is connected)

### Contents of Control Modes

20 modes consisting of combinations of the following 5 operation modes with temperature and operation mode setting by remote controller can be set and displayed by operation modes 0 through 19.

- ON/OFF control impossible by remote controller  
Used when you want to turn ON/OFF by central remote controller only. (Cannot be turned ON/OFF by remote controller.)
- OFF control only possible by remote controller  
Used when you want to turn ON by central remote controller only, and OFF by remote controller only.
- Centralized  
Used when you want to turn ON by central remote controller only, and turn ON/OFF freely by remote controller during set time.
- Individual  
Used when you want to turn ON/OFF by both central remote controller and remote controller.
- Timer operation possible by remote controller  
Used when you want to turn ON/OFF by remote controller during set time and you do not want to start operation by central remote controller when time of system start is programmed.



**How to Select Operation Mode**

Whether operation by remote controller will be possible or not for turning ON/OFF, controlling temperature or setting operation mode is selected and decided by the operation mode given on the right edge of the table below.

**Example**

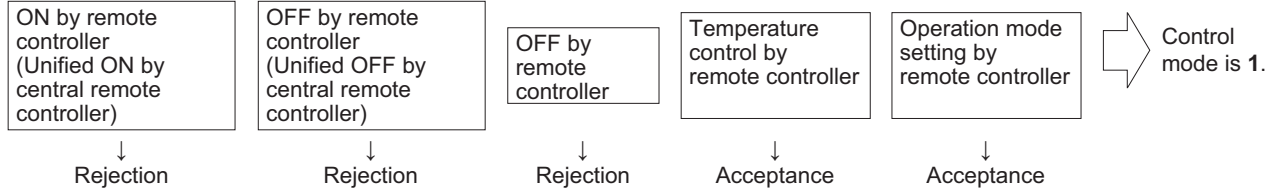

★: Factory setting

Control mode	Control by remote controller					Control mode
	Operation		OFF	Temperature control	Operation mode setting	
	Unified operation, individual operation by central remote controller, or operation controlled by timer	Unified OFF, individual stop by central remote controller, or timer stop				
ON/OFF control impossible by remote controller	Rejection (Example)	Rejection (Example)	Rejection (Example)	Rejection	Acceptance	0
OFF control only possible by remote controller				Acceptance (Example)	Acceptance (Example)	1 (Example)
Centralized	Acceptance	Acceptance	Acceptance	Rejection	Acceptance	2
Individual				Acceptance	Rejection	12
				Acceptance	Acceptance	3
Timer operation possible by remote controller				Acceptance (During timer at ON position only)	Rejection (During timer at OFF position only)	Acceptance
				Rejection	Acceptance	4
				Acceptance	Rejection	14
				Rejection	Acceptance	5
				Acceptance	Rejection	15
				Rejection	Acceptance	6
				Acceptance	Rejection	16
				Rejection	Acceptance	7★
				Acceptance	Rejection	17
				Rejection	Acceptance	8
				Acceptance	Rejection	18
				Rejection	Acceptance	9
				Acceptance	Rejection	19

Do not select **Timer operation possible by remote controller** if not using a remote controller. Operation by timer is impossible in this case.

Local remote controllers cannot set temperature or operation mode when the system is under centralized control and **CENTRAL CONTROL** is displayed on the screen.

**BRC1E73**

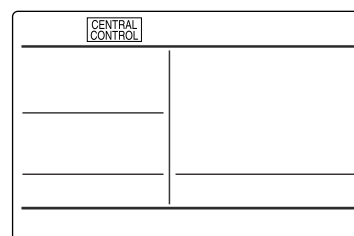

## 2. Field Setting from Outdoor Unit

To continue the configuration of the **VRV** heat recovery system, it is required to give some input to the PCB of the unit. This chapter will describe how manual input is possible by operating the BS buttons/DIP switches on the PCB and reading the feedback from the 7 segment displays.

For **VRV** heat recovery system it is alternatively possible to make several commissioning field setting through a personal computer interface (for this, an optional cable is required). The installer can prepare the configuration (off-site) on PC and afterwards upload the configuration to the system.

### 2.1 DIP Switch Setting when Mounting a Spare PCB



**Caution**

- After replacement with spare PCB, be sure to make settings shown in the table on the following page. The procedure for making settings of spare PCB is different from that used for factory settings described above. Be sure to refer to the table shown on the following page in order to make settings of spare PCB after replacement.
- Enforce a re-initialization of communication: hold press the **RETURN (BS3)** button for minimum 5 seconds.
- After initialization, a test operation is required from outdoor unit (hold the **SET (BS2)** button until indication **t01** appears).

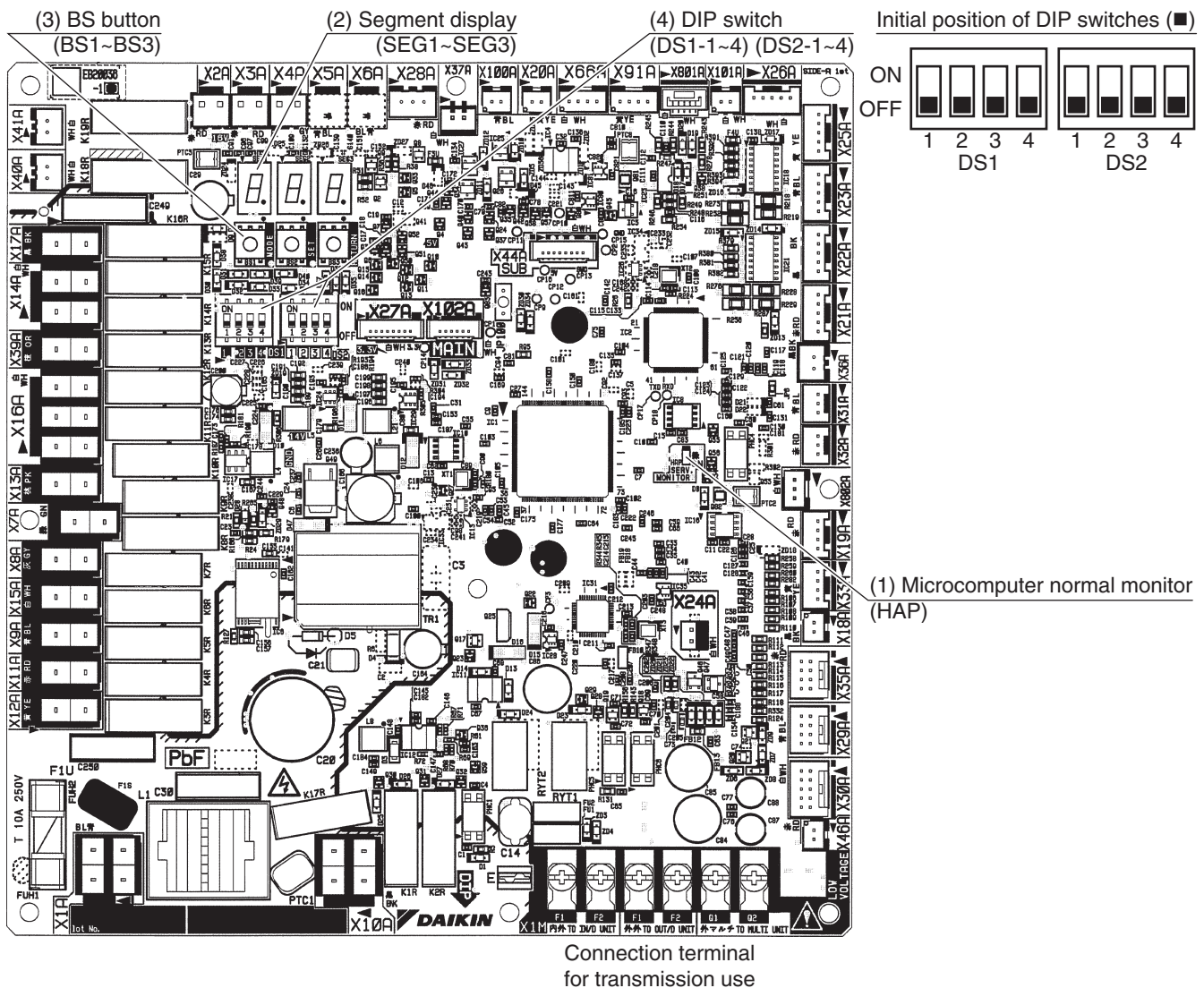

## (1) Microcomputer normal monitor

This monitor blinks while in normal control, and turns ON or OFF when an error occurs.

## (2) Segment display

Used to check the transmission and display the transmission state between indoor and outdoor units, the contents of error, and the contents of field setting.

## (3) BS button

Used to change mode.

## (4) DIP switch

Used to make field settings.

The figure below shows the required position of the DIP switches on spare PCB for REYQ-AA. Change DIP switches at time of power disconnected.

Application model	The setting method (■ represents the position of switches)	
REYQ72AA		Set DS2-2 to ON.
REYQ96AA		Set DS2-1 and DS2-2 to ON.
REYQ120AA		Set DS2-3 to ON.
REYQ144AA		Set DS2-2 and DS2-3 to ON.
REYQ168AA		Set DS2-1, DS2-2 and DS2-3 to ON.
REYQ192AA		Set DS2-4 to ON.
REYQ216AA		Set DS2-1 and DS2-4 to ON.
REYQ240AA		Set DS2-1, DS2-2 and DS2-4 to ON.

## 2.2 Accessing the BS Buttons on the PCB

It is not required to open the complete electronic component box to access the BS buttons on the PCB and read out the seven-segment display(s).

1. Open the service window cover.
2. Open the inspection door.

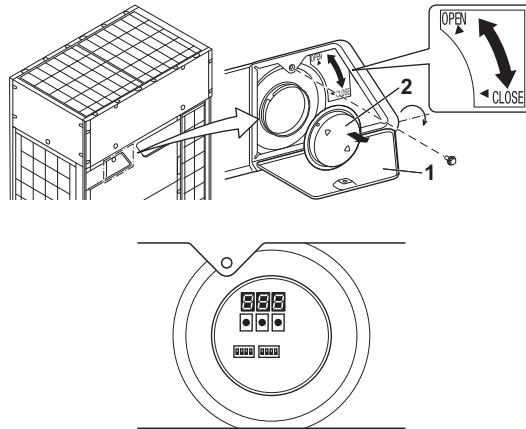

You can see the 3 BS buttons and the 3 seven-segment displays and DIP switches.

Operate the switches and BS buttons with an insulated stick (such as a closed ballpoint pen) to avoid touching of live parts.

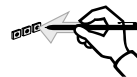

Location of the seven-segment displays, buttons and DIP switches:

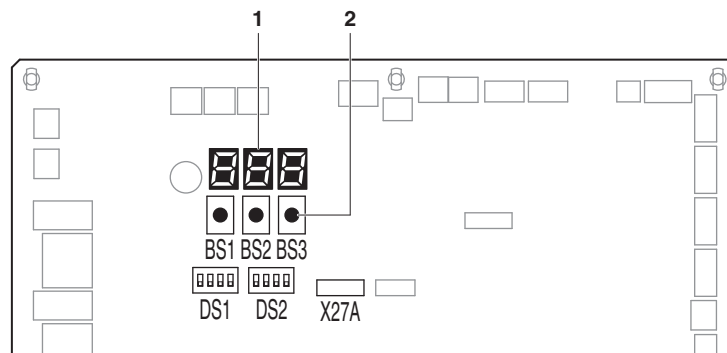

- MODE (BS1)** for changing setting mode
- SET (BS2), RETURN (BS3)** for changing field setting
- DS1, DS2** DIP switches
- 1** Seven-segment displays (3x)
- 2** BS buttons (3x)

Segment display indications:



## 2.3 Operating the BS Buttons and DIP Switches on the PCB

### Operating the BS buttons

By operating the BS buttons it is possible to:

- Perform special actions (test operation, etc.).
- Perform field settings (demand operation, low noise, etc.).

Below procedure explains how to operate the BS buttons to reach the required mode in the menu, select the correct setting and modify the value of the setting. This procedure can be used any time special settings and regular field setting are discussed in this manual.

Setting definition: [A-B] → C

A: mode

B: setting

C: setting value

A, B and C are numerical values for field settings. Parameter C has to be defined. It can be a chosen from a set (0, 1, 2, 3, 4, 5,...) or regarded as an ON/OFF (1 or 0) depending on the contents. This is informed when the field setting is explained.



**INFORMATION** During special operation (e.g., test operation, etc.) or when an error happened, information will contain letters and numerical values.

### Initialization: Default Situation

Turn ON the power supply of the outdoor unit and all indoor units.

When the communication between indoor units and outdoor unit(s) is established and normal, the segment indication state will be as below (default situation when shipped from factory).

When turning ON the power supply, the display blinks ON and OFF. First checks of the power supply are executed (1 - 2 minutes).

888

When no trouble occurs: lighted as indicated (8~10 minutes).

888

Ready for operation: blank display indication as indicated.

888

When above situation cannot be confirmed after 12 minutes, the error code can be checked on the indoor unit user interface and the outdoor unit segment display. Solve the error code accordingly. The communication wiring should be checked at first.



**INFORMATION** Be sure to turn the power on at least 6 hours before operation in order to have power running to the crankcase heater.

**Accessing modes**

The **MODE (BS1)** button is used to change the mode you want to access.

- **Access mode 1**

Press the **MODE (BS1)** button once. Segment indication changes to:



- **Access mode 2**

Press the **MODE (BS1)** button for at least 5 seconds. Segment indication changes to:



**INFORMATION** If you get confused in the middle of the process, press the **MODE (BS1)** button. Then it returns to idle situation (no indication on segment displays: blank).

**Mode 1**

Mode 1 is used to set basic settings and to monitor the status of the unit.

- Changing and access the setting in mode 1:

Once mode 1 is selected (press the **MODE (BS1)** button once), you can select the wanted setting. It is done by pressing the **SET (BS2)** button. Accessing the selected setting's value is done by pressing the **RETURN (BS3)** button once.

- To quit and return to the initial status, press the **MODE (BS1)** button.

**Example:**

Checking the content of parameter [1-10] (to know how many indoor units are connected to the system).

Mode: 1

Setting: 10

- Make sure the segment indication is displayed in operational default mode as shipped from factory.
- Press the **MODE (BS1)** button once; result segment display:



Result: mode 1 is accessed.

- Press the **SET (BS2)** button 10 times; result segment display:



Result: mode 1 setting 10 is addressed.

- Press the **RETURN (BS3)** button once; the value which is returned (depending on the actual field situation), is the amount of indoor units which are connected to the system.

Result: mode 1 setting 10 is addressed and selected, return value is monitored information.

- To leave the monitoring function, press the **MODE (BS1)** button once, you will return to the default situation when shipped from factory.

## Mode 2

Mode 2 is used to set field settings of the outdoor unit and system.

- Changing and access the setting in mode 2:

Once mode 2 is selected (press the **MODE (BS1)** button for more than 5 seconds), you can select the wanted setting. It is done by pressing the **SET (BS2)** button.

Accessing the selected setting's value is done by pressing the **RETURN (BS3)** button once.

- To quit and return to the initial status, press the **MODE (BS1)** button.
- Changing the value of the selected setting in mode 2:
  - ◆ Once mode 2 is selected (press the **MODE (BS1)** button for more than 5 seconds) you can select the wanted setting. It is done by pressing the **SET (BS2)** button.
  - ◆ Accessing the selected setting's value is done by pressing the **RETURN (BS3)** button once.
  - ◆ Now the **SET (BS2)** button is used to select the required value of the selected setting.
  - ◆ When the required value is selected, you can define the change of value by pressing the **RETURN (BS3)** button once.
  - ◆ Press the **RETURN (BS3)** button again to start operation according to the chosen value.

### Example:

Checking the content of parameter [2-18] (to define the high static pressure setting of the outdoor unit's fan).

Mode: 2

Setting: 18

Make sure the segment indication is as during normal operation (default situation when shipped from factory).

- Press the **MODE (BS1)** button for over 5 seconds; result segment display:

Result: mode 2 accessed.

- Press the **SET (BS2)** button 18 times; result segment display:

Result: mode 2 setting 18 is addressed.

- Press the **RETURN (BS3)** button once; the value which is returned (depending on the actual field situation), is the status of the setting. In the case of [2-18], default value is "0", which means the function is not active.

Result: mode 2 setting 18 is addressed and selected, return value is the current setting situation.

- To change the value of the setting, press the **SET (BS2)** button until the required value appears on the segment indication. When achieved, define the setting value by pressing the **RETURN (BS3)** button once. To start operation according to the chosen setting, confirm again by pressing the **RETURN (BS3)** button.
- To leave the field setting, press the **MODE (BS1)** button once, you will return to the default situation when shipped from factory.

## 2.4 Connecting the PC Configurator to the Outdoor Unit

Connection of the optional PC configurator cable to the outdoor unit has to be done on A1P.  
Connect the optional cable to the 8-pin white connector X27A.



### Caution

Works executed on the outdoor unit are best done under dry weather conditions to avoid water ingress.

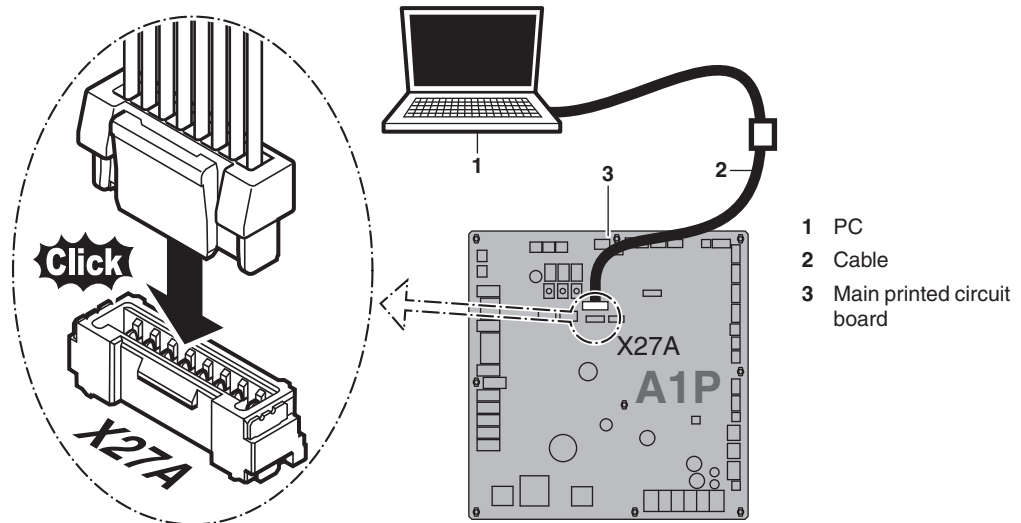

## 2.5 Monitoring Function and Field Settings

The operation of the outdoor unit can further be defined by changing some field settings. Next to making field settings it is also possible to confirm the current operation parameters of the unit. The setting can also be performed via the PC configuration software.

Below relevant Monitoring mode (mode 1) and Field setting mode (mode 2) settings are explained in detail.

Making settings is done via the master outdoor unit.

### 2.5.1 Mode 1

Mode 1 can be used to monitor the current situation of the outdoor unit. Some field setting contents can be monitored as well.

Below the settings in mode 1 are explained.

[1-0]: shows whether the unit you are checking is a master or sub unit.

- No indication: undefined situation
- 0: outdoor unit is master unit
- 1: outdoor unit is sub unit

Master and sub indications are relevant in multiple outdoor unit system configurations. The allocation of which outdoor unit is master or sub are decided by the unit's logic.

**The master unit must be used to input field settings in mode 2.**



- [1-1]: shows the status of night-time low noise operation.  
 ■ 0: unit is currently not operating under low noise restrictions  
 ■ 1: unit is currently operating under low noise restrictions
- Night-time low noise operation reduces the sound generated by the unit compared to nominal operating conditions.  
 Night-time low noise operation can be set in mode 2. There are two methods to activate night-time low noise operation of the outdoor unit system.  
 The first method is to enable an automatic night-time low noise operation by field setting. The unit will operate at the selected low noise level during the selected time frames.  
 The second method is to enable night-time low noise operation based on an external input. For this operation an optional accessory is required.
- [1-2]: shows the status of power consumption limitation operation.  
 ■ 0: unit is currently not operating under power consumption limitations  
 ■ 1: unit is currently operating under power consumption limitation
- Power consumption limitation reduces the power consumption of the unit compared to nominal operating conditions.  
 Power consumption limitation can be set in mode 2.  
 There are two methods to activate power consumption limitation of the outdoor unit system.  
 The first method is to enable a forced power consumption limitation by field setting. The unit will always operate at the selected power consumption limitation.  
 The second method is to enable power consumption limitation based on an external input. For this operation an optional accessory is required.
- [1-5]: shows the current  $T_e$  target parameter position.  
 [1-6]: shows the current  $T_c$  target parameter position.  
 [1-9]: shows the AIRNET address.  
 [1-10]: shows the total number of connected indoor units.  
 It can be convenient to check if the total number of indoor units which are installed match the total number of indoor units which are recognized by the system. In case there is a mismatch, it is advised to check the communication wiring path between outdoor and indoor units (F1/F2 communication line).
- [1-11]: shows the total number of connected Branch Selector units.  
 Check if the total number of installed Branch Selector units match the total number of Branch Selector units recognized by the system. In case there is a mismatch, check the communication wiring path between outdoor and Branch Selector units (F1/F2 communication line).  
 For the Multi Branch Selector unit, the number of units in use is counted.
- [1-13]: shows the total number of connected outdoor units.  
 It can be convenient to check if the total number of outdoor units which are installed matches the total number of outdoor units which are recognized by the system. In case there is a mismatch, it is advised to check the communication wiring path between outdoor and outdoor units.
- [1-17]: shows the latest error code.  
 [1-18]: shows the 2nd last error code.  
 [1-19]: shows the 3rd last error code.  
 When the latest error codes were reset by accident on an indoor unit user interface, they can be checked again through this monitoring settings.
- [1-35]: shows the latest prediction code.

- [1-36]: shows the 2nd last prediction code.
- [1-37]: shows the 3rd last prediction code.
- [1-40]: shows the current cooling comfort setting.
- [1-41]: shows the current heating comfort setting.
- [1-42]: shows the current high pressure sensor value (psi).
- [1-43]: shows the current low pressure sensor value (psi).
- [1-44]: shows the current compressor speed (Hz).
- [1-45]: shows the current EEV (heat exchanger upper) opening (pulse divided by 10).
- [1-46]: shows the current EEV (heat exchanger lower) opening (pulse divided by 10).
- [1-47]: shows the current compressor 1 discharge thermistor value (°F).
- [1-48]: shows the current compressor 2 discharge thermistor value (°F).
- [1-49]: shows the current compressor 1 body thermistor value (°F).
- [1-50]: shows the current outdoor air thermistor value (°F).
- [1-51]: shows the current compressor suction thermistor value (°F).
- [1-52]: shows the current subcooling gas thermistor value (°F).
- [1-53]: shows the current heat exchanger gas (upper) thermistor value (°F).
- [1-54]: shows the current heat exchanger gas (lower) thermistor value (°F).
- [1-55]: shows the current deicer right thermistor value (°F).
- [1-56]: shows the compressor run time (hour divided by 100).
- [1-57]: shows the current subcooling of (heat exchanger right) (°F).
- [1-58]: shows the current EEV (heat exchanger left) opening (pulse divided by 10).
- [1-59]: shows the current subcooling of (heat exchanger left) (°F).
- [1-60]: shows the current compressor 2 body thermistor value (°F).
- [1-61]: shows the current subcooling liquid thermistor value (°F).
- [1-62]: shows the current suction pipe thermistor value (°F).
- [1-63]: shows the current receiver inlet thermistor value (°F).
- [1-64]: shows the current heat exchanger liquid (upper) thermistor value (°F).
- [1-65]: shows the current heat exchanger liquid (lower) thermistor value (°F).
- [1-66]: shows the current heat exchanger liquid (left) thermistor value (°F).
- [1-67]: shows the current deicer (left) thermistor value (°F).
- [1-68]: shows the current heat exchanger gas (left) thermistor value (°F).
- [1-69]: shows the compressor average load.
- [1-70]: shows the current receiver gas purge thermistor value (°F).
- [1-71]: shows the current subcooling injection thermistor value (°F).
- [1-72]: shows the current electrical components box thermistor value (°F).
- [1-73]: shows the current cooling jacket outlet thermistor value (°F).

## 2.5.2 Overview of Setting Mode (Mode 2)

This overview shows the available settings by using the press buttons on the outdoor unit PCB.

No. *1	Item	Description	7 segment display			Description	7 segment display		
			SEG 1	SEG 2	SEG 3		Range		
							SEG 1	SEG 2	SEG 3
0	COOL/HEAT selection	Several systems as 1 zone change over COOL/HEAT: ■ INDIVIDUAL: VRV indoor unit or A-B-C input set mode. ■ MASTER: System is the COOL/HEAT master unit. ■ SUB: System is not a COOL/HEAT master.	2.	0	0	<b>Individual</b> Unified Master Unified Sub			<b>0</b> 1 2
2	Low noise/demand address	Used to make address setting for low noise/demand operation.	2.	0	2	Address: <b>0 ~ 31</b>		3	<b>0</b> 1
5	Indoor fan forced H	Used to force the fan of indoor unit to H tap.	2.	0	5	<b>Normal operation</b> Indoor fan H			<b>0</b> 1
6	Forced thermostat	Used to force all indoor units to operate forced thermostat ON.	2.	0	6	<b>Normal operation</b> Forced thermostat ON			<b>0</b> 1
7	Eco level setting for Eco mode via External control adaptor	Used to make setting of Eco level for Eco mode via External control adaptor	2.	0	7	<b>Inactive</b> Eco mode active by low noise terminal short-circuit Eco mode active by demand terminal short-circuit			<b>0</b> 1 2
8	Te setting	Used to make setting of targeted evaporating temperature for cooling operation.	2.	0	8	Auto <b>6°C (42.8°F)</b> 7°C (44.6°F) 8°C (46.4°F) 9°C (48.2°F) 10°C (50.0°F) 11°C (51.8°F)			<b>0</b> 2 3 4 5 6 7
9	Tc setting	Used to make setting of targeted condensing temperature for heating operation.	2.	0	9	Auto 41°C (105.8°F) 43°C (109.4°F) <b>46°C (114.8°F)</b>			<b>0</b> 1 3 6
10	The heating capacity cut offset temperature setting	Used for heating capacity cut offset temperature setting.	2.	1	0	<b>Default 2.0°C (3.6°F)</b> 1.0°C (1.8°F) 0.5°C (0.9°F)			<b>0</b> 1 2
12	External low noise setting/demand setting	Used to receive external low noise or demand signal.	2.	1	2	Input LNO/DE <b>OFF</b> ON			<b>0</b> 1
13	AIRNET address	Used to set address of AIRNET.	2.	1	3	Address: <b>0 ~ 63</b>		6	<b>0</b> 3
16	Heat pump lockout 1	Used for heat pump lockout.	2.	1	6	<b>OFF</b> ON			<b>0</b> 1
18	High ESP setting FAN	Fan high static pressure setting	2.	1	8	<b>OFF</b> ON			<b>0</b> 1
19	Phased installation setting	Used to make setting for phased installation.	2.	1	9	<b>Normal installation</b> Single module to dual module installation			<b>0</b> 1
20	Additional refrigerant charge/Wrong wiring automatic detection for Branch Selector	Used to perform additional refrigerant charging operation (compressor operation) and wrong wiring automatic detection for Branch Selector.	2.	2	0	<b>OFF</b> Refrigerant charging ON Wrong wiring automatic detection ON			<b>0</b> 1 2
21	Refrigerant recovery and vacuuming	Used to set the system to refrigerant recovery mode (without compressor run).	2.	2	1	Refrigerant recovery <b>OFF</b> ON			<b>0</b> 1
22	Automatic night-time low noise operation	Automatic night-time low noise operation. Time for the operation is subject to the start and end time settings.	2.	2	2	<b>OFF</b> Level 1 Level 2 Level 3			<b>0</b> 1 2 3

No. *1	Item	Description	7 segment display			Description	7 segment display		
			Range				Range		
			SEG 1	SEG 2	SEG 3		SEG 1	SEG 2	SEG 3
25	External low noise level	Low noise level when the external low noise signal is input at option DTA104A62.	2.	2	5	Level 1 <b>Level 2</b> Level 3			1 <b>2</b> 3
26	Automatic night-time low noise operation start	Time to start automatic “night-time low noise” operation. (“Night-time low noise” level setting should also be made.)	2.	2	6	About 8:00 PM <b>About 10:00 PM</b> About 12:00 AM			1 <b>2</b> 3
27	Automatic night-time low noise operation stop	Time to stop automatic “night-time low noise” operation. (“Night-time low noise” level setting should also be made.)	2.	2	7	About 6:00 AM About 7:00 AM <b>About 8:00 AM</b>			1 2 <b>3</b>
28	Power transistor check	Used to troubleshoot DC compressor. Inverter waveforms are output without wire connections to the compressor. It is useful to determine whether the relevant trouble has resulted from the compressor or inverter PCB.	2.	2	8	<b>OFF</b> ON (10 Hz)			<b>0</b> 1
29	Intermittent fan operation	Used for intermittent fan operation setting.	2.	2	9	<b>OFF</b> 30 minutes OFF, 1 minute ON with medium fan speed 30 minutes OFF, 1 minute ON with high fan speed 15 minutes OFF, 1 minute ON with medium fan speed 15 minutes OFF, 1 minute ON with high fan speed 5 minutes OFF, 1 minute ON with medium fan speed 5 minutes OFF, 1 minute ON with high fan speed Continuously ON with medium fan speed			<b>0</b> 1 2 3 4 5 6 7
30	Demand 1 setting	Used to make a change to the targeted power consumption level when the demand 1 control signal is inputted.	2.	3	0	Level 1 (60%) Level 2 (65%) <b>Level 3 (70%)</b> Level 4 (75%) Level 5 (80%) Level 6 (85%) Level 7 (90%) Level 8 (95%)			1 2 <b>3</b> 4 5 6 7 8
31	Demand 2 setting	Used to use a targeted power current level when the demand 2 control signal is input.	2.	3	1	<b>Level 1 (40%)</b> Level 2 (50%) Level 3 (55%)			<b>1</b> 2 3
32	Normal demand setting	Used to set permanent demand 1 or 2 control without inputting any external signal.	2.	3	2	<b>OFF</b> Demand 1 (2-30) Demand 2 (2-31)			<b>0</b> 1 2

No. *1	Item	Description	7 segment display			Description	7 segment display		
			Range				Range		
			SEG 1	SEG 2	SEG 3		SEG 1	SEG 2	SEG 3
34	Indoor fan tap setting	Indoor fan speed is limited to L tap depending on connection capacity and outdoor air temperature (Ta).  *1. Indoor condition A: Temperature difference average of (indoor air temperature – set temperature) is less than 1.5°C (2.7°F). *2. Indoor condition B: Temperature difference average of (indoor air temperature – set temperature) is 3°C (5.4°F) or more.	2.	3	4	<b>Indoor capacity ≥ 130%</b>			<b>0</b>
						Indoor capacity ≥ 130% in heating			1
						Remote controller setting (Not limited)			2
						Limited in cooling when Ta < 29.5°C (85.1°F) and Indoor condition is in condition A (*1) Returned when Ta > 32.5°C (90.5°F) or Indoor condition is in condition B (*2)			3
						Limited in cooling when Ta < 23.5°C (74.3°F) and Indoor condition is in condition A (*1) Returned when Ta > 26.5°C (79.7°F) or Indoor condition is in condition B (*2)			4
						Limited in cooling when Ta < 19.3°C (66.7°F) and Indoor condition is in condition A (*1) Returned when Ta > 22.3°C (72.1°F) or Indoor condition is in condition B (*2)			5
						Limited in cooling when Ta < 29.5°C (85.1°F) Returned when Ta > 32.5°C (90.5°F)			6
						Limited in cooling when Ta < 23.5°C (74.3°F) Returned when Ta > 26.5°C (79.7°F)			7
							8		
35	Outdoor > 40 m (130 ft) below indoor	To increase Tc target heating.	2.	3	5	Level > 40 m (130 ft)			<b>0</b>
						<b>Level max. 40 m (130 ft)</b>			<b>1</b>
						Do not use			<b>~</b>
									<b>7</b>
37	Heat pump lockout 2	Used for heat pump lockout	2.	3	7	<b>OFF</b>			<b>0</b>
						Mode 1			<b>1</b>
						Mode 2			<b>2</b>
						Mode 3			<b>3</b>
						Mode 4			<b>4</b>
						Mode 5			<b>5</b>
Mode 6			<b>6</b>						
38	Emergency operation (master)	To prohibit a compressor or complete in "Master". Since module is permanent disabled, immediately replace the defective component(s).	2.	3	8	<b>OFF</b>			<b>0</b>
						Master INV. 1 OFF			<b>1</b>
						Master INV. 2 OFF			<b>2</b>
						Master unit OFF			<b>3</b>
39	Emergency operation (sub)	To prohibit a compressor or complete "sub 1". Since module is permanent disabled, immediately replace the defective component(s).	2.	3	9	<b>OFF</b>			<b>0</b>
						Sub INV. 1 OFF			<b>1</b>
						Sub INV. 2 OFF			<b>2</b>
						Sub unit OFF			<b>3</b>
42	Outdoor fan	Outdoor fan noise countermeasure (limit fan speed).	2.	4	2	<b>Standard</b>			<b>0</b>
						Mode A			<b>1</b>
						Mode B			<b>2</b>
45	Low ambient cooling	Low ambient cooling function setting. (This setting is not applicable to BS-Q54TVJ models.)	2.	4	5	<b>Low ambient cooling not available</b>			<b>0</b>
						Low ambient cooling available			<b>1</b>

No. *1	Item	Description	7 segment display			Description	7 segment display		
			Range				SEG 1	SEG 2	SEG 3
			SEG 1	SEG 2	SEG 3				
47	Te setting (Heat recovery operation)	Used to make setting of targeted evaporating temperature for heat recovery operation.	2.	4	7	Auto <b>6°C (42.8°F)</b> 7°C (44.6°F) 8°C (46.4°F) 9°C (48.2°F) 10°C (50.0°F) 11°C (51.8°F)			0 2 3 4 5 6 7
49	Outdoor > 50 m (164 ft) above indoor	Height difference setting max. 110 m (361 ft).	2.	4	9	<b>Off (max. 50 m (164 ft))</b> On (max 110 m (361 ft))			0 1
51	Sequence multi outdoor	Sequence addressing between master and sub units.	2.	5	1	<b>Automatic</b> Forced master Forced sub			0 1 2
60	Gas furnace setting	Used for gas furnace connection	2.	6	0	<b>No gas furnace connection</b> Gas furnace connection			0 1
62	Cooling/Heating capacity learning control	Adjust cooling and heating capacity learning control	2.	6	2	<b>OFF</b> Cooling adjustment Heating adjustment Cooling and heating adjustment			0 1 2 3
64	Eco mode invalid setting	Used to make setting of Eco mode invalid When this configuration is set, it is not possible to turn Eco mode ON/OFF using external control adaptor or other setting.	2.	6	4	<b>Activated both cooling and heating</b> Activated heating only Activated cooling only Deactivated			0 1 2 3
71	Branch selector switching time	Used for changing branch selector switching time All piping length between branch selector unit and indoor units should be less than 9.7 m (32 ft).	2.	7	1	<b>Standard</b> Approximately 4 minutes			0 1
78	Heat pump lockout temperature	Heat pump is locked out when the outdoor air temperature is smaller than the heat pump lockout temperature.	2.	7	8	<b>-26.1°C (-15°F)</b> -23.3°C (-10°F) -20.5°C (-5°F) -17.7°C (0°F) -15°C (5°F) -12.2°C (10°F) -9.4°C (15°F) -6.6°C (20°F) -3.8°C (25°F) -1.1°C (30°F) 1.6°C (35°F) 4.4°C (40°F) 7.2°C (45°F) 10°C (50°F) Forced heat pump lockout		1 1 1 1 1	0 1 2 3 4 5 6 7 8 9 0 1 2 3 4
79	Heat pump lockout release differential	Heat pump would be resumed when the outdoor air temperature is recovered by differential above the heat pump lockout temperature.	2.	7	9	2.8°C (5°F) <b>5.6°C (10°F)</b> 8.3°C (15°F)			0 1 2
81	Cooling comfort setting	Cooling comfort setting for VRT control	2.	8	1	Eco <b>Mild</b> Quick Powerful			0 1 2 3
82	Heating comfort setting	Heating comfort setting for VRT control	2.	8	2	Eco <b>Mild</b> Quick Powerful			0 1 2 3
89	Optional setting to prioritize VRT control	If indoor units are located throughout multiple spaces with different set points, it is recommended to keep this setting to 0. If all indoor units are located in the same space, the setting of 2 saves energy.	2.	8	9	<b>Prioritize largest demand</b> Prioritize smallest demand			0 2

No. *1	Item	Description	7 segment display			Description	7 segment display		
			Range				Range		
			SEG 1	SEG 2	SEG 3		SEG 1	SEG 2	SEG 3
90	Indoor unit without power	Multi-tenant function setting	2.	9	0	<b>Invalid</b> Valid (No U4 error generation) Valid (Operating with U4 warning)			<b>0</b> 1 2
92	Te target temperature upper limit	Used to make setting of targeted evaporating temperature upper limit for cooling and heat recovery operation.	2.	9	2	L M H			0 1 2
97	Auxiliary heater maximum allowable temperature	Auxiliary heater is allowed to energize when the ambient temperature is smaller than the auxiliary heater maximum allowable temperature.	2.	9	7	-17.7°C (0°F) -15°C (5°F) -12.2°C (10°F) -9.4°C (15°F) -6.6°C (20°F) -3.8°C (25°F) -1.1°C (30°F) <b>1.6°C (35°F)</b> 4.4°C (40°F) 7.2°C (45°F) 10°C (50°F) 12.7°C (55°F) 15.5°C (60°F) 18.3°C (65°F) Auxiliary heater always not allowed Auxiliary heater always allowed			0 1 2 3 4 5 6 7 8 9 0 1 1 2 3 4 5
98	Auxiliary heater maximum allowable temperature release differential	Auxiliary heater is not allowed to energize when the outdoor air temperature is recovered by differential above the auxiliary heater maximum allowable temperature.	2.	9	8	2.8°C (5°F) <b>5.6°C (10°F)</b> 8.3°C (15°F)			0 1 2

- \*1: Numbers in the **No.** column represent the number of times to press the BS button.
- \* : Setting does not return to factory setting when exit mode 2. To cancel the function, change setting manually to factory setting.
- \* : Once function is activated **t01** appears. To stop current function, press once the **RETURN (BS3)** button. For detailed description about each setting, refer to **Details of Setting Mode 2** on page 253.  
Indication **bold** means factory setting.

## 2.5.3 Details of Setting Mode 2

Mode 2 is used to change the field settings of the system. Consulting the current field setting value and changing the current field setting value is possible.

In general, normal operation can be resumed without special intervention after changing field settings.

Some field settings are used for special operation (e.g. 1 time operation, recovery/vacuumping setting, adding refrigerant setting, etc.). In such a case, it is required to abort the special operation before normal operation can restart. It will be displayed in below explanations.

- [2-0]: Cool/Heat selection setting  
Cool/Heat selection setting is used in case the optional Cool/Heat selector (KRC19-26A) is used. Depending on the outdoor unit setup (single outdoor unit setup or multi outdoor unit setup), the correct setting should be chosen. More details on how to use the Cool/Heat selector option can be found in the manual of the Cool/Heat selector. Default value: 0.
- 0: Each individual outdoor unit can select Cool/Heat operation (by Cool/Heat selector if installed).
  - 1: Master unit decides Cool/Heat operation when outdoor units are connected in multiple system combination
  - 2: Sub unit for Cool/Heat operation when outdoor units are connected in multiple system combination
- Change [2-0] to 0, 1 or 2 in function of required functionality.
- [2-2]: Low noise/demand address  
Address for low noise/demand operation.  
1 or more systems (maximum 10 systems wired by F1F2 OUT/D) can operate use the LNO (Low Noise Operation) or/and the DE (Demand Operation) by instruction of field supplied input to optional PCB DTA104A62.  
To link the system to the corresponding DTA104A62, set the address same as the DIP switches position on the related optional PCB DTA104A62.  
Ensure that also field setting 2-12-1 is set to enable input from optional PCB DTA104A62.
- [2-5]: Cross wiring check  
Default value: 0. Not active.  
Set 1: force all connected indoor units to operate the indoor fan on high speed. This setting can be made to check which units are missing in the communication if the number of indoor units do not correspond to the system lay out. Ensure that after cross wiring check was confirmed, to return setting to default 2-5-0. Once setting 2-5-1 is active, it is not automatically returning to default when exit mode 2.
- [2-6]: Forced thermostat ON command all connected indoor units  
Default value: 0. Not active.  
Set 1: force all connected indoor units to operate under test (forced thermostat ON command to outdoor). Ensure that when the forced thermostat ON needs to be ended, to return setting to default 2-6-0. Once setting 2-6-1 is active, it is not automatically returning to default when exit mode 2.



- [2-7]: Eco level setting for eco mode via external control adaptor.  
Eco mode can be activated by short circuit the terminal on external control adaptor (optional) according to [2-7] setting. ([2-64] should be 0)  
This unit can operate with Te or Tc fix control and eco mode. Eco mode means VRT control.  
If the terminal on external control adapter is not connected by short circuit with [2-7] ≠ 0, the system operates according to [2-8] or [2-9] setting.  
Default value: 0

Value [2-7]	Meaning	Level
0 (default)	Inactive	—
1	Eco mode active by low noise terminal short-circuit	Standard
2	Eco mode activate by demand terminal short-circuit	2-C short circuit: Low 3-C short circuit: Standard

- [2-8]: Te target temperature during cooling operation  
Default value: 2

Value [2-8]	Te target
0	Auto
2 (default)	6°C (42.8°F)
3	7°C (44.6°F)
4	8°C (46.4°F)
5	9°C (48.2°F)
6	10°C (50.0°F)
7	11°C (51.8°F)

- Change [2-8] to 0, 2-7 in function of required operation method during cooling.  
For more information and advice about the effect of these settings, see **Energy Saving and Optimum Operation** on page 276.

- [2-9]: Tc target temperature during heating operation  
Default value: 6

Value [2-9]	Tc target
0	Auto
1	41°C (105.8°F)
3	43°C (109.4°F)
6 (default)	46°C (114.8°F)

- Change [2-9] to 0, 1, 3 or 6 in function of required operation method during heating.  
For more information and advice about the effect of these settings, see **Energy Saving and Optimum Operation** on page 276.

- [2-10]: The heating capacity cut offset temperature setting.  
Sets the difference from the set temperature at which the heating capacity is cut.  
Default value: 0

Value [2-10]	Description
0 (default)	Set temperature +2.0°C (3.6°F)
1	Set temperature +1.0°C (1.8°F)
2	Set temperature +0.5°C (0.9°F)

- [2-12]: Enable the night-time low noise function and/or power consumption limitation via external control adaptor (DTA104A62)  
If the system needs to run under night-time low noise operation or under power consumption limitation conditions when an external signal is sent to the unit, this setting should be changed. This setting will only be effective when the optional external control adaptor (DTA104A62) is installed.

Default value: 0

To activate this function, change [2-12] to 1.

- [2-13]: AIRNET address  
When an AIRNET system will be used, outdoor unit needs an AIRNET address. Also to facilitate the recognition of a system in the map lay out of the service checker type III, set each system a unique address between 1 and 63.  
When duplicating of AIRNET address, **UC** error code will appear on central control.

- [2-18]: Fan high static pressure setting  
In order to increase the static pressure the outdoor fan is delivering, this setting should be activated. For details about this setting, see technical specifications.

Default value: 0

To activate this function, change [2-18] to 1.

- [2-19]: Phased installation setting  
Default value: 0

Value [2-19]	Description
0 (default)	OFF (Normal installation)
1	ON (Single module to dual module installation)

Conditions/rules apply for this setting. Refer to selection software or contact your Daikin sales representative for further details.

- [2-20]: Additional refrigerant charge or wrong wiring automatic detection  
In order to activate the additional refrigerant charge function or wrong wiring automatic detection, following setting should be applied.

Default value: 0

To activate additional refrigerant charge function, change [2-20] to 1.

To stop the additional refrigerant charge operation (when the required additional refrigerant amount is charged), press the **RETURN (BS3)** button. If this function was not aborted by pressing the **RETURN (BS3)** button, the unit will stop its operation after 30 minutes.

If 30 minutes was not sufficient to add the needed refrigerant amount, the function can be reactivated by changing the field setting again.

To activate wrong wiring automatic detection, change [2-20] to 2.

To stop the wrong wiring automatic detection, push **RETURN (BS3)**. If this function was not aborted by pushing **RETURN (BS3)**, the unit will stop its operation after 30-90 minutes. The operation time will depend on the number of connected indoor units. If wrong wiring is detected after operation, the outdoor unit and corresponding indoor unit display the error code **UF-01** while the other indoor units display the error code **U9**.

**oH** is displayed if no wrong wiring is detected. (Press the **RETURN (BS3)** button to finish.)

If operation stops and the outdoor unit displays **UF-18**, operation has been canceled to prevent failure of the compressor due to wrong wiring. The indoor unit with wrong wiring identified before the cancellation displays the error code **UF** while the other indoor units display the error code **U9**. Check and correct the wiring and then restart operation.

This function can be used when the outdoor temperature is between  $-5^{\circ}\text{C}$  and  $43^{\circ}\text{C}$  ( $23^{\circ}\text{F}$  and  $109^{\circ}\text{F}$ ) and the indoor temperature is between  $20^{\circ}\text{C}$  and  $27^{\circ}\text{C}$  ( $68^{\circ}\text{F}$  and  $81^{\circ}\text{F}$ ).

If the indoor temperature is outside the above range, either cooling or heating is automatically started to bring the indoor temperature to the suitable temperature. If the outdoor temperature is outside the above range or the indoor temperature is outside the above range even after cooling or heating, the error code **E-2** or **E-3** is displayed, and the function cannot be used.

If **E-4** appears during operation, there may be wrong wiring between indoor units that are largely different in capacity from each other or the additional refrigerant amount may be insufficient. Check the wiring of indoor units and confirm that the additional refrigerant amount has been calculated correctly.

This function can be used after test operation.

Error code during using this function and troubleshooting:

Error code	Cause	Troubleshooting
<b>E-2</b>	Indoor temperature is out of operating range.	Conduct cooling or heating operation to keep the indoor temperature within the operating range.
<b>E-3</b>	Outdoor temperature is out of operating range.	This function cannot be used.
<b>E-4</b>	The high pressure does not rise above a predetermined value or the low pressure does not fall below a predetermined value.	Check the wiring of indoor units and confirm the additional refrigerant amount.
<b>E-5</b>	The number of connected indoor units is one, or an error is occurring in one of the indoor units.	Take measures for the indoor unit in which the abnormality is occurring.
<b>UF-01</b>	Detected wrong wiring after this function.	Check the wiring of indoor units where <b>UF</b> error occurring.
<b>UF-18</b>	Detected wrong wiring with cancelled this function. (Due to compressor protection)	Check the wiring of indoor units where <b>UF</b> error occurring.

- [2-21]: Refrigerant recovery/vacuuming mode  
In order to achieve a free pathway to recovering refrigerant out of the system or to remove residual substances or to vacuum the system it is necessary to apply a setting which will open required valves in the refrigerant circuit so the recovering of refrigerant or vacuuming process can be done properly.

Default value: 0

To activate this function, change [2-21] to 1.

To stop the refrigerant recovery/vacuuming mode, press the **RETURN (BS3)** button. If the **RETURN (BS3)** button is not pressed, the system will remain in refrigerant recovery/vacuuming mode.

- [2-22]: Automatic night-time low noise setting and level during night-time  
By changing this setting, you can activate the automatic night-time low noise operation function of the unit and define the level of operation. Depending on the chosen level, the noise level will be lowered (3: Level 3 < 2: Level 2 < 1: Level 1). The start and stop moments for this function are defined under setting [2-26] and [2-27].

Default value: 0

Change [2-22] to 1, 2 or 3 in function of required level.

- [2-25]: Night-time low noise operation level via the external control adaptor  
If the system needs to run under night-time low noise operation conditions when an external signal is sent to the unit, this setting defines the level of night-time low noise that will be applied (3: Level 3 < 2: Level 2 < 1: Level 1). This setting will only be effective when the optional external control adaptor (DTA104A62) is installed and the setting [2-12] is activated.

Default value: 2

Change [2-25] to 1, 2 or 3 in function of required level.

- [2-26]: Night-time low noise operation start time  
Change [2-26] to 1, 2 or 3 in function of required timing.  
Default value: 2

Value [2-26]	Start time automatic night-time low noise operation (approximately)
1	About 8:00 PM
2 (default)	About 10:00 PM
3	About 12:00 AM

This setting is used in conjunction with setting [2-22].

- [2-27]: Night-time low noise operation stop time  
Default value: 3

Value [2-27]	Stop time automatic night-time low noise operation (approximately)
1	About 6:00 AM
2	About 7:00 AM
3 (default)	About 8:00 AM

This setting is used in conjunction with setting [2-22].

- [2-28]: Power transistor check mode  
To evaluate the output of the power transistors. Use this function in case error code is displayed related to defective inverter PCB or compressor is locked.  
Default value: 0. Power transistor check mode is not active.  
Field setting 1: Power transistor check mode is active.
- Function:**
- Inverter PCB gives output of 10 Hz in sequence by all 6 transistors. Remove the U/V/W terminals of the compressor, and connect to the inverter checker module. If all 6 LEDs blink, the transistors switch correctly.
  - When the power transistor check mode is interrupted, after internal power circuit is disconnected on the inverter PCB, 2 LEDs will light up to indicate discharge of the DC voltage. Wait till the LEDs are OFF before returning fasten terminals back to the compressor terminals.
- Minimum requirements to refer to the result on the inverter checker module:**
- All 3 phases and neutral are available, and
  - Inverter PCB control is active. Check if the green LED HAP on the inverter PCBs are blinking normal (approx. 1/second). If LEDs are OFF, need to exit the “standby mode” of the inverter:
    - Disconnect and reconnect power supply control PCB, or
    - Forced thermostat ON condition, or
    - Briefly set 2-6-1 (forced thermostat ON indoor), or 2-20-1 (manual refrigerant charge).
  - Once the LED is blinking on the inverter PCB, change related setting immediately back to set 0 to deactivate related function.
  - Diode module generates the required 260 VDC for REYQ-AATJ\* or 600 VDC for REYQ-AAJD\*.
- Cautions:**
- In case there is more than 1 compressor in a system (outdoor is multi outdoor configuration), all compressor inverter PCBs will perform the power transistor check. In such case, disconnect U/V/W fasten terminals on all compressors. Avoid accidental touch of fasten terminals to short circuit or ground leak to casing.
  - To stop the power transistor check mode, change setting to default 2-28-0.
  - Output to U/V/W will also stop when outdoor unit main PCB decides standby mode of inverter circuit.

Next time graph shows the different steps during the power transistor check mode.

■ Switching sequence during power transistor check mode:

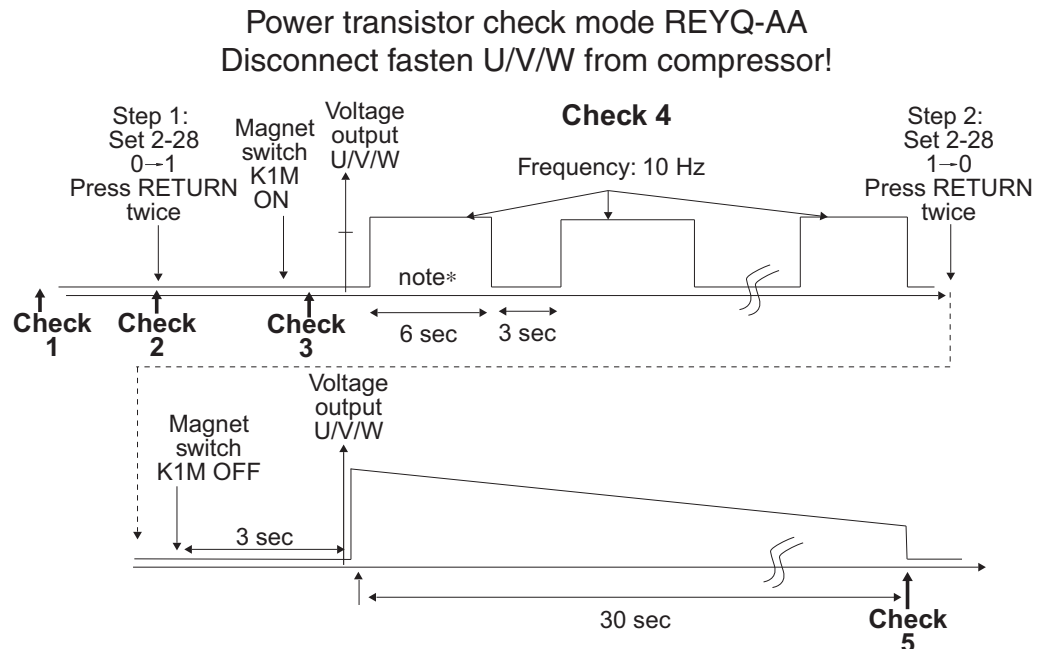

- Check 1** : AC power input:  
at terminal L1B, L2B, L3B for REYQ-AATJ\* (208/230 V unbalance maximum 2%).  
at terminal L1B, L2B, L3B for REYQ-AAYD\* (460 V unbalance maximum 2%).
- Check 2** : DC voltage:  
at connector X3A increases to  $\pm 260$  VDC for REYQ72AATJ\*.  
at connector X3A and X4A increases to  $\pm 260$  VDC for REYQ96-240AATJ\*.  
at connector X3A increases to  $\pm 600$  VDC for REYQ72AAYD\*.  
at connector X3A and X4A increases to  $\pm 600$  VDC for REYQ96-240AAYD\*.
- Check 3** : DC =  $1.42 \times$  VAC power supply:  
at connector X3A for REYQ72AATJ\*.  
at connector X3A and X4A for REYQ96-240AATJ\*.  
at connector X3A for REYQ72AAYD\*.  
at connector X3A and X4A for REYQ96-240AAYD\*.
- Check 4** : AC U/V/W 10 Hz intermediate:  
check difference within 10 V (at fasten U/V/W)
- Check 5** : Voltage drop (discharge capacitors DC)  
at connector X3A increases to  $\pm 260$  VDC for REYQ72AATJ\*.  
at connector X3A and X4A increases to  $\pm 260$  VDC for REYQ96-240AATJ\*.  
at connector X3A increases to  $\pm 600$  VDC for REYQ72AAYD\*.  
at connector X3A and X4A increases to  $\pm 600$  VDC for REYQ96-240AAYD\*.



**Note(s)**

Actual voltage value depends on multimeter characteristics:  
\*  $\pm 57$  VAC for REYQ-AATJ\* and  $\pm 115$  VAC for REYQ-AAYD\*.

- [2-29]: Intermittent fan operation  
Used for intermittent fan operation to assist snow discharge on outdoor fan.  
Default value: 0.

Value [2-29]	Intermittent fan operation
0 (default)	OFF
1	30 minutes OFF, 1 minute ON with medium fan speed
2	30 minutes OFF, 1 minute ON with high fan speed
3	15 minutes OFF, 1 minute ON with medium fan speed
4	15 minutes OFF, 1 minute ON with high fan speed
5	5 minutes OFF, 1 minute ON with medium fan speed
6	5 minutes OFF, 1 minute ON with high fan speed
7	Continuously ON with medium fan speed

- [2-30]: Power consumption limitation level (step 1) via the external control adaptor (DTA104A62)  
If the system needs to run under power consumption limitation conditions when an external signal is sent to the unit, this setting defines the level power consumption limitation that will be applied for step 1. The level is according to the table.

Default value: 3

Change [2-30]: 1, 2, 3, 4, 5, 6, 7, or 8 in function of required limitation

Value [2-30]	Power consumption limitation (Approximate)
1	60%
2	65%
3 (default)	70%
4	75%
5	80%
6	85%
7	90%
8	95%

- [2-31]: Power consumption limitation level (step 2) via the external control adaptor (DTA104A62)  
If the system needs to run under power consumption limitation conditions when an external signal is sent to the unit, this setting defines the level power consumption limitation that will be applied for step 2. The level is according to the table.

Default value: 1

Change [2-31] to 1, 2 or 3 in function of required limitation.

Value [2-31]	Power consumption limitation (approximately)
1 (default)	40%
2	50%
3	55%

- [2-32]: Forced, all time, power consumption limitation operation (no external control adaptor is required to perform power consumption limitation)  
If the system always needs to run under power consumption limitation conditions, this setting activates and defines the level power consumption limitation that will be applied continuously. The level is according to the table.

Default value: 0 (OFF).

Value [2-32]	Restriction reference
0 (default)	Function not active
1	Follows [2-30] setting
2	Follows [2-31] setting

Change [2-32]: 0, 1 or 2 in function of required limitation.

- [2-34]: Indoor fan tap setting  
Indoor units fan speed limitation related to connection capacity and outdoor air temperature for energy saving

Value [2-34]	Indoor fan tap setting
0 (default)	Fan speed is limited to L tap when indoor units capacity $\geq$ 130%.
1	In heating mode, fan speed is limited to L tap when indoor units capacity $\geq$ 130%.
2	Fan speed follows the setting of remote controllers (not limited by indoor units connection capacity).
3	Limited in cooling when $T_a < 29.5^\circ\text{C}$ (85.1°F) and Indoor condition is in condition A (*1) Returned when $T_a > 32.5^\circ\text{C}$ (90.5°F) or Indoor condition is in condition B (*2)
4	Limited in cooling when $T_a < 23.5^\circ\text{C}$ (74.3°F) and Indoor condition is in condition A (*1) Returned when $T_a > 26.5^\circ\text{C}$ (79.7°F) or Indoor condition is in condition B (*2)
5	Limited in cooling when $T_a < 19.3^\circ\text{C}$ (66.7°F) and Indoor condition is in condition A (*1) Returned when $T_a > 22.3^\circ\text{C}$ (72.1°F) or Indoor condition is in condition B (*2)
6	Limited in cooling when $T_a < 29.5^\circ\text{C}$ (85.1°F) Returned when $T_a > 32.5^\circ\text{C}$ (90.5°F)
7	Limited in cooling when $T_a < 23.5^\circ\text{C}$ (74.3°F) Returned when $T_a > 26.5^\circ\text{C}$ (79.7°F)
8	Limited in cooling when $T_a < 19.3^\circ\text{C}$ (66.7°F) Returned when $T_a > 22.3^\circ\text{C}$ (72.1°F)



### Note(s)

\*1. Indoor condition A: Temperature difference Average of (indoor air temperature – set temperature) is less than  $1.5^\circ\text{C}$  (2.7°F).

\*2. Indoor condition B: Temperature difference Average of (indoor air temperature – set temperature) is  $3^\circ\text{C}$  (5.4°F) or more.

- [2-35]: Height difference setting  
Default value: 1

In case the outdoor unit is installed in the lowest position (indoor units are installed on a higher position than outdoor units) and the height difference between the highest indoor unit and the outdoor unit exceeds 40 m (130 ft), the setting [2-35] should be changed to 0.

If the setting [2-35] is changed to 0, continuous heating will not be provided during defrost of oil return for conditions above ambient temp.  $10^\circ\text{C}$  (50°F) and room temp.  $24^\circ\text{C}$  (75°F).



- [2-38]: Emergency operation Master  
To disable compressor operation permanently: in case of single module or Master unit of a multi outdoor system, this setting allows:  
Default value: 0. Compressor operation enabled.  
Field setting:  
  - Set 1: Master INV. 1 is disabled permanently.
  - Set 2: Master INV. 2 is disabled permanently
  - Set 3: Master module is disabled permanently.
- [2-39]: Emergency operation Sub  
To disable compressor operation of Sub unit of a multi outdoor system permanently:  
Default value: 0. Compressor operation enabled.  
Field setting:  
  - Set 1: Sub INV. 1 is disabled permanently.
  - Set 2: Sub INV. 2 is disabled permanently
  - Set 3: Sub module is disabled permanently.
- [2-42]: Outdoor fan noise countermeasure  
Change fans rotational speed and reduce noise by the interference of air blow noise between outdoor units.  
Default value: 0  
Field setting:  
  - Mode A: 1
  - Mode B: 2
- [2-45]: Low ambient cooling  
  
Default value: 0.

[2-45]	Description
0 (default)	No low ambient cooling available.
1	Low ambient cooling available.

This setting is not applicable to BS-Q54TVJ models.

- [2-47]: Te target temperature during heat recovery operation  
Default value: 2.

Value [2-47]	Te target
0	Auto
2 (default)	6°C (42.8°F)
3	7°C (44.6°F)
4	8°C (46.4°F)
5	9°C (48.2°F)
6	10°C (50.0°F)
7	11°C (51.8°F)

Change [2-47] to 0, 2-7 in function of required operation method during heat recovery operation. For more information and advice about the effect of these settings, see **Energy Saving and Optimum Operation** on page 276.

## [2-49]: Height difference setting

Default value: 0.

In case the outdoor unit is installed in the highest position (indoor units are installed on a lower position than outdoor units) and the height difference between the lowest indoor unit and the outdoor unit exceeds 50 m (164 ft), the setting [2-49] has to be changed to 1.

## [2-51]: Master/Sub setting Multi

When 2 modules are installed as a multi-outdoor (by common refrigerant piping and wiring by terminals Q1Q2) configuration is automatically detected. In certain cases, the sequence of the Sub unit need to be set manually (in case of AIRNET monitoring).

Default value: 0. Automatic detection.

Field setting: ensure that the modules in a multi are set different status. Even some modules in a multi are set manually to same status, U7 error will appear.

- 1: forced Master (F1F2/Ind terminals should be connected to indoor units).
- 2: forced Sub (only Q1Q2 terminals should be wired to Master module).

## [2-60]: Gas furnace setting

Default value: 0.

When a gas furnace is connected, the setting [2-60] has to be changed to 1.

## [2-62]: Cooling and heating capacity learning control

Default value: 0.

Value [2-62]	Description
0 (default)	OFF
1	Cooling adjustment
2	Heating adjustment
3	Cooling and heating adjustment

Adjust cooling and heating system operation to achieve stable capacity.

**Note(s)**

This setting may result in a longer reaction time to large load variations.

## [2-64]: Eco mode invalid setting

Used to make setting of Eco mode invalid. When this configuration is set, it is not possible to turn Eco mode ON/OFF using external control adaptor or other setting.

Default value: 0.

Value [2-64]	Eco mode control setting
0 (default)	Activated both cooling and heating
1	Activated heating only
2	Activated cooling only
3	Deactivated

## [2-71]: Branch selector switching time

Default value: 0.

Used for changing branch selector switching time.

\*All piping length between branch selector unit and indoor units should be less than 9.7 m (32 ft).

[2-81]: Cooling comfort setting for VRT control

Default value: 1

Value [2-81]	Cooling comfort setting
0	Eco
1 (default)	Mild
2	Quick
3	Powerful

Change [2-81] to 0, 1, 2 or 3 in function of required limitation.

This setting is used in conjunction with setting [2-8] and [2-47].

In the case [2-81] is 0, the original refrigerant temperature target based on [2-8] and [2-47] is kept without any correction, unless for protection control.

For more information and advice about the effect of these settings, refer to **Energy Saving and Optimum Operation** on page 276.

[2-82]: Heating comfort setting for VRT control

Default value: 1.

Value [2-82]	Heating comfort setting
0	Eco
1 (default)	Mild
2	Quick
3	Powerful

Change [2-82] to 0, 1, 2 or 3 in function of required limitation.

This setting is used in conjunction with setting [2-9].

In the case [2-82] is 0, the original refrigerant temperature target based on [2-9] is kept without any correction, unless for protection control.

For more information and advice about the effect of these settings, refer to **Energy Saving and Optimum Operation** on page 276.

[2-89]: Optional setting to prioritize VRT control

Default value: 0.

Value [2-89]	Level
0 (default)	Prioritize largest demand
2	Prioritize smallest demand



**Note(s)**

Setting [2-89] to 2 saves energy, but the time to reach the set point may be longer.

- [2-90]: Indoor unit without power  
**U4** error generation.  
 In case an indoor unit needs maintenance or repair on the electric side, it is possible to keep the rest of the **VRV** DX indoor units operating without power supply to some indoor unit(s).  
 Default value: 0 (not active)  
 Field setting 1: It is possible to operate system without **U4** error when some indoor units are temporarily without power supply.  
 Field setting 2: It is possible to operate system with **U4** warning when some indoor units are temporarily without power supply.  
 Following conditions need to fulfil:
- Maximum equivalent piping length of the farthest indoor less than 120 m (394 ft).
  - Index indoor units power simultaneously less than 30% of the nominal outdoor.
  - Total capacity is less than 30% of the nominal one of the outdoor unit.
  - Operation time is limited to 24 hours period.
  - It is recommended to shut down connected indoor units at the same floor.
  - Not possible to use service mode operation (e.g. recovery mode).
  - Backup operation has priority over this special feature.

- [2-92]: Te target temperature upper limit

Default value: 1.

Value [2-92]	Te target temperature upper limit
0	L
1 (default)	M
2	H

If Auto Te, then use this setting to address different load profiles. If the frequent operation is at lower system load, then use a higher setting under [2-92].



**Note(s)**

In high humid areas, it is recommended to keep this setting to 0 or 1.

## 2.5.4 Auxiliary Heat Control

To improve efficiency the auxiliary heat can be lockout based on outdoor temperature.

Item	Description	Min	Max	Increments
Auxiliary heater allowable temperature	Below this temperature, auxiliary heater can be energized based on the indoor temperature condition.	0°F (-17.7°C)	65°F (18.3°C) (Default 35°F (1.6°C))	5°F (2.8°C)
Auxiliary heater allowable temperature release differential	When the outdoor temperature recovered by this temperature, auxiliary heater cannot be allowed.	5°F, 10°F (default), 15°F (2.8°C, 5.6°C (default), 8.3°C)		

[2-97]: Auxiliary heater maximum allowable temperature  
Auxiliary heater is allowed to energize when the ambient temperature is smaller than the auxiliary heater maximum allowable temperature.

Auxiliary heater maximum allowable temperature	Fahrenheit (°F)	Celsius (°C)
0	0	-17.7
1	5	-15
2	10	-12.2
3	15	-9.4
4	20	-6.6
5	25	-3.8
6	30	-1.1
7 (default)	35	1.6
8	40	4.4
9	45	7.2
10	50	10
11	55	12.7
12	60	15.5
13	65	18.3
14	Auxiliary heater always NOT allowed	
15	Auxiliary heater always allowed	

[2-98]: Auxiliary heater maximum allowable temperature release differential  
Auxiliary heater is not allowed to energize when the outdoor air temperature is recovered by differential (below) above the auxiliary heater maximum allowable temperature.

Auxiliary heater max allowable temperature release differential	Fahrenheit (°F)	Celsius (°C)
0	5	2.8
1 (default)	10	5.6
2	15	8.3

## 2.5.5 Heat Pump Lockout

New control logic to provide more application options for cold climates.

Outside temperature can now be measured directly from the outdoor unit coil sensor.

This field setting can switch automatically to emergency heat if there is a system fault.

Item	Description	Min	Max	Increments
Heat pump lockout temperature	Below this temperature, heat pump is locked out.	-15°F (-26.1°C) (default)	50°F (10°C)	5°F (2.8°C)
Heat pump lockout release differential	When the outdoor air temperature is recovered by this temperature, heat pump is resumed.	5°F, 10°F (default), 15°F (2.8°C, 5.6°C (default), 8.3°C)		

[2-16]: Auxiliary heater setting (Type I)

Value [2-16]	Auxiliary heater
0 (default)	OFF
1	ON

[2-37]: Auxiliary heater setting (Type II)

Value [2-37]	Controlling mode
0 (default)	OFF
1	Mode 1
2	Mode 2
3	Mode 3
4	Mode 4
5	Mode 5
6	Mode 6

Type	Description	Actions						
		Field setting	Shorted between	Heating thermostat ON		Heating thermostat OFF		
				Auxiliary heater	Indoor fan	Auxiliary heater	Indoor fan	
I	—	Heat pump heating is always locked out	2-16: ON	—	ON	ON (H/L)	OFF	LL
II	Mode 1	Lockout is controlled by ABC terminals	2-37: Mode 1	A-C	ON	ON (H/L)	OFF	LL
	B-C			OFF				
	Mode 2 (for a heater which does not need airflow)	Lockout is controlled by the outdoor air temperature and setpoint which is configured by the field setting [2-78] and [2-79]	2-37: Mode 2	A-C	LL	OFF	LL	
	B-C			OFF				
Mode 3	2-37: Mode 3	Same as 2-37: Mode 1 & A-C shorted						
Mode 4	2-37: Mode 4	Same as 2-37: Mode 1 & B-C shorted						
Mode 5	2-37: Mode 5	Same as 2-37: Mode 2 & A-C shorted						
Mode 6	2-37: Mode 6	Same as 2-37: Mode 2 & B-C shorted						

- [2-78]: Heat pump lockout temperature  
 Heat pump would be locked out when the outdoor air temperature is smaller than the Heat Pump Lockout Temperature below – this setting is only affective when heat pump lockout mode has been set. Unit will switch to heat pump lockout.

Heat pump lockout temperature	Fahrenheit (°F)	Celsius (°C)
0 (default)	-15	-26.1
1	-10	-23.3
2	-5	-20.5
3	0	-17.7
4	5	-15
5	10	-12.2
6	15	-9.4
7	20	-6.6
8	25	-3.8
9	30	-1.1
10	35	1.6
11	40	4.4
12	45	7.2
13	50	10
14	Forced heat pump lockout	

- [2-79]: Heat pump lockout release differential  
Heat pump would be resumed when the outdoor air temperature is recovered by differential (below) above the heat pump lockout temperature.

Heat pump lockout release differential	Fahrenheit (°F)	Celsius (°C)
0	5	2.8
1 (default)	10	5.6
2	15	8.3

When heat pump lockout mode has been set the auto backup function will automatically be set. This will allow the auxiliary or secondary heat source to be automatically energized in the event of a system failure.

Error codes capable of auto backup are listed in the table below.

Please be aware that the error codes that are not listed do not auto backup in order to protect the unit.

Error contents	Error code (Auto backup possible)
Activation of high pressure switch	E3
Activation of low pressure sensor	E4
Compressor motor lock	E5
Compressor damage alarm	E6
Outdoor fan motor abnormality	E7
Electronic expansion valve coil abnormality	E9
Four way valve abnormality Opposite air conditioning alarm	EA
Box air thermistor abnormality	H1
Harness abnormality (between outdoor unit main PCB and inverter PCB)	H3
Outdoor fan PCB abnormality	H7
Outdoor air thermistor abnormality	H9
Discharge pipe temperature abnormality	F3
Wet alarm	F4
Branch Selector unit electronic expansion valve abnormality	F9
Discharge pipe thermistor abnormality Compressor body thermistor abnormality	J3
Compressor suction thermistor abnormality Suction pipe before accumulator thermistor abnormality	J5
Heat exchanger deicer thermistor abnormality Heat exchanger gas pipe thermistor abnormality	J6
Receiver inlet thermistor abnormality Subcooling heat exchanger liquid pipe thermistor abnormality Subcooling injection thermistor abnormality	J7
Heat exchanger liquid pipe thermistor abnormality	J8
Subcooling heat exchanger gas pipe thermistor abnormality Receiver gas purge thermistor abnormality Electrical box air outlet thermistor abnormality	J9
High pressure sensor abnormality	JA
Low pressure sensor abnormality	JC
Inverter PCB abnormality	L1
Inverter radiation fin temperature rise abnormality	L4
Compressor instantaneous overcurrent	L5
Compressor overcurrent	L8
Compressor startup abnormality	L9
Transmission error between inverter and outdoor unit main PCB	LC



## 2.6 Cool/Heat Mode Changeover

Set Cool/Heat Separately for Each Branch Selector Unit by Cool/Heat Selector.

Set remote controller changeover switch DS1-1 as following:

- ◆ Set the DIP switch (DS1-1) on printed circuit board (A1P) as shown below before turning on the power to the Branch Selector unit.

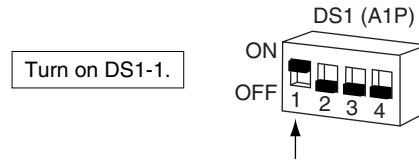

When using cool/heat selector, connect to the terminal A, B and C on the PCB of the electrical component box.

### EXAMPLE OF TRANSMISSION LINE CONNECTION

- ◆ Example of connecting transmission wiring.  
Connect the transmission wirings as shown in the figure below.

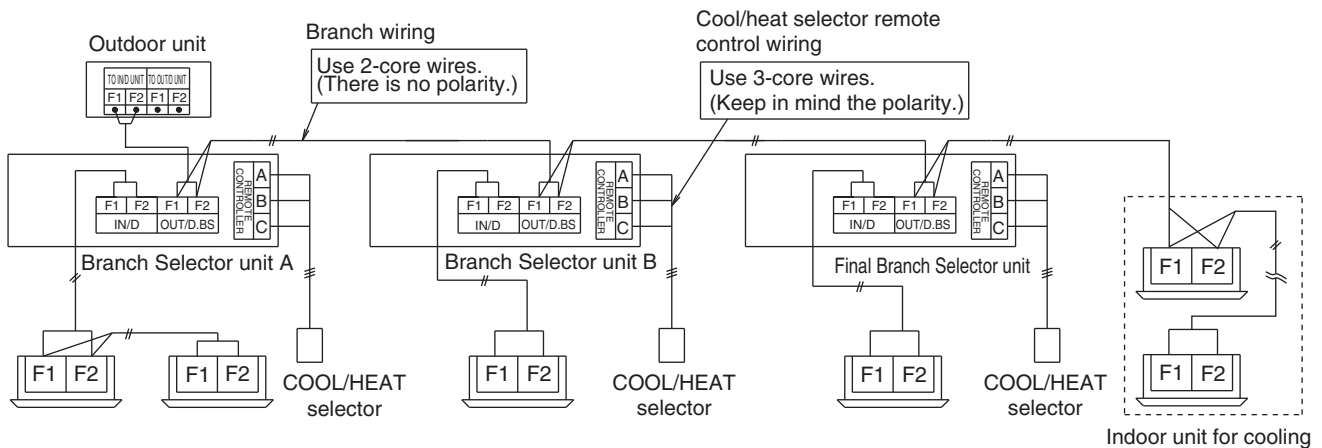
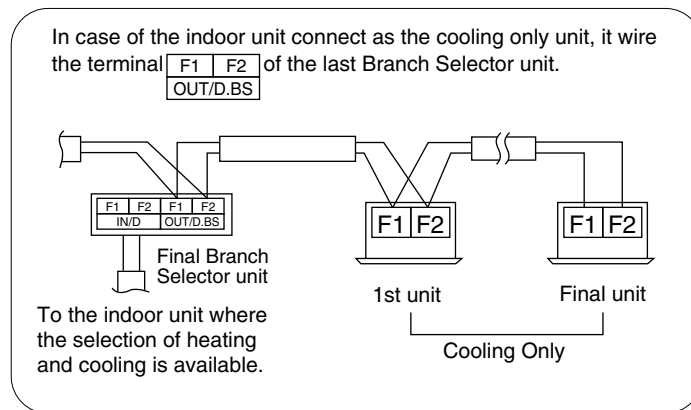

## 2.7 Night-Time Low Noise Operation and Demand Operation

### 2.7.1 Night-Time Low Noise Operation

By connecting the external contact input to the low noise input of the outdoor unit external control adaptor (optional), you can lower operating noise.

Setting	Content
Level 1	Set the outdoor fan to Step 6 or lower.
Level 2	Set the outdoor fan to Step 5 or lower.
Level 3	Set the outdoor fan to Step 4 or lower.

#### A. When night-time low noise operation is carried out by external contact (with the use of the external control adaptor for outdoor unit).

1. Connect external control adaptor for outdoor unit and short circuit terminal of night-time low noise operation (Refer below figure). If carrying out demand or low noise input, connect the adaptor's terminals as shown below.

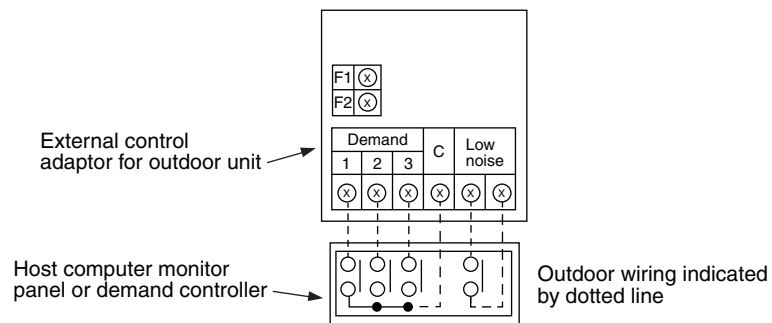

2. While in setting mode 2, set the item 2-12 (External low noise or demand setting) to ON.
3. If necessary, while in setting mode 2, select an external low noise level for the item 2-25.

#### B. When night-time low noise operation is carried out automatically. (External control adaptor for outdoor unit is not required.)

1. While in setting mode 2, select a night-time low noise operation level for the item 2-22.
2. If necessary, while in setting mode 2, select a starting time of night-time low noise operation (i.e., 8:00 PM, 10:00 PM, or 12:00 AM) for the item 2-26. (Use the starting time as a guide since it is estimated according to outdoor temperatures.)
3. If necessary, while in setting mode 2, select an ending time of night-time low noise operation (i.e., 6:00 AM, 7:00 AM, or 8:00 AM) for the item 2-27. (Use the ending time as a guide since it is estimated according to outdoor air temperatures.)

**Image of operation in the case of A**

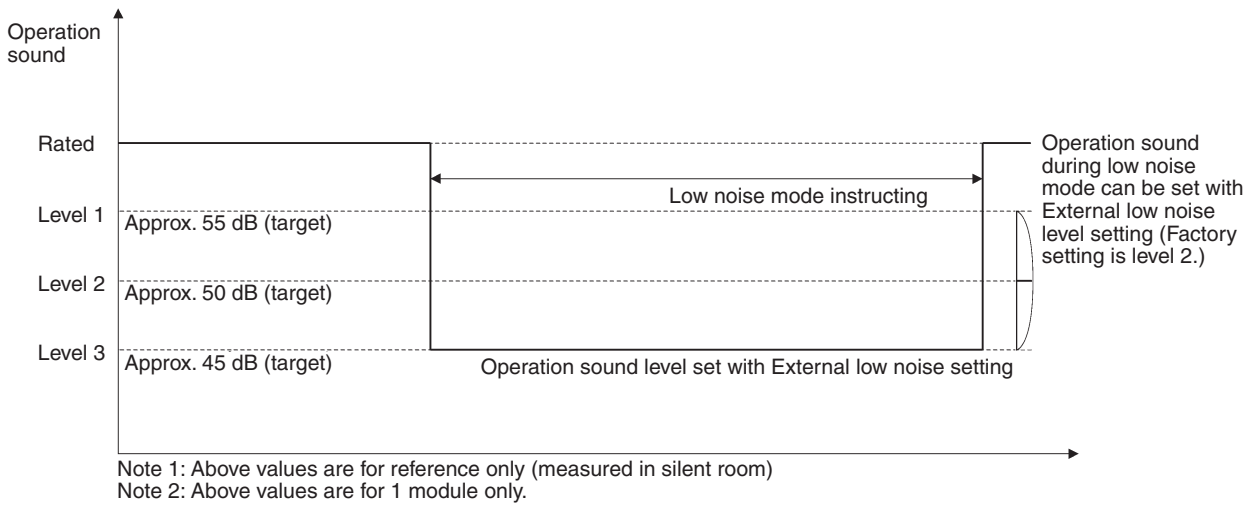

**Image of operation in the case of B**

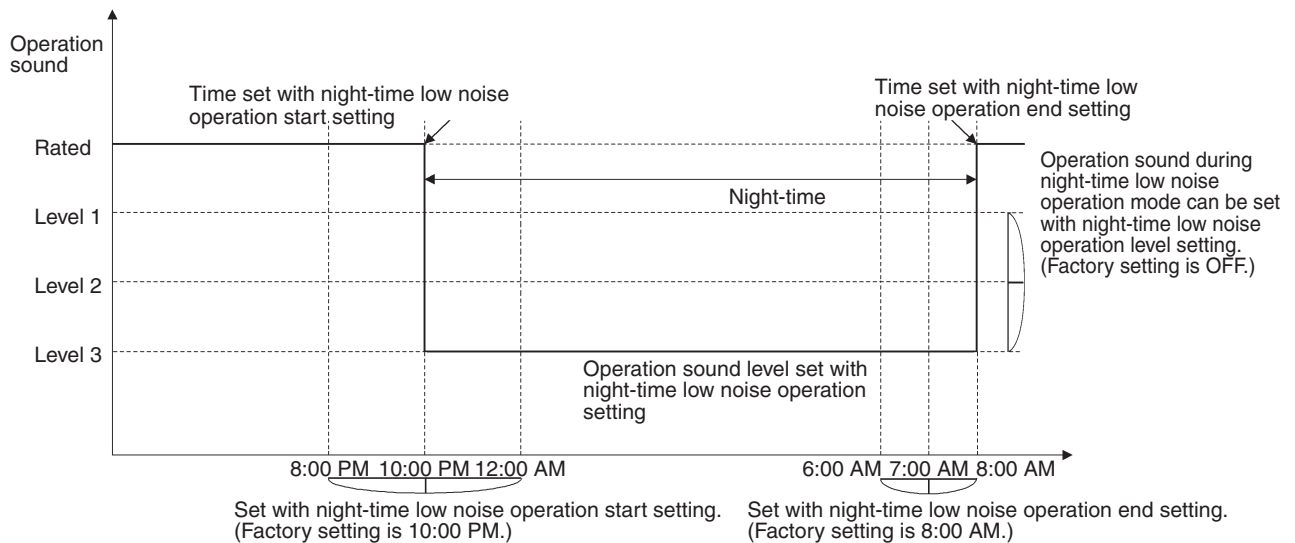

**Image of operation in the case of A and B**

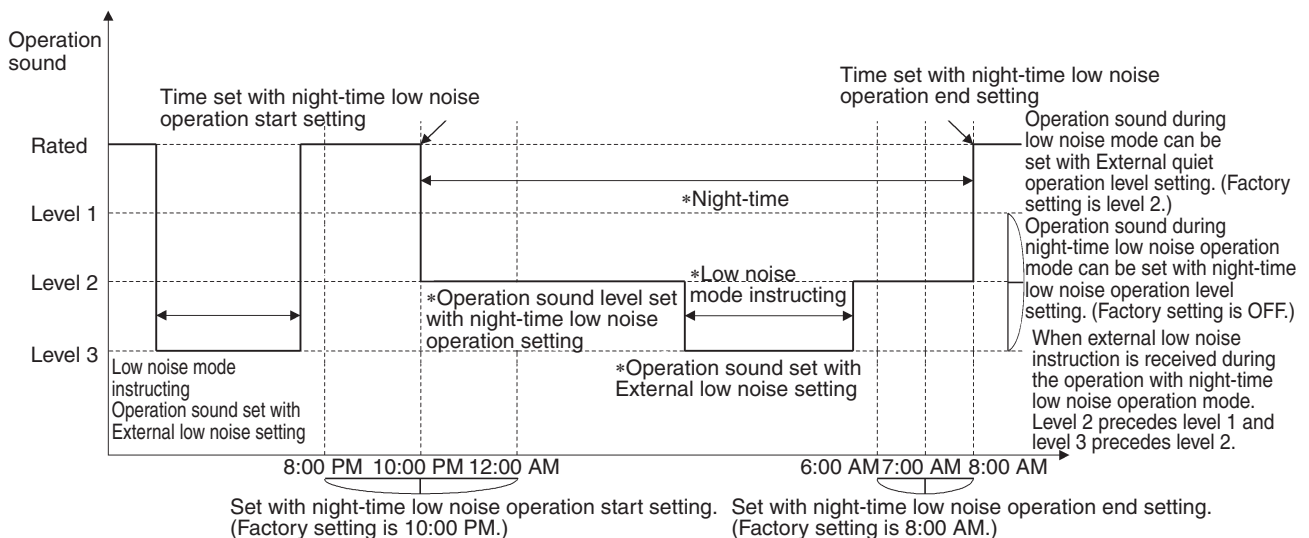

## 2.7.2 Demand Operation

By connecting the external contact input to the demand input of the outdoor unit external control adaptor for outdoor unit (optional), the power consumption of unit operation can be saved suppressing the compressor operating condition.

Description of setting		Setting procedure	
Setting item	Description	External control adaptor for outdoor unit	Outdoor unit PCB
Demand 1	Operate with power of 70% or less of the rating.	Short circuit between 1 and C of the terminal block (TeS1).	Set the item 2-32 to Demand 1.
Demand 2	Operate with power of 40% or less of the rating.	Short circuit between 2 and C.	Set the item 2-32 to Demand 2.
Demand 3	Operate with forced thermostat OFF.	Short circuit between 3 and C.	—

However, the demand operation does not occur in the following operation modes.

1. Startup control
2. Oil return operation
3. Defrost operation
4. Pump down residual operation

If carrying out demand or low noise input, connect the adaptor's terminals as shown below.

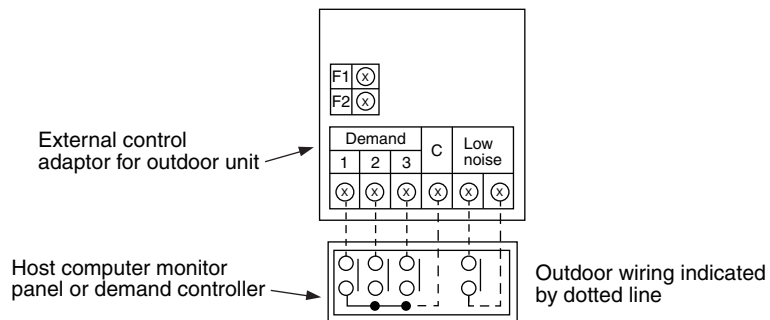

### A. When the demand operation is carried out by external contact (with the use of the external control adaptor for outdoor unit).

1. Connect external control adaptor for outdoor unit and short circuit terminals as required (Refer to the figure above).
2. While in setting mode 2, set the item 2-12 (External low noise or demand setting) to ON.
3. If necessary, while in setting mode 2, select a demand 1 level for the item 2-30.

### B. When the Normal demand operation is carried out. (Use of the external control adaptor for outdoor unit is not required.)

1. While in setting mode 2, set the item 2-32 (Setting of alternate demand) to ON.
2. While in setting mode 2, select a demand 1 level for the item 2-30.

If carrying out demand or low-noise input, connect the terminals of the external control adaptor for outdoor unit as shown below.

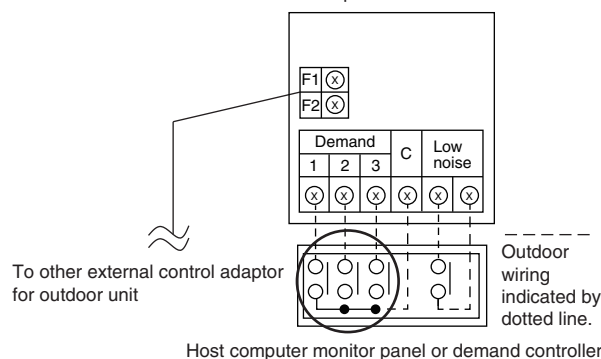

**Image of operation in the case of A**

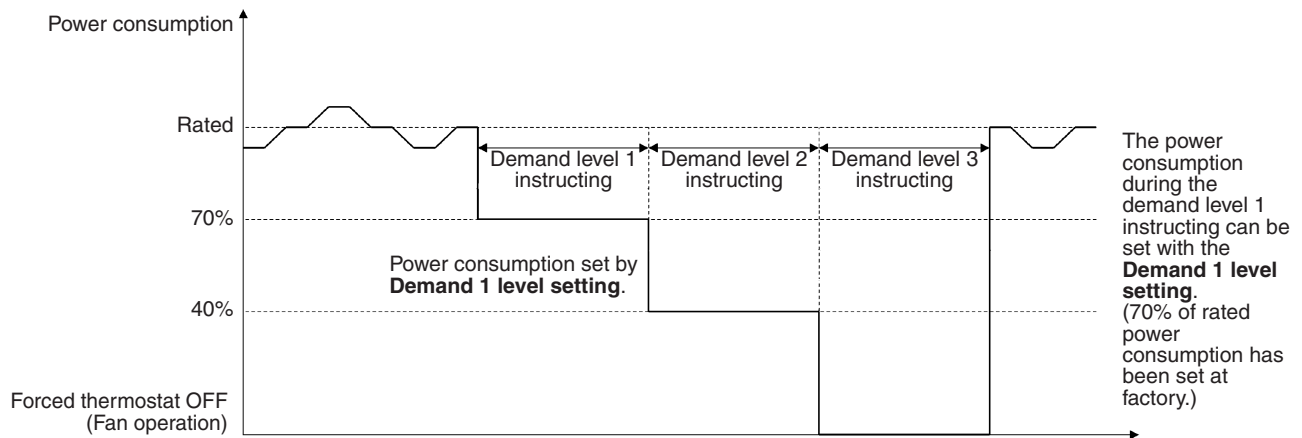

**Image of operation in the case of B**

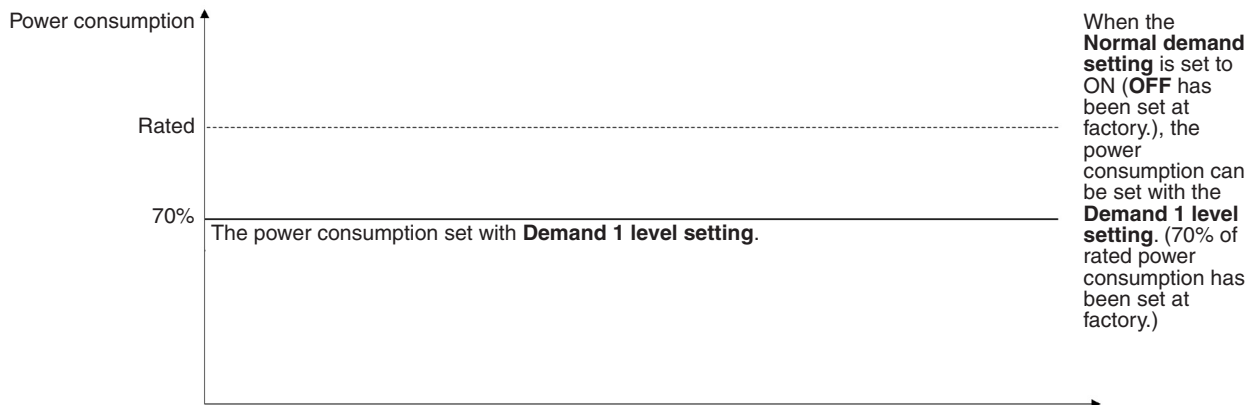

**Image of operation in the case of A and B**

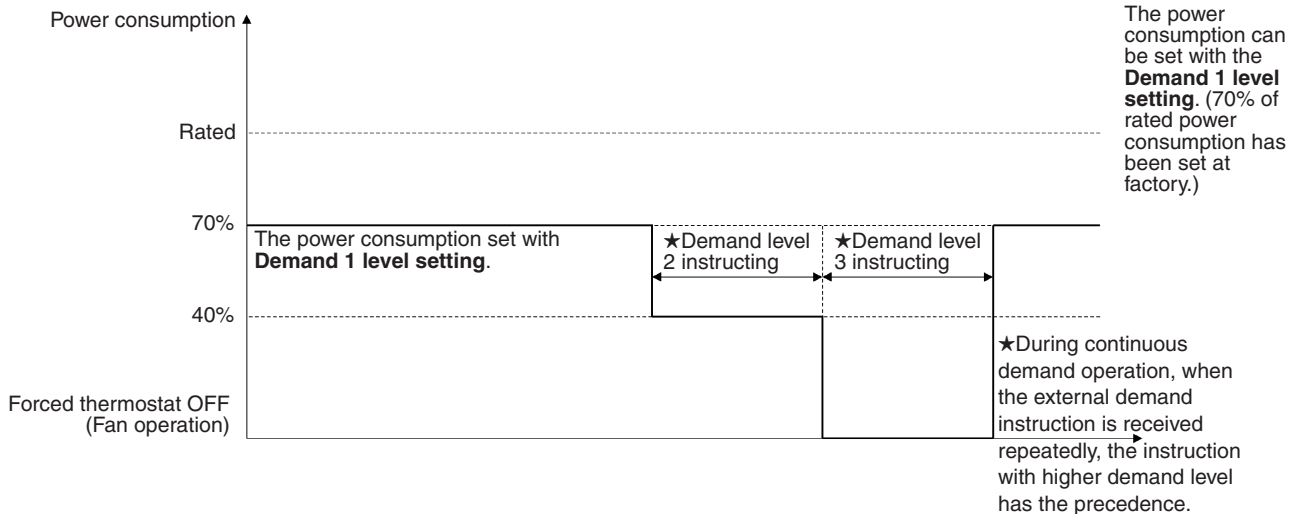

## 2.7.3 Setting Procedure of Night-Time Low Noise Operation and Demand Operation

### 1. Setting mode 1 (H1P OFF)

In setting mode 2, press the **MODE (BS1)** button once → Setting mode 1 is entered and H1P turns OFF. While the setting mode 1 is displayed, **In night-time low noise operation** and **In demand operation** are displayed.

### 2. Setting mode 2 (H1P ON)

1. In setting 1, press and hold the **MODE (BS1)** button for more than 5 seconds. → Setting mode 2 is entered and H1P lights.
2. Press the **SET (BS2)** button several times and match the LED display with the Setting No. you want.
3. Press the **RETURN (BS3)** button once, and the present setting content is displayed. → Press the **SET (BS2)** button several times and match the LED display with the setting content you want.
4. Press the **RETURN (BS3)** button two times. → Returns to (1).
5. Press the **MODE (BS1)** button once → Returns to the setting mode 1 and H1P turns OFF.

## 2.8 Energy Saving and Optimum Operation

This **VRV** heat recovery system is equipped with advanced energy saving functionality (VRT). Detecting all connected indoor unit type, advanced energy saving functionality type is selected automatically. Depending on the priority, emphasizes can be put on energy saving or comfort level. Several parameters can be selected, resulting in the optimal balance between energy consumption and comfort for the particular application.

Several patterns are available and explained below.

Modify the parameters to the needs of your building and to realize the best balance between energy consumption and comfort.

### 2.8.1 Target Temperature Settings

#### • Basic

The refrigerant temperature is fixed independent from the situation.

It corresponds to the standard operation which is known and can be expected from/under previous **VRV** systems:

- ◆ To activate this operation method under cooling operation: Change field setting [2-64] to 1 or disconnect the circuit between terminal on external control adaptor with [2-7] ≠ 0. And also change field setting [2-81] to 0.
- ◆ To activate this operation method under heating operation: Change field setting [2-64] to 2 or disconnect the circuit between terminal on external control adaptor with [2-7] ≠ 0. And also change field setting [2-82] to 0

#### • Automatic for VRT control

The refrigerant temperature is set depending on the outdoor air conditions. As such adjusting the refrigerant temperature to match the required load (which is also related to the outdoor air conditions).

E.g., when your system is operating in cooling, you do not need as much cooling under low outdoor air temperatures (e.g., 77°F (25°C)) as under high outdoor air temperatures (e.g., 95°F (35°C)). Using this idea, the system automatically starts increasing its refrigerant temperature, automatically reducing the delivered capacity and increasing the system's efficiency.

- ◆ This operation is selected automatically with checking connected indoor unit type.

E.g., when your system is operating in heating, you do not need as much heating under high outdoor air temperatures (e.g., 68°F (20°C)) as under low outdoor air temperatures (e.g., 23°F (-5°C)).

Using this idea, the system automatically starts decreasing its refrigerant temperature, automatically reducing the delivered capacity and increasing the system's efficiency.

- ◆ This operation is selected automatically with checking connected indoor unit type.

#### • Hi-sensible

The refrigerant temperature is set higher/lower (cooling/heating) compared to basic operation. The focus under high sensible mode is comfort feeling for the customer.

The selection method of indoor units is important and has to be considered as the available capacity is not the same as under basic operation. For details concerning to Hi-sensible applications, please contact your dealer.

- ◆ To activate this setting under cooling operation: change field setting [2-8] to the appropriate value, matching the requirements of the pre-designed system containing a high sensible solution.

Value [2-8]	Te target
3	45°F (7°C)
4	46°F (8°C)
5	48°F (9°C)
6	50°F (10°C)
7	52°F (11°C)

- ♦ To activate this setting under heating operation: change field setting [2-9] to the appropriate value, matching the requirements of the pre-designed system containing a high sensible solution.

Value [2-9]	Tc target
1	106°F (41°C)
3	109°F (43°C)

## 2.8.2 Comfort Settings

A comfort level can be set for VRT control mode and hi-sensible mode. The comfort level is related to the time and power (energy consumption) expended in order to achieve a certain room temperature. The requested conditions are achieved more quickly by temporarily changing the refrigerant temperature.

### • Powerful

Overshoot (during heating operation) or undershoot (during cooling operation) is allowed compare to the requested refrigerant temperature, in order to achieve the required room temperature very fast. The overshoot is allowed from the start up moment.

In case of cooling operation the evaporating temperature is allowed to go down to 37°F (3°C) on temporary base depending on the situation.

In case of heating operation the condense temperature is allowed to go up to 120°F (49°C) on temporary base depending on the situation.

When the request from the indoor units becomes more moderate, the system will eventually go to the steady state condition which is defined by the operation method above.

- ♦ To activate the powerful comfort setting under cooling operation, change field setting [2-81] to 3.
- ♦ To activate the powerful comfort setting under heating operation, change field setting [2-82] to 3.

### • Quick

Overshoot (during heating operation) or undershoot (during cooling operation) is allowed compared to the requested refrigerant temperature, in order to achieve the required room temperature very fast. The overshoot is allowed from the start up moment.

In case of cooling operation the evaporating temperature is allowed to go down to 43°F (6°C) on temporary base depending on the situation.

In case of heating operation the condense temperature is allowed to go up to 115°F (46°C) on temporary base depending on the situation.

When the request from the indoor units becomes more moderate, the system will eventually go to the steady state condition which is defined by the operation method above.

- ♦ To activate the quick comfort setting under cooling operation, change field setting [2-81] to 2.
- ♦ To activate the quick comfort setting under heating operation, change field setting [2-82] to 2.

### • Mild

Overshoot (during heating operation) or undershoot (during cooling operation) is allowed compared to the requested refrigerant temperature, in order to achieve the required room temperature very fast. The overshoot is not allowed from the start up moment.

The start up occurs under the condition which is defined by the operation mode above.

In case of cooling operation the evaporating temperature is allowed to go down to 43°F (6°C) on



temporary base depending on the situation.

In case of heating operation the condense temperature is allowed to go up to 115°F (46°C) on temporary base depending on the situation.

When the request from the indoor units becomes more moderate, the system will eventually go to the steady state condition which is defined by the operation method above.

The start up condition is different from the powerful and quick comfort setting.

- ◆ To activate the mild comfort setting under cooling operation, change field setting [2-81] to 1.
- ◆ To activate the mild comfort setting under heating operation, change field setting [2-82] to 1.

• **Eco**

The original refrigerant temperature target, which is defined by the operation method (see above) is kept without any correction, unless for protection control.

- ◆ To activate the eco comfort setting under cooling operation, change field setting [2-81] to 0.
- ◆ To activate the eco comfort setting under heating operation, change field setting [2-82] to 0.

No matter which control is selected, variations on the behavior of the system are still possible due to protection controls to keep the unit operating under reliable conditions. The intentional target, however, is fixed and will be used to obtain the best balance between energy consumption and comfort, depending on the application type.

## 3. Field Settings for Branch Selector Unit

### 3.1 Field Settings for Single Branch Selector Unit

Follow the instructions below to set the DIP switches as necessary.



#### Warning

Electric shock hazard! Before performing work, be sure to disconnect any power source connected to the unit.

#### 1. Setting for when connecting the COOL/HEAT SELECTOR to the Branch Selector unit.

##### Setting description

Set the input signal from the COOL/HEAT SELECTOR (sold separately) to ON/OFF.

##### Setting method

Set the dip switches (DS1-1) on PCB (A1P) as shown below before turning on the power to the Branch Selector unit.

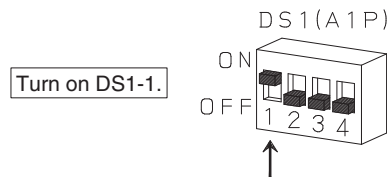

#### Note(s)

This setting is enabled when the Branch Selector unit power is turned on.

- ◆ Be sure to make the setting before turning on the power.
- ◆ Always close the control box cover after making the setting.

#### 2. Setting when changing the automatic mode differential in the Cooling/Heating Automatic Operation Mode.

##### Setting description

- ◆ The automatic mode differential can be changed within the range of 0°F (0°C) to 12.6°F (7°C) (0°F (0°C) at factory shipment).
- ◆ For details regarding the automatic mode differential and indoor unit operation, refer to page 187.

##### Setting method

The setting is made using the field setting mode by the remote controller of indoor unit connected to the Branch Selector unit.

For information regarding the setting method, refer to page 226.

## 3.2 Field Settings for Multi Branch Selector Unit (Standard Series)

Follow the instructions below to set the DIP switches as necessary.



**Warning**

Electric shock hazard! Before performing work, be sure to disconnect any power source connected to the unit.

**Procedure**

1. Disconnect the power source.
2. Set the DIP switches (DS1, DS2) for the corresponding branch ports based on the following table.
3. Once work is complete, be sure to close the control box cover.

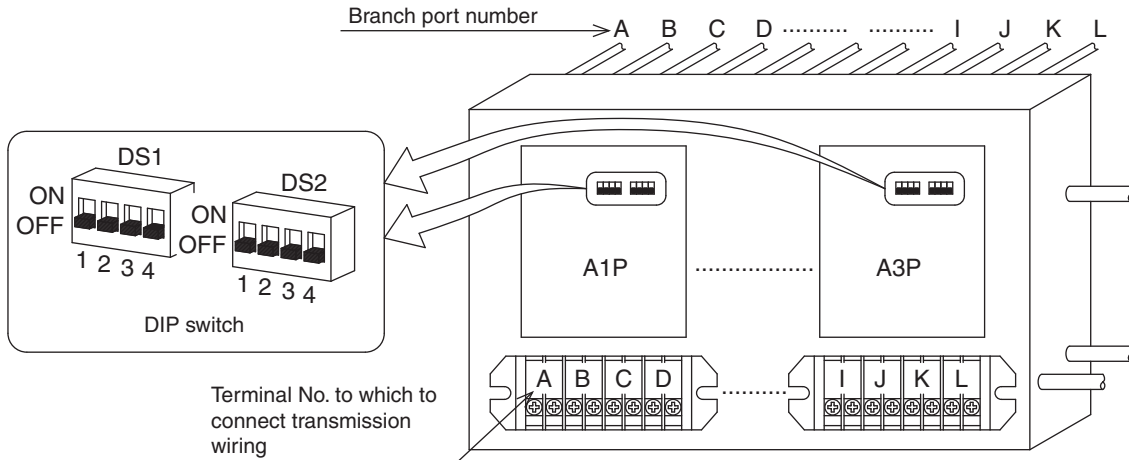

**Setting**

1. Setting for branch ports to which no indoor unit is connected

	Setting	Setting for branch ports to which no indoor unit is connected (Example 1)											
	DIP switch setting	ON (Not connected) OFF (Factory default)											
	DIP switch No.	DS1 (A1P)				DS1 (A2P)				DS1 (A3P)			
		1	2	3	4	1	2	3	4	1	2	3	4
BS4Q54TVJ BS4Q54TAVJ	Target branch port												
BS6Q54TVJ													
BS8Q54TVJ													
BS10Q54TVJ BS10Q54TAVJ													
BS12Q54TVJ BS12Q54TAVJ		Unit A	Unit B	Unit C	Unit D	Unit E	Unit F	Unit G	Unit H	Unit I	Unit J	Unit K	Unit L

(Example 1)  
When not connecting the indoor unit to the A and B branch circuits

DS1 (A1P)  
ON  
OFF  
1 2 3 4  
↑ ↑

2. Setting when joining branch ports

	Setting	Setting when joining branch ports (Example 2)					
	DIP switch setting	ON (Joined) OFF (Factory default)					
	DIP switch No.	DS2 (A1P)		DS2 (A2P)		DS2 (A3P)	
		1	2	1	2	1	2
BS4Q54TVJ BS4Q54TAVJ	Target branch port	A and B units joined		C and D units joined		E and F units joined	
BS6Q54TVJ		C and D units joined		E and F units joined		G and H units joined	
BS8Q54TVJ		E and F units joined		G and H units joined		I and J units joined	
BS10Q54TVJ BS10Q54TAVJ		G and H units joined		I and J units joined		K and L units joined	
BS12Q54TVJ BS12Q54TAVJ		I and J units joined		K and L units joined			
		K and L units joined					

(Example 2)  
When joining the A and B branches

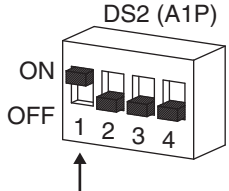

When joining branches, only the branch port combinations shown in the above table can be used. (For example, units B and C cannot be joined.)

### 3.3 Field Settings for Multi Branch Selector Unit (Flex Series)

Follow the instructions below to set the DIP switches as necessary.



**Warning**

Electric shock hazard! Before performing work, be sure to disconnect any power source connected to the unit.

**Procedure**

1. Disconnect the power supply.
2. Set the DIP switches (DS1, DS2) for the corresponding branch ports based on the following table.
3. Once work is complete, be sure to close the control box cover.

**BSF4Q54TVJ**

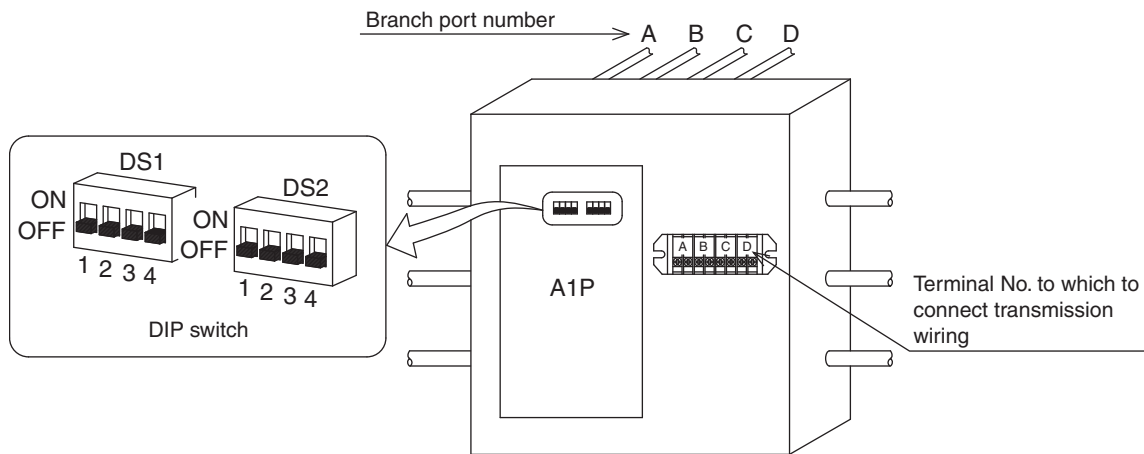

**BSF6/8Q54TVJ**

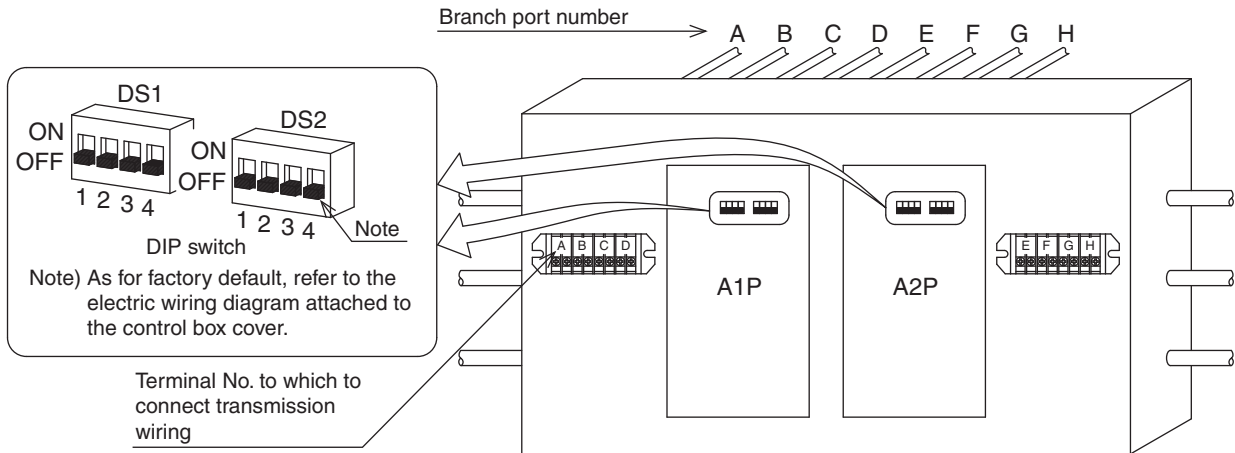

**Setting**

**1. Setting for branch ports to which no indoor unit is connected**

	Setting	Setting for branch ports to which no indoor unit is connected (Example 1)							
	DIP switch setting	ON (Not connected) OFF (Factory default)							
	DIP switch No.	DS1 (A1P)				DS1 (A2P)			
		1	2	3	4	1	2	3	4
BSF4Q54TVJ	Target branch port								
BSF6Q54TVJ									
BSF8Q54TVJ		Unit A	Unit B	Unit C	Unit D	Unit E	Unit F	Unit G	Unit H

(Example 1)  
When not connecting the indoor unit to the A and B branch ports

DS1 (A1P)  
ON OFF  
1 2 3 4

**2. Setting when joining branch ports**

	Setting	Setting when joining branch ports (Example 2)			
	DIP switch setting	ON (Joined) OFF (Factory default)			
	DIP switch No.	DS2 (A1P)		DS2 (A2P)	
		1	2	1	2
BSF4Q54TVJ	Target branch port				
BSF6Q54TVJ		Unit A and B joined	Unit C and D joined	Unit E and F joined	Unit G and H joined
BSF8Q54TVJ					

(Example 2)  
When joining the A and B branch ports

DS2 (A1P)  
ON OFF  
1 2 3 4

When joining branches, only the branch port combinations shown in the above table can be used. (For example, units B and C cannot be joined.)

### 3.4 How to Check Miswiring for Multi Branch Selector Unit

**When miswiring of the transmission wire between the Branch Selector unit and the indoor unit is suspected**

It is possible to check the miswiring by operating the DIP switches to turn ON the corresponding indoor fans to see which wires are miswired according to the procedure below.



**Caution**

All the DIP switches must be restored to their original position after the check. Do not touch any switches other than those indicated.

In case of BS12Q54TVJ

1. Turn OFF the power of the Branch Selector unit.
2. Turn OFF all the DIP switches of DS1 on the PCBs.
3. Turn ON all the DS2-3.

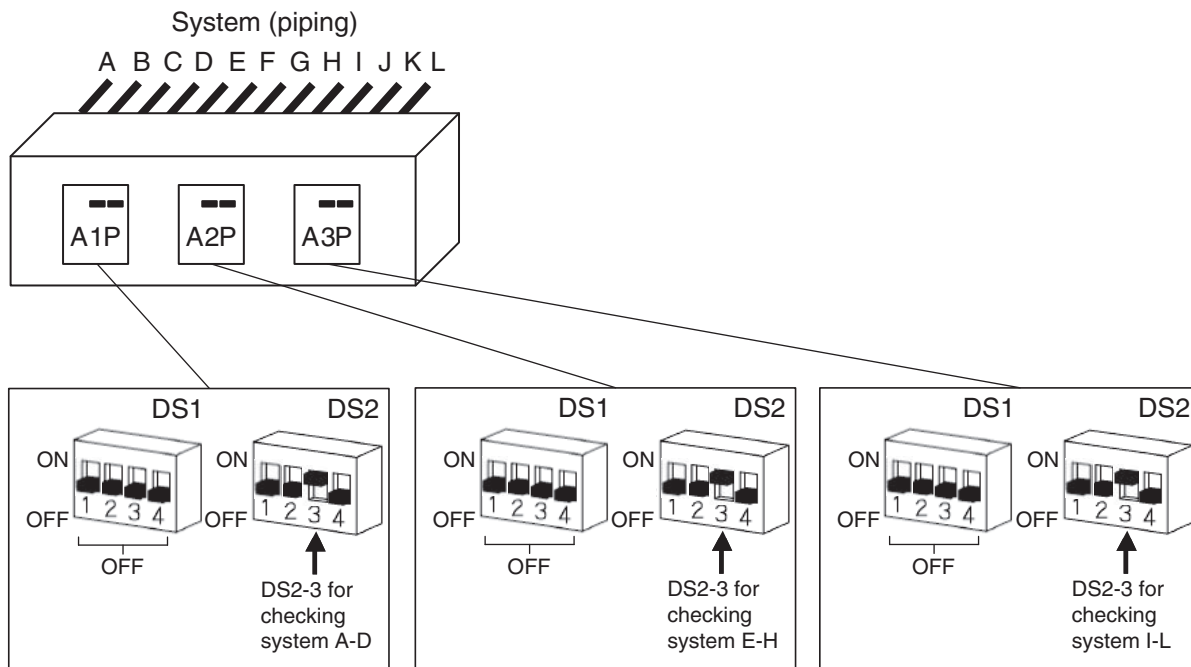

4. Turn ON the power of the Branch Selector unit.
5. Turn ON the DIP switch of DS1 corresponding to the system to be checked.  
(For example, when checking the system C, Turn ON DS1-3 on A1P.)

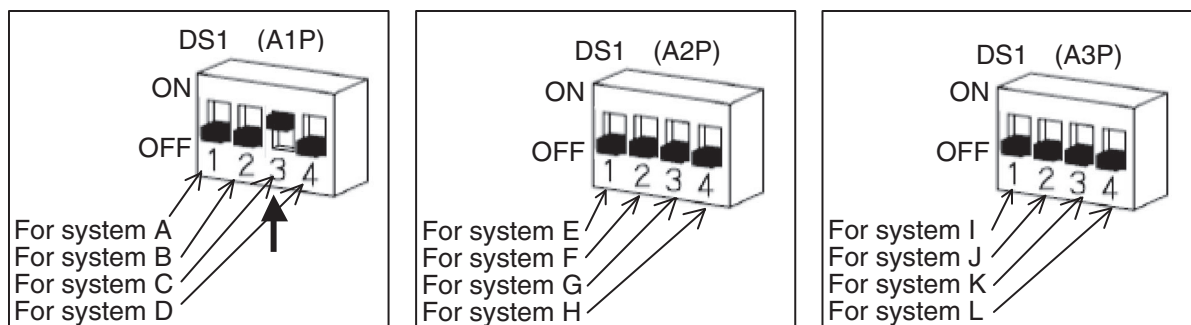

6. If the relevant indoor fan is on, it is OK. If another indoor fan is on, correct the wiring.
7. After the check is completed, turn OFF the power of the Branch Selector unit.
8. Turn OFF all the DS2-3.
9. If there is a branch port to which no indoor unit is connected, or if the branch ports are to be joined, perform field setting referring to pages 280 and 281.
10. Turn ON the power of the Branch Selector unit.

## 4. Test Operation

### 4.1 Checks before Test Operation

Before carrying out a test operation, proceed as follows:

Step	Action
1	Make sure the voltage at the primary side of the safety breaker is: 187 - 253 V (-AATJA, -AATJB) or 416 - 508 V (-AAYDA, -AAYDB)
2	Fully open the liquid and the gas stop valve.

### 4.2 Checkpoints

To carry out a test operation, check the following:

- Check that the temperature setting of the remote controller is at the lowest level in cooling mode or use test mode.
- Go through the following checklist:

Checkpoints	Cautions or warnings
Are all units securely installed?	<ul style="list-style-type: none"> <li>● Dangerous for turning over during storm</li> <li>● Possible damage to pipe connections</li> </ul>
Is the ground wire installed according to the applicable local standard?	Dangerous if electric leakage occurs
Are all air inlets and outlets of the indoor and outdoor units unobstructed?	<ul style="list-style-type: none"> <li>● Poor cooling</li> <li>● Poor heating</li> </ul>
Does the drain flow out smoothly?	Water leakage
Is piping adequately heat-insulated?	Water leakage
Have the connections been checked for gas leakage?	<ul style="list-style-type: none"> <li>● Poor cooling</li> <li>● Poor heating</li> <li>● Stop</li> </ul>
Is the supply voltage conform to the specifications on the name plate?	Incorrect operation
Are the cable sizes as specified and according to local regulations?	Damage of cables
Are the remote controller signals received by the unit?	No operation

## 4.3 Gas Furnace Test Operation



### Caution

Always use the remote controller to stop the test operation.

The test should be performed with the following procedure.

1. All install process, including heat pump system, has been done.
2. Test operation of heat pump system has been successfully completed.
3. Turn off remote controller connected to CXTQ-TA.
4. Change the setting according to the following table.
5. Turn on remote controller connected to CXTQ-TA.
6. The compressor will be forcibly stopped if the compressor is running at this time. After that, the gas furnace will run in tens of seconds. (Tens of minutes might well be needed to stop compressor if the outdoor unit is particular operation.)
7. The gas furnace will operate with selected heat stage.
8. This test operation will stop automatically after 30 minutes or when the remote controller is turned off.

★: Factory setting

Mode No.	First Code No.	Second Code No.	Gas furnace test mode
14 (24)	11	<b>01★</b>	<b>OFF★</b>
		02	Low heat
		03	High heat



### Note(s)

- ◆ Heat pump operation is not allowed during this test operation.
- ◆ When the heat pump is in service mode (test mode, pump down mode, refrigerant charge mode, etc.), this gas furnace test will not start.
- ◆ This setting will be returned to factory setting automatically after finishing test operation.



# Part 6

## Service Diagnosis

1. Symptom-based Troubleshooting .....	289
1.1 Indoor Unit Overall .....	289
1.2 With Gas Furnace .....	292
1.3 Gas Furnace Lockout Reset.....	292
1.4 With Infrared Presence/Floor Sensor .....	293
2. Error Code via Remote Controller.....	294
2.1 BRC1E73 .....	294
2.2 BRC1H71W.....	295
2.3 Wireless Remote Controller .....	295
3. Troubleshooting by Error Code .....	297
3.1 Error Codes and Descriptions .....	297
3.2 Error Codes (Sub Codes).....	299
3.3 Prediction Codes .....	309
3.4 External Protection Device Abnormality .....	313
3.5 Indoor Unit Control PCB Abnormality .....	315
3.6 Drain Level Control System Abnormality.....	316
3.7 Indoor Fan Motor Lock, Overload.....	318
3.8 Indoor Fan Motor Abnormality .....	320
3.9 Overload/Overcurrent/Lock of Indoor Fan Motor.....	326
3.10 Blower Motor Not Running .....	327
3.11 Indoor Fan Motor Status Abnormality.....	328
3.12 Low Indoor Airflow .....	329
3.13 Swing Flap Motor Abnormality .....	330
3.14 Power Supply Voltage Abnormality .....	332
3.15 Blower Motor Stops for Over/Under Voltage .....	333
3.16 Electronic Expansion Valve Coil Abnormality, Dust Clogging .....	334
3.17 Gas Furnace Abnormality.....	335
3.18 Drain Level above Limit.....	336
3.19 Self-Cleaning Decoration Panel Abnormality .....	337
3.20 Defective Capacity Setting .....	348
3.21 Transmission Abnormality between Indoor Unit Control PCB and Fan PCB .....	349
3.22 Blower Motor Communication Error .....	351
3.23 Climate Talk Communication Error .....	352
3.24 Thermistor Abnormality .....	353
3.25 Combination Error between Indoor Unit Control PCB and Fan PCB .....	354
3.26 Capacity Setting Abnormality .....	355
3.27 Blower Motor HP Mismatch.....	356
3.28 Indoor Blower Does Not Have Required Parameters to Function.....	357

3.29 Remote Sensor Abnormality .....	358
3.30 Humidity Sensor System Abnormality .....	359
3.31 Infrared Presence/Floor Sensor Error .....	360
3.32 Remote Controller Thermistor Abnormality .....	365
3.33 Outdoor Unit Main/Sub PCB Abnormality .....	366
3.34 Detection of Ground Leakage by Leak Detection Circuit .....	367
3.35 Missing of Ground Leakage Detection Core .....	368
3.36 Activation of High Pressure Switch .....	369
3.37 Activation of Low Pressure Sensor .....	371
3.38 Compressor Motor Lock .....	372
3.39 Compressor Damage Alarm .....	374
3.40 Outdoor Fan Motor Abnormality .....	376
3.41 Electronic Expansion Valve Coil Abnormality or Sub PCB Momentary Overcurrent .....	378
3.42 Four Way Valve Abnormality (Intermediate Stop) .....	379
3.43 Four Way Valve Abnormality (Not Switching) .....	380
3.44 Opposite Air Conditioning Alarm .....	382
3.45 Discharge Pipe Temperature Abnormality .....	383
3.46 Wet Alarm .....	385
3.47 Refrigerant Overcharged .....	387
3.48 Branch Selector Unit Electronic Expansion Valve Abnormality .....	388
3.49 Thermistor Abnormality .....	390
3.50 Harness Abnormality (between Outdoor Unit Main PCB and Inverter PCB) .....	391
3.51 Outdoor Fan PCB Abnormality .....	392
3.52 High Pressure Sensor Abnormality .....	393
3.53 Low Pressure Sensor Abnormality .....	394
3.54 Inverter PCB Abnormality .....	395
3.55 Momentary Power Failure during Test Operation .....	397
3.56 Inverter Radiation Fin Temperature Rise Abnormality .....	398
3.57 Compressor Instantaneous Overcurrent .....	401
3.58 Compressor Overcurrent .....	403
3.59 Compressor Startup Abnormality .....	405
3.60 Transmission Error between Inverter PCB and Outdoor Unit Main PCB... ..	407
3.61 Power Supply Voltage Imbalance .....	409
3.62 Inverter Radiation Fin Temperature Abnormality .....	411
3.63 Field Setting Abnormality after Replacing Outdoor Unit Main PCB or Combination of PCB Abnormality .....	413
3.64 Refrigerant Shortage .....	414
3.65 Reverse Phase, Open Phase, Power Supply Frequency Issue .....	415
3.66 Power Supply Insufficient or Instantaneous Abnormality .....	416
3.67 Check Operation Not Executed .....	418
3.68 Transmission Error between Indoor Units and Outdoor Units, Open Phase in Power Supply Wiring .....	419
3.69 Transmission Error between Remote Controller and Indoor Unit .....	422
3.70 Transmission Error between Outdoor Units .....	423
3.71 Transmission Error between Main and Sub Remote Controllers .....	429
3.72 Transmission Error between Indoor Units and Outdoor Units in the Same System .....	430

3.73	Improper Combination of Indoor, Branch Selector and Outdoor Units.....	431
3.74	Incorrect Gas Furnace Connecting Number.....	438
3.75	Incorrect Electric Heater Capacity Setting.....	439
3.76	Address Duplication of Centralized Controller.....	440
3.77	Transmission Error between Centralized Controller and Indoor Unit.....	441
3.78	System Not Set Yet.....	444
3.79	System Abnormality, Refrigerant System Address Undefined.....	445
3.80	Climate Talk Communication System Combination Error (Before Initial Setting for Communication Completes).....	447
3.81	Climate Talk Communication System Combination Error (After Initial Setting for Communication Completes).....	448
4.	Check.....	449
4.1	High Pressure Check.....	449
4.2	Low Pressure Check.....	450
4.3	Superheat Operation Check.....	452
4.4	Power Transistor Check.....	454
4.5	Refrigerant Overcharge Check.....	456
4.6	Refrigerant Shortage Check.....	457
4.7	Vacuumping and Dehydration Procedure.....	458
4.8	Thermistor Check.....	459
4.9	Pressure Sensor Check.....	463
4.10	Broken Wire Check of the Relay Wires.....	464
4.11	Fan Motor Connector Check (Power Supply Cable).....	466
4.12	Fan Motor Connector Check (Signal Cable).....	468
4.13	Electronic Expansion Valve Coil Check.....	470
4.14	Fan Motor Connector Check for FXTQ-TA, FXTQ-TB.....	474

# 1. Symptom-based Troubleshooting

## 1.1 Indoor Unit Overall

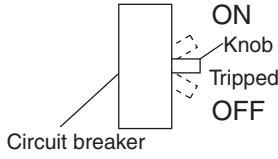
	Symptom	Supposed Cause	Countermeasure	
1	The system does not start operation at all.	Blowout of fuse(s)	Turn OFF the power supply and then replace the fuse (s).	
		Cutout of breaker(s)	<ul style="list-style-type: none"> <li>• If the knob of any breaker is in its OFF position, turn ON the power supply.</li> <li>• If the knob of any circuit breaker is in its tripped position, do not turn ON the power supply.</li> </ul>  <p>The diagram shows a vertical rectangular knob for a circuit breaker. To its right, three horizontal positions are indicated: 'ON' at the top, 'Tripped' in the middle, and 'OFF' at the bottom. A dashed line points from the text 'Circuit breaker' to the knob.</p>	
		Power failure	After the power failure is reset, restart the system.	
		The connector loose or not fully plugged in	Turn off the power supply to verify the connection of the connector.	
2	The system starts operation but makes an immediate stop.	Blocked air inlet or outlet of indoor or outdoor unit	Remove obstacle(s).	
		Clogged air filter(s)	Clean the air filter(s).	
3	The system does not cool or heat air well.	Blocked air inlet or outlet of indoor or outdoor unit	Remove obstacle(s).	
		Clogged air filter(s)	Clean the air filter(s).	
		Enclosed outdoor unit(s)	Remove the enclosure.	
		Improper set temperature	Set the temperature to a proper degree.	
		Airflow rate set to LOW	Set it to a proper airflow rate.	
		Improper direction of air diffusion	Set it to a proper direction.	
		Open window(s) or door(s)	Shut it tightly.	
		<b>IN COOLING</b> Direct sunlight received	Hang curtains or shades on windows.	
		<b>IN COOLING</b> Too many persons staying in a room	The model must be selected to match the air conditioning load.	
		<b>IN COOLING</b> Too many heat sources (e.g. OA equipment) located in a room		
4	The system does not operate.	The system stops and immediately restarts operation.	Normal operation. The system will automatically start operation after a lapse of five minutes.	
		Pressing the temperature setting button immediately resets the system.		
		The remote controller displays <b>CENTRAL CONTROL</b> , which blinks for a period of several seconds when the <b>OPERATION</b> button is depressed.	The system is controlled with centralized controller. Blinking display indicates that the system cannot be operated using the remote controller.	Operate the system using the COOL/HEAT central remote controller.
		The system stops immediately after turning ON the power supply.	The system is in preparation mode of microcomputer operation.	Wait for a period of approximately one minute.
5	The system makes intermittent stops.	The remote controller displays error codes <b>U4</b> or <b>U5</b> , and the system stops but restarts after a lapse of several minutes.	The system stops due to an interruption in communication between units caused by electrical noises coming from equipment other than air conditioners.	Remove causes of electrical noises. If these causes are removed, the system will automatically restart operation.

	Symptom	Supposed Cause	Countermeasure	
6	COOL/HEAT selection is disabled.	The remote controller displays <b>CENTRAL CONTROL</b> .	This remote controller has no option to select cooling operation.	Use a remote controller with option to select cooling operation.
		The remote controller displays <b>CENTRAL CONTROL</b> , and the COOL/HEAT selection remote controller is provided.	COOL/HEAT selection is made using the COOL/HEAT selection remote controller.	Use the COOL/HEAT selection remote controller to select cool or heat.
7	The system conducts fan operation but not cooling or heating operation.	This symptom occurs immediately after turning ON the power supply.	The system is in preparation mode of operation.	Wait for a period of approximately 10 minutes.
		The remote controller displays <b>CENTRAL CONTROL</b> ; no cooling or heating operation is performed. Switch to fan operation.	In thermal storage operation, the unit is set to fan operation in cooling or heating operation, and the remote controller shows <b>CENTRAL CONTROL</b> .	Normal operation.
8	The airflow rate is not reproduced according to the setting.	Even pressing the airflow rate setting button makes no changes in the airflow rate.	In heating operation, when the room temperature reaches the set degree, the outdoor unit will stop while the indoor unit is brought to fan LL operation so that no one gets cold air. Furthermore, if fan operation mode is selected when other indoor unit is in heating operation, the system will be brought to fan LL operation.	Normal operation.
9	The airflow direction is not reproduced according to the setting.	The airflow direction is not corresponding to that displayed on the remote controller. The flap does not swing.	Automatic control	Normal operation.
10	A white mist comes out from the system.	<b>Indoor unit</b> In cooling operation, the ambient humidity is high. (This indoor unit is installed in a place with much oil or dust.)	Uneven temperature distribution due to heavy stain of the inside of the indoor unit	Clean the inside of the indoor unit.
		<b>Indoor unit</b> Immediately after cooling operation stopping, the indoor air temperature and humidity are low.	Hot gas (refrigerant) that has flowed in the indoor unit results to be vapor from the unit.	Normal operation.
		<b>Indoor and outdoor units</b> After the completion of defrost operation, the system is switched to heating operation.	Defrosted moisture turns to be vapor and comes out from the units.	Normal operation.

	Symptom	Supposed Cause	Countermeasure	
11	The system produces sounds.	<b>Indoor unit</b> Immediately after turning ON the power supply, indoor unit produces ringing sounds.	These are operating sounds of the electronic expansion valve of the indoor unit.	Normal operation. This sound becomes low after a lapse of approximately one minute.
		<b>Indoor and outdoor units</b> Hissing sounds are continuously produced while in cooling or defrost operation.	These sounds are produced from gas (refrigerant) flowing respectively through the indoor and outdoor units.	Normal operation.
		<b>Indoor and outdoor units</b> Hissing sounds are produced immediately after the startup or stop of the system, or the startup or stop of defrost operation.	These sounds are produced when the gas (refrigerant) stops or changes flowing.	Normal operation.
		<b>Indoor unit</b> Faint sounds are continuously produced while in cooling operation or after stopping the operation.	These sounds are produced from the drain discharge device in operation.	Normal operation.
		<b>Indoor unit</b> Creaking sounds are produced while in heating operation or after stopping the operation.	These sounds are produced from resin parts expanding and contracting with temperature changes.	Normal operation.
		<b>Indoor unit</b> Sounds like trickling or the like are produced from indoor units in the stopped state.	On <b>VRV</b> systems, these sounds are produced when other indoor units in operation. The reason is that the system runs in order to prevent oil or refrigerant from dwelling.	Normal operation.
		<b>Outdoor unit</b> Pitch of operating sounds changes.	The reason is that the compressor changes the operating frequency.	Normal operation.
12	Dust comes out from the system.	Dust comes out from the system when it restarts after the stop for an extended period of time.	Dust, which has deposited on the inside of indoor unit, is blown out from the system.	Normal operation.
13	Odors come out from the system.	In operation	Odors of room, cigarettes or else adsorbed to the inside of indoor unit are blown out.	The inside of the indoor unit should be cleaned.
14	Outdoor fan does not rotate.	In operation	The reason is that fan revolutions are controlled to put the operation to the optimum state.	Normal operation.
15	LCD display <b>88</b> or <b>Checking the connection.</b> <b>Please stand by.</b> appears on the remote controller.	Immediately after turning ON the power supply	The reason is that the system is checking to be sure the remote controller is normal.	Normal operation. This code is displayed for a period of approximately one minute at maximum.
16	The outdoor unit compressor or the outdoor fan does not stop.	After stopping operation	It stops in order to prevent oil or refrigerant from dwelling.	Normal operation. It stops after a lapse of approximately 5 to 10 minutes.
17	The outdoor gets hot.	While stopping operation	The reason is that the compressor is warmed up to provide smooth startup of the system.	Normal operation.
18	Hot air comes out from the system even though it stops.	Hot air is felt while the system stops.	On <b>VRV</b> systems, small quantity of refrigerant is fed to indoor units in the stopped state when other indoor units are in operation.	Normal operation.

## 1.2 With Gas Furnace

	Symptom	Supposed Cause
1	The gas furnace does not start operation.	The gas furnace does not start operation while the compressor is during operation or under stop-control, or right after defrost IN or defrost OUT. Wait until the operation becomes stable.
2	Operation does not switch from heat pump to gas furnace in spite of low room temperature. Operation does not switch from gas furnace to heat pump even though the room temperature is nearing the set temperature.	This function is performed only with outdoor units which support automatic switching between gas furnace and heat pump <u>interlocking with room temperature</u> . Some models are enabled to support automatic switching between gas furnace and heat pump <u>interlocking with outdoor air temperature</u> by setting heat pump lockout on an outdoor unit side. However, the compressor stops while gas furnace is during operation.
3	<b>AA-03</b> (Gas furnace abnormality) is indicated on the remote controller while no error is indicated on the PCB of the gas furnace.	In some cases of gas furnace abnormality, error indication on the remote controller is retained even after the abnormality is removed. Execute combustion heating operation once or reset the power source.
4	The airflow rate indication on the remote controller is not consistent with the actual airflow rate of the indoor unit.	The airflow rate of the indoor unit during gas furnace combustion heating depends on the intensity of combustion. Therefore, the airflow rate of the indoor unit does not reflect the airflow setting of the remote controller.

## 1.3 Gas Furnace Lockout Reset

Furnace lockout is characterized by a non-functioning furnace (circulator blower may be running continuously) providing a diagnostic LED code located on the furnace board.

Lockout results when a furnace control detects abnormal conditions. If the furnace is in "lockout", the following methods can be used to clear the error.

- a. Turn the remote controller OFF to clear the error. If the error is not cleared, proceed to next step.
- b. Heat pump lockout conditions are met.
- c. Set the setting temperature to maximum, then turn the remote controller ON.
- d. Turn the remote controller OFF.
- e. Turn the remote controller ON after around 15 seconds from procedure d.

The procedures c, d, and e will not work during certain outdoor unit operations, i.e. defrost, startup, compressor stop, service mode etc.

If the LED of the **ON/OFF** button is flashing when you turn the remote controller ON, you cannot clear the error with the method above. In that case, the error must be cleared using the gas furnace. Refer to the gas furnace operation manual for more details.

## 1.4 With Infrared Presence/Floor Sensor

	Condition	Measure
1	Louver operation different from setting or no downward airflow in heating operation	Refer to the flowchart below.
2	Individual airflow direction setting different from the actual airflow direction	Refer to the flowchart below.
3	While not operating, the louver does not close completely.	Turn off the circuit breaker and then turn it on again.
4	The remote controller menu does not display energy saving operating mode for when people are not present.	Refer to <b>Infrared Presence/Floor Sensor Error (CE)</b> on page 360.
	The remote controller menu does not display the stop function for when people are not present.	
	The remote controller menu does not display the automatic draft prevention function.	
5	The menu does not display the eco-friendly display function.	No defect. Set the clock.
6	During cooling and dry operation, the louver automatically switches from horizontal (P0) to one-level downward (P1).	No defect. When relative ambient humidity is higher, automatic louver control will be activated.
7	During heating operation, the use of an airflow block will not cause other louvers to turn downward (P4).	No defect. In heating operation, if an airflow block is set, then the air outlet control outdoor the airflow block will be within the range P0-P3.
8	When using airflow block, the airflow block will be routinely lifted (become horizontal) during heating operation.	No defect. Set louver to horizontal (P0) during thermostat OFF.
9	The infrared presence sensor determines that there is someone in the room while no one is there.	Check if there are any objects that generate temperature change when moving. For example: · An electric heater with swing function · Doors, curtains, blind switches · Output of paper from a fax machine or a printer · Turning on/off of incandescent lights · Moving objects
	The infrared presence sensor determines that there is no one in the room while someone is there.	
10	The infrared presence sensor determines that there is no one in the room while someone is there.	Check for the following conditions. · Lack of movement · Facing away from the sensor · Little skin exposed · Slight movement in a place far from the sensor
11	Large difference between floor temperature and actual temperature	Check for the following conditions. · Sensor detection zone affected by solar radiation · High or low temperature objects in the sensor detection zone · Large difference between floor temperature and temperature of the living space · Sensors installed near walls may be affected by wall temperature.

### Error diagnosis when the louver movement differs from the setting

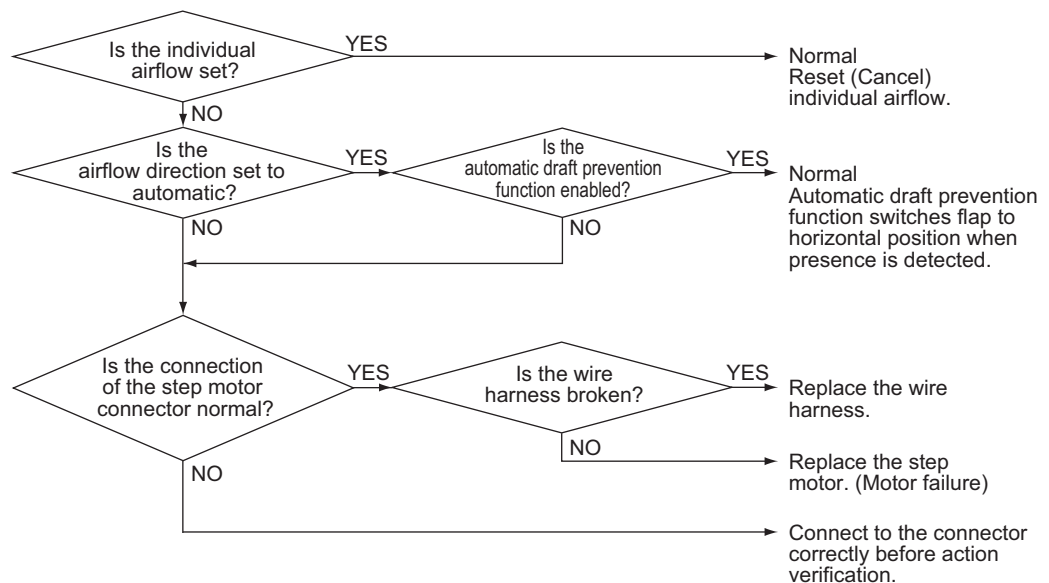



## 2. Error Code via Remote Controller

### 2.1 BRC1E73

The following will be displayed on the screen when an error (or a warning) occurs during operation. Check the error code and take the corrective action specified for the particular model.

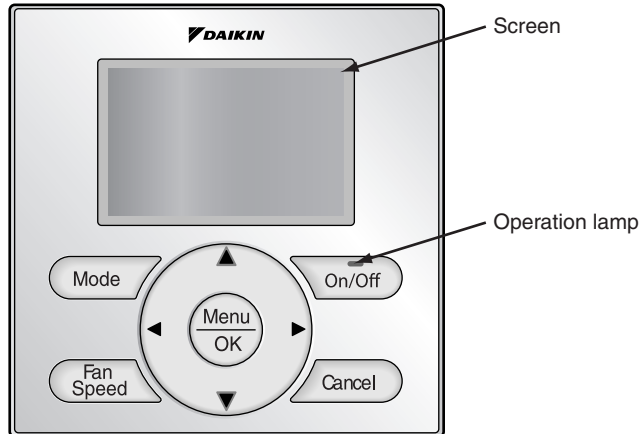

#### (1) Checking an error or warning.

	Operation Status	Display	
Abnormal shutdown	The system stops operating.	The operation lamp (green) starts to blink. The message <b>Error: Push Menu button</b> will blink at the bottom of the screen.	
Warning	The system continues its operation.	The operation lamp (green) remains on. The message <b>Warning: Push Menu button</b> will blink at the bottom of the screen.	

#### (2) Taking corrective action.

Press the **Menu/OK** button to check the error code.





Take the corrective action specific to the model.

Error Code: A6-01		— Error code
Indoor Model	FXFQ07TVJU	— Applicable model names
Outdoor Model	REYQ72AATJA	

## 2.2 BRC1H71W

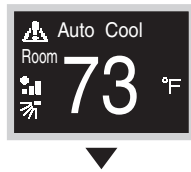
Home screen



When the indoor unit is in error, the controller will display  on the home screen.

Information screen

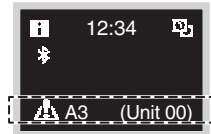



Press and hold  on the Home screen for 5 seconds. The unit number and error code will be displayed at the bottom of the information screen.

## 2.3 Wireless Remote Controller

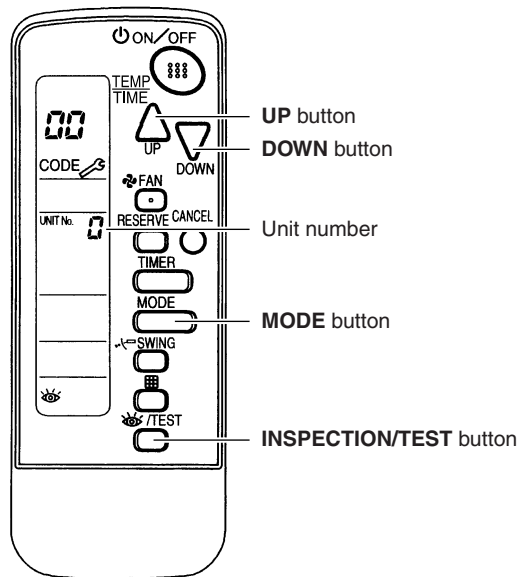
If the unit stops due to an error, the operation indicating LED on the signal receiving part of indoor unit blinks. The error code can be determined by following the procedure described below. (The error code is displayed when an operation error has occurred. In normal condition, the error code of the last problem is displayed.)



1. Press **INSPECTION/TEST** button to enter inspection mode. Then the figure  blinks on the unit number display.
2. Press **UP** button or **DOWN** button and change the unit number until the receiver of the remote controller starts to beep.  
**3 short beeps:** Follow all steps below.  
**1 short beep:** Follow steps 3 and 4. Continue the operation in step 4 until you hear a continuous beep. This continuous beep indicates that the error code is confirmed.  
**Continuous beep:** There is no abnormality.
3. Press **MODE** button. The left  (upper digit) indication of the error code blinks.
4. Press **UP** button or **DOWN** button to change the error code upper digit until the receiver of the indoor unit starts to beep.

- The upper digit of the code changes as shown below.

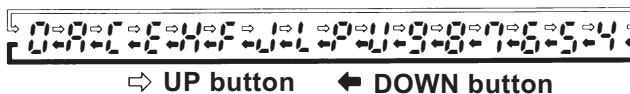

**Continuous beep:** Both upper and lower digits match. (Error code is confirmed.)

**2 short beeps:** The upper digit matches but the lower digit does not.

**1 short beep:** The upper digit does not match.

5. Press **MODE** button. The right (lower digit) indication of the error code blinks.
6. Press **UP** button or **DOWN** button and change the error code lower digit until the receiver of the indoor unit generates a continuous beep.

- The lower digit of the code changes as shown below.



**Continuous beep:** Both upper and lower digits match. (Error code is confirmed.)

**2 short beeps:** The upper digit matches but the lower digit does not.

**1 short beep:** The upper digit does not match.

7. Press **MODE** button to return to the normal mode. If you do not press any button for 1 minute, the remote controller automatically returns to the normal mode.

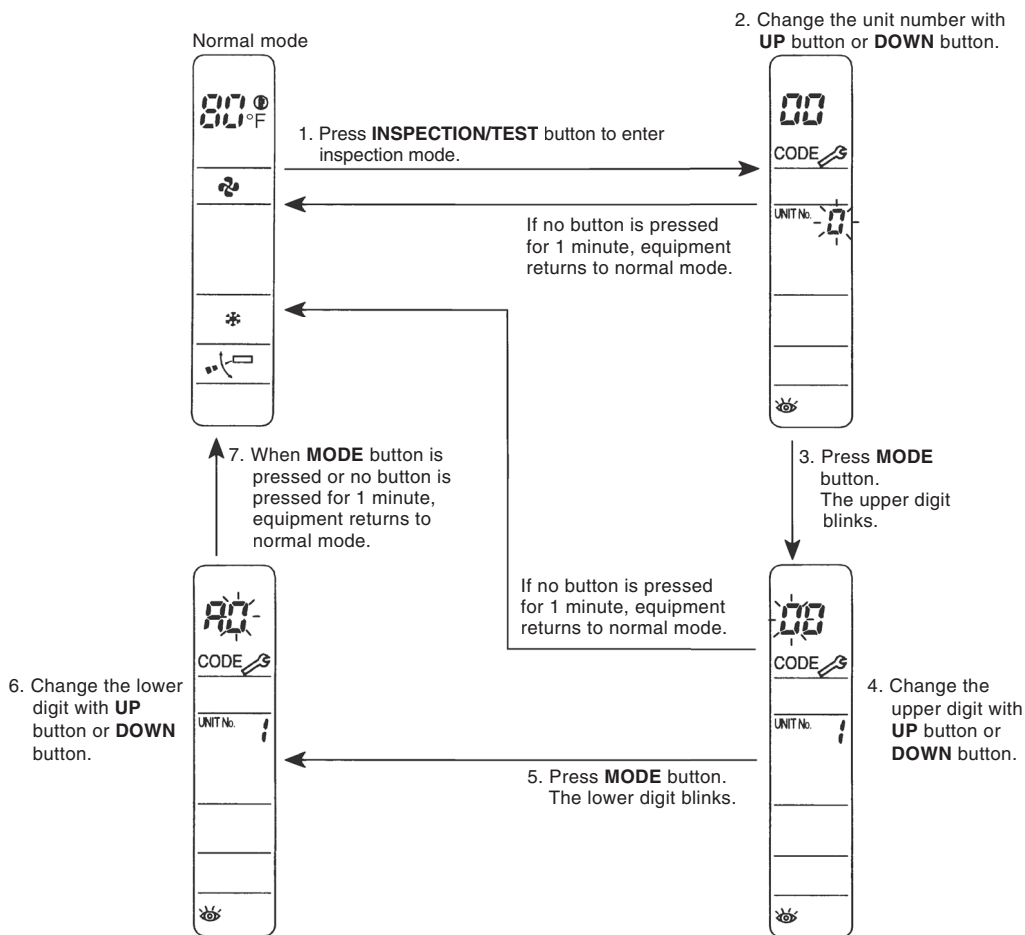

### 3. Troubleshooting by Error Code

#### 3.1 Error Codes and Descriptions

○: ON ●: OFF ◐: Blink

	Error code	Operation lamp	Error contents	Reference page
Indoor Unit	A0	◐	External protection device abnormality	313
	A1	◐	Indoor unit control PCB abnormality	315
	A3	◐	Drain level control system abnormality	316
	A6	◐	Indoor fan motor lock, overload	318
			Indoor fan motor abnormality	320
			Overload/overcurrent/lock of indoor fan motor	326
			Blower motor not running	327
			Indoor fan motor status abnormality	328
			Low indoor airflow	329
	A7 (*1)	○	Swing flap motor abnormality	330
	A8	◐	Power supply voltage abnormality	332
			Blower motor stops for over/under voltage	333
	A9	◐	Electronic expansion valve coil abnormality, dust clogging	334
	AA	◐	Gas furnace abnormality	335
	AF (*1)	○	Drain level above limit	336
	AH	◐	Self-cleaning decoration panel abnormality	337
	AJ	◐	Defective capacity setting	348
	C1	◐	Transmission abnormality between indoor unit control PCB and fan PCB	349
			Blower motor communication error	351
			Climate Talk communication error	352
	C4	◐	Indoor heat exchanger liquid pipe thermistor abnormality	353
	C5	◐	Indoor heat exchanger gas pipe thermistor abnormality	353
	C6	◐	Combination error between indoor unit control PCB and fan PCB	354
			Capacity setting abnormality	355
			Blower motor HP mismatch	356
			Indoor blower does not have required parameters to function	357
C9 (*2)	◐	Suction air thermistor abnormality	353	
		Remote sensor abnormality	358	
CA	◐	Discharge air thermistor abnormality	353	
CC	○	Humidity sensor system abnormality	359	
CE (*1)	○	Infrared presence/floor sensor error	360	
CJ (*2)	○	Remote controller thermistor abnormality	365	
Outdoor Unit	E1	◐	Outdoor unit main/sub PCB abnormality	366
	E2	◐	Detection of ground leakage by leak detection circuit	367
			Missing of ground leakage detection core	368
	E3	◐	Activation of high pressure switch	369
	E4	◐	Activation of low pressure sensor	371
	E5	◐	Compressor motor lock	372
	E6	◐	Compressor damage alarm	374
	E7	◐	Outdoor fan motor abnormality	376
	E9	◐	Electronic expansion valve coil abnormality	378
			Sub PCB momentary overcurrent	378
	EA	◐	Four way valve abnormality (intermediate stop)	379
			Four way valve abnormality (not switching)	380
			Opposite air conditioning alarm	382
	F3	◐	Discharge pipe temperature abnormality	383
F4	○ / ◐	Wet alarm	385	
F6	◐	Refrigerant overcharged	387	
Branch Selector Unit	F9	◐	Branch Selector unit electronic expansion valve abnormality	388

	Error code	Operation lamp	Error contents	Reference page
Outdoor Unit	H1	●	Box air thermistor abnormality	390
	H3	●	Harness abnormality (between outdoor unit main PCB and inverter PCB)	391
	H7	●	Outdoor fan PCB abnormality	392
	H9	●	Outdoor air thermistor abnormality	390
	J3	●	Discharge pipe thermistor abnormality Compressor body thermistor abnormality	390
	J5	●	Compressor suction thermistor abnormality Suction pipe before accumulator thermistor abnormality	390
	J6	●	Heat exchanger deicer thermistor abnormality Heat exchanger gas pipe thermistor abnormality	390
	J7	●	Receiver inlet thermistor abnormality Subcooling heat exchanger liquid pipe thermistor abnormality Subcooling injection thermistor abnormality	390
	J8	●	Heat exchanger liquid pipe thermistor abnormality	390
	J9	●	Subcooling heat exchanger gas pipe thermistor abnormality Receiver gas purge thermistor abnormality Electrical box air outlet thermistor abnormality	390
	JA	●	High pressure sensor abnormality	393
	JC	●	Low pressure sensor abnormality	394
	L1	●	Inverter PCB abnormality	395
	L2	●	Momentary power failure during test operation	397
	L4	●	Inverter radiation fin temperature rise abnormality	398
	L5	●	Compressor instantaneous overcurrent	401
	L8	●	Compressor overcurrent	403
	L9	●	Compressor startup abnormality	405
	LC	●	Transmission error between inverter PCB and outdoor unit main PCB	407
	P1	●	Power supply voltage imbalance	409
P4 (*1)	●	Inverter radiation fin temperature abnormality	411	
PJ	●	Field setting abnormality after replacing outdoor unit main PCB or combination of PCB abnormality	413	
System	U0 (*1)	○	Refrigerant shortage	414
	U1	●	Reverse phase, Open phase, Power supply frequency issue	415
	U2	●	Power supply insufficient or instantaneous abnormality	416
	U3	●	Check operation not executed	418
	U4	●	Transmission error between indoor units and outdoor units, open phase in power supply wiring	419
	U5	●	Transmission error between remote controller and indoor unit	422
	U7	●	Transmission error between outdoor units	423
	U8	●	Transmission error between main and sub remote controllers	429
	U9	●	Transmission error between indoor units and outdoor units in the same system	430
	UA	●	Improper combination of indoor, Branch Selector and outdoor units	431
			Incorrect gas furnace connecting number	438
			Incorrect electric heater capacity setting	439
	UC (*1)	○	Address duplication of centralized controller	440
	UE	●	Transmission error between centralized controller and indoor unit	441
	UF	●	System not set yet	444
	UH	●	System abnormality, refrigerant system address undefined	445
Climate Talk communication system combination error (before initial setting for communication completes)			447	
Climate Talk communication system combination error (after initial setting for communication completes)			448	

**Note(s)**

- \*1. The system can keep operating, however, be sure to check and repair.
- \*2. The system may continue operation depending on the conditions.

## 3.2 Error Codes (Sub Codes)

If an error code like the one shown below is displayed when a wired remote controller is in use, make a detailed diagnosis or a diagnosis of the relevant unit.

### 3.2.1 Indoor Unit

Error code	Troubleshooting	
	Error Description	Diagnosis
A0 - 01	External protection device abnormality	Refer to page 314.
A6 - 01	Fan motor locked	A locked fan motor current has been detected. Turn the fan by hand to check for the connection of connectors.
A6 - 10	Fan overcurrent error	A fan motor overcurrent has been detected. Check for the connection of the connector between the fan motor and the fan PCB. If the connection is normal, replace the fan motor. If this still cannot solve the error, replace the fan PCB.
A6 - 11	Fan position detection error	An error in the detection of position of the fan motor. Check for the connection of the connector between the fan motor and the fan PCB. If the connection is normal, replace the fan motor. If this still cannot solve the error, replace the fan PCB.
A6 - 20	Indoor fan motor status abnormality	Refer to page 328.
A6 - 21	Low indoor airflow	Refer to page 329.
A8 - 01	Power supply voltage error	Check for the input voltage of the fan motor.
A9 - 01	Electronic expansion valve error	There is an error in the electronic expansion valve coil or a connector disconnected.
A9 - 02	Refrigerant leakage detection error	Refrigerant leaks even if the electronic expansion valve is closed. Replace the electronic expansion valve.
AA - 03	Gas furnace abnormality	Refer to page 335.
AH - 03	Transmission error (between the self-cleaning decoration panel and the indoor unit) (when the self-cleaning decoration panel is mounted)	Check for the connection of the harness connector between the panel PCB and the indoor unit PCB.
AH - 04	Dust detection sensor error (when the self-cleaning decoration panel is mounted)	Check for the connections of the connector X12A on the panel PCB and the connectors X18A and X19A on the sensor PCB.
AH - 05	Dust collection sign error (when the self-cleaning decoration panel is mounted)	Check for clogging with dust at the dust collection port as well as in the brush unit, S-shaped pipe, and dust box. Furthermore, check for any stains of the light receiving and emitting parts of the infrared unit.
AH - 06	Air filter rotation error (when the self-cleaning decoration panel is mounted)	Check for anything getting in the way of rotating the filter (e.g. the filter comes off or the drive gear is clogged with foreign matter).
AH - 07	Damper rotation error (when the self-cleaning decoration panel is mounted)	The damper does not rotate normally. Check for any foreign matter around the damper and for the operation of the gear and limit switch.
AH - 08	Filter self-cleaning operation error (when the self-cleaning decoration panel is mounted)	The unit has not yet completed the filter self-cleaning operation even after the lapse of specified period of time. Check for any external noise, etc.
AH - 09	Filter self-cleaning operation start disabled error (when the self-cleaning decoration panel is mounted)	The unit has been put into a state in which the filter self-cleaning operation is disabled. Check the unit for the operating conditions.
AJ - 01	Capacity setting error	There is an error in the capacity setting of the indoor unit PCB.
AJ - 02	Electronic expansion valve setting error	There is a fault in the setting of the gear type electronic expansion valve/direct acting type electronic expansion valve.
C1 - 01	Transmission abnormality between indoor unit PCB and fan PCB	Check for the conditions of transmission between the indoor unit PCB and the fan PCB.
C1 - 07	Blower motor communication error	Refer to page 351.
C1 - 08	Climate Talk Communication error	Refer to page 352.
C6 - 01	Defective combination of indoor unit PCB and the fan PCB	A combination of indoor unit PCB and the fan PCB is defective. Check whether the capacity setting adaptor is correct and the type of the fan PCB is correct.
	Blower motor HP mismatch	Refer to page 356.

Error code	Troubleshooting	
	Error Description	Diagnosis
<b>C6 - 02</b>	Indoor blower does not have required parameters to function	Refer to page 357.
<b>U4 - 01</b>	Indoor-outdoor transmission error	Refer to the <b>U4</b> flowchart.
<b>UA - 13</b>	Refrigerant type error	The type of refrigerant used for the indoor unit is different from that used for the outdoor unit.
<b>UA - 15</b>	Not applicable for self-cleaning decoration panel [when the self-cleaning decoration panel is mounted]	An outdoor unit is not applicable for the self-cleaning decoration panel is connected.
<b>UA - 17</b>	Incorrect electric heater capacity setting	Refer to page 439.
<b>UH - 05</b>	Climate Talk Communication system combination error (before initial setting for communication completes)	Refer to page 447.
<b>UH - 06</b>	Climate Talk Communication system combination error (after initial setting for communication completes)	Refer to page 448.

### 3.2.2 Branch Selector Unit

Error code	Troubleshooting	
	Error Description	Diagnosis
<b>F9 - 01</b>	Branch Selector unit electronic expansion valve abnormality	Refer to the <b>F9</b> flowchart and make a diagnosis based on the Error code shown to the left.
<b>F9 - 02</b>	Branch Selector unit electronic expansion valve abnormality	
<b>F9 - 05</b>	Branch Selector unit electronic expansion valve abnormality	

### 3.2.3 Outdoor Unit, System

Error code	Troubleshooting	
	Error Description	Diagnosis
<b>E1 - 01</b>	Outdoor unit PCB error	Refer to the <b>E1</b> flowchart and make a diagnosis of the relevant unit based on the Error code shown to the left.
<b>E1 - 02</b>	Defective outdoor unit PCB	
<b>E1 - 08</b>	Outdoor unit sub PCB error (Master)	
<b>E1 - 09</b>	Outdoor unit sub PCB error (Sub)	
<b>E2 - 01</b>	Ground leakage detection error (Master)	Refer to the <b>E2</b> flowchart and make a diagnosis of the relevant unit based on the Error code shown to the left.
<b>E2 - 02</b>	Ground leakage detection error (Sub)	
<b>E2 - 06</b>	Missing of ground leakage detection core (Master)	
<b>E2 - 07</b>	Missing of ground leakage detection core (Sub)	
<b>E3 - 01</b>	Activation of high pressure switch S1PH (Master)	Refer to the <b>E3</b> flowchart and make a diagnosis of the relevant unit based on the Error code shown to the left.
<b>E3 - 02</b>	High pressure sensor error (Master)	
<b>E3 - 03</b>	Activation of high pressure switch S1PH (Sub)	
<b>E3 - 04</b>	High pressure sensor error (Sub)	
<b>E3 - 07</b>	High pressure standby E3 latch error (System integrated)	
<b>E3 - 13</b>	Liquid stop valve check error (Master)	
<b>E3 - 14</b>	Liquid stop valve check error (Sub)	
<b>E3 - 18</b>	Overall retry of high pressure switch	
<b>E3 - 20</b>	Activation of high pressure switch S2PH (Master)	
<b>E3 - 21</b>	Activation of high pressure switch S2PH (Sub)	
<b>E4 - 01</b>	Low pressure sensor error (Master)	Refer to the <b>E4</b> flowchart and make a diagnosis of the relevant unit based on the Error code shown to the left.
<b>E4 - 02</b>	Low pressure sensor error (Sub)	
<b>E5 - 01</b>	Compressor M1C lock (Master)	Refer to the <b>E5</b> flowchart and make a diagnosis of the relevant unit based on the Error code shown to the left.
<b>E5 - 02</b>	Compressor M1C lock (Sub)	
<b>E5 - 07</b>	Compressor M2C lock (Master)	
<b>E5 - 08</b>	Compressor M2C lock (Sub)	

Error code	Troubleshooting		
	Error Description	Diagnosis	
<b>E6 - 11</b>	Compressor damage error: Compressor M1C (Master)	Refer to the <b>E6</b> flowchart and make a diagnosis of the relevant unit based on the Error code shown to the left.	
<b>E6 - 12</b>	Compressor damage error: Compressor M2C (Master)		
<b>E6 - 13</b>	Compressor damage error: Compressor M1C (Sub)		
<b>E6 - 14</b>	Compressor damage error: Compressor M2C (Sub)		
<b>E6 - 17</b>	Compressor damage warning: Compressor M1C (Master)		
<b>E6 - 18</b>	Compressor damage warning: Compressor M2C (Master)		
<b>E6 - 19</b>	Compressor damage warning: Compressor M1C (Sub)		
<b>E6 - 20</b>	Compressor damage warning: Compressor M2C (Sub)		
<b>E7 - 01</b>	Fan motor M1F lock (Master)	Make a diagnosis of the fan motor of the relevant unit based on the following.  Fan motor lock: 01, 02, 13, 14 Momentary overcurrent: 05, 06, 17, 18 IPM error: 09, 10, 21, 22	
<b>E7 - 02</b>	Fan motor M2F lock (Master)		
<b>E7 - 05</b>	Fan motor M1F momentary overcurrent (Master)		
<b>E7 - 06</b>	Fan motor M2F momentary overcurrent (Master)		
<b>E7 - 09</b>	Fan motor M1F IPM error (Master)		
<b>E7 - 10</b>	Fan motor M2F IPM error (Master)		
<b>E7 - 13</b>	Fan motor M1F lock (Sub)		
<b>E7 - 14</b>	Fan motor M2F lock (Sub)		
<b>E7 - 17</b>	Fan motor M1F momentary overcurrent (Sub)		
<b>E7 - 18</b>	Fan motor M2F momentary overcurrent (Sub)		
<b>E7 - 21</b>	Fan motor M1F IPM error (Sub)		
<b>E7 - 22</b>	Fan motor M2F IPM error (Sub)		
<b>E9 - 01</b>	Electronic expansion valve coil (Y1E) error (Master)		Refer to the <b>E9</b> flowchart and make a diagnosis of the relevant electronic expansion valve of the relevant unit based on the Error code shown to the left.
<b>E9 - 03</b>	Electronic expansion valve coil (Y2E) error (Master)		
<b>E9 - 04</b>	Electronic expansion valve coil (Y3E) error (Master)		
<b>E9 - 05</b>	Electronic expansion valve coil (Y1E) error (Sub)		
<b>E9 - 06</b>	Electronic expansion valve coil (Y2E) error (Sub)		
<b>E9 - 07</b>	Electronic expansion valve coil (Y3E) error (Sub)		
<b>E9 - 11</b>	Electronic expansion valve coil (Y6E) error (Master)		
<b>E9 - 12</b>	Electronic expansion valve coil (Y6E) error (Sub)		
<b>E9 - 14</b>	Defective electronic expansion valve coil (Y7E) (Master)		
<b>E9 - 15</b>	Defective electronic expansion valve coil (Y7E) (Sub)		
<b>E9 - 20</b>	Defective electronic expansion valve coil (Y1E) (Master)		
<b>E9 - 21</b>	Defective electronic expansion valve coil (Y1E) (Sub)		
<b>E9 - 23</b>	Defective electronic expansion valve coil (Y3E) (Master)		
<b>E9 - 24</b>	Defective electronic expansion valve coil (Y3E) (Sub)		
<b>E9 - 26</b>	Electronic expansion valve coil (Y4E) error (Master)		
<b>E9 - 27</b>	Electronic expansion valve coil (Y4E) error (Sub)		
<b>E9 - 29</b>	Electronic expansion valve coil (Y5E) error (Master)		
<b>E9 - 30</b>	Electronic expansion valve coil (Y7E) error (Master)		
<b>E9 - 31</b>	Electronic expansion valve coil (Y8E) error (Master)		
<b>E9 - 33</b>	Defective electronic expansion valve coil (Y5E) (Master)		
<b>E9 - 34</b>	Electronic expansion valve coil (Y5E) error (Sub)		
<b>E9 - 35</b>	Electronic expansion valve coil (Y7E) error (Sub)		
<b>E9 - 36</b>	Electronic expansion valve coil (Y8E) error (Sub)		
<b>E9 - 38</b>	Defective electronic expansion valve coil (Y5E) (Sub)		
<b>E9 - 44</b>	Defective electronic expansion valve coil (Y2E) (Master)		
<b>E9 - 45</b>	Defective electronic expansion valve coil (Y2E) (Sub)		
<b>E9 - 57</b>	Sub PCB momentary overcurrent (Master)		
<b>E9 - 58</b>	Sub PCB momentary overcurrent (Sub)		



Error code	Troubleshooting	
	Error Description	Diagnosis
<b>EA - 02</b>	Defective four way valve (intermediate stop) (Y10S) (Master)	Refer to the <b>EA</b> flowchart and make a diagnosis of the relevant unit based on the Error code shown to the left.
<b>EA - 03</b>	Defective four way valve (intermediate stop) (Y7S) (Master)	
<b>EA - 04</b>	Defective four way valve (intermediate stop) (Y9S) (Master)	
<b>EA - 05</b>	Defective four way valve (intermediate stop) (Y8S) (Master)	
<b>EA - 06</b>	Defective four way valve (intermediate stop) (Y10S) (Sub)	
<b>EA - 07</b>	Defective four way valve (intermediate stop) (Y7S) (Sub)	
<b>EA - 08</b>	Defective four way valve (intermediate stop) (Y9S) (Sub)	
<b>EA - 09</b>	Defective four way valve (intermediate stop) (Y8S) (Sub)	
<b>EA - 14</b>	Defective four way valve (not switching) (Y10S) (Master)	
<b>EA - 15</b>	Defective four way valve (not switching) (Y7S) (Master)	
<b>EA - 16</b>	Defective four way valve (not switching) (Y9S) (Master)	
<b>EA - 17</b>	Defective four way valve (not switching) (Y8S) (Master)	
<b>EA - 18</b>	Defective four way valve (not switching) (Y10S) (Sub)	
<b>EA - 19</b>	Defective four way valve (not switching) (Y7S) (Sub)	
<b>EA - 20</b>	Defective four way valve (not switching) (Y9S) (Sub)	
<b>EA - 21</b>	Defective four way valve (not switching) (Y8S) (Sub)	
<b>EA - 26</b>	Opposite air conditioning at indoor unit	
<b>F3 - 01</b>	Discharge pipe M1C high temperature error (Master)	
<b>F3 - 03</b>	Discharge pipe M1C high temperature error (Sub)	
<b>F3 - 11</b>	Discharge pipe M2C high temperature error (Master)	
<b>F3 - 13</b>	Discharge pipe M2C high temperature error (Sub)	
<b>F3 - 20</b>	Compressor M1C overheat error (Master)	
<b>F3 - 21</b>	Compressor M1C overheat error (Sub)	
<b>F3 - 25</b>	Compressor M2C overheat error (Master)	
<b>F3 - 26</b>	Compressor M2C overheat error (Sub)	
<b>F4 - 01</b>	Wet alarm	Refer to the <b>F4</b> flowchart and make a diagnosis of the relevant unit based on the Error code shown to the left.
<b>F4 - 02</b>	Wet alarm for compressor M1C (Master)	
<b>F4 - 03</b>	Wet alarm for compressor M2C (Master)	
<b>F4 - 04</b>	Wet alarm for compressor M1C (Sub)	
<b>F4 - 05</b>	Wet alarm for compressor M2C (Sub)	
<b>F4 - 08</b>	Wet error for compressor M1C (Master)	
<b>F4 - 09</b>	Wet error for compressor M2C (Master)	
<b>F4 - 10</b>	Wet error for compressor M1C (Sub)	
<b>F4 - 11</b>	Wet error for compressor M2C (Sub)	
<b>F4 - 14</b>	Indoor unit failure alarm	
<b>F6 - 02</b>	Refrigerant overcharged	Refrigerant overcharge was detected during test operation.
<b>H1 - 01</b>	Defective box air thermistor (R20T) (Master)	Refer to the <b>H1</b> flowchart and make a diagnosis of the relevant unit based on the Error code shown to the left.
<b>H1 - 02</b>	Defective box air thermistor (R20T) (Sub)	
<b>H3 - 02</b>	Harness abnormality (Main & inverter PCB 1) - Master unit	Refer to the <b>H3</b> flowchart and make a diagnosis of the relevant unit based on the Error code shown to the left.
<b>H3 - 03</b>	Harness abnormality (Main & inverter PCB 2) - Master unit	
<b>H3 - 04</b>	Harness abnormality (Main & inverter PCB 1) - Sub unit	
<b>H3 - 05</b>	Harness abnormality (Main & inverter PCB 2) - Sub unit	
<b>H7 - 21</b>	Defective fan PCB (Master): M1F	
<b>H7 - 22</b>	Defective fan PCB (Master): M2F	
<b>H7 - 23</b>	Defective fan PCB (Sub): M1F	
<b>H7 - 24</b>	Defective fan PCB (Sub): M2F	
<b>H9 - 01</b>	Defective outdoor air thermistor (R1T) (Master)	Refer to the <b>H9</b> flowchart and make a diagnosis of the relevant unit based on the Error code shown to the left.
<b>H9 - 02</b>	Defective outdoor air thermistor (R1T) (Sub)	

Error code	Troubleshooting		
	Error Description	Diagnosis	
<b>J3 - 16</b>	Defective M1C discharge pipe thermistor (R15T*): Open (Master) *In case of REYQ72 type, R17T	Refer to the <b>J3</b> flowchart and make a diagnosis of the relevant thermistor of the relevant unit based on the Error code shown to the left.	
<b>J3 - 17</b>	Defective M1C discharge pipe thermistor (R15T*): Short (Master) *In case of REYQ72 type, R17T		
<b>J3 - 18</b>	Defective M2C discharge pipe thermistor (R17T): Open (Master)		
<b>J3 - 19</b>	Defective M2C discharge pipe thermistor (R17T): Short (Master)		
<b>J3 - 22</b>	Defective M1C discharge pipe thermistor (R15T*): Open (Sub) *In case of REYQ72 type, R17T		
<b>J3 - 23</b>	Defective M1C discharge pipe thermistor (R15T*): Short (Sub) *In case of REYQ72 type, R17T		
<b>J3 - 24</b>	Defective M2C discharge pipe thermistor (R17T): Open (Sub)		
<b>J3 - 25</b>	Defective M2C discharge pipe thermistor (R17T): Short (Sub)		
<b>J3 - 38</b>	Defective M2C compressor body thermistor (R18T): Open (Master)		
<b>J3 - 39</b>	Defective M2C compressor body thermistor (R18T): Short (Master)		
<b>J3 - 42</b>	Defective M2C compressor body thermistor (R18T): Open (Sub)		
<b>J3 - 43</b>	Defective M2C compressor body thermistor (R18T): Short (Sub)		
<b>J3 - 47</b>	Defective M1C compressor body thermistor (R16T*): Open (Master) *In case of REYQ72 type, R18T		
<b>J3 - 48</b>	Defective M1C compressor body thermistor (R16T*): Short (Master) *In case of REYQ72 type, R18T		
<b>J3 - 49</b>	Defective M1C compressor body thermistor (R16T*): Open (Sub) *In case of REYQ72 type, R18T		
<b>J3 - 50</b>	Defective M1C compressor body thermistor (R16T*): Short (Sub) *In case of REYQ72 type, R18T		
<b>J3 - 56</b>	Discharge pipe warning (Master)		
<b>J3 - 57</b>	Discharge pipe warning (Sub)		
<b>J5 - 01</b>	Defective compressor suction thermistor (R19T) (Master)		Refer to the <b>J5</b> flowchart and make a diagnosis of the relevant thermistor of the relevant unit based on the Error code shown to the left.
<b>J5 - 03</b>	Defective compressor suction thermistor (R19T) (Sub)		
<b>J5 - 18</b>	Error detection of suction pipe before accumulator thermistor (R5T) (Master)		
<b>J5 - 19</b>	Error detection of suction pipe before accumulator thermistor (R5T) (Sub)		

Error code	Troubleshooting	
	Error Description	Diagnosis
<b>J6 - 01</b>	Defective heat exchanger right deicer thermistor (R8T) (Master)	Refer to the <b>J6</b> flowchart and make a diagnosis of the relevant thermistor of the relevant unit based on the Error code shown to the left.
<b>J6 - 02</b>	Defective heat exchanger right deicer thermistor (R8T) (Sub)	
<b>J6 - 08</b>	Defective heat exchanger right upper gas pipe thermistor (R2T) (Master)	
<b>J6 - 09</b>	Defective heat exchanger right upper gas pipe thermistor (R2T) (Sub)	
<b>J6 - 11</b>	Defective heat exchanger right lower gas pipe thermistor (R9T) (Master)	
<b>J6 - 12</b>	Defective heat exchanger right lower gas pipe thermistor (R9T) (Sub)	
<b>J6 - 14</b>	Error detection of heat exchanger right upper gas pipe thermistor (R2T) (Master)	
<b>J6 - 15</b>	Error detection of heat exchanger right upper gas pipe thermistor (R2T) (Sub)	
<b>J6 - 17</b>	Error detection of heat exchanger right lower gas pipe thermistor (R9T) (Master)	
<b>J6 - 18</b>	Error detection of heat exchanger right lower gas pipe thermistor (R9T) (Sub)	
<b>J6 - 22</b>	Defective heat exchanger left deicer thermistor (R23T) (Master)	
<b>J6 - 23</b>	Defective heat exchanger left deicer thermistor (R23T) (Sub)	
<b>J6 - 25</b>	Defective heat exchanger left gas pipe thermistor (R21T) (Master)	
<b>J6 - 26</b>	Defective heat exchanger left gas pipe thermistor (R21T) (Sub)	
<b>J6 - 33</b>	Error detection of heat exchanger left gas pipe thermistor (R21T) (Master)	Refer to the <b>J7</b> flowchart and make a diagnosis of the relevant thermistor of the relevant unit based on the Error code shown to the left.
<b>J6 - 34</b>	Error detection of heat exchanger left gas pipe thermistor (R21T) (Sub)	
<b>J7 - 01</b>	Defective receiver inlet thermistor (R10T) (Master)	
<b>J7 - 02</b>	Defective receiver inlet thermistor (R10T) (Sub)	
<b>J7 - 06</b>	Defective subcooling heat exchanger liquid pipe thermistor (R11T) (Master)	
<b>J7 - 07</b>	Defective subcooling heat exchanger liquid pipe thermistor (R11T) (Sub)	
<b>J7 - 17</b>	Standby for preventing fusible plug removal	
<b>J7 - 18</b>	Defective subcooling injection thermistor (R14T) (Master)	Refer to the <b>J8</b> flowchart and make a diagnosis of the relevant thermistor of the relevant unit based on the Error code shown to the left.
<b>J7 - 19</b>	Defective subcooling injection thermistor (R14T) (Sub)	
<b>J8 - 01</b>	Defective heat exchanger right upper liquid pipe thermistor (R6T) (Master)	
<b>J8 - 02</b>	Defective heat exchanger right upper liquid pipe thermistor (R6T) (Sub)	
<b>J8 - 08</b>	Defective heat exchanger right lower liquid pipe thermistor (R7T) (Master)	
<b>J8 - 09</b>	Defective heat exchanger right lower liquid pipe thermistor (R7T) (Sub)	
<b>J8 - 11</b>	Defective heat exchanger left liquid pipe thermistor (R22T) (Master)	
<b>J8 - 12</b>	Defective heat exchanger left liquid pipe thermistor (R22T) (Sub)	

Error code	Troubleshooting	
	Error Description	Diagnosis
<b>J9 - 01</b>	Defective subcooling heat exchanger gas pipe thermistor (R12T) (Master)	Refer to the <b>J9</b> flowchart and make a diagnosis of the relevant thermistor of the relevant unit based on the Error code shown to the left.
<b>J9 - 02</b>	Defective subcooling heat exchanger gas pipe thermistor (R12T) (Sub)	
<b>J9 - 08</b>	Error detection of subcooling heat exchanger gas pipe thermistor (R12T) (Master)	
<b>J9 - 09</b>	Error detection of subcooling heat exchanger gas pipe thermistor (R12T) (Sub)	
<b>J9 - 11</b>	Defective receiver gas purge thermistor (R4T) (Master)	
<b>J9 - 12</b>	Defective receiver gas purge thermistor (R4T) (Sub)	
<b>J9 - 17</b>	Defective electrical box air outlet thermistor (R3T) (Master)	
<b>J9 - 18</b>	Defective electrical box air outlet thermistor (R3T) (Sub)	
<b>JA - 06</b>	Defective high pressure sensor (S1NPH): Open (Master)	Refer to the <b>JA</b> flowchart and make a diagnosis of the relevant sensor based on the Error code shown to the left.
<b>JA - 07</b>	Defective high pressure sensor (S1NPH): Short (Master)	
<b>JA - 08</b>	Defective high pressure sensor (S1NPH): Open (Sub)	
<b>JA - 09</b>	Defective high pressure sensor (S1NPH): Short (Sub)	
<b>JC - 06</b>	Defective low pressure sensor (S1NPL): Open (Master)	Refer to the <b>JC</b> flowchart and make a diagnosis of the relevant sensor based on the Error code shown to the left.
<b>JC - 07</b>	Defective low pressure sensor (S1NPL): Short (Master)	
<b>JC - 08</b>	Defective low pressure sensor (S1NPL): Open (Sub)	
<b>JC - 09</b>	Defective low pressure sensor (S1NPL): Short (Sub)	
<b>L1 - 01</b>	IPM error: Compressor M1C (Master)	Refer to the <b>L1</b> flowchart and make a diagnosis of the relevant unit based on the Error code shown to the left.
<b>L1 - 02</b>	Defective current sensor 1: Compressor M1C (Master)	
<b>L1 - 03</b>	Defective current sensor 2: Compressor M1C (Master)	
<b>L1 - 04</b>	IGBT error: Compressor M1C (Master)	
<b>L1 - 05</b>	Jumper settings error (Master)	
<b>L1 - 07</b>	IPM error: Compressor M1C (Sub)	
<b>L1 - 08</b>	Defective current sensor 1: Compressor M1C (Sub)	
<b>L1 - 09</b>	Defective current sensor 2: Compressor M1C (Sub)	
<b>L1 - 10</b>	IGBT error: Compressor M1C (Sub)	
<b>L1 - 15</b>	Jumper settings error (Sub)	
<b>L1 - 17</b>	IPM error: Compressor M2C (Master)	
<b>L1 - 18</b>	Defective current sensor 1: Compressor M2C (Master)	
<b>L1 - 19</b>	Defective current sensor 2: Compressor M2C (Master)	
<b>L1 - 20</b>	IGBT error: Compressor M2C (Master)	
<b>L1 - 21</b>	DIP switch settings error (Master)	
<b>L1 - 22</b>	IPM error: Compressor M2C (Sub)	
<b>L1 - 23</b>	Defective current sensor 1: Compressor M2C (Sub)	
<b>L1 - 24</b>	Defective current sensor 2: Compressor M2C (Sub)	
<b>L1 - 25</b>	IGBT error: Compressor M2C (Sub)	
<b>L1 - 26</b>	DIP switch settings error (Sub)	
<b>L1 - 36</b>	Defective inverter PCB EEPROM: Compressor M1C (Master)	
<b>L1 - 37</b>	Defective inverter PCB EEPROM: Compressor M2C (Master)	
<b>L1 - 38</b>	Defective inverter PCB EEPROM: Compressor M1C (Sub)	
<b>L1 - 39</b>	Defective inverter PCB EEPROM: Compressor M2C (Sub)	
<b>L1 - 47</b>	15 V power supply error: Compressor M1C (Master)	
<b>L1 - 48</b>	15 V power supply error: Compressor M2C (Master)	
<b>L1 - 49</b>	15 V power supply error: Compressor M1C (Sub)	
<b>L1 - 50</b>	15 V power supply error: Compressor M2C (Sub)	

Error code	Troubleshooting	
	Error Description	Diagnosis
L2 - 01	Momentary power failure during test operation (Master)	Refer to the <b>L2</b> flowchart and make a diagnosis of the relevant unit based on the Error code shown to the left.
L2 - 02	Momentary power failure during test operation (Sub)	
L2 - 04	Switch ON the power supply (Master)	
L2 - 05	Switch ON the power supply (Sub)	
L4 - 01	Radiation fin temperature rise: Inverter PCB M1C (Master)	
L4 - 02	Radiation fin temperature rise: Inverter PCB M1C (Sub)	
L4 - 06	Radiation fin temperature rise: Fan M1F (Master)	
L4 - 07	Radiation fin temperature rise: Fan M2F (Master)	
L4 - 09	Radiation fin temperature rise: Inverter PCB M2C (Master)	
L4 - 10	Radiation fin temperature rise: Inverter PCB M2C (Sub)	
L4 - 12	Inverter radiation fin temperature rise abnormality M1C (Master)	
L4 - 13	Inverter radiation fin temperature rise abnormality M1C (Sub)	
L4 - 15	Inverter radiation fin temperature rise abnormality M2C (Master)	
L4 - 16	Inverter radiation fin temperature rise abnormality M2C (Sub)	
L4 - 18	Radiation fin temperature rise: Fan M1F (Sub)	
L4 - 19	Radiation fin temperature rise: Fan M2F (Sub)	
L5 - 03	Compressor M1C momentary overcurrent (Master)	Refer to the <b>L5</b> flowchart and make a diagnosis of the relevant unit based on the Error code shown to the left.
L5 - 05	Compressor M1C momentary overcurrent (Sub)	
L5 - 14	Compressor M2C momentary overcurrent (Master)	
L5 - 15	Compressor M2C momentary overcurrent (Sub)	
L8 - 03	Compressor M1C overcurrent (Master)	Refer to the <b>L8</b> flowchart and make a diagnosis of the relevant unit based on the Error code shown to the left.
L8 - 06	Compressor M1C overcurrent (Sub)	
L8 - 11	Compressor M2C overcurrent (Master)	
L8 - 12	Compressor M2C overcurrent (Sub)	
L9 - 01	Compressor M1C startup error (Master)	Refer to the <b>L9</b> flowchart and make a diagnosis of the relevant unit based on the Error code shown to the left.
L9 - 05	Compressor M1C startup error (Sub)	
L9 - 10	Compressor M2C startup error (Master)	
L9 - 11	Compressor M2C startup error (Sub)	
L9 - 13	Inverter output open phase M1C (Master)	
L9 - 14	Inverter output open phase M1C (Sub)	
L9 - 16	Inverter output open phase M2C (Master)	
L9 - 17	Inverter output open phase M2C (Sub)	
LC - 14	Transmission error (Between outdoor units, inverter PCB) (Master): M1C	Refer to the <b>LC</b> flowchart and make a diagnosis of the relevant unit based on the Error code shown to the left.
LC - 15	Transmission error (Between outdoor units, inverter PCB) (Sub): M1C	
LC - 19	Transmission error (Between outdoor units, fan PCB) (Master): M1F	
LC - 20	Transmission error (Between outdoor units, fan PCB) (Sub): M1F	
LC - 24	Transmission error (Between outdoor units, fan PCB) (Master): M2F	
LC - 25	Transmission error (Between outdoor units, fan PCB) (Sub): M2F	
LC - 30	Transmission error (Between outdoor units, inverter PCB) (Master): M2C	
LC - 31	Transmission error (Between outdoor units, inverter PCB) (Sub): M2C	
LC - 33	Transmission error (Between outdoor units, sub PCB) (Master)	
LC - 34	Transmission error (Between outdoor units, sub PCB) (Sub)	

Error code	Troubleshooting	
	Error Description	Diagnosis
P1 - 01	Inverter 1 power supply unbalanced voltage (Master)	Refer to the <b>P1</b> flowchart and make a diagnosis of the relevant unit based on the Error code shown to the left.
P1 - 02	Inverter 1 power supply unbalanced voltage (Sub)	
P1 - 07	Inverter 2 power supply unbalanced voltage (Master)	
P1 - 08	Inverter 2 power supply unbalanced voltage (Sub)	
P4 - 02	Defective fan M1F fin sensor (Master)	Refer to the <b>P4</b> flowchart and make a diagnosis of the relevant sensor based on the Error code shown to the left.
P4 - 03	Defective fan M2F fin sensor (Master)	
P4 - 09	Defective inverter diode bridge fin sensor M1C (Master)	
P4 - 10	Defective inverter diode bridge fin sensor M1C (Sub)	
P4 - 12	Defective inverter diode bridge fin sensor M2C (Master)	
P4 - 13	Defective inverter diode bridge fin sensor M2C (Sub)	
P4 - 15	Defective fan M1F fin sensor (Sub)	
P4 - 16	Defective fan M2F fin sensor (Sub)	
PJ - 04	Incorrect type of inverter PCB M1C (Master)	Refer to the <b>PJ</b> flowchart and make a diagnosis of the relevant unit based on the Error code shown to the left.
PJ - 05	Incorrect type of inverter PCB M1C (Sub)	
PJ - 09	Incorrect type of fan PCB (Master): M1F	
PJ - 10	Incorrect type of fan PCB (Master): M2F	
PJ - 12	Incorrect type of inverter PCB M2C (Master)	
PJ - 13	Incorrect type of inverter PCB M2C (Sub)	
PJ - 15	Incorrect type of fan PCB (Sub): M1F	
PJ - 17	Incorrect type of fan PCB (Sub): M2F	
U0 - 05	Refrigerant shortage warning (cooling)	Refer to the <b>U0</b> flowchart and make a diagnosis of the relevant unit based on the Error code shown to the left.
U0 - 06	Refrigerant shortage warning (heating)	
U1 - 01	Reverse phase/open phase of power supply (Master)	Refer to the <b>U1</b> flowchart and make a diagnosis of the relevant unit based on the Error code shown to the left.
U1 - 04	Reverse phase/open phase of power supply (when power ON) (Master)	
U1 - 05	Reverse phase/open phase of power supply (Sub)	
U1 - 06	Reverse phase/open phase of power supply (when power ON) (Sub)	
U1 - 19	Power supply frequency issue (Master)	
U1 - 20	Power supply frequency issue (Sub)	
U2 - 01	Shortage of inverter 1 power supply voltage (Master)	Make a diagnosis of the relevant unit based on the following.
U2 - 02	Open phase of inverter 1 power supply (Master)	
U2 - 03	Defective capacitor in inverter 1 main circuit (Master)	
U2 - 08	Shortage of inverter 1 power supply voltage (Sub)	<p><b>Shortage of power supply voltage</b> If the other units detect shortage of power supply voltage, power supply voltage during operation may be unstable. Check the power supply condition. If a particular unit detects the error, operation of 52C may be defective. Follow the <b>U2</b> flowchart.</p> <p><b>Open phase of power supply</b> The wiring between power supply and inverter PCB may be disconnected. Check that power supply is connected to terminal block, terminal block is connected to PCB without broken wire or disconnection, and reactor wiring is secured. If no abnormality is found, follow the <b>U2</b> flowchart.</p> <p><b>Defective capacitor in main circuit</b> P-N on the inverter PCB (electrolytic capacitor, power module) may be damaged and short circuited. Operation of current limiting relay may be defective or the wiring between the reactor and PCB may be disconnected. Measure the resistance between P-N on the inverter PCB and check for short circuit. If no abnormality is found, follow the <b>U2</b> flowchart.</p>
U2 - 09	Open phase of inverter 1 power supply (Sub)	
U2 - 10	Defective capacitor in inverter 1 main circuit (Sub)	
U2 - 22	Shortage of inverter 2 power supply voltage (Master)	
U2 - 23	Open phase of inverter 2 power supply (Master)	
U2 - 24	Defective capacitor in inverter 2 main circuit (Master)	
U2 - 25	Shortage of inverter 2 power supply voltage (Sub)	
U2 - 26	Open phase of inverter 2 power supply (Sub)	
U2 - 27	Defective capacitor in inverter 2 main circuit (Sub)	
U2 - 36	Fan motor 1 undervoltage (Master)	
U2 - 37	Fan motor 2 undervoltage (Master)	
U2 - 38	Fan motor 1 undervoltage (Sub)	
U2 - 39	Fan motor 2 undervoltage (Sub)	

Error code	Troubleshooting	
	Error Description	Diagnosis
<b>U3 - 02</b>	Initial installation warning	Refer to the <b>U3</b> flowchart and make a diagnosis of the relevant unit based on the Error code shown to the left.
<b>U3 - 03</b>	Test operation not conducted	
<b>U3 - 04</b>	Abnormal end of test operation	
<b>U3 - 05</b>	Premature end of test operation during initial transmission error	
<b>U3 - 06</b>	Premature end of test operation during normal transmission error	
<b>U3 - 07</b>	Premature end of test operation due to transmission error of either unit	
<b>U3 - 08</b>	Premature end of test operation due to transmission error of all units	
<b>U4 - 01</b>	Transmission error between indoor units and outdoor units	Refer to the <b>U4</b> flowchart and make a diagnosis of the relevant unit based on the Error code shown to the left.
<b>U4 - 03</b>	Transmission error between indoor unit and system	
<b>U4 - 09</b>	Transmission error between indoor units and outdoor units	
<b>U4 - 10</b>	Transmission error between indoor units and outdoor units	
<b>U4 - 11</b>	Transmission error between indoor units and outdoor units	
<b>U4 - 12</b>	Transmission error between indoor units and outdoor units	
<b>U4 - 13</b>	Transmission error between indoor units and outdoor units	
<b>U4 - 14</b>	Transmission error between indoor units and outdoor units	
<b>U7 - 01</b>	Error when external control adaptor for outdoor unit is installed	Refer to the <b>U7</b> flowchart and make a diagnosis of the relevant unit based on the Error code shown to the left.
<b>U7 - 02</b>	Warning when external control adaptor for outdoor unit is installed	
<b>U7 - 03</b>	Transmission error between Master and Sub units	
<b>U7 - 05</b>	Multi system error	
<b>U7 - 06</b>	Error in address settings of Sub unit	
<b>U7 - 07</b>	Connection of four or more outdoor units in the same system	
<b>U7 - 11</b>	Error in indoor unit connection capacity for test operation	
<b>U7 - 24</b>	Defective Branch Selector unit external control adaptor	
<b>U9 - 01</b>	Other indoor units abnormality	Refer to the <b>U9</b> flowchart and make a diagnosis of the relevant unit based on the Error code shown to the left.
<b>UA - 17</b>	Connection of excessive indoor units	Refer to the <b>UA</b> flowchart and make a diagnosis of the relevant unit based on the Error code shown to the left.
<b>UA - 18</b>	Connection of wrong models of indoor units	
<b>UA - 20</b>	Improper combination of outdoor units	
<b>UA - 21</b>	Connection error	
<b>UA - 23</b>	Connection of excessive Branch Selector units	
<b>UA - 25</b>	Defective connection between outdoor unit and Branch Selector unit	
<b>UA - 26</b>	Defective connection between Branch Selector units	
<b>UA - 27</b>	Error of the number of connected Branch Selector and outdoor units	
<b>UA - 28</b>	Wrong Branch Selector unit model connected	
<b>UA - 31</b>	Multi-unit combination error	
<b>UA - 53</b>	Branch Selector unit DIP switch settings error (Centralized type)	
<b>UF - 01</b>	Wrong wiring check error	Refer to the <b>UF</b> flowchart and make a diagnosis of the relevant unit based on the Error code shown to the left.
<b>UF - 05</b>	Defective stop valve for test operation	
<b>UF - 18</b>	Wrong wiring check error for wrong wiring automatic operation	
<b>UH - 01</b>	Wiring error	Refer to the <b>UH</b> flowchart and make a diagnosis of the relevant unit based on the Error code shown to the left.

### 3.3 Prediction Codes

#### Prediction Code List

Prediction code	Seven-segment display				Description	Possible cause	Tech tips
	Product type code	Prediction code	Prediction sub code	AirNet address display flag			
10A-##	--1	001	-##	—	Compressor overcurrent prediction	Error code L5, L8 Same as L8	Refer to L5, L8 troubleshooting
12A-##	--1	201	-##	—	EVM1 refrigerant leakage prediction (during evaporation)	<ul style="list-style-type: none"> <li>■ Tf sensor failure</li> <li>■ Tg sensor failure</li> <li>■ LP sensor failure</li> <li>■ EVM1 coil failure</li> <li>■ EVM1 failure</li> </ul>	Tg: Refer to J9 troubleshooting. LP: Refer to JC troubleshooting. Electronic expansion valve coil: Refer to E9 troubleshooting If the above error is not seen, replace EVM1.
12D-##	--1	204	-##	—	EVM2 refrigerant leakage prediction (during evaporation)	<ul style="list-style-type: none"> <li>■ Tf sensor failure</li> <li>■ Tg sensor failure</li> <li>■ LP sensor failure</li> <li>■ EVM2 coil failure</li> <li>■ EVM2 failure</li> </ul>	Tg: Refer to J9 troubleshooting. LP: Refer to JC troubleshooting. Electronic expansion valve coil: Refer to E9 troubleshooting If the above error is not seen, replace EVM2.
12G-##	--1	207	-##	—	EVM3 refrigerant leakage prediction (during evaporation)	<ul style="list-style-type: none"> <li>■ Tf sensor failure</li> <li>■ Tg sensor failure</li> <li>■ LP sensor failure</li> <li>■ EVM3 coil failure</li> <li>■ EVM3 failure</li> </ul>	Tg: Refer to J9 troubleshooting. LP: Refer to JC troubleshooting. Electronic expansion valve coil: Refer to E9 troubleshooting If the above error is not seen, replace EVM3.
14A-##	--1	401	-##	—	Four way valve (20SA1) intermediate stop prediction	<ul style="list-style-type: none"> <li>■ HP sensor failure</li> <li>■ LP sensor failure</li> <li>■ Four way valve coil failure</li> <li>■ Four way valve failure</li> </ul>	HP: Refer to JA troubleshooting. LP: Refer to JC troubleshooting. If the above error is not seen, compressor, four way valve coil, or four way valve is defective.
14B-##	--1	402	-##	—	Four way valve (20SA1) switching failure prediction	<ul style="list-style-type: none"> <li>■ HP sensor failure</li> <li>■ LP sensor failure</li> <li>■ Tf sensor failure</li> <li>■ Tg sensor failure</li> <li>■ Four way valve coil failure</li> <li>■ Four way valve failure</li> </ul>	HP: Refer to JA troubleshooting. LP: Refer to JC troubleshooting. Tg: Refer to J9 troubleshooting. Tf: Refer to J8 troubleshooting. Ta: Refer to H9 troubleshooting. If the above error is not seen, compressor, four way valve coil, or four way valve is defective.
14C-##	--1	403	-##	—	Four way valve (20SA2) intermediate stop prediction	<ul style="list-style-type: none"> <li>■ HP sensor failure</li> <li>■ LP sensor failure</li> <li>■ Four way valve coil failure</li> <li>■ Four way valve failure</li> </ul>	HP: Refer to JA troubleshooting. LP: Refer to JC troubleshooting. If the above error is not seen, compressor, four way valve coil, or four way valve is defective.
14D-##	--1	404	-##	—	Four way valve (20SA2) switching failure prediction	<ul style="list-style-type: none"> <li>■ HP sensor failure</li> <li>■ LP sensor failure</li> <li>■ Tf sensor failure</li> <li>■ Tg sensor failure</li> <li>■ Four way valve coil failure</li> <li>■ Four way valve failure</li> </ul>	HP: Refer to JA troubleshooting. LP: Refer to JC troubleshooting. Tg: Refer to J9 troubleshooting. Tf: Refer to J8 troubleshooting. Ta: Refer to H9 troubleshooting. If the above error is not seen, compressor, four way valve coil, or four way valve is defective.
14E-##	--1	405	-##	—	Four way valve (20SA3) intermediate stop prediction	<ul style="list-style-type: none"> <li>■ HP sensor failure</li> <li>■ LP sensor failure</li> <li>■ Four way valve coil failure</li> <li>■ Four way valve failure</li> </ul>	HP: Refer to JA troubleshooting. LP: Refer to JC troubleshooting. If the above error is not seen, compressor, four way valve coil, or four way valve is defective.
14F-##	--1	406	-##	—	Four way valve (20SA3) switching failure prediction	<ul style="list-style-type: none"> <li>■ HP sensor failure</li> <li>■ LP sensor failure</li> <li>■ Tf sensor failure</li> <li>■ Tg sensor failure</li> <li>■ Four way valve coil failure</li> <li>■ Four way valve failure</li> </ul>	HP: Refer to JA troubleshooting. LP: Refer to JC troubleshooting. Tg: Refer to J9 troubleshooting. Tf: Refer to J8 troubleshooting. Ta: Refer to H9 troubleshooting. If the above error is not seen, compressor, four way valve coil, or four way valve is defective.
14G-##	--1	407	-##	—	Four way valve (20SB) intermediate stop prediction	<ul style="list-style-type: none"> <li>■ HP sensor failure</li> <li>■ LP sensor failure</li> <li>■ Four way valve coil failure</li> <li>■ Four way valve failure</li> </ul>	HP: Refer to JA troubleshooting. LP: Refer to JC troubleshooting. If the above error is not seen, compressor, four way valve coil, or four way valve is defective.
14H-##	--1	408	-##	—	Four way valve (20SB) switching failure prediction	<ul style="list-style-type: none"> <li>■ HP sensor failure</li> <li>■ LP sensor failure</li> <li>■ TsA sensor failure</li> <li>■ Ts sensor failure</li> <li>■ Th1 sensor failure</li> <li>■ Th2 sensor failure</li> <li>■ Th3 sensor failure</li> <li>■ Four way valve coil failure</li> <li>■ Four way valve failure</li> </ul>	HP: Refer to JA troubleshooting. LP: Refer to JC troubleshooting. TsA: Refer to J5 troubleshooting. Ts: Refer to J5 troubleshooting. Th1: Refer to C9 troubleshooting. Th2: Refer to C4 troubleshooting. Th3: Refer to C5 troubleshooting. If the above error is not seen, compressor, four way valve coil, or four way valve is defective.
16A-##	--1	601	-##	—	Discharge pipe thermistor failure prediction (Tdi)	■ Tdi sensor failure	Refer to J3 troubleshooting.
16B-##	--1	602	-##	—	Compressor body thermistor failure prediction (Ti)	■ Ti sensor failure	Refer to J3 troubleshooting.
16C-##	--1	603	-##	—	Outdoor air thermistor failure prediction (Ta)	■ Ta sensor failure	Refer to H9 troubleshooting.
16D-##	--1	604	-##	—	Heat exchanger deicer thermistor failure prediction (Tb1)	■ Tb sensor failure	Refer to J6 troubleshooting.
16G-##	--1	607	-##	—	Subcooling heat exchanger gas pipe thermistor failure prediction (Tsh)	■ Tsh sensor failure	Refer to J9 troubleshooting.
16H-##	--1	608	-##	—	Subcooling heat exchanger liquid pipe thermistor failure prediction (Tsc)	■ Tsc sensor failure	Refer to J7 troubleshooting.



Prediction code	Seven-segment display				Description	Possible cause	Tech tips
	Product type code	Prediction code	Prediction sub code	AirNet address display flag			
16I-##	__ 1	6 0 9	- # #	—	Heat exchanger liquid pipe thermistor 1 failure prediction (Tf1)	■ Tf1 sensor failure	Refer to <b>J8</b> troubleshooting.
16J-##	__ 1	6 1 0	- # #	—	Heat exchanger liquid pipe thermistor 2 failure prediction (Tf2)	■ Tf2 sensor failure	Refer to <b>J8</b> troubleshooting.
16L-##	__ 1	6 1 2	- # #	—	Compressor suction thermistor failure prediction (Ts)	■ Ts sensor failure	Refer to <b>J5</b> troubleshooting.
16M-##	__ 1	6 1 3	- # #	—	Accumulator inlet thermistor failure prediction (TsA)	■ TsA sensor failure	Refer to <b>J5</b> troubleshooting.
16N-##	__ 1	6 1 4	- # #	—	Receiver gas purge thermistor failure prediction (Tgi)	■ Tgi sensor failure	Refer to <b>J9</b> troubleshooting.
16O-##	__ 1	6 1 5	- # #	—	Liquid pipe thermistor failure prediction (TL)	■ TL sensor failure	Refer to <b>J7</b> troubleshooting.
16P-##	__ 1	6 1 6	- # #	—	Heat exchanger gas pipe thermistor 1 failure prediction (Tg1)	■ Tg1 sensor failure	Refer to <b>J6</b> troubleshooting.
16Q-##	__ 1	6 1 7	- # #	—	Heat exchanger gas pipe thermistor 2 failure prediction (Tg2)	■ Tg2 sensor failure	Refer to <b>J6</b> troubleshooting.
16S-##	__ 1	6 1 9	- # #	—	Subcooling injection thermistor failure prediction (Tm)	■ Tm sensor failure	Refer to <b>J7</b> troubleshooting.
16U-##	__ 1	6 2 1	- # #	—	Electrical box air outlet thermistor failure prediction (Tjeva)	■ Tjeva sensor failure	Refer to <b>J9</b> troubleshooting.
16V-##	__ 1	6 2 2	- # #	—	High pressure sensor failure prediction (HP)	■ HP sensor failure	Refer to <b>JA</b> troubleshooting.
16W-##	__ 1	6 2 3	- # #	—	Low pressure sensor failure prediction (LP)	■ LP sensor failure	Refer to <b>JC</b> troubleshooting.
20A-##	__ 2	0 0 1	- # #	—	Heat exchanger freeze up prediction	■ Tb sensor failure ■ Freeze	Melt frost on the outdoor heat exchanger.
30A-##	__ 3	0 0 1	###	__ #	Indoor unit electronic expansion valve leak (evaporator) prediction	■ Tb sensor failure ■ Indoor leakage	Th1: Refer to <b>C9</b> troubleshooting. Th2: Refer to <b>C4</b> troubleshooting. Th3: Refer to <b>C5</b> troubleshooting. LP: Refer to <b>JC</b> troubleshooting. If the above error is not seen, the corresponding indoor electronic expansion valve and expansion valve coil can be considered.
31A-##	__ 3	1 0 1	###	__ #	Indoor unit thermistor failure prediction (Th1)	■ Th1 sensor failure ■ Th2 sensor failure ■ Th3 sensor failure	Th1: Refer to <b>C9</b> troubleshooting. Th2: Refer to <b>C4</b> troubleshooting. Th3: Refer to <b>C5</b> troubleshooting.
31B-##	__ 3	1 0 2	###	__ #	Indoor unit thermistor failure prediction (Th2)	■ Th1 sensor failure ■ Th2 sensor failure ■ Th3 sensor failure	Th1: Refer to <b>C9</b> troubleshooting. Th2: Refer to <b>C4</b> troubleshooting. Th3: Refer to <b>C5</b> troubleshooting.
31C-##	__ 3	1 0 3	###	__ #	Indoor unit thermistor failure prediction (Th3)	■ Th1 sensor failure ■ Th2 sensor failure ■ Th3 sensor failure	Th1: Refer to <b>C9</b> troubleshooting. Th2: Refer to <b>C4</b> troubleshooting. Th3: Refer to <b>C5</b> troubleshooting.
43A-##	__ 4	3 0 1	- 0 0	—	Refrigerant shortage and refrigerant leakage prediction (detected during non-operation)	■ HP sensor failure ■ Refrigerant leak or shortage	HP: Refer to <b>JA</b> troubleshooting. If the above error is not seen, refrigerant shortage or leakage from the system can be considered. (*)
43B-##	__ 4	3 0 2	- 0 0	—	Refrigerant shortage and refrigerant leakage prediction (detected during cooling operation)	■ Refrigerant leak or shortage	Check for refrigerant leakage. Check for refrigerant shortage. (*)
43C-##	__ 4	3 0 3	- 0 0	—	Refrigerant shortage and refrigerant leakage prediction (detected during cooling and heating simultaneous operation)	■ Refrigerant leak or shortage	Check for refrigerant leakage. Check for refrigerant shortage. (*)
43D-##	__ 4	3 0 4	- 0 0	—	Refrigerant shortage and refrigerant leakage prediction (detecting during heating operation)	■ Refrigerant leak or shortage	Check for refrigerant leakage. Check for refrigerant shortage. (*)
47A-##	__ 4	7 0 1	- 0 0	—	Outdoor-indoor communication failure prediction	■ Outdoor unit control PCB failure ■ Indoor PCB failure ■ Outdoor-indoor communication line failure	—

\* Depending on operating condition, partial refrigerant shortage may be detected even though correct refrigerant amount is in the system. Please refer to **Refrigerant Shortage Check** on page 457 for the analysis.

Prediction Code Detail Information

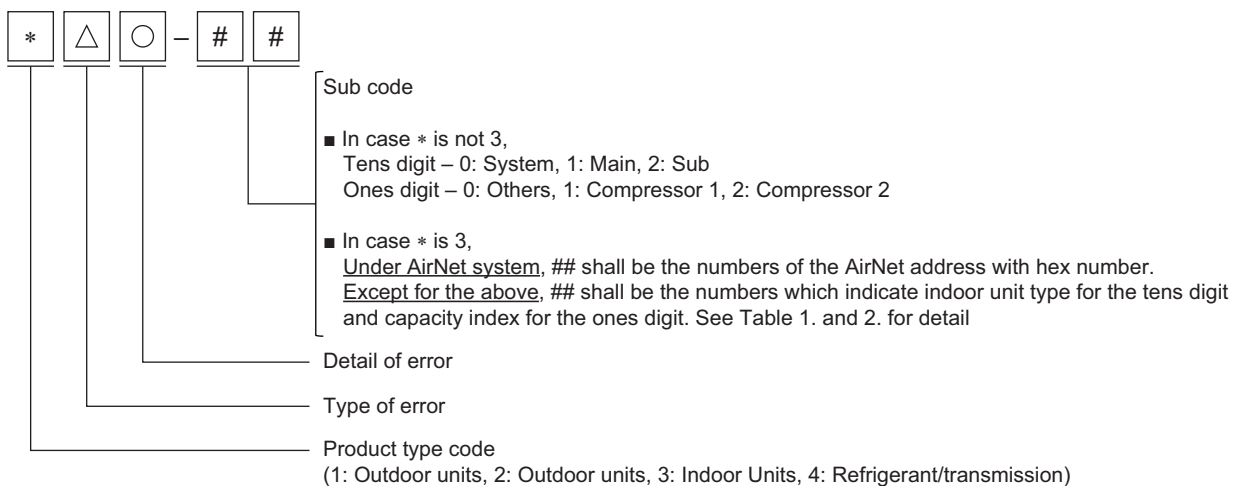

Table 1.

Tens digit	Applicable Model
0	Other
1	FXMQ-PB, FXMQ-TB, FXMQ-TA
2	FXAQ-P
3	FXZQ-TA
4	FXSQ-TA, FXSQ-TB
5	FXFQ-T, FXFQ-AA
6	FXDQ-M
7	FXEQ-P
8	FXLQ-M
9	FXUQ-P, FXUQ-PA

Table 2.

Ones digit	Capacity index
0	Other
1	05, 07
2	09
3	12, 15
4	18
5	24
6	30
7	36, 48
8	54
9	72, 96

**Prediction Code Detail Information by Seven-segment Display in Monitor Mode**

Push BS2
Push BS2
Push BS2

Product type digit			Prediction code			Prediction sub code			AirNet address display flag		
			Type of error	Detail of error							
SEG1	SEG2	SEG3	SEG1	SEG2	SEG3	SEG1	SEG2	SEG3	SEG1	SEG2	SEG3
		*	△	○	○	#	#	#			□

Eg.)

■ In case \* is not 3,

Push BS2
Push BS2

Product type digit			Prediction code			Prediction sub code			AirNet address display flag		
			Type of error	Detail of error							
SEG1	SEG2	SEG3	SEG1	SEG2	SEG3	SEG1	SEG2	SEG3	SEG1	SEG2	SEG3
		2	0	0	1	-	1	2			

Alphabet of prediction code is converted to the number. (A:1, B:2, C:3, ...)

■ In case \* is 3 with AirNet address display flag 1,

Push BS2
Push BS2
Push BS2

Product type digit			Prediction code			Prediction sub code			AirNet address display flag		
			Type of error	Detail of error							
SEG1	SEG2	SEG3	SEG1	SEG2	SEG3	SEG1	SEG2	SEG3	SEG1	SEG2	SEG3
		3	1	0	1	1	1	1			1

### shall be the numbers of the AirNet address with decimal number.

■ In case \* is 3 with AirNet address display flag 0,

Push BS2
Push BS2
Push BS2

Product type digit			Prediction code			Prediction sub code			AirNet address display flag		
			Type of error	Detail of error							
SEG1	SEG2	SEG3	SEG1	SEG2	SEG3	SEG1	SEG2	SEG3	SEG1	SEG2	SEG3
		3	1	0	3		1	5			0

### shall be the numbers which indicate indoor unit type on SEG2 and capacity index on SEG3. See Table 1 and 2 for details.

## 3.4 External Protection Device Abnormality

### 3.4.1 External Protection Device Abnormality

<b>Applicable Models</b>	All indoor unit models
<b>Error Code</b>	<b>A0</b>
<b>Method of Error Detection</b>	Detects open or short circuit between external input terminals in indoor unit.
<b>Error Decision Conditions</b>	When an open circuit occurs between external input terminals with the remote controller set to external ON/OFF terminal.
<b>Supposed Causes</b>	<ul style="list-style-type: none"> <li>■ Activation of external protection device</li> <li>■ Improper field setting</li> <li>■ Defective indoor unit control PCB</li> </ul>

#### Troubleshooting



**Caution**

Be sure to turn off the power switch before connecting or disconnecting connectors, or parts may be damaged.

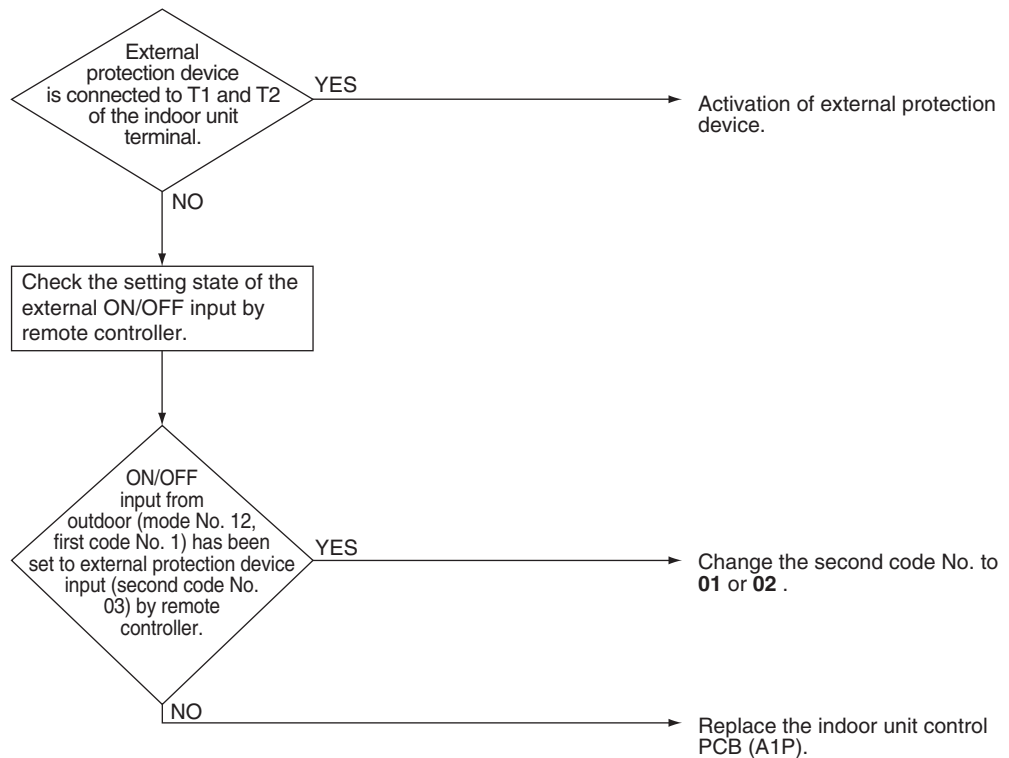

### 3.4.2 External Protection Device Abnormality (FXTQ-TA, FXTQ-TB, CXTQ-TA Only)

**Applicable Models** FXTQ-TA, FXTQ-TB, CXTQ-TA

**Error Code** **A0-01**

**Method of Error Detection** Detect open or short circuit between external input terminals in indoor unit.

**Error Decision Conditions** When an open circuit occurs between external input terminals.

**Supposed Causes**

- Activation of external protection device
- Defective indoor unit PCB
- Indoor unit fuse blown
- 24 VAC power is not supplied to TH2 and TR2 terminals (FXTQ-TA, FXTQ-TB) or R and C terminals (CXTQ-TA) on the indoor unit PCB.

#### Troubleshooting



**Caution**

Be sure to turn off the power switch before connecting or disconnecting connectors, or parts may be damaged.

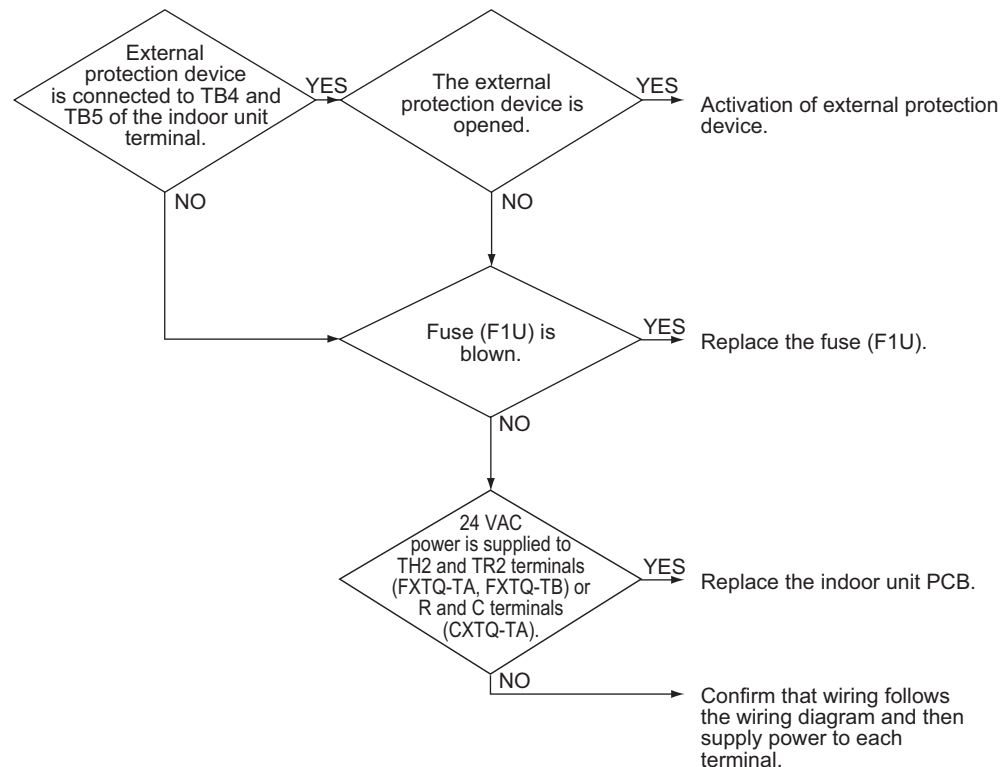

### 3.5 Indoor Unit Control PCB Abnormality

<b>Applicable Models</b>	All indoor unit models
<b>Error Code</b>	<b>A1</b>
<b>Method of Error Detection</b>	Check data from EEPROM.
<b>Error Decision Conditions</b>	When data could not be correctly received from the EEPROM EEPROM : Type of nonvolatile memory. Maintains memory contents even when the power supply is turned OFF.
<b>Supposed Causes</b>	<ul style="list-style-type: none"> <li>■ Defective indoor unit control PCB</li> <li>■ External factor (Noise, etc.)</li> </ul>

**Troubleshooting**

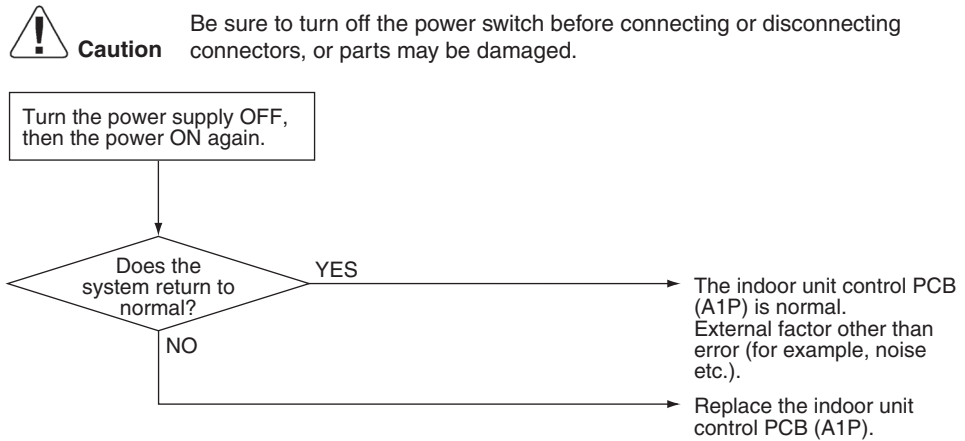

## 3.6 Drain Level Control System Abnormality

**Applicable Models** FXFQ-AA, FXFQ-T, FXZQ-TA, FXZQ-TB, FXUQ-P, FXUQ-PA, FXEQ-P, FXDQ-M, FXSQ-TA, FXSQ-TB, FXMQ-PB, FXMQ-TB, FXMQ-TA (Option)

**Error Code** **A3**

**Method of Error Detection** By float switch OFF detection

**Error Decision Conditions** When rise of water level is not a condition and the float switch goes OFF.

- Supposed Causes**
- 208-230 V power supply is not provided
  - Defective float switch or short circuit connector
  - Defective drain pump
  - Drain clogging, upward slope, etc.
  - Defective indoor unit control PCB
  - Loose connection of connector

### Troubleshooting



**Caution**

Be sure to turn off the power switch before connecting or disconnecting connectors, or parts may be damaged.

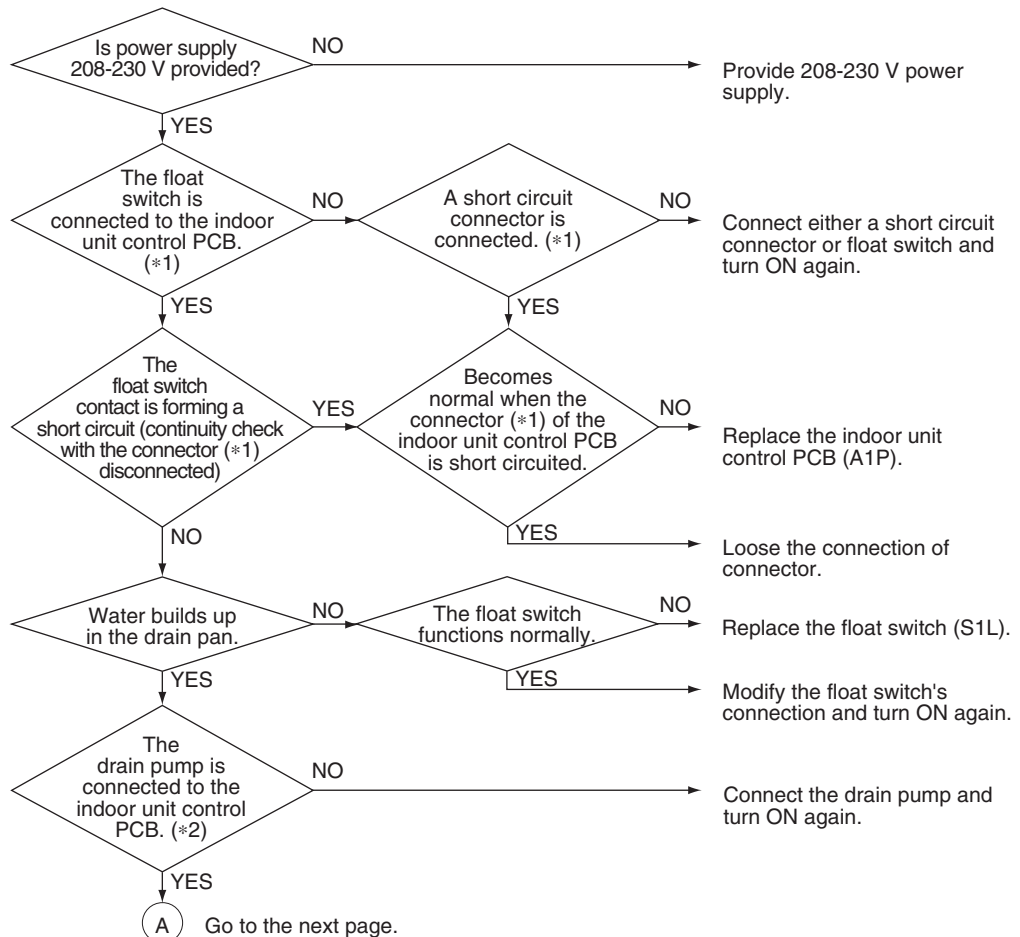

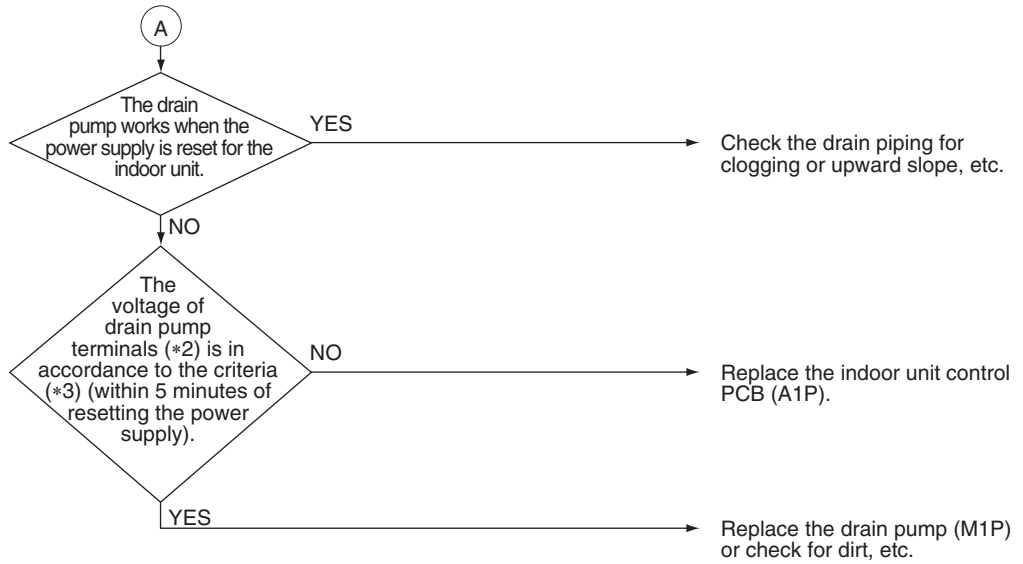

**i** Note(s)

Model	*1: Float switch (S1L) / short circuit connector	*2: Drain pump (M1P) connector	*3: Drain pump (M1P) voltage	Note
FXFQ-AA	X15A	X25A	13 VDC	—
FXFQ-T	X15A	X10A	13 VDC	—
FXZQ-TA	X15A	X102A	13 VDC	—
FXZQ-TB	X15A	X25A	13 VDC	—
FXUQ-P	X15A	X25A	13 VDC	—
FXUQ-PA	X15A	X25A	13 VDC	—
FXEQ-P	X15A	X25A	13 VDC	—
FXDQ-M	X8A	X25A	220-240 VAC	—
FXSQ-TA	X15A	X25A	13 VDC	—
FXSQ-TB	X15A	X25A	13 VDC	—
FXMQ-PB	X15A	X25A	220-240 VAC	—
FXMQ-TB	X15A	X25A	13 VDC	—
FXMQ-TA	X15A	X25A	13 VDC	Option



## 3.7 Indoor Fan Motor Lock, Overload

<b>Applicable Models</b>	FXFQ-T, FXZQ-TA, FXZQ-TB, FXUQ-P, FXUQ-PA, FXEQ-P, FXSQ05-48TA, FXSQ05-48TB, FXMQ07-12PB, FXMQ15-24TB, FXAQ-P
<b>Error Code</b>	<b>A6</b>
<b>Method of Error Detection</b>	Abnormal fan revolutions are detected by a signal output from the fan motor.
<b>Error Decision Conditions</b>	When the fan revolutions do not increase
<b>Supposed Causes</b>	<ul style="list-style-type: none"> <li>■ Broken wires in, short circuit of, or disconnection of connectors from the fan motor harness</li> <li>■ Defective fan motor (Broken wires or defective insulation)</li> <li>■ Abnormal signal output from the fan motor (defective circuit)</li> <li>■ Defective indoor unit control PCB</li> <li>■ Instantaneous disturbance in the power supply voltage</li> <li>■ Fan motor lock (Due to motor or external causes)</li> <li>■ The fan does not rotate due to foreign matter blocking the fan.</li> <li>■ Disconnection of the connector between the indoor unit control PCB (A1P) and the fan PCB (A2P) (FXSQ05-48TA, FXSQ05-48TB, FXMQ07-12PB, FXMQ15-24TB only)</li> <li>■ Blowout of the fuse connected between the indoor unit PCB and the fan motor harness</li> </ul>

Troubleshooting



**Caution** Be sure to turn off the power switch before connecting or disconnecting connectors, or parts may be damaged.

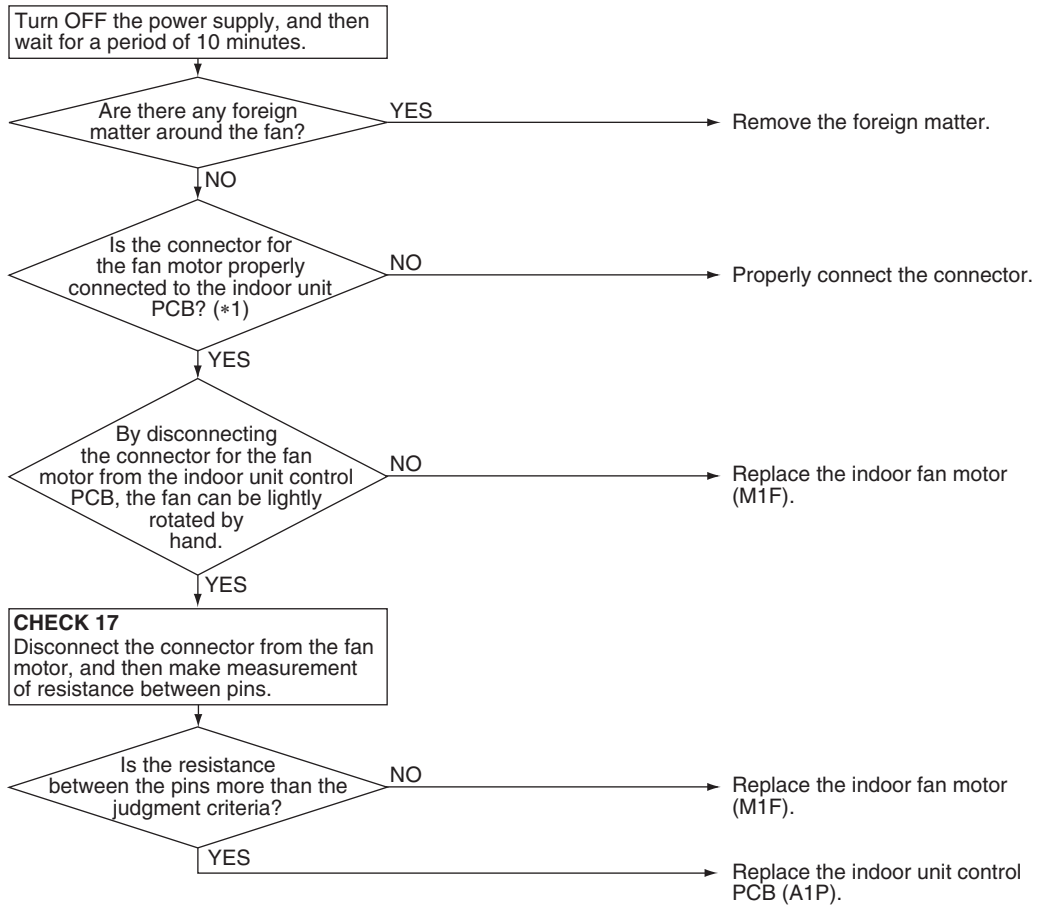

**Note(s)**

\*1: Check the following connectors.

Model	Connector	PCB
FXFQ-T	X20A, Relay connector	A1P
FXZQ-TA	X20A, Relay connector	A1P
FXZQ-TB	X20A, Relay connector	A1P
FXUQ-P	X20A, Relay connector	A1P
FXUQ-PA	X20A, Relay connector	A1P
FXEQ-P	X20A	A1P
FXSQ05-48TA	X8A	A2P
FXSQ05-48TB	X8A	A2P
FXMQ07-12PB	X8A	A2P
FXMQ15-24TB	X8A	A2P
FXAQ-P	X20A	A1P



**Reference**

**CHECK 17** Refer to page 468.

## 3.8 Indoor Fan Motor Abnormality

### 3.8.1 Indoor Fan Motor Abnormality (FXFQ-AA Models)

**Applicable Models** FXFQ-AA

**Error Code** **A6**

**Method of Error Detection**

- Detection from the current flow on the PCB (A1P)
- Detection from the current flow on the PCB when the fan motor starting operation

**Error Decision Conditions**

- An overcurrent flows
- The rotation speed is less than a certain level for 6 seconds.
- A position error in the fan rotor continues for 5 seconds or more.

**Supposed Causes**

- Fan does not rotate due to clogged foreign matter.
- Disconnection, short circuit, or loose connection of the harness of the fan motor
- Fan motor lock (motor-related or external factors)
- Defective fan motor (disconnection or insulation failure)
- Defective indoor unit PCB

#### Troubleshooting

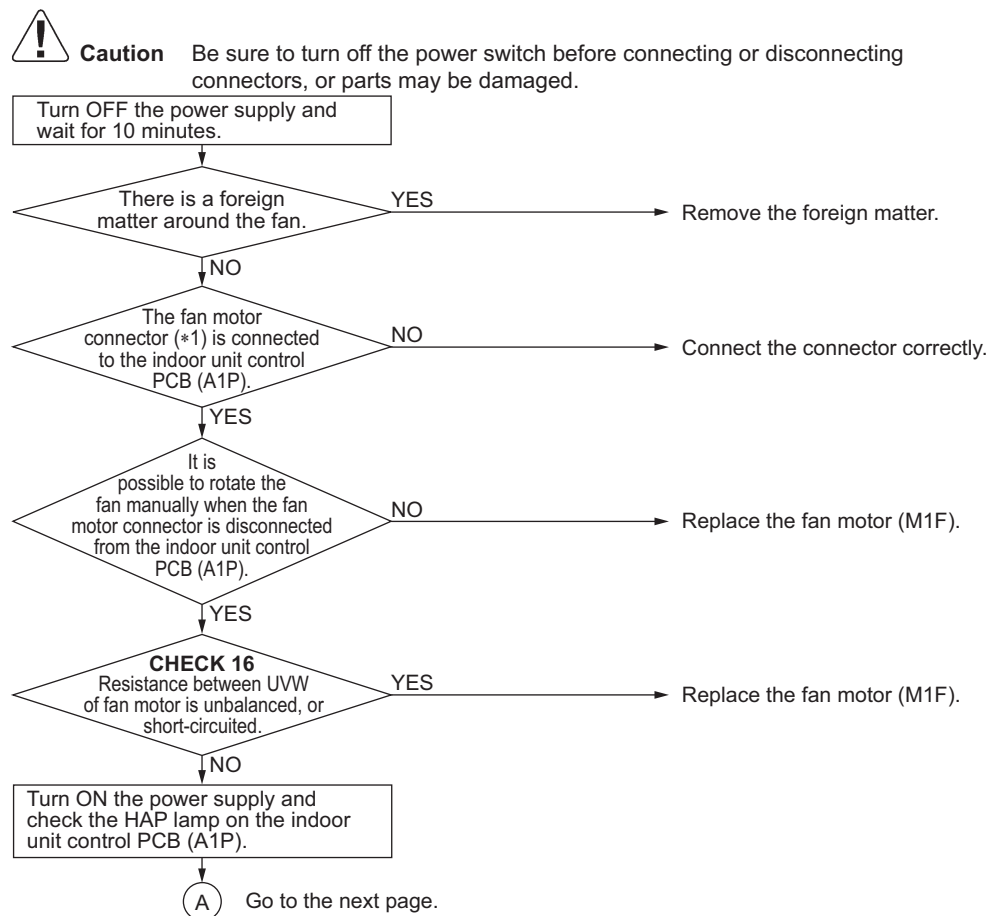

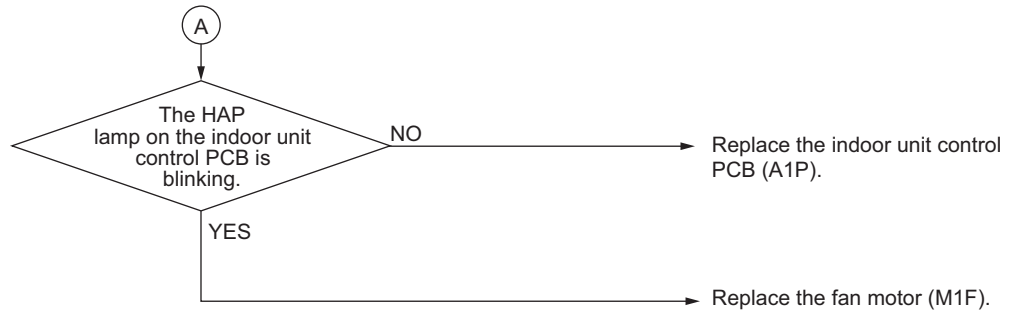

\*1. Check also if the relay connector between the indoor unit control PCB and the fan motor are correctly connected.



Reference

**CHECK 16** Refer to page 466.

### 3.8.2 Indoor Fan Motor Abnormality (FXDQ-M, FXHQ-M Models)

**Applicable Models** FXDQ-M, FXHQ-M

**Error Code** **A6**

**Method of Error Detection** This error is detected if there is no revolution detection signal output from the fan motor.

**Error Decision Conditions** When no revolutions can be detected even at the maximum output voltage to the fan

**Supposed Causes**

- Defective indoor fan motor
- Broken wires
- Defective contact

#### Troubleshooting



**Caution**

Be sure to turn off the power switch before connecting or disconnecting connectors, or parts may be damaged.

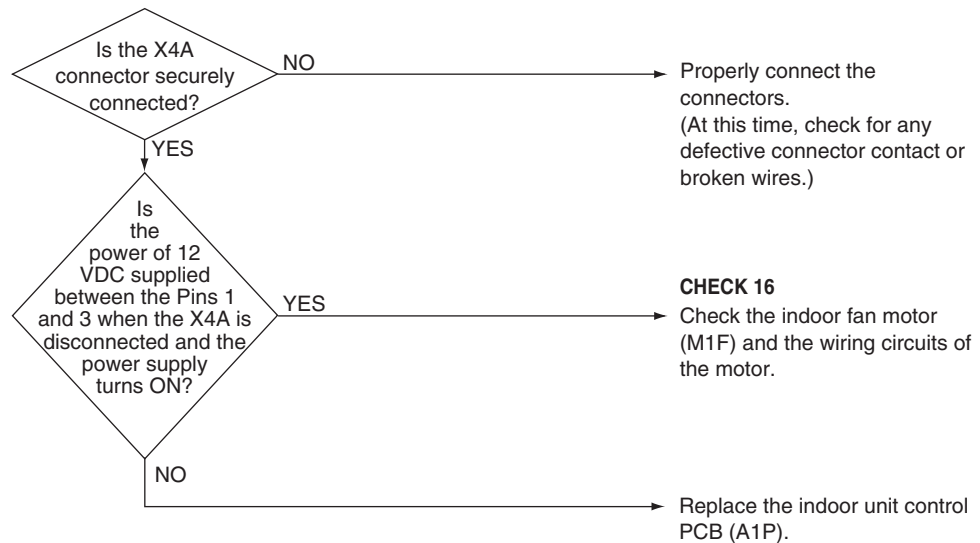

**Reference**

**CHECK 16** Refer to page 466.

### 3.8.3 Indoor Fan Motor Abnormality (FXSQ54TA, FXSQ54TB, FXMQ15-54PB, FXMQ30-54TB, FXMQ-TA Models)

<b>Applicable Models</b>	FXSQ54TA, FXSQ54TB, FXMQ15-54PB, FXMQ30-54TB, FXMQ-TA
<b>Error Code</b>	<b>A6</b>
<b>Method of Error Detection</b>	<ul style="list-style-type: none"> <li>■ Error from the current flow on the fan PCB</li> <li>■ Error from the rotation speed of the fan motor in operation</li> <li>■ Error from the position signal of the fan motor</li> <li>■ Error from the current flow on the fan PCB when the fan motor starting operation</li> </ul>
<b>Error Decision Conditions</b>	<ul style="list-style-type: none"> <li>■ An overcurrent flows.</li> <li>■ The rotation speed is less than a certain level for 6 seconds.</li> <li>■ A position error in the fan rotor continues for 5 seconds or more.</li> </ul>
<b>Supposed Causes</b>	<ul style="list-style-type: none"> <li>■ Clogging of a foreign matter</li> <li>■ Disconnection of the fan motor connectors (X1A and X2A)</li> <li>■ Disconnection of the connectors between the indoor unit control PCB (A1P) and fan PCB (A2P)</li> <li>■ Defective fan PCB (A2P)</li> <li>■ Defective fan motor</li> </ul>

## Troubleshooting

**Caution**

Be sure to turn off the power switch before connecting or disconnecting connectors, or parts may be damaged.

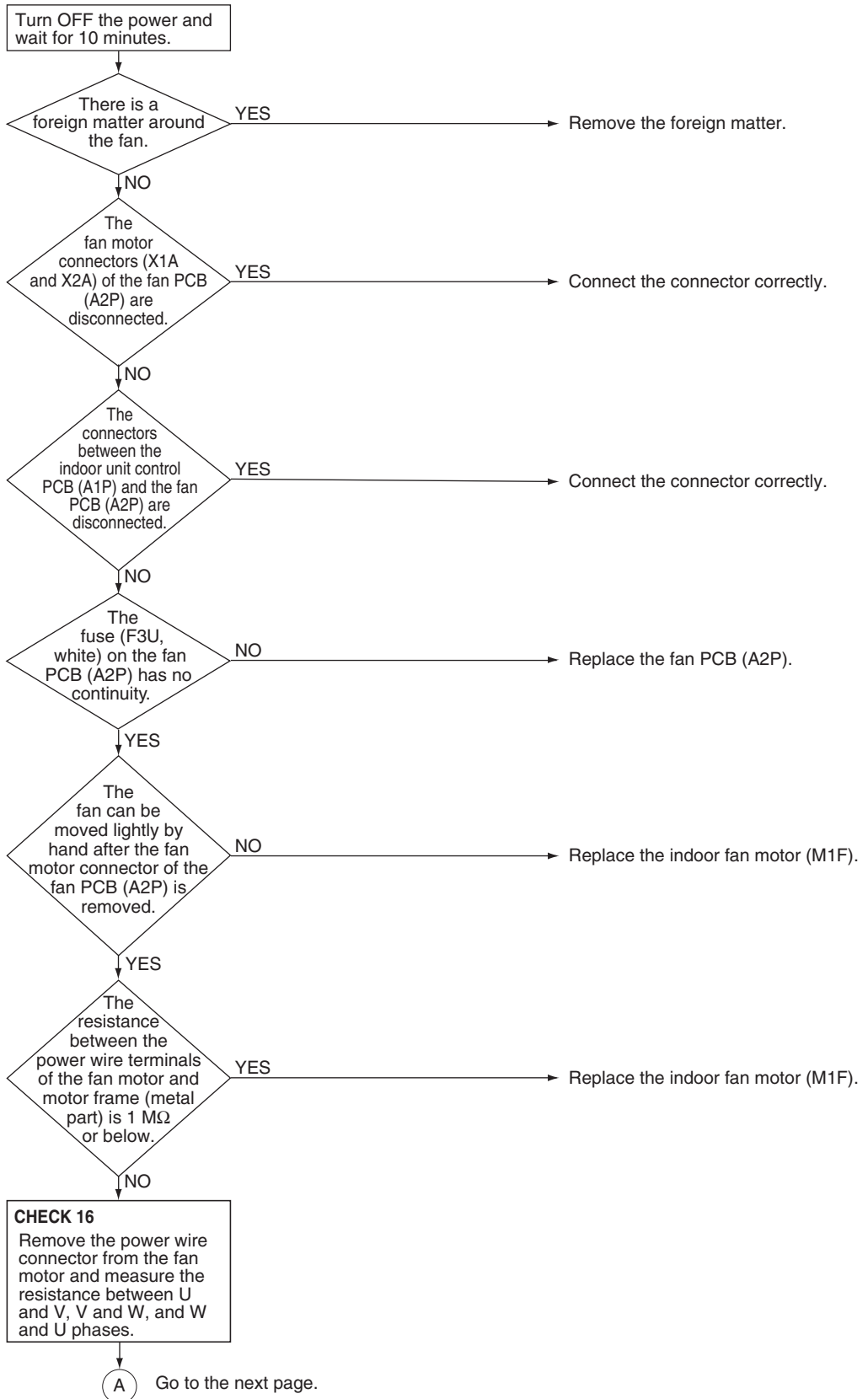

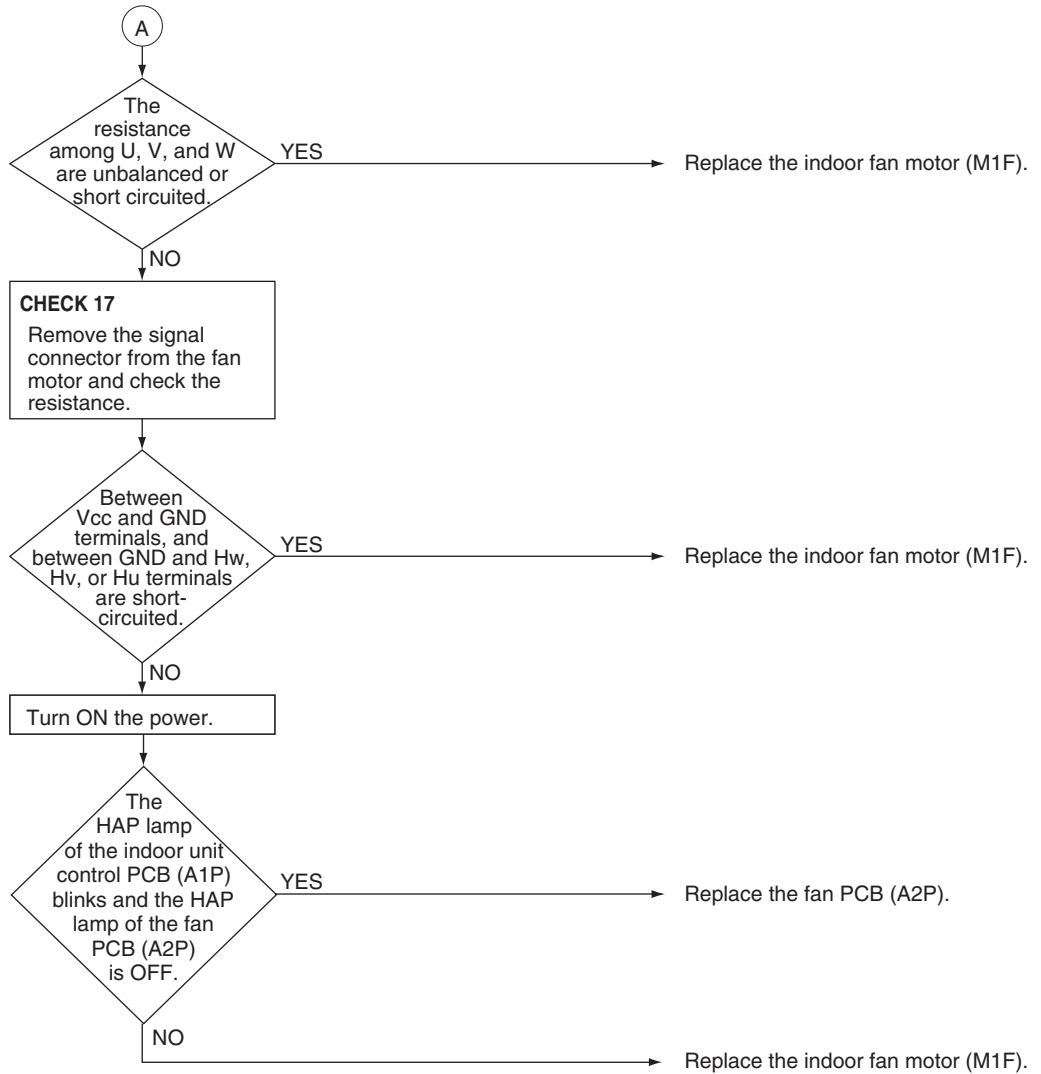

 Reference **CHECK 16** Refer to page 466.

 Reference **CHECK 17** Refer to page 468.



## 3.9 Overload/Overcurrent/Lock of Indoor Fan Motor

**Applicable Models** FXMQ-M

**Error Code** **A6**

**Outline** This error is detected by detecting that the individual power supply for the fan turns OFF.

**Error Decision Conditions** When it is not detected that the individual power supply for the indoor fan turns ON while in operation.

**Supposed Causes**

- Defective power supply for the indoor fan motor
- Clogged drain piping
- Activation of the indoor unit safety device
- Defective contact in the fan wiring circuit

### Troubleshooting

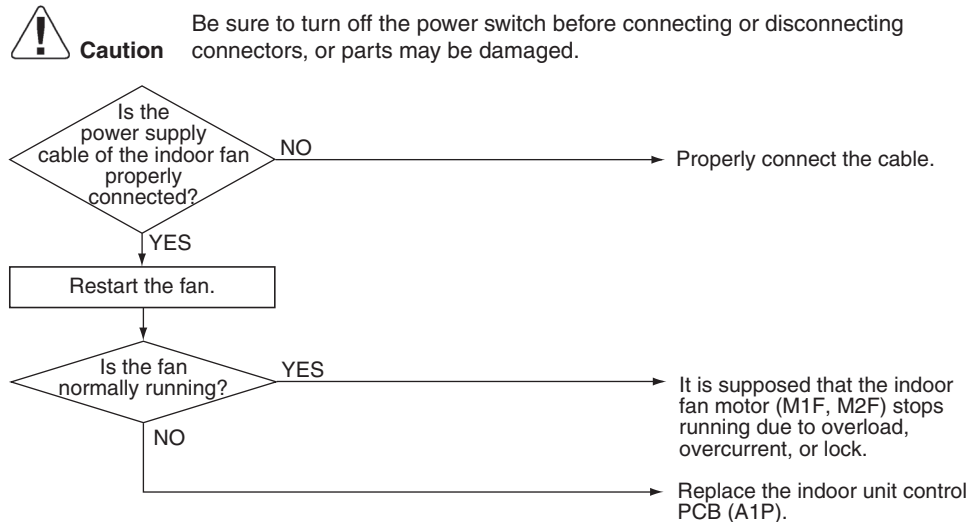

## 3.10 Blower Motor Not Running

<b>Applicable Models</b>	FXTQ-TA, FXTQ-TB
<b>Error Code</b>	<b>A6</b>
<b>Outline</b>	Error is issued if the indoor unit determines that the indoor fan motor cannot rotate.
<b>Error Decision Conditions</b>	<ul style="list-style-type: none"> <li>■ <b>Determining successive abnormalities</b>                      Checks the rotation speed at 5-second intervals using the feedback of the fan motor.                      If that figure falls below 50 rpm for the specified number of consecutive times successively, it is deemed abnormal operation.                      If, during operation, the rotation command is stopped, the 5-second interval check is halted and the counted number will be cleared.</li>   <li>■ <b>Determining long-term abnormalities</b>                      Checks the rotation speed at 5-second intervals using the feedback of the fan motor.                      Performs rotation sampling 720 times (takes approximately one hour), and if the rotation speed falls below 50 rpm over 100 times, it is deemed abnormal operation.                      When the sampling reaches 720 times, the counted number will be cleared and the 720 times sampling restarts.                      If, during this, the rotation command is stopped, the 5-second interval check is halted, but the counted number will be kept.                      When the rotation command is restarted, the checks will resume.</li> </ul>
<b>Error Reset Conditions</b>	Reset by remote controller
<b>Supposed Causes</b>	<ul style="list-style-type: none"> <li>■ Fan or motor obstruction</li> <li>■ Power interruption (low voltage)</li> <li>■ Incorrect or loose wiring</li> </ul>
<b>Corrective Actions</b>	<ul style="list-style-type: none"> <li>■ Check for obstruction on the fan or motor.</li> <li>■ Verify the input voltage at the motor.</li> <li>■ Check wiring or tighten wiring connections if needed.</li> <li>■ Replace the indoor unit control PCB or motor.</li> </ul>



Reference

**CHECK 19** Refer to page 474.

## 3.11 Indoor Fan Motor Status Abnormality

**Applicable Models** FXTQ-TA, FXTQ-TB

**Error Code** **A6-20**

**Outline** The indoor unit periodically receives control status information from the fan motor. Error is issued when the information shows abnormality.

**Error Decision Conditions** If the information shows Power Limit or Temp Limit status, it will be deemed a MOTOR LIMIT abnormal operation. (The system can keep operating.)  
If the information shows Motor Lost Control or Current Trip status, it will be deemed a MOTOR TRIP abnormal operation. (The system stops operating.)

**Error Reset Conditions** If the indoor unit stops receiving abnormal information, the error will be cleared.

**Supposed Causes**

- Fan or motor obstruction
- Blocked filters
- Power interruption (low voltage)
- Incorrect wiring
- Blockage in the airflow (ductwork) or ductwork undersized
- High loading conditions

**Corrective Actions**

- Check for obstruction on the fan, motor, or ductwork.
- Clean filters.
- Check filters, grille, duct system, heat exchanger air inlet/outlet for blockages.
- Verify the input voltage at the motor.
- Check wiring.
- Replace motor.



**Reference**

**CHECK 19** Refer to page 474.

## 3.12 Low Indoor Airflow

**Applicable Models**

FXTQ-TA, FXTQ-TB

**Error Code**

**A6-21**

**Outline**

Error is issued if the indoor unit determines that the indoor fan motor rotation is insufficient, regardless of the rotation command from indoor unit.

**Error Decision Conditions**

- Determining successive abnormalities  
Checks the rotation speed at 5-second intervals using the feedback of the fan motor. If that figure exceeds 50 rpm and falls below 150 rpm 10 times successively, it is deemed abnormal operation.  
If, during operation, the rotation command is stopped, the 5-second interval check is halted and the counted number will be cleared.
- Determining long-term abnormalities  
Checks the rotation speed at 5-second intervals using the feedback of the fan motor. Performs rotation sampling 720 times (takes approximately one hour), and if the rotation speed exceeds 50 rpm and falls below 150 rpm over 360 times, it is deemed abnormal operation. When the counter reaches 720 times, the counted number will be cleared and the 720 times sampling restarts.  
If, during this, the rotation command is stopped, the 5-second interval check is halted, but the counted number will be kept.  
When the rotation command is restarted, the checks will resume.

**Error Reset Conditions**

- Determining successive abnormalities  
Checks the rotation speed at 5-second intervals using the feedback of the fan motor. If that figure exceeds 150 rpm even once, the error will be cleared.
- Determining long-term abnormalities  
Checks the rotation speed at 5-second intervals using the feedback of the fan motor. If that figure exceeds 150 rpm 36 times successively, the error will be cleared. At that point, the counted number and sampling number will be cleared, and the 720 times sampling starts again from the beginning.

**Supposed Causes**

- Fan or motor obstruction
- Blocked filters
- Restrictive ductwork or ductwork undersized
- Wiring disconnected
- Wrong outdoor and indoor combination
- Indoor fan motor failure

**Corrective Actions**

- Check for obstruction on the fan or motor.
- Check ductwork and filter for blockage.
- Clean filters.
- Remove obstruction. Verify all registers are fully open.
- Check the connections and the rotation of the motor.
- Verify the input voltage at the motor.
- Verify ductwork is appropriately sized for system. Resize or replace ductwork if needed.
- Replace motor.



Reference

**CHECK 19** Refer to page 474.

## 3.13 Swing Flap Motor Abnormality

**Applicable Models** FXHQ-M, FXAQ-P

**Error Code** **A7**

**Method of Error Detection** Utilizes ON/OFF of the limit switch when the motor turns.

**Error Decision Conditions** When ON/OFF of the micro-switch for positioning cannot be reversed even though the swing flap motor is energized for a specified amount of time (about 30 seconds).  
\* Error code is displayed but the system operates continuously.

**Supposed Causes**

- Defective swing motor
- Defective connection cable (power supply and limit switch)
- Defective airflow direction adjusting flap-cam
- Defective indoor unit control PCB

### Troubleshooting



**Caution**

Be sure to turn off the power switch before connecting or disconnecting connectors, or parts may be damaged.

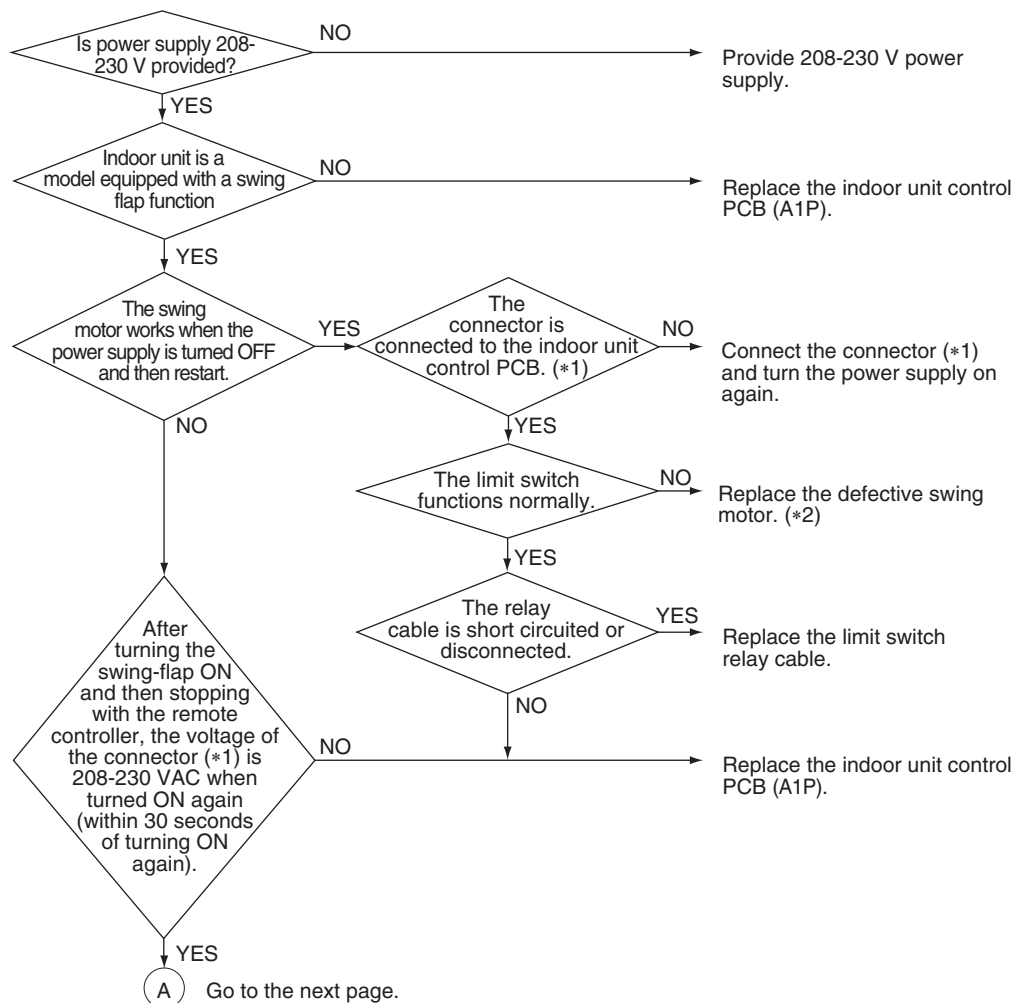

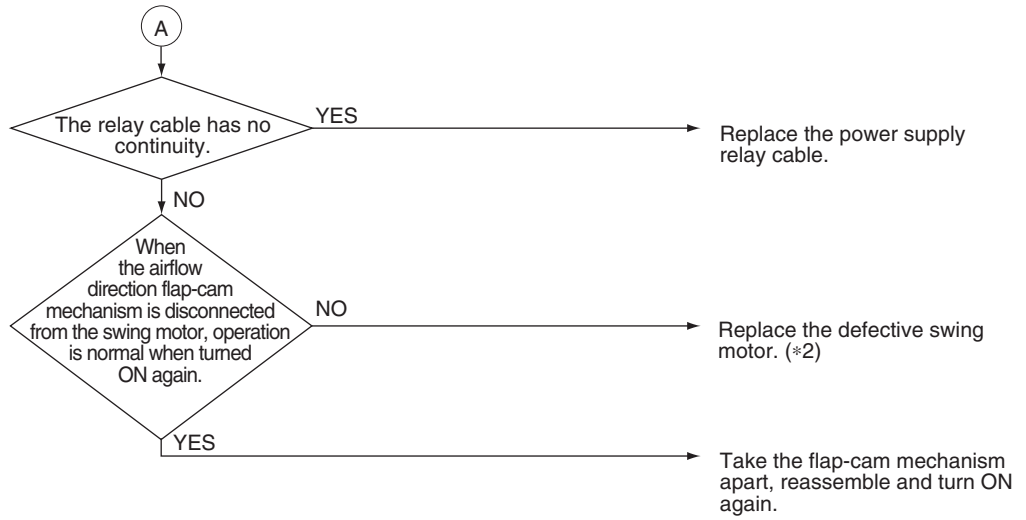

Model	*1: Swing motor connector	*2: Swing motor
FXHQ-M	X6A	M1S
FXAQ-P	X36A	M1S

## 3.14 Power Supply Voltage Abnormality

**Applicable Models** FXSQ-TA, FXSQ-TB, FXMQ-PB, FXMQ-TB

**Error Code** **A8**

**Method of Error Detection** Error is detected by checking the input voltage of the fan motor.

**Error Decision Conditions** When the input voltage of fan motor is 150 V or less, or 386 V or more.

**Supposed Causes**

- Defective power supply voltage
- Defective connection on signal line
- Defective wiring
- Instantaneous power failure, others

### Troubleshooting



**Caution**

Be sure to turn off the power switch before connecting or disconnecting connectors, or parts may be damaged.

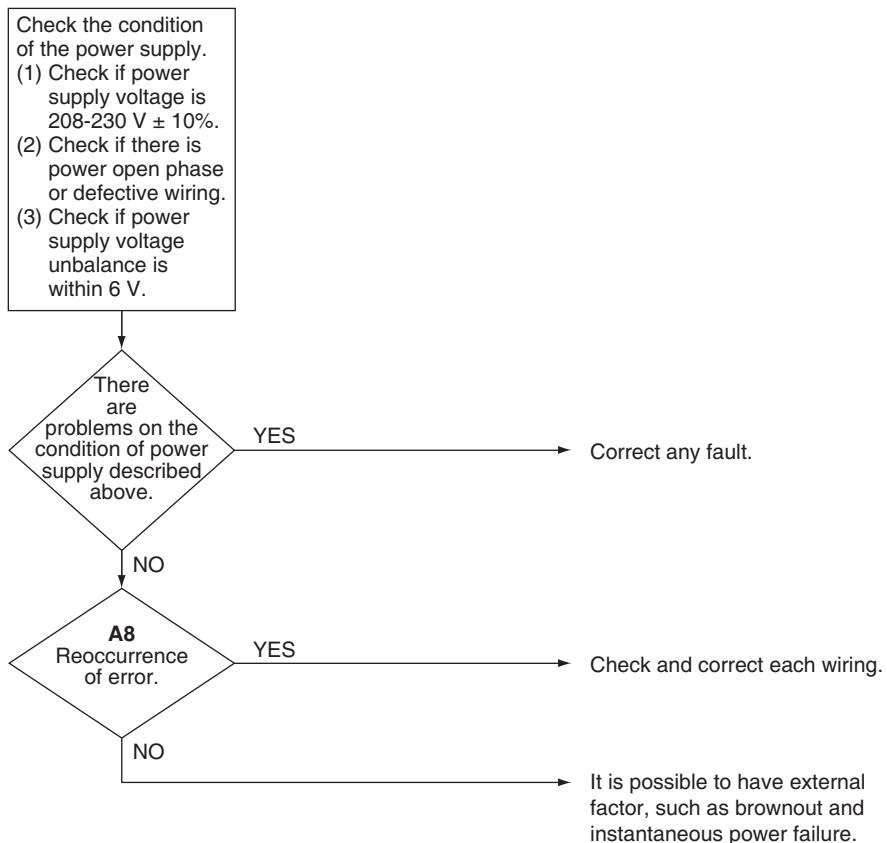

### 3.15 Blower Motor Stops for Over/Under Voltage

<b>Applicable Models</b>	FXTQ-TA, FXTQ-TB
<b>Error Code</b>	<b>A8</b>
<b>Outline</b>	The indoor unit periodically receives control status information from the fan motor. Error is issued when the information shows abnormality.
<b>Error Decision Conditions</b>	If the information shows Over/Under Voltage status, it will be deemed a MOTOR VOLTS abnormal operation.
<b>Error Reset Conditions</b>	Reset by remote controller
<b>Supposed Causes</b>	<ul style="list-style-type: none"> <li>■ High AC line voltage to indoor blower motor</li> <li>■ Low AC line voltage to indoor blower motor</li> <li>■ Incorrect wiring</li> </ul>
<b>Corrective Actions</b>	<ul style="list-style-type: none"> <li>■ Verify line voltage to indoor blower motor is within the range specified on the ID blower rating plate.</li> <li>■ Check power to indoor blower motor.</li> <li>■ Check wiring.</li> <li>■ Replace motor.</li> </ul>



### 3.16 Electronic Expansion Valve Coil Abnormality, Dust Clogging

<b>Applicable Models</b>	All indoor unit models
<b>Error Code</b>	<b>A9</b>
<b>Method of Error Detection</b>	Check coil condition of electronic expansion valve by using microcomputer. Check dust clogging condition of electronic expansion valve main body by using microcomputer.
<b>Error Decision Conditions</b>	Pin input for electronic expansion valve coil is abnormal when initializing microcomputer. Either of the following conditions is seen/caused/occurs while the unit stops operation. <ul style="list-style-type: none"> <li>● R1T – R2T &gt; 8°C (14.4°F)</li> <li>● R2T shows fixed degrees or below.</li> </ul> R1T: temperature of suction air R2T: temperature of liquid pipe of heat exchanger
<b>Supposed Causes</b>	<ul style="list-style-type: none"> <li>■ Defective electronic expansion valve coil</li> <li>■ Defective indoor unit control PCB</li> <li>■ Defective relay cables</li> </ul>

**Troubleshooting**

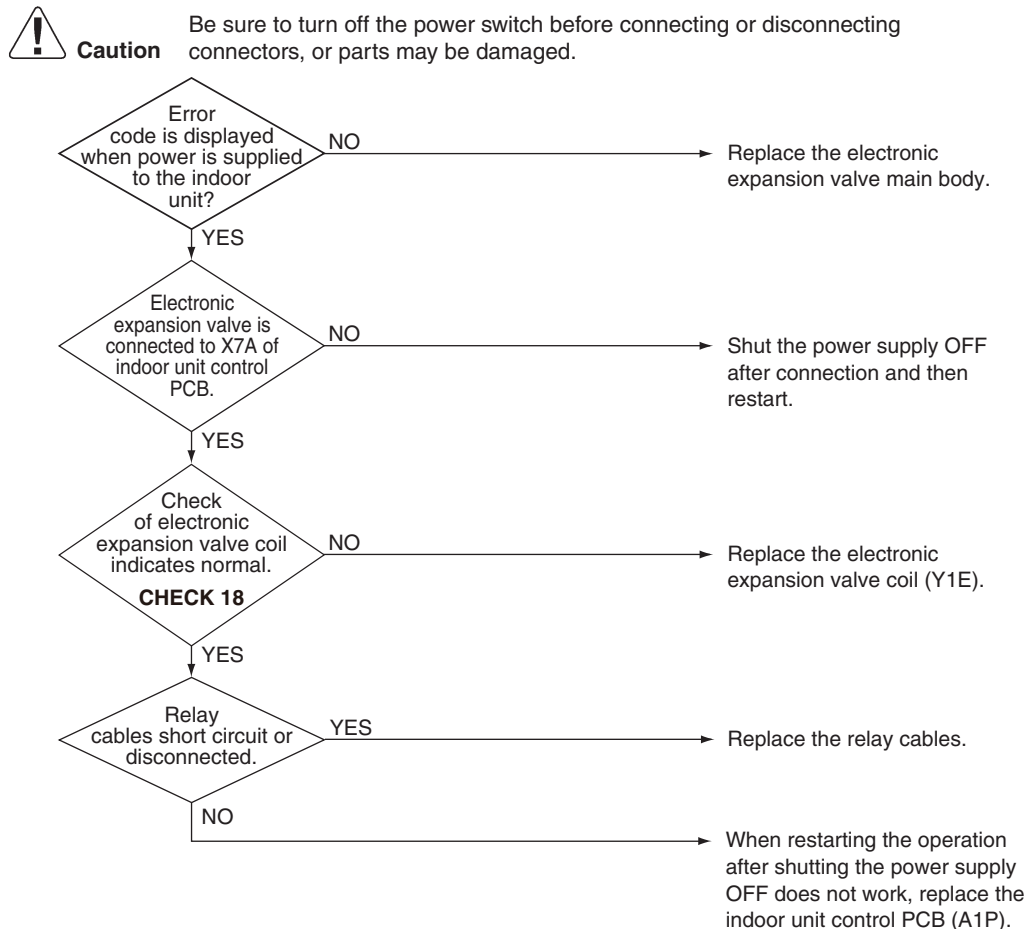

 **Reference** CHECK 18 Refer to page 470.

### 3.17 Gas Furnace Abnormality

<b>Applicable Models</b>	CXTQ-TA
<b>Error Code</b>	<b>AA-03</b>
<b>Method of Error Detection</b>	Detects the error signal from the gas furnace when any error occurs on the gas furnace. The indoor unit displays <b>AA-03</b> for any sort of gas furnace abnormality.
<b>Error Decision Conditions</b>	The error status differs depending on each error code of the gas furnace. Refer to the gas furnace manual for details.
<b>Supposed Causes</b>	The cause of the error differs depending on each error code of the gas furnace. Refer to the gas furnace manual for details.

**Troubleshooting**



**Caution**

Be sure to turn off the power switch before connecting or disconnecting connectors, or parts may be damaged.

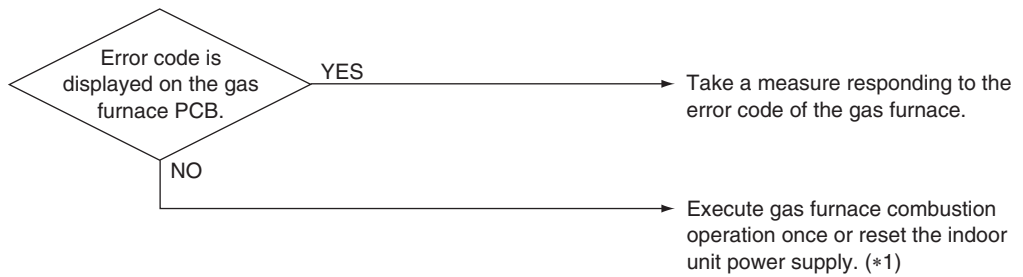

**Note(s)**

\*1. In some cases of gas furnace abnormality regarding gas combustion, once an error occurs, display indication of **AA-03** is retained even after the gas furnace recovered from the error to notify the occurrence of the error. The error indication disappears if you execute gas furnace combustion once or reset the indoor unit power supply.

## 3.18 Drain Level above Limit

<b>Applicable Models</b>	FXFQ-AA, FXFQ-T, FXZQ-TA, FXZQ-TB, FXUQ-P, FXUQ-PA, FXEQ-P, FXDQ-M, FXSQ-TA, FXSQ-TB, FXMQ-PB, FXMQ-TB, FXMQ-TA (Option)
<b>Error Code</b>	<b>AF</b>
<b>Method of Error Detection</b>	Water leakage is detected based on float switch ON/OFF operation while the compressor is not in operation.
<b>Error Decision Conditions</b>	When the float switch changes from ON to OFF while the compressor is not in operation. * Error code is displayed but the system operates continuously.
<b>Supposed Causes</b>	<ul style="list-style-type: none"> <li>■ Humidifier unit (optional accessory) leaking</li> <li>■ Defective drain pipe (upward slope, etc.)</li> <li>■ Defective indoor unit control PCB</li> </ul>

### Troubleshooting

**Caution**

Be sure to turn off the power switch before connecting or disconnecting connectors, or parts may be damaged.

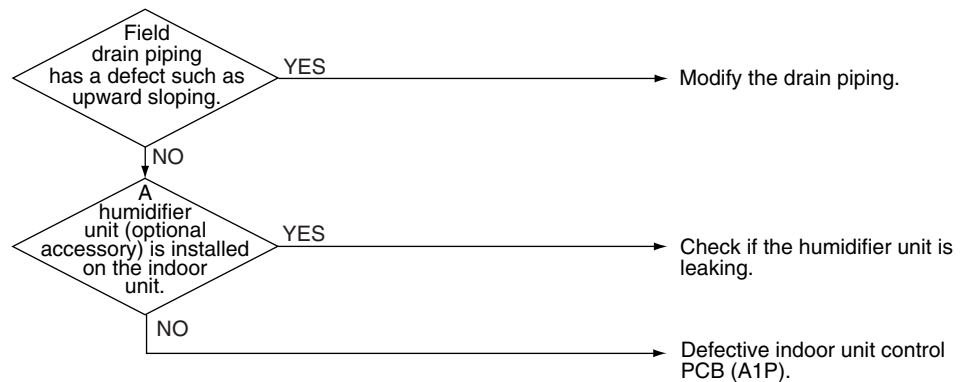

## 3.19 Self-Cleaning Decoration Panel Abnormality

<b>Applicable Models</b>	FXFQ-AA (when self-cleaning decoration panel BYCQ54EEGFU is installed) FXFQ-T (when self-cleaning decoration panel BYCQ125BGW1 is installed)
<b>Error Code</b>	<b>AH</b>
<b>Method of Error Detection</b>	Error is detected by abnormal signal from the self-cleaning decoration panel.
<b>Error Decision Conditions</b>	<p>Any of the following conditions is met while the unit is in operation.</p> <ul style="list-style-type: none"> <li>■ There is a transmission error between self-cleaning decoration panel and indoor unit.</li> <li>■ Dust detection sensor (light receiving side) is short-circuited.</li> <li>■ The total of fan operation time exceeds a specified value after dust collection sign display.</li> <li>■ Limit switch does not detect when air filter rotates or air filter does not rotate.</li> <li>■ Limit switch does not detect when damper opens (or closes) or damper does not work.</li> <li>■ Filter auto clean operation does not complete even after a specified time has elapsed.</li> <li>■ Filter auto clean operation does not start even after a specified time has elapsed.</li> </ul>
<b>Supposed Causes</b>	<ul style="list-style-type: none"> <li>■ Transmission error (between self-cleaning decoration panel and indoor unit)</li> <li>■ Dust detection sensor error</li> <li>■ Dust collection sign</li> <li>■ Air filter rotation error</li> <li>■ Damper rotation error</li> <li>■ Filter auto clean operation error</li> <li>■ Filter auto clean operation start disabled error</li> </ul>

## Troubleshooting



### Caution

Be sure to turn off the power switch before connecting or disconnecting connectors, or parts may be damaged.

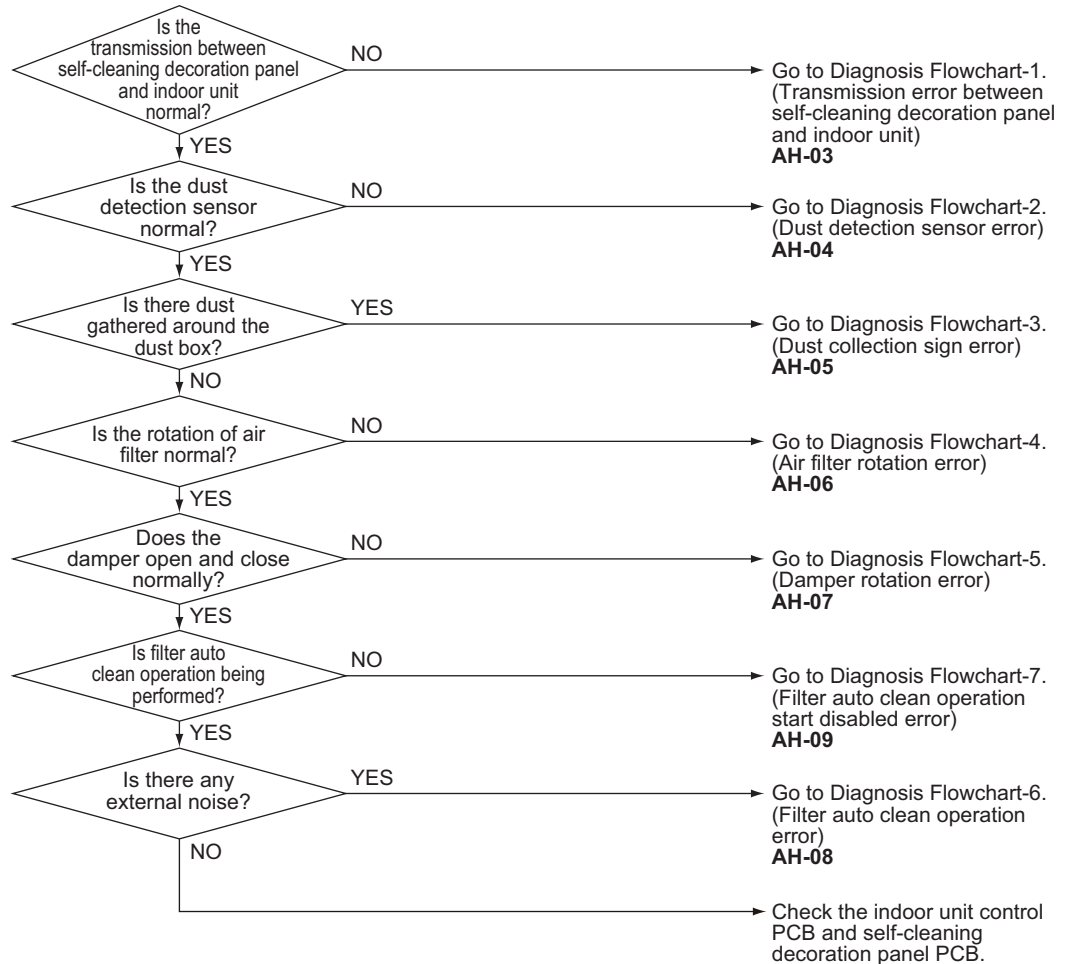

### Reference

Refer to the diagnosis flowchart below.

Error code	Diagnosis Flowchart
<b>AH-03</b>	Diagnosis Flowchart-1 on page 339
<b>AH-04</b>	Diagnosis Flowchart-2 on page 340
<b>AH-05</b>	Diagnosis Flowchart-3 on page 341
<b>AH-06</b>	Diagnosis Flowchart-4 on page 342
<b>AH-07</b>	Diagnosis Flowchart-5 on page 344
<b>AH-08</b>	Diagnosis Flowchart-6 on page 346
<b>AH-09</b>	Diagnosis Flowchart-7 on page 347



**Caution**

Be sure to turn off the power switch before connecting or disconnecting connectors, or parts may be damaged.

Diagnosis Flowchart-1

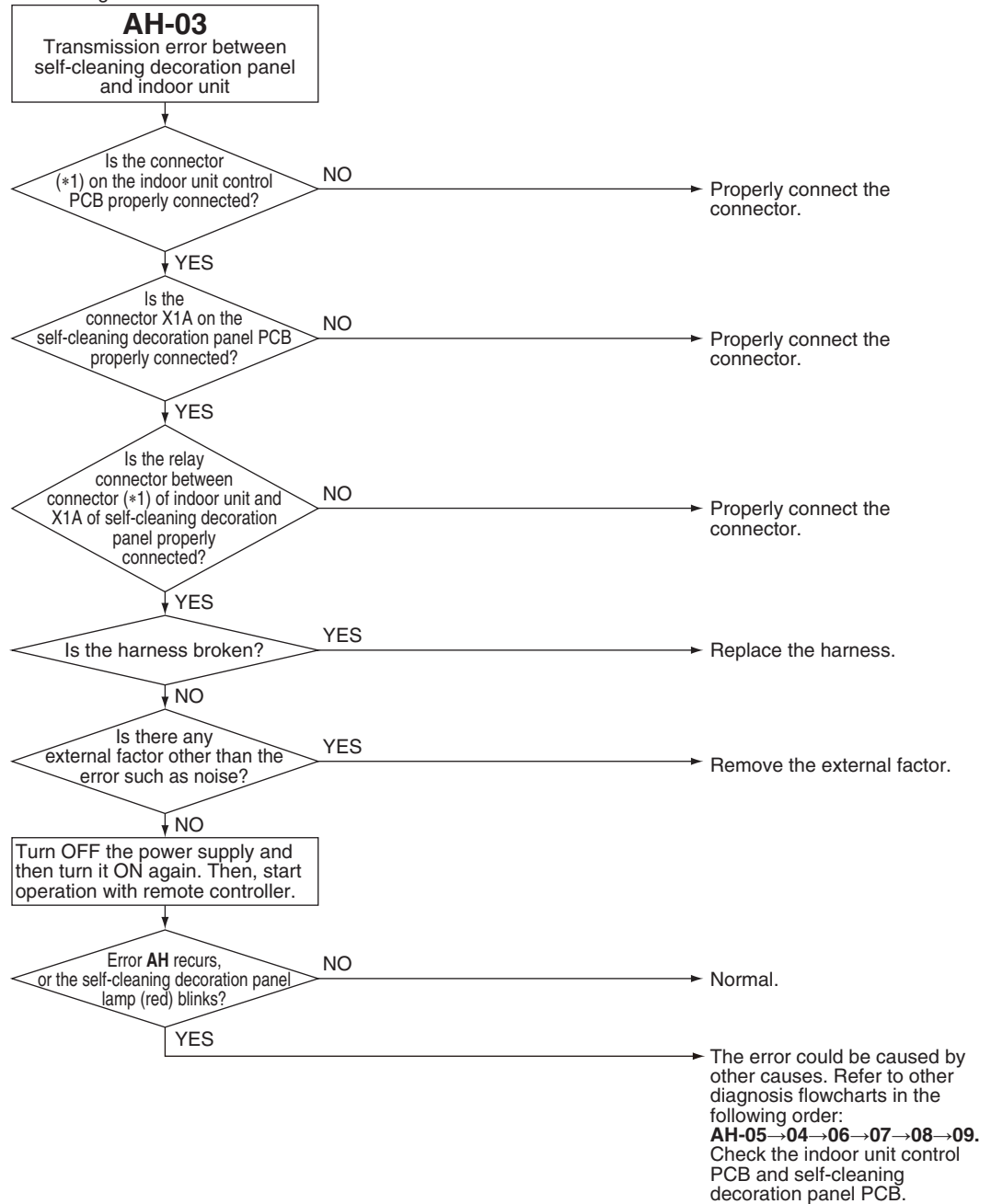

**Note(s)**

\*1. Connector

Model	Connector
FXFQ-AA	X70A
FXFQ-T	X8A



**Caution**

Be sure to turn off the power switch before connecting or disconnecting connectors, or parts may be damaged.

Diagnosis Flowchart-2

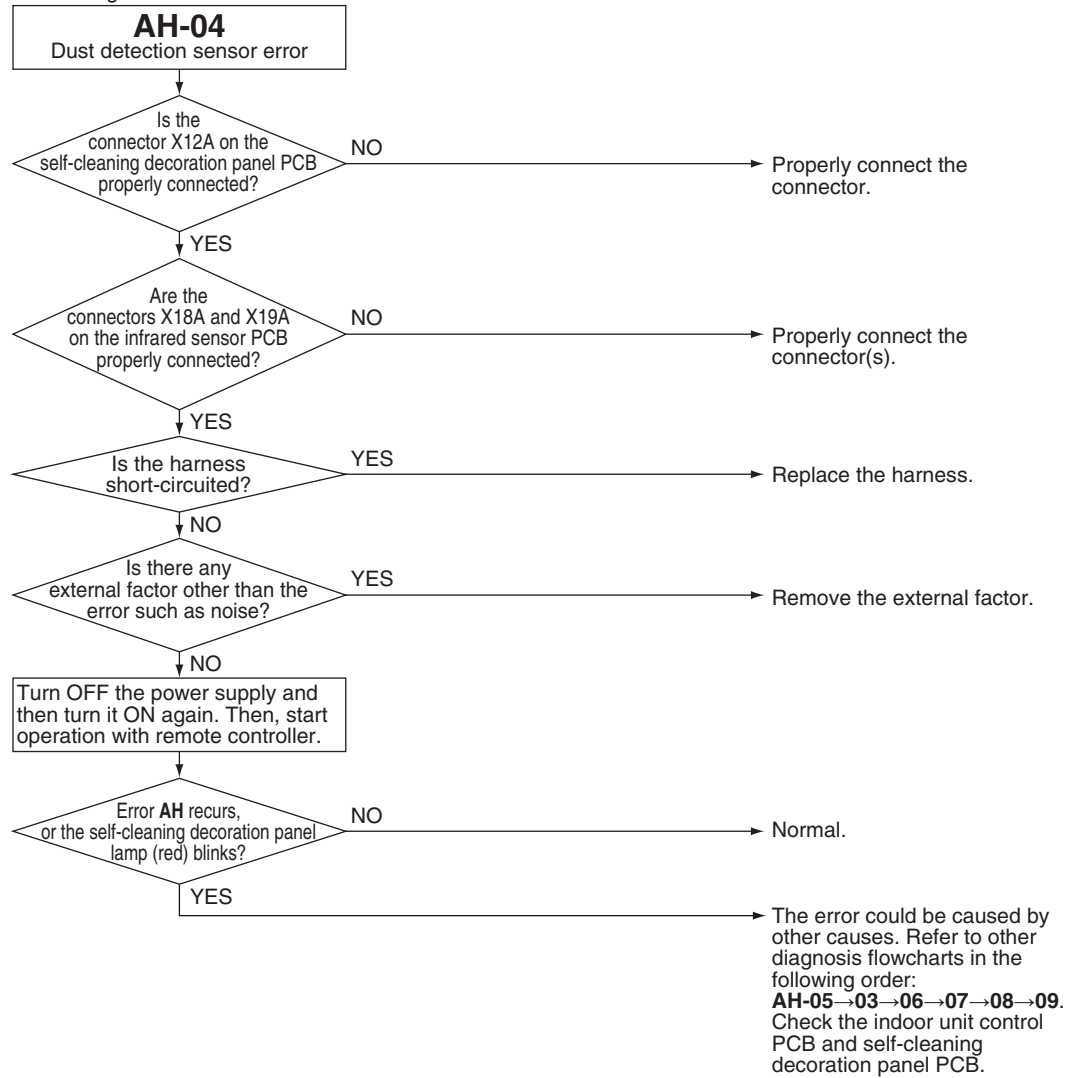



**Caution**

Be sure to turn off the power switch before connecting or disconnecting connectors, or parts may be damaged.

Diagnosis Flowchart-3

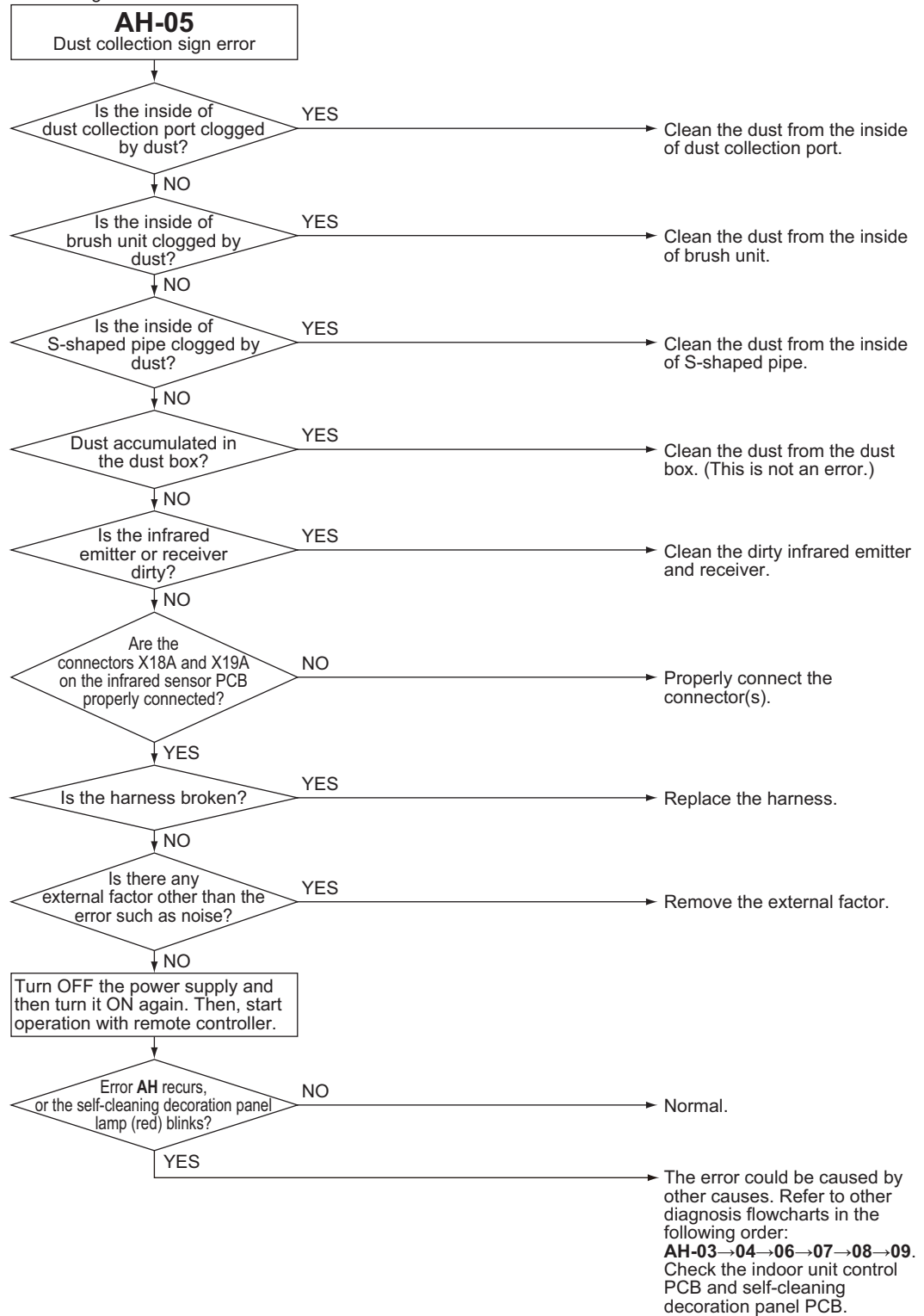



**Caution**

Be sure to turn off the power switch before connecting or disconnecting connectors, or parts may be damaged.

## Diagnosis Flowchart-4

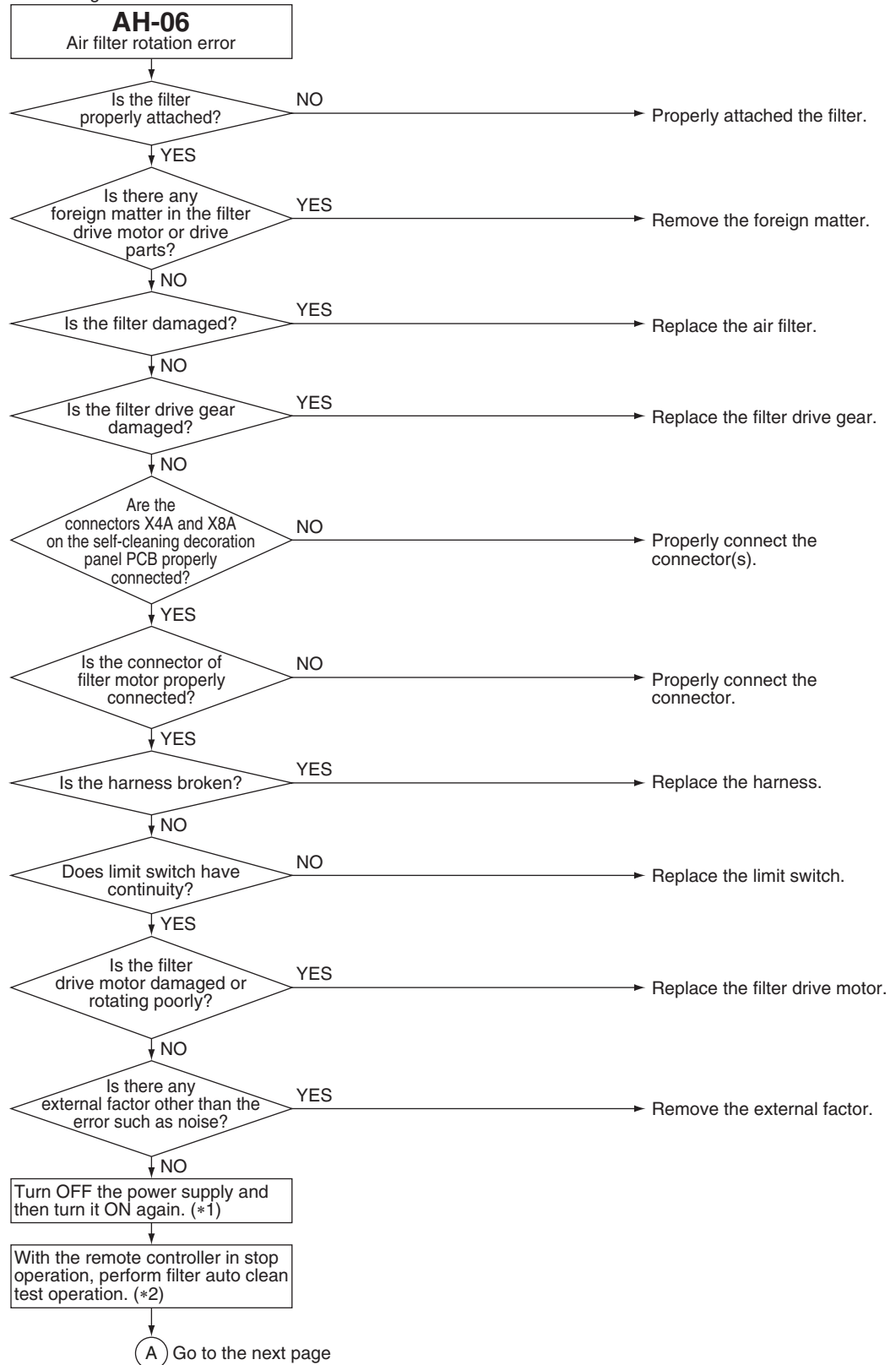

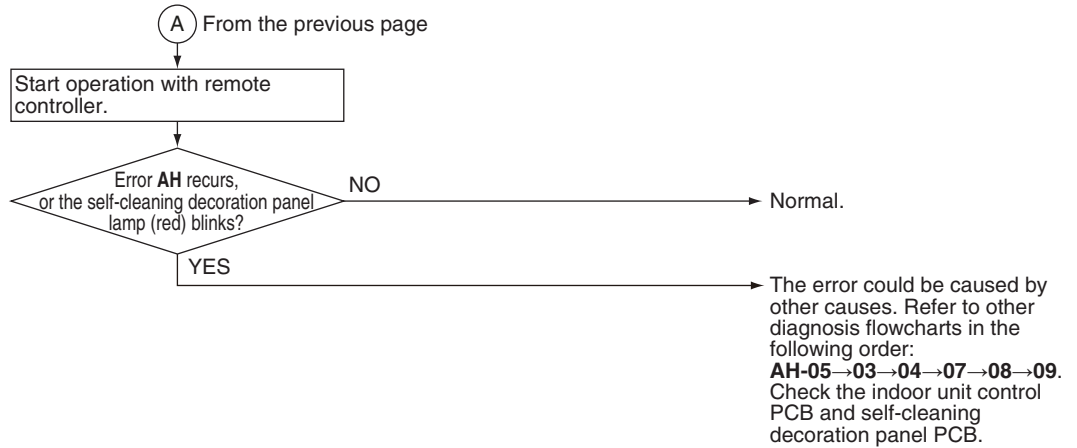

**i** Note(s)

\*1. Temporary error code reset operation can be performed by pressing the push switch button (BS2) on the self-cleaning decoration panel PCB

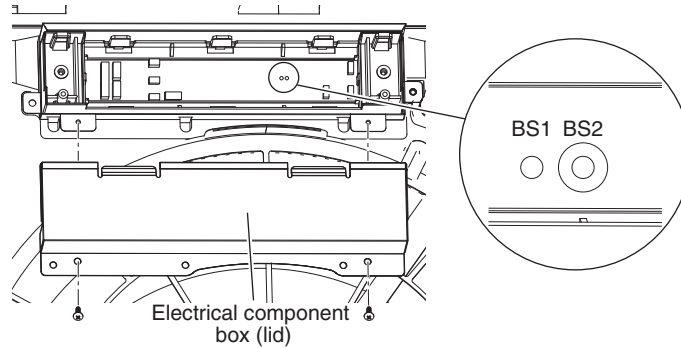

\*2. For details on performing filter auto clean test operation, refer to the operation manual of the self-cleaning decoration panel.



**Caution**

Be sure to turn off the power switch before connecting or disconnecting connectors, or parts may be damaged.

Diagnosis Flowchart-5

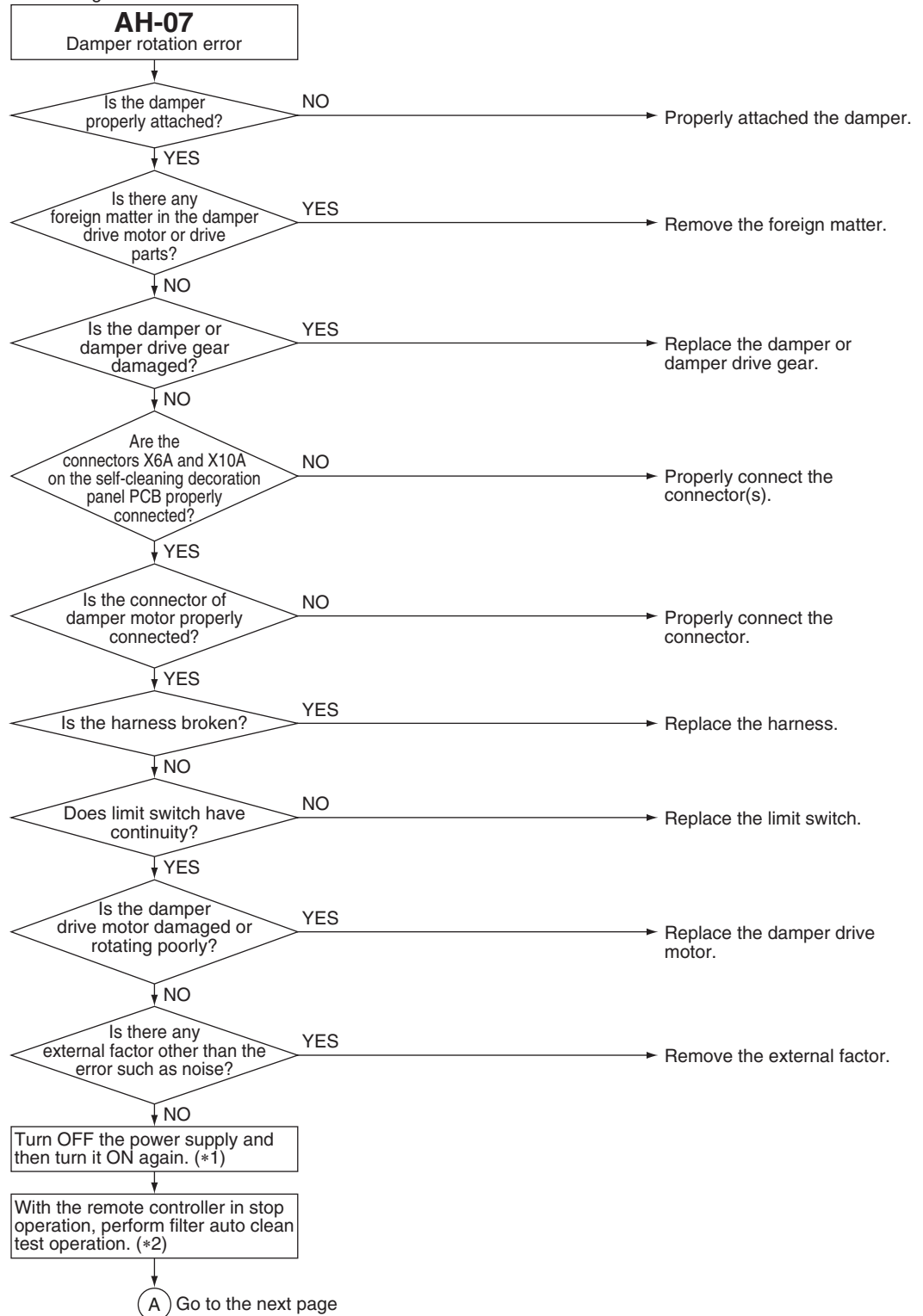

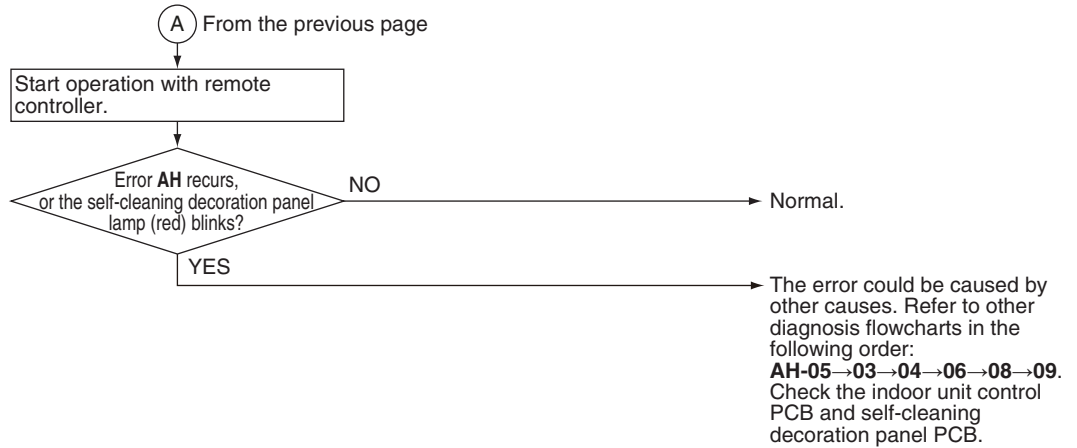

**i** Note(s)

\*1. Temporary error code reset operation can be performed by pressing the push switch button (BS2) on the self-cleaning decoration panel PCB

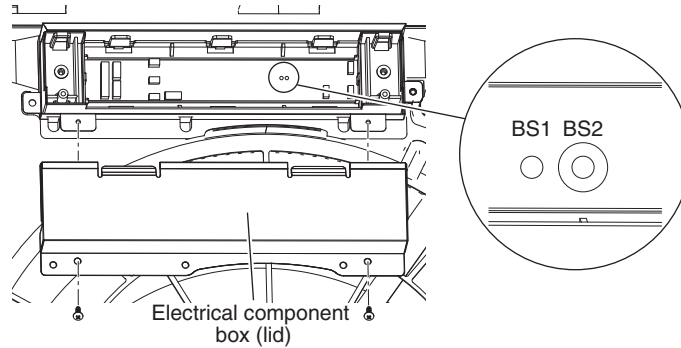

\*2. For details on performing filter auto clean test operation, refer to the operation manual of the self-cleaning decoration panel.

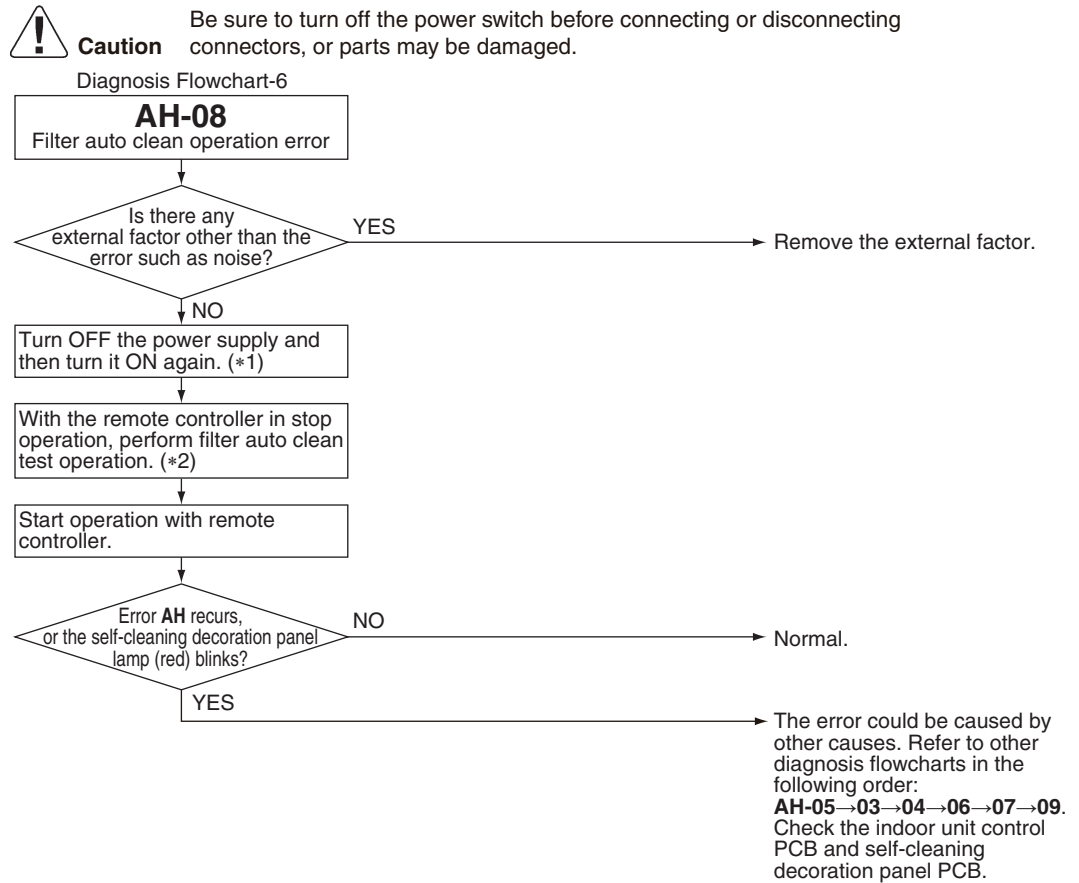
**Note(s)**

\*1. Temporary error code reset operation can be performed by pressing the push switch button (**BS2**) on the self-cleaning decoration panel PCB

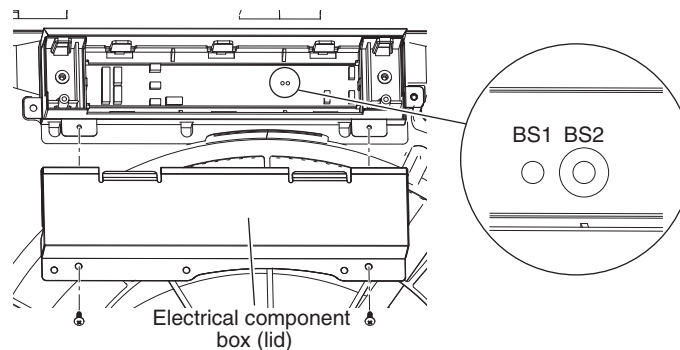

\*2. For details on performing filter auto clean test operation, refer to the operation manual of the self-cleaning decoration panel.



**Caution**

Be sure to turn off the power switch before connecting or disconnecting connectors, or parts may be damaged.

Diagnosis Flowchart-7

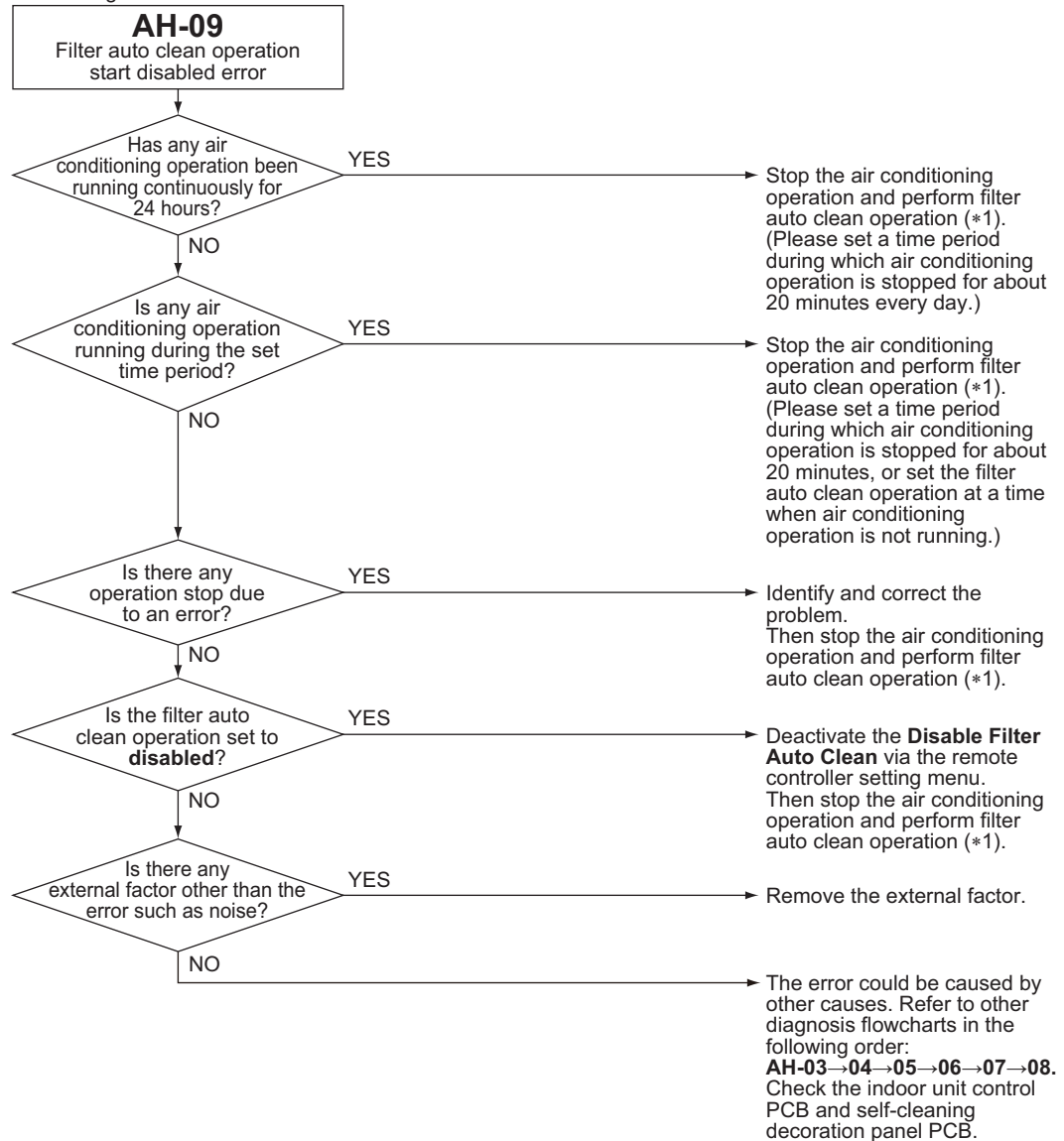

**Note(s)**

\*1. If the filter auto clean operation mode is set to a designated time period, perform a filter auto clean operation as described below to clear the **AH** error code. (If scheduled operation time is not set, the filter auto clean operation will be performed automatically after air conditioning operation is stopped, so the following operation is unnecessary.)

1. On the remote controller, select **Filter Auto Clean** menu. The screen will change into a cleaning time period setting screen. Confirm the set time period. (Example: 0:00 to 3:00)
2. Select **Clock & Calendar** on the remote controller and set the current time to the time one minute before the beginning of the time set in step 1. (Example: If the set time is from 0:00 to 3:00, set the current time to 23:59, one minute before 0:00)
3. After about 1 minute, filter auto clean operation will start. (**AH** error cleared)
4. After confirming that the filter auto clean operation is finished, return the time changed in step 2 to the regular time.

## 3.20 Defective Capacity Setting

<b>Applicable Models</b>	All indoor unit models
<b>Error Code</b>	<b>AJ</b>
<b>Method of Error Detection</b>	Capacity is determined according to resistance of the capacity setting adaptor and the memory inside the IC memory on the indoor unit control PCB, and whether the value is normal or abnormal is determined.
<b>Error Decision Conditions</b>	When the capacity code is not saved to the PCB, and the capacity setting adaptor is not connected. When a capacity that does not exist for that unit is set.
<b>Supposed Causes</b>	<ul style="list-style-type: none"> <li>■ The capacity setting adaptor was not installed.</li> <li>■ Defective indoor unit control PCB</li> </ul>
<b>Troubleshooting</b>	

**Caution**

Be sure to turn off the power switch before connecting or disconnecting connectors, or parts may be damaged.

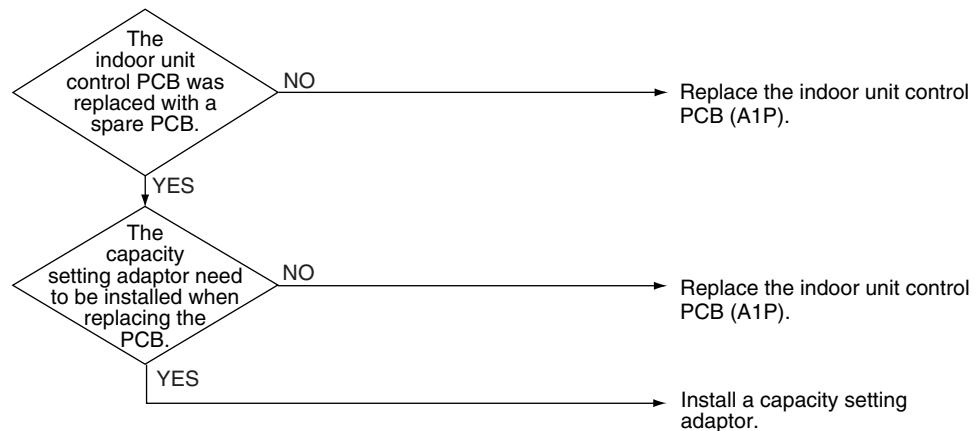

## 3.21 Transmission Abnormality between Indoor Unit Control PCB and Fan PCB

---

<b>Applicable Models</b>	FXSQ-TA, FXSQ-TB, FXMQ-PB, FXMQ-TB, FXMQ-TA
<b>Error Code</b>	<b>C1</b>
<b>Method of Error Detection</b>	Transmission conditions between the indoor unit control PCB (A1P) and fan PCB (A2P) are checked via microcomputer.
<b>Error Decision Conditions</b>	When normal transmission is not carried out for a certain duration.
<b>Supposed Causes</b>	<ul style="list-style-type: none"><li>■ Connection defective the connector between indoor unit control PCB (A1P) and fan PCB (A2P)</li><li>■ Defective indoor unit control PCB (A1P)</li><li>■ Defective fan PCB (A2P)</li><li>■ External factor, such as instantaneous power failure</li></ul>

---



## Troubleshooting

**Caution**

Be sure to turn off the power switch before connecting or disconnecting connectors, or parts may be damaged.

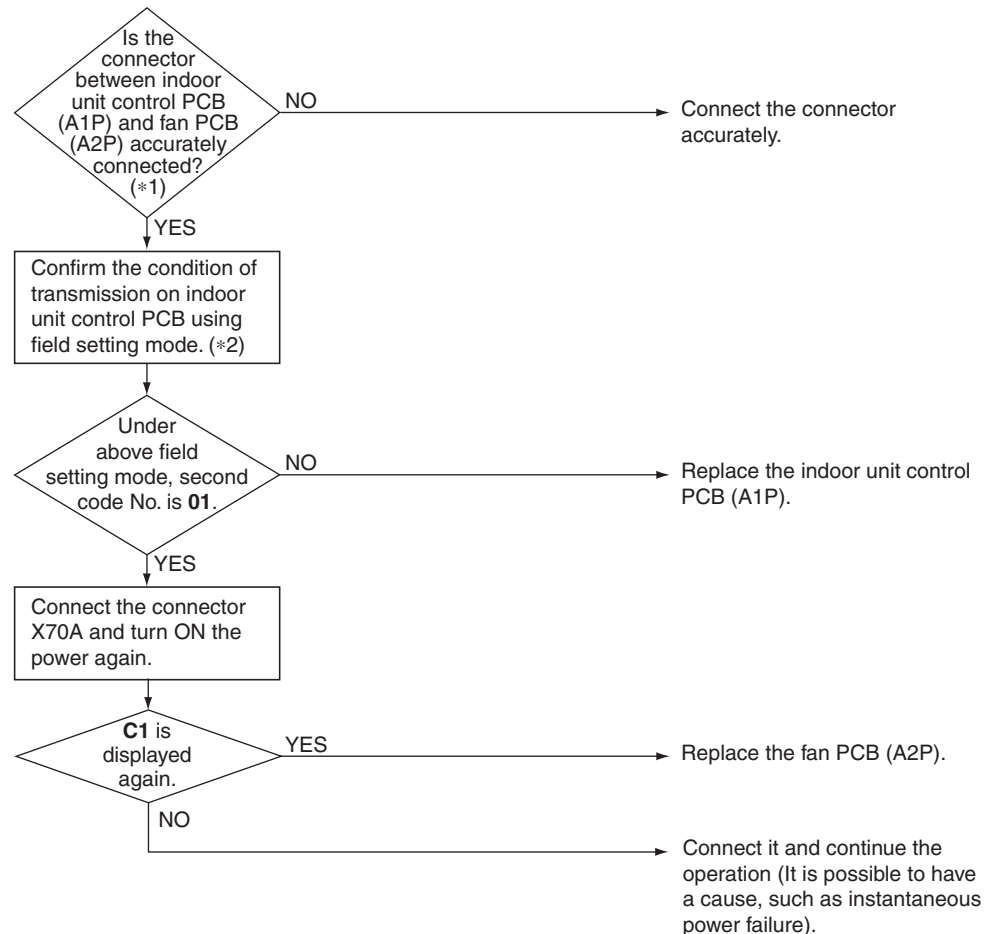
**Note(s)**

\*1. Pull out and insert the connector once and check if it is absolutely connected.

\*2. Method to check transmission part of indoor unit control PCB.

(1) Turn OFF the power and remove the connector X70A of indoor unit control PCB (A1P).

(2) Short circuit X70A.

(3) After turning ON the power, check below numbers under field setting from remote controller.

(Confirmation: Second code No. at the condition of first code No. 21 on mode No. 41)

Determination      01: Normal

Other than 01: Transmission error on indoor unit control PCB

\* After confirmation, turn OFF the power, take off the short circuit and connect X70A back to original condition.

## 3.22 Blower Motor Communication Error

---

<b>Applicable Models</b>	FXTQ-TA, FXTQ-TB
<b>Error Code</b>	<b>C1-07</b>
<b>Outline</b>	Error is issued if transmission abnormalities occur between indoor unit and fan motor.
<b>Error Decision Conditions</b>	If the response message from the fan motor is an abnormal message, and determined as such by the indoor unit, the indoor unit will execute a retry. If everything fails for 5 seconds, it is deemed to be a transmission abnormality.
<b>Error Reset Conditions</b>	If the indoor unit receives even a single normal response message from the fan motor, the error will be cleared.
<b>Supposed Causes</b>	<ul style="list-style-type: none"><li>■ Incorrect or loose wiring</li><li>■ Power interruption (low voltage)</li></ul>
<b>Corrective Actions</b>	<ul style="list-style-type: none"><li>■ Check wiring or tighten wiring connections if needed.</li><li>■ Verify the input voltage at the motor.</li><li>■ Replace the indoor unit PCB or motor.</li></ul>

## 3.23 Climate Talk Communication Error

**Applicable Models**

CXTQ-TA

**Error Code**

**C1-08**

**Method of Error Detection**

Monitors the communication with the gas furnace connected to the Climate Talk Communication terminal.

**Error Reset Conditions**

The error decision is made when the communication with the gas furnace is lost after once the initial setting for communication with the gas furnace completes.

**Supposed Causes**

- Disconnection of the communication wire between the CXTQ-TA and the gas furnace
- Power supply to the gas furnace is cut.

**Troubleshooting**

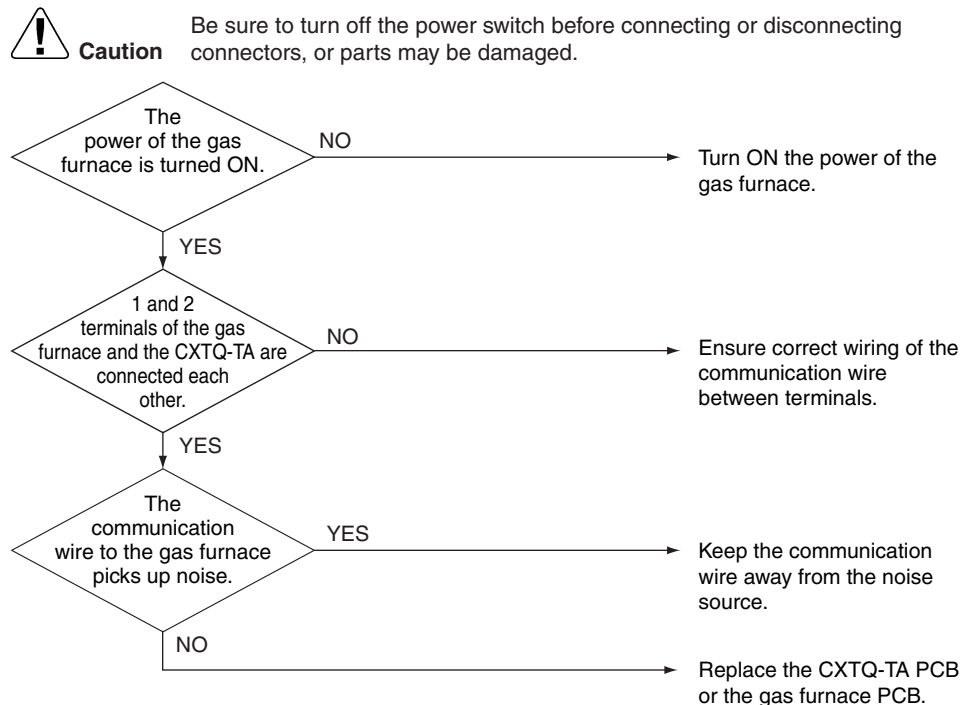

### 3.24 Thermistor Abnormality

<b>Applicable Models</b>	<b>C4, C5:</b> All indoor units <b>C9:</b> except FXTQ-TA, FXTQ-TB, and CXTQ-TA models <b>CA:</b> FXMQ-PB models only
<b>Error Code</b>	<b>C4, C5, C9, CA</b>
<b>Method of Error Detection</b>	The error is determined by the temperature detected by the thermistor.
<b>Error Decision Conditions</b>	The thermistor becomes disconnected or shorted while the unit is running.
<b>Supposed Causes</b>	<ul style="list-style-type: none"> <li>■ Defective thermistor</li> <li>■ Defective indoor unit control PCB</li> <li>■ Defective connector connection</li> <li>■ Broken or disconnected wire</li> </ul>

**Troubleshooting**

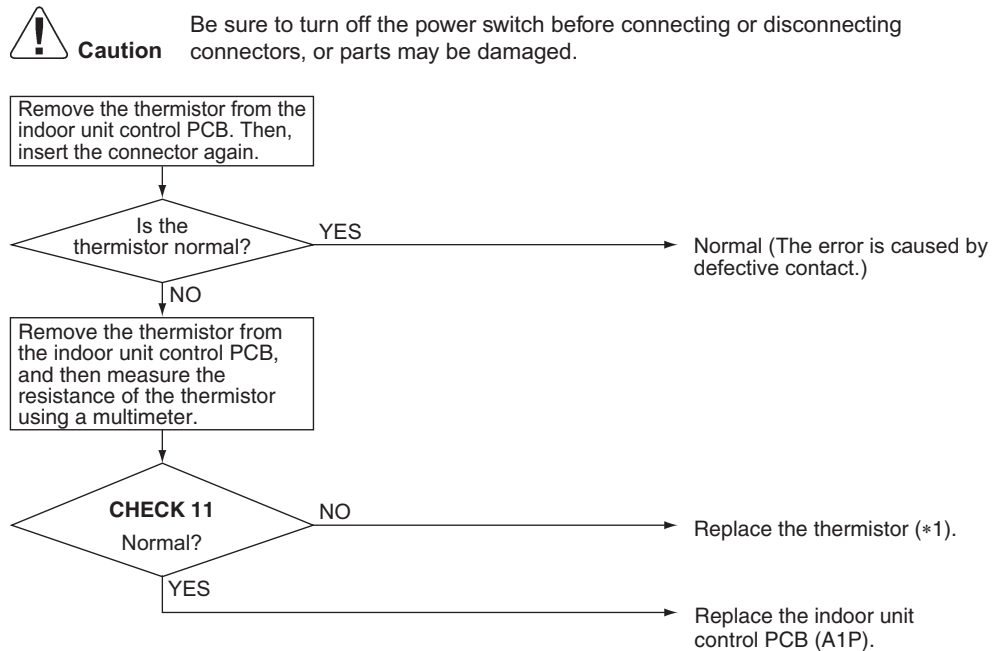

 **Note(s)**

\*1. Error code and thermistor

Error Code	Thermistor	Except FXMQ-PB FXTQ-TA FXTQ-TB CXTQ-TA	FXMQ-PB	FXTQ-TA FXTQ-TB CXTQ-TA
<b>C4</b>	Indoor heat exchanger liquid pipe thermistor	R2T	R2T	R2T
<b>C5</b>	Indoor heat exchanger gas pipe thermistor	R3T	R3T	R3T
<b>C9</b>	Suction air thermistor	R1T	R1T	*2
<b>CA</b>	Discharge air thermistor	—	R4T	—

\*2. Refer to page 358 for **C9** for FXTQ-TA, FXTQ-TB, and CXTQ-TA models.

 **Reference**

**CHECK 11** Refer to page 459.

## 3.25 Combination Error between Indoor Unit Control PCB and Fan PCB

**Applicable Models** FXSQ-TA, FXSQ-TB, FXMQ-PB, FXMQ-TB, FXMQ-TA

**Error Code** **C6**

**Method of Error Detection** Check the condition of transmission with fan PCB (A2P) using indoor unit control PCB (A1P).

**Error Decision Conditions** When the communication data of fan PCB (A2P) is determined as incorrect.

**Supposed Causes**

- Defective fan PCB (A2P)
- Defective connection of capacity setting adaptor
- Field setting error

### Troubleshooting

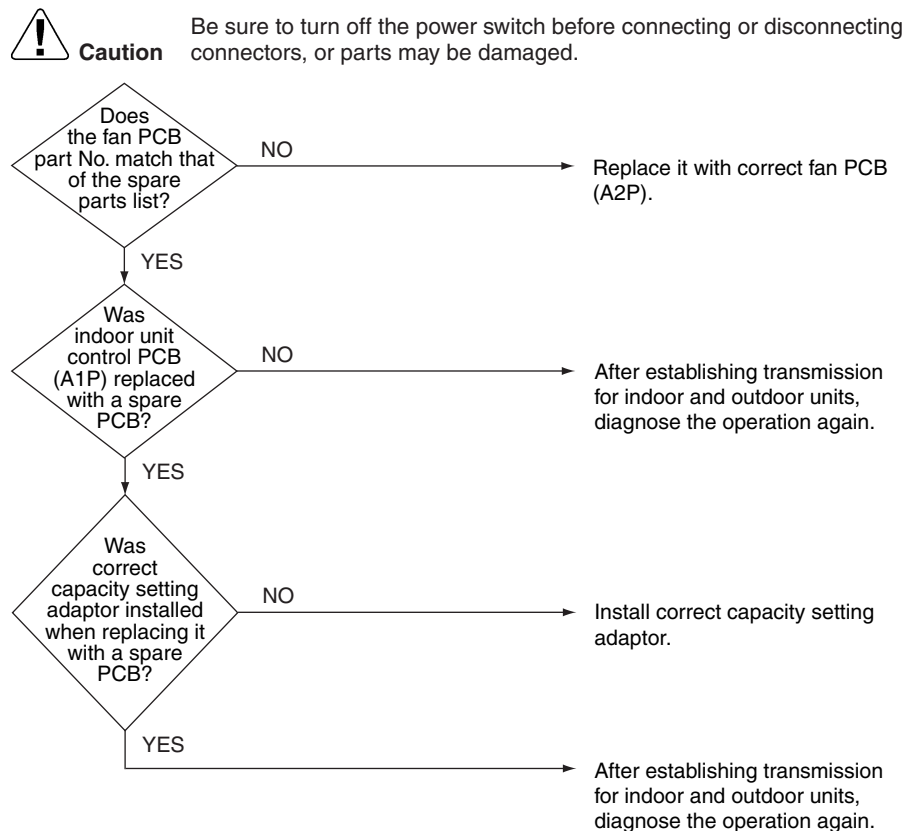

## 3.26 Capacity Setting Abnormality

**Applicable Models**

FXMQ-TA

**Error Code**

**C6-01**

**Method of Error Detection**

This error is detected by checking communication between the PCB (A1P) and the fan microcomputer.

**Error Decision Conditions**

Based on the communication data, decide whether the combination of capacity setting and the type of fan driver is correct.

**Supposed Causes**

- Defective connection of the capacity setting adaptor
- Wrong field setting

**Troubleshooting**



**Caution**

Be sure to turn off the power switch before connecting or disconnecting connectors, or parts may be damaged.

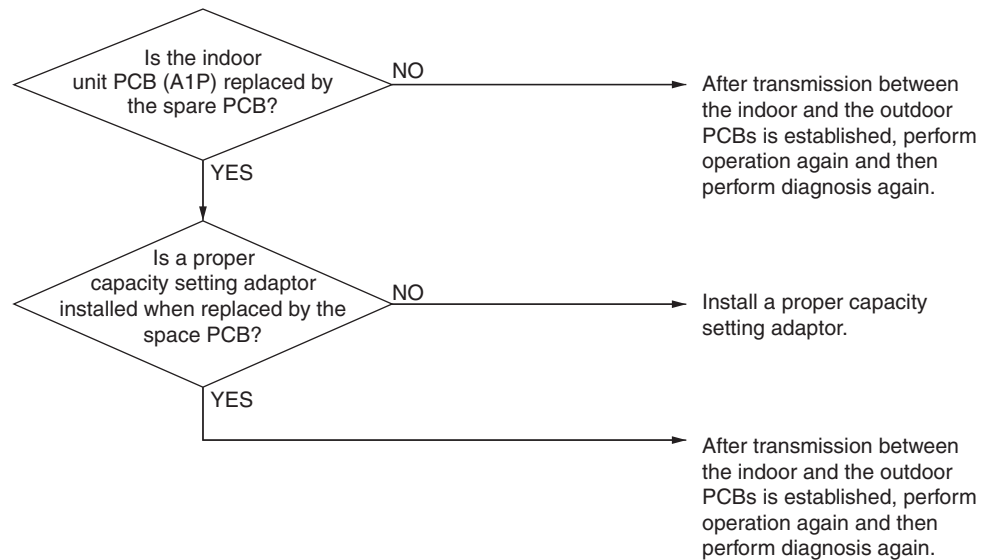

## 3.27 Blower Motor HP Mismatch

---

**Applicable Models** FXTQ-TA, FXTQ-TB

---

**Error Code** **C6-01**

---

**Outline** Error is issued if the manufacturer ID and output of the connected fan motor do not match those recognized by the indoor unit.

---

**Error Decision Conditions** Gathers information on the manufacturer ID and output of the fan motor when initializing the fan motor.  
If those figures are not the values recognized by the indoor unit, it will be deemed abnormal operation.  
If deemed abnormal operation, it will keep retrying until the figures match.

---

**Error Reset Conditions** If the manufacturer ID and output match, the error will be cleared.

---

**Supposed Causes**

- Incorrect size motor
- Indoor unit capacity setting error

---

**Corrective Actions**

- Correct motor installation.
- Correct the indoor unit capacity setting.

## 3.28 Indoor Blower Does Not Have Required Parameters to Function

**Applicable Models**

FXTQ-TA, FXTQ-TB

**Error Code**

**C6-02**

**Outline**

Indoor units perform required settings for control on the fan motor, but if the minimum required settings are not made then information indicating as such will be included among the periodic control status information.  
Error is issued when the information shows abnormality.

**Error Decision Conditions**

If the parameter information shows abnormality, it will be deemed abnormal operation. At that point, parameter settings when initializing the fan motor will be implemented from the beginning.

**Error Reset Conditions**

If the parameter information is normal, the error will be cleared.

**Supposed Causes**

- Locked motor rotor condition

**Corrective Actions**

- Check for locked rotor condition.
- Replace the indoor unit PCB or motor.



### 3.29 Remote Sensor Abnormality

**Applicable Models** FXTQ-TA, FXTQ-TB, CXTQ-TA

**Error Code** **C9**

**Method of Error Detection** The error is detected by remote sensor temperature.

**Error Decision Conditions** When the remote sensor becomes disconnected or shorted while the unit is running.

- Supposed Causes**
- Defective indoor unit thermistor (R1T) for room temperature
  - Defective indoor unit PCB

**Troubleshooting**

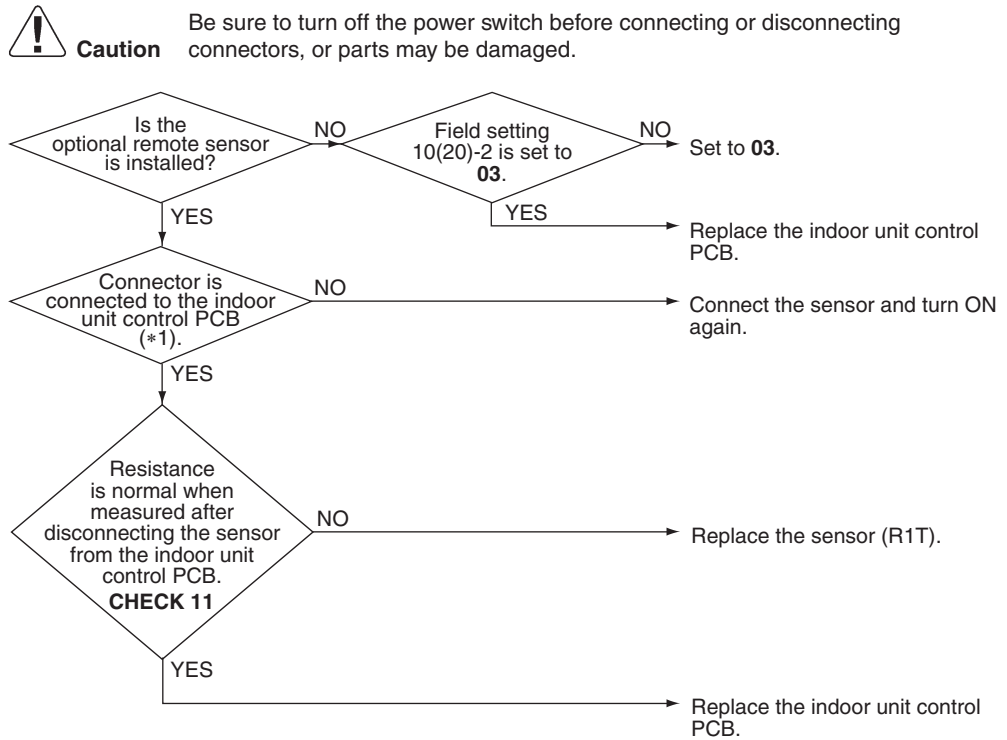

 **Note(s)** \*1. Connector and indoor unit control PCB

Connector for remote sensor	PCB
X4A	A1P

 **Reference** **CHECK 11** Refer to page 459.

### 3.30 Humidity Sensor System Abnormality

<b>Applicable Models</b>	FXFQ-T
<b>Error Code</b>	<b>CC</b>
<b>Method of Error Detection</b>	Even if an error occurs, operation still continues. Error is detected according to the moisture (output voltage) detected by the moisture sensor.
<b>Error Decision Conditions</b>	When the moisture sensor is disconnected or short circuited
<b>Supposed Causes</b>	<ul style="list-style-type: none"> <li>■ Defective sensor</li> <li>■ Disconnection</li> </ul>

**Troubleshooting**



**Caution** Be sure to turn off the power switch before connecting or disconnecting connectors, or parts may be damaged.

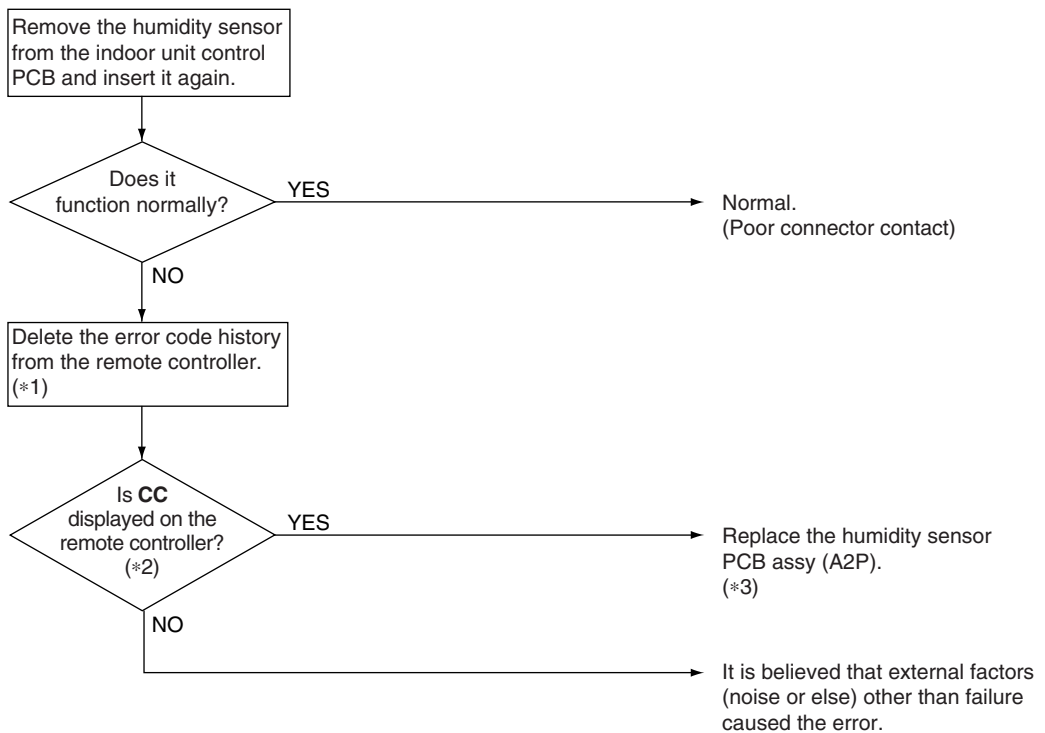

**Note(s)**

- \*1. To delete the history, the **ON/OFF** button of the remote controller must be pressed and held for 5 seconds in the check mode.
- \*2. To display the code, the **INSPECTION/TEST** button of the remote controller must be pressed and held in the normal mode.
- \*3. If **CC** is displayed even after replacing the humidity sensor PCB (A2P) and taking the steps \*1 and \*2, replace the indoor unit control PCB (A1P).

### 3.31 Infrared Presence/Floor Sensor Error

**Applicable Models** FXFQ-AA, FXFQ-T, FXZQ-TA, FXZQ-TB, FXUQ-P, FXUQ-PA

**Error Code** **CE**

**Method of Error Detection** The contents of a failure vary with the detailed error code. Check the code and proceed with the flowchart.

**Error Decision Conditions** Error is detected based on sensor output signals

**Supposed Causes**

- Defective or disconnected infrared presence sensor connector: **CE-01**
- Defective infrared floor sensor (Temperature compensation circuit disconnection): **CE-02**
- Defective infrared floor sensor (Temperature compensation short circuit): **CE-03**
- Defective infrared floor sensor element: **CE-04**

#### Troubleshooting



**Caution**

Be sure to turn off the power switch before connecting or disconnecting connectors, or parts may be damaged.

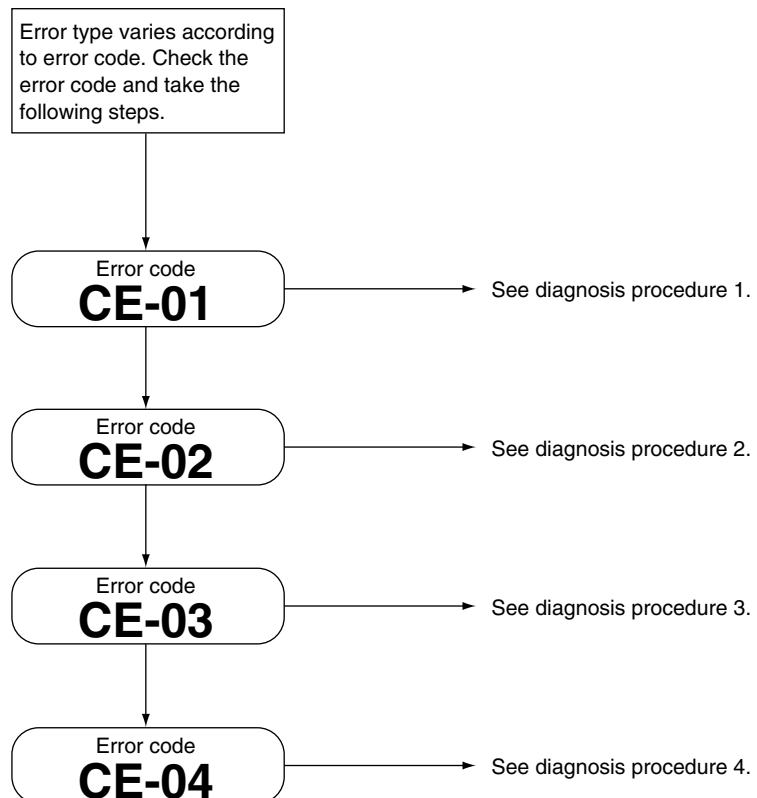

Diagnosis procedure 1

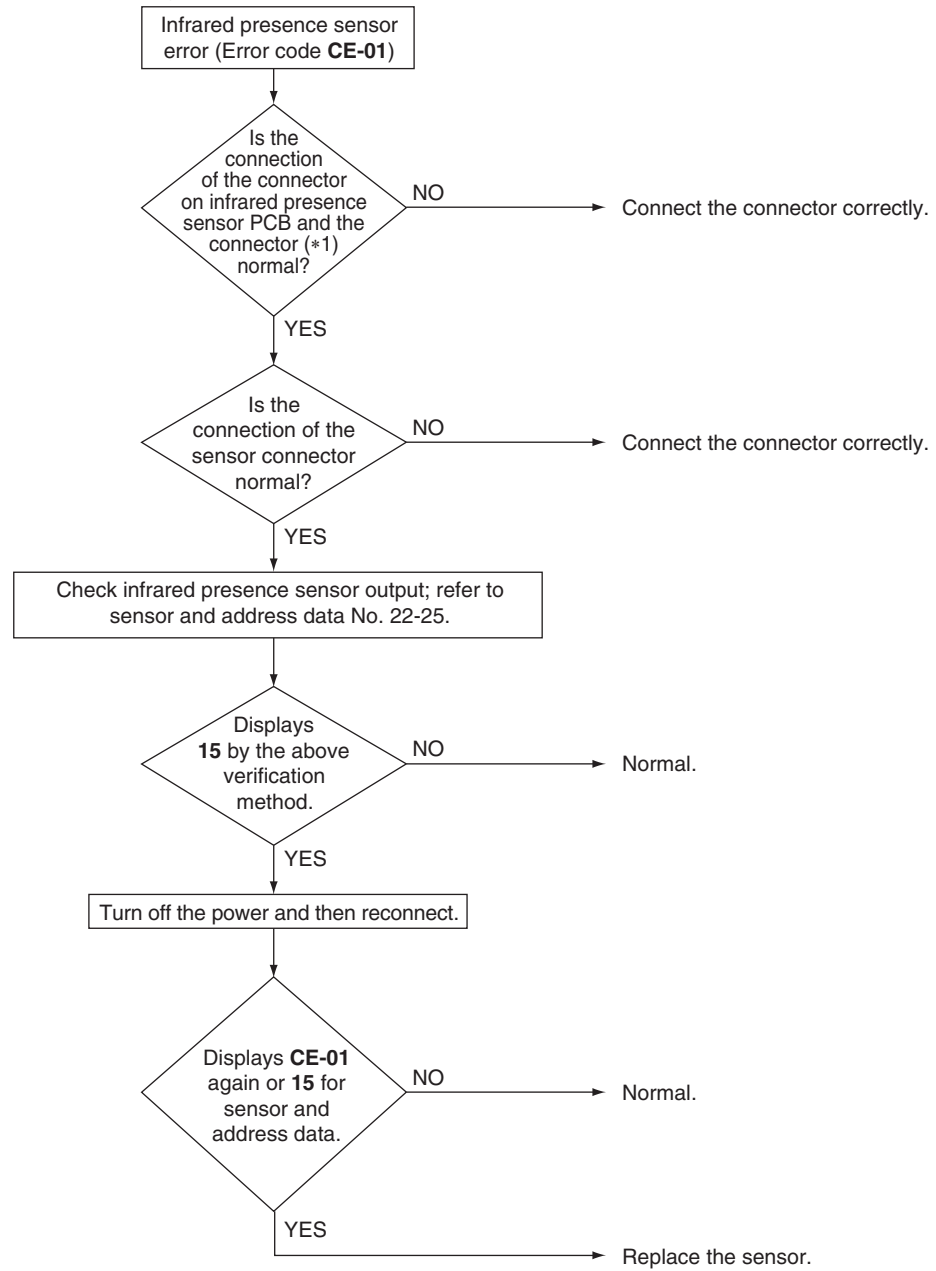

Note(s)

\*1. Infrared presence sensor PCB and connector

Model	Infrared presence sensor PCB	Connector
FXFQ-AA	A3P	X81A (A1P)
FXFQ-T	A4P	X2A (A2P)
FXZQ-TA	A5P	X110A (A6P)
FXZQ-TB	A5P	X81A (A1P)
FXUQ-P	A4P	X81A (A1P)
FXUQ-PA	A4P	X81A (A1P)

## Diagnosis procedure 2

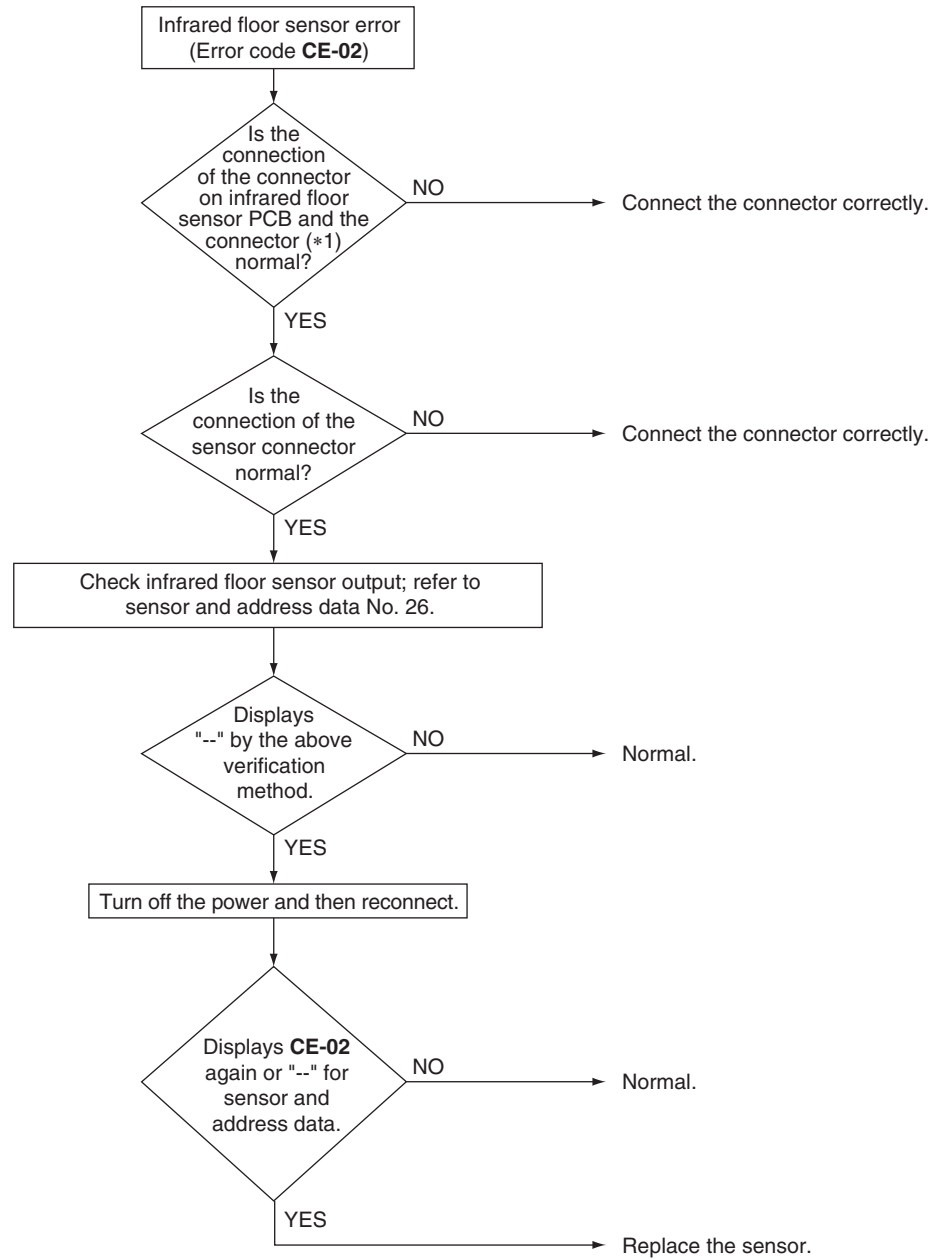

### Note(s)

\*1. Infrared floor sensor PCB and connector

Model	Infrared floor sensor PCB	Connector
FXFQ-AA	A2P	X81A (A1P)
FXFQ-T	A3P	X2A (A2P)
FXZQ-TA	A4P	X110A (A6P)
FXZQ-TB	A4P	X81A (A1P)
FXUQ-P	A3P	X81A (A1P)
FXUQ-PA	A3P	X81A (A1P)

Diagnosis procedure 3

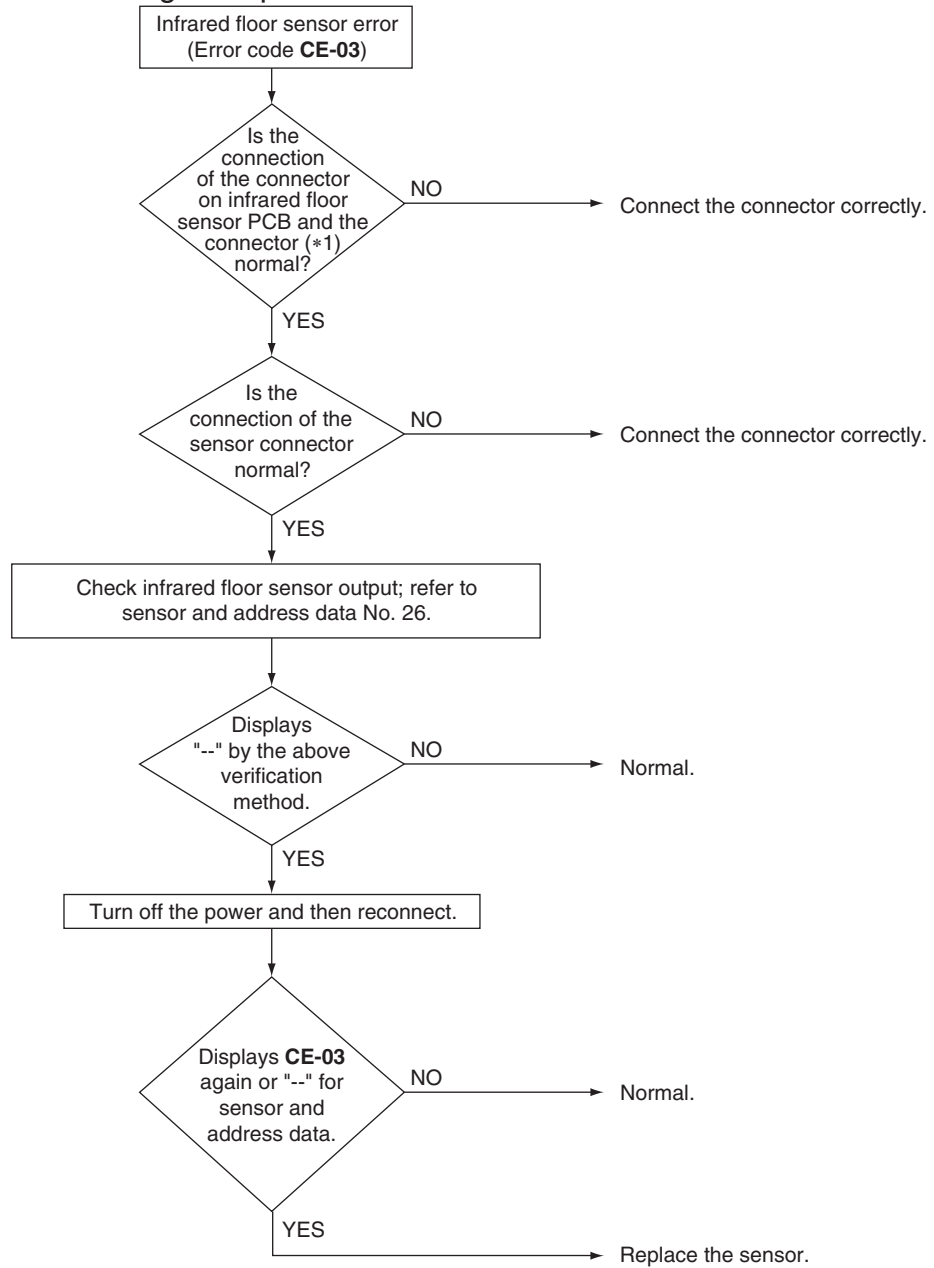

Note(s)

\*1. Infrared floor sensor PCB and connector

Model	Infrared floor sensor PCB	Connector
FXFQ-AA	A2P	X81A (A1P)
FXFQ-T	A3P	X2A (A2P)
FXZQ-TA	A4P	X110A (A6P)
FXZQ-TB	A4P	X81A (A1P)
FXUQ-P	A3P	X81A (A1P)
FXUQ-PA	A3P	X81A (A1P)

## Diagnosis procedure 4

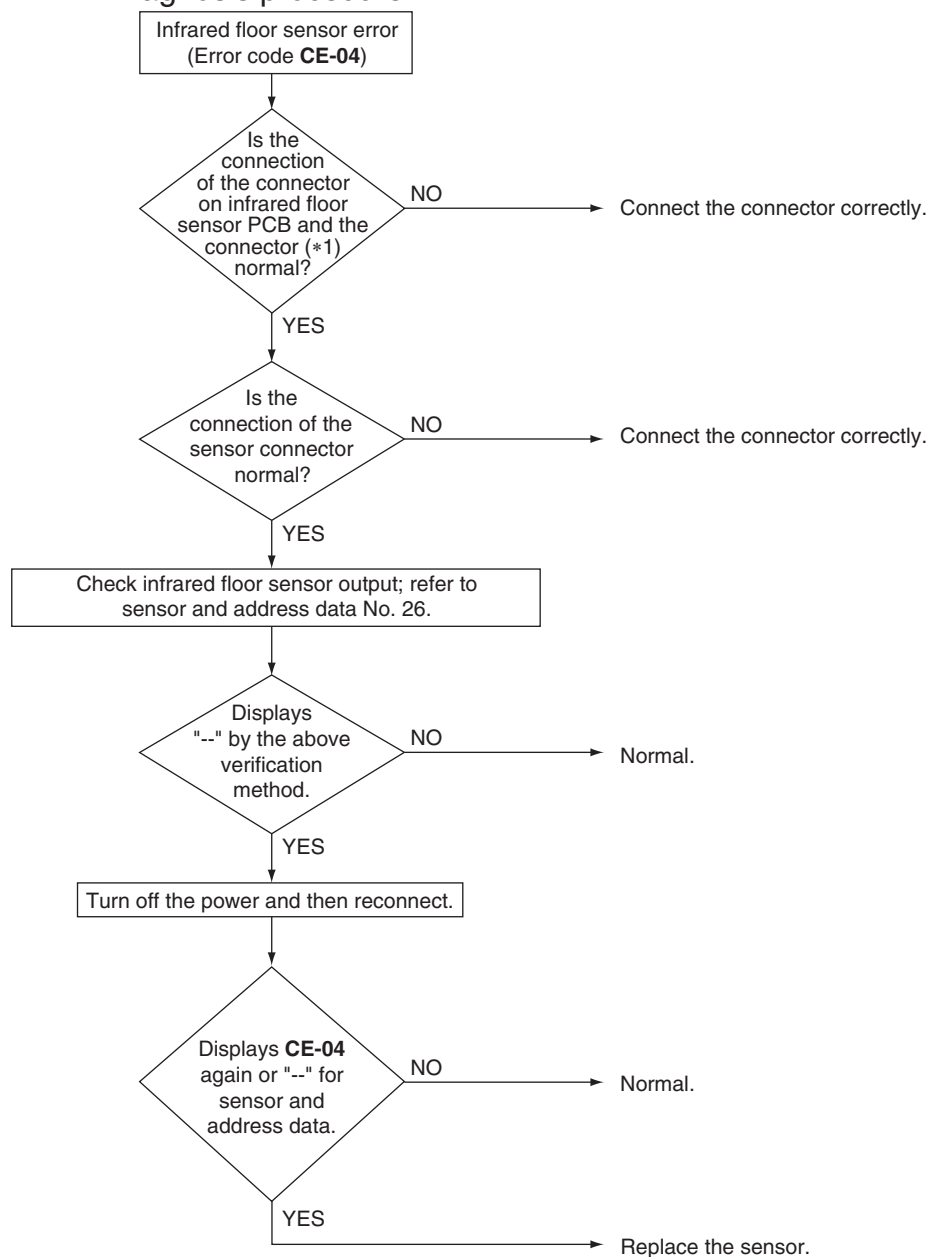

## Note(s)

\*1. Infrared floor sensor PCB and connector

Model	Infrared floor sensor PCB	Connector
FXFQ-AA	A2P	X81A (A1P)
FXFQ-T	A3P	X2A (A2P)
FXZQ-TA	A4P	X110A (A6P)
FXZQ-TB	A4P	X81A (A1P)
FXUQ-P	A3P	X81A (A1P)
FXUQ-PA	A3P	X81A (A1P)

### 3.32 Remote Controller Thermistor Abnormality

<b>Applicable Models</b>	All indoor unit models
<b>Error Code</b>	<b>CJ</b>
<b>Method of Error Detection</b>	Error detection is carried out by the temperature detected by the remote controller thermistor.
<b>Error Decision Conditions</b>	The remote controller thermistor becomes disconnected or shorted while the unit is running. * Error code is displayed but the system operates continuously.
<b>Supposed Causes</b>	<ul style="list-style-type: none"> <li>■ Defective remote controller thermistor</li> <li>■ Defective remote controller PCB</li> </ul>

**Troubleshooting**

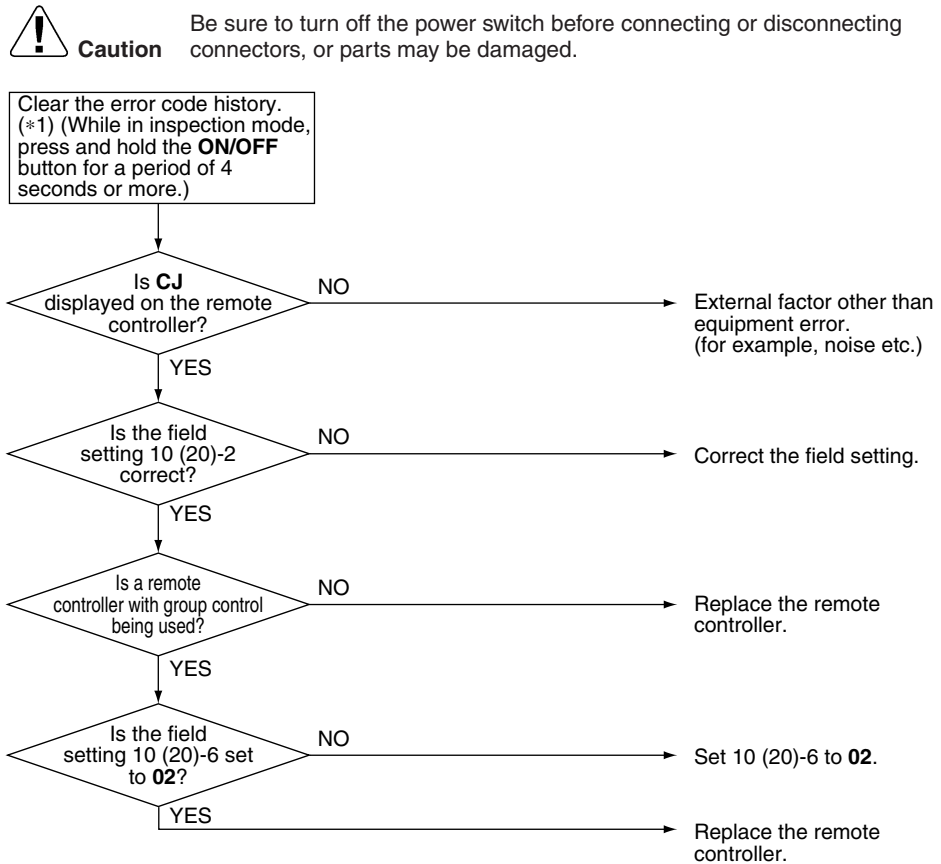

 **Note(s)** \*1: How to delete the history of error codes. Press the **ON/OFF** button for 4 seconds and more while the error code is displayed in the inspection mode.



### 3.33 Outdoor Unit Main/Sub PCB Abnormality

<b>Applicable Models</b>	All outdoor unit models
<b>Error Code</b>	<b>E1</b>
<b>Method of Error Detection</b>	Abnormality is detected under the communication conditions in the hardware section between the indoor unit and outdoor unit.
<b>Error Decision Conditions</b>	When the communication conditions in the hardware section between the indoor unit and the outdoor unit are not normal.
<b>Supposed Causes</b>	<ul style="list-style-type: none"> <li>■ Defective outdoor unit main PCB (A1P)</li> <li>■ Defective outdoor unit sub PCB (A8P)</li> <li>■ Defective connection communication line between indoor and outdoor units</li> </ul>

#### Troubleshooting

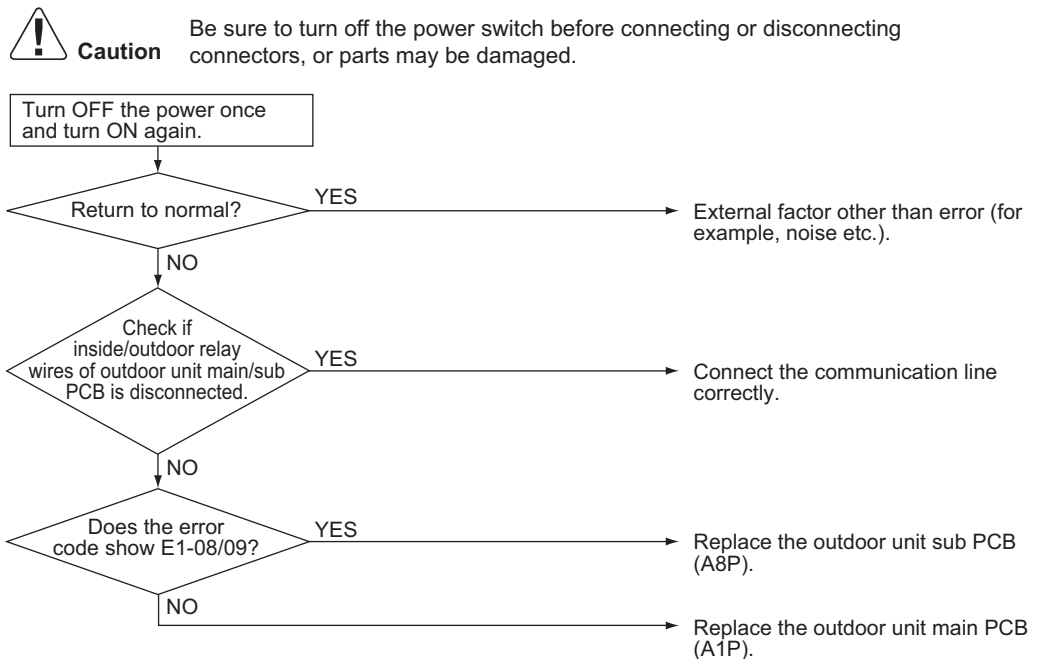

### 3.34 Detection of Ground Leakage by Leak Detection Circuit

**Applicable Models** All outdoor unit models

**Error Code** **E2**

Sub code: 01, 02

**Method of Error Detection** Detect leakage current in the ground leakage detection circuit and detect error on the outdoor unit main PCB.

**Error Decision Conditions** The leakage current is detected.

- Supposed Causes**
- Ground fault
  - Improper wiring passing through the current sensor
  - Temporary liquid compression or melting in compressor

**Troubleshooting**



**Caution** Be sure to turn off the power switch before connecting or disconnecting connectors, or parts may be damaged.

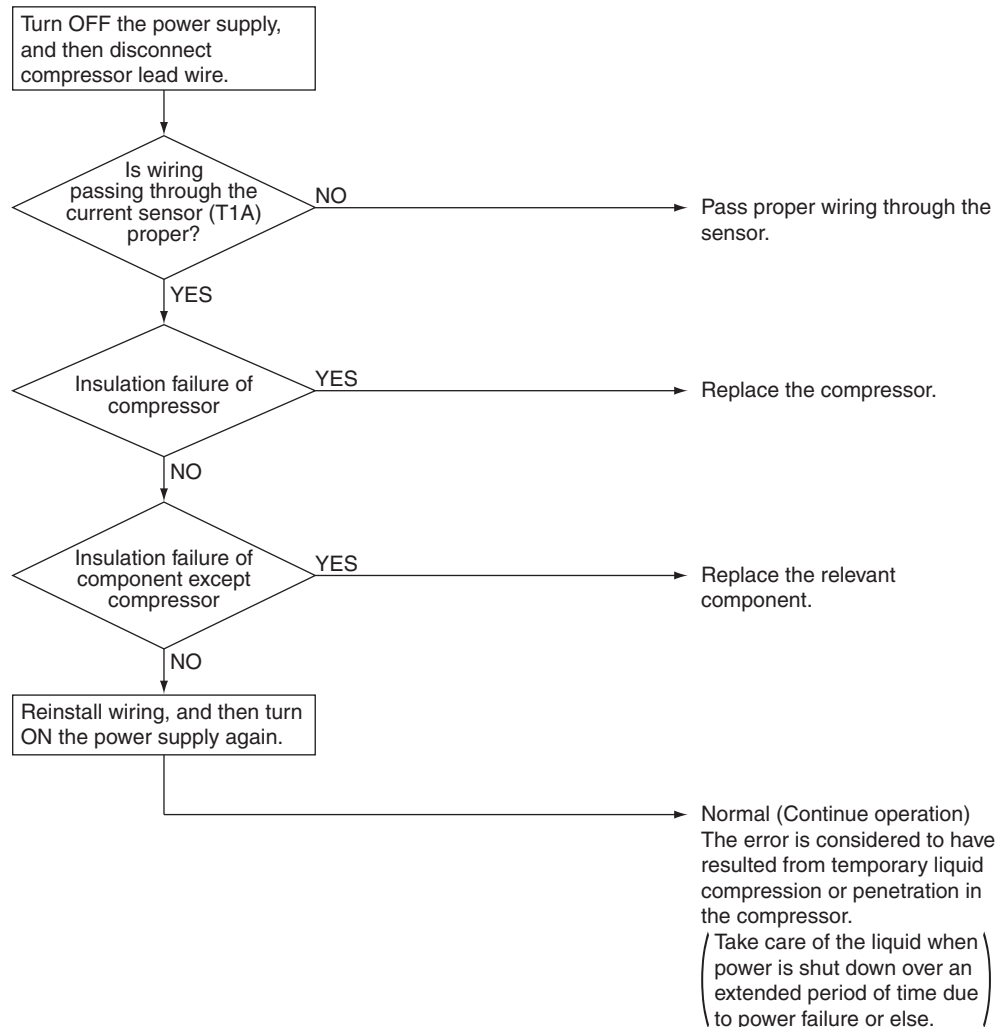

## 3.35 Missing of Ground Leakage Detection Core

**Applicable Models** All outdoor unit models

**Error Code** **E2**

Sub code: 06, 07

**Method of Error Detection** Error is detected according to whether or not there is continuity across the connector X101A for leakage detection circuit (Q1LD).

**Error Decision Conditions** No current flows at the time of turning ON the power supply.

**Supposed Causes**

- Disconnection of connector X101A
- Wiring disconnection
- Defective outdoor unit main PCB

### Troubleshooting



**Caution**

Be sure to turn off the power switch before connecting or disconnecting connectors, or parts may be damaged.

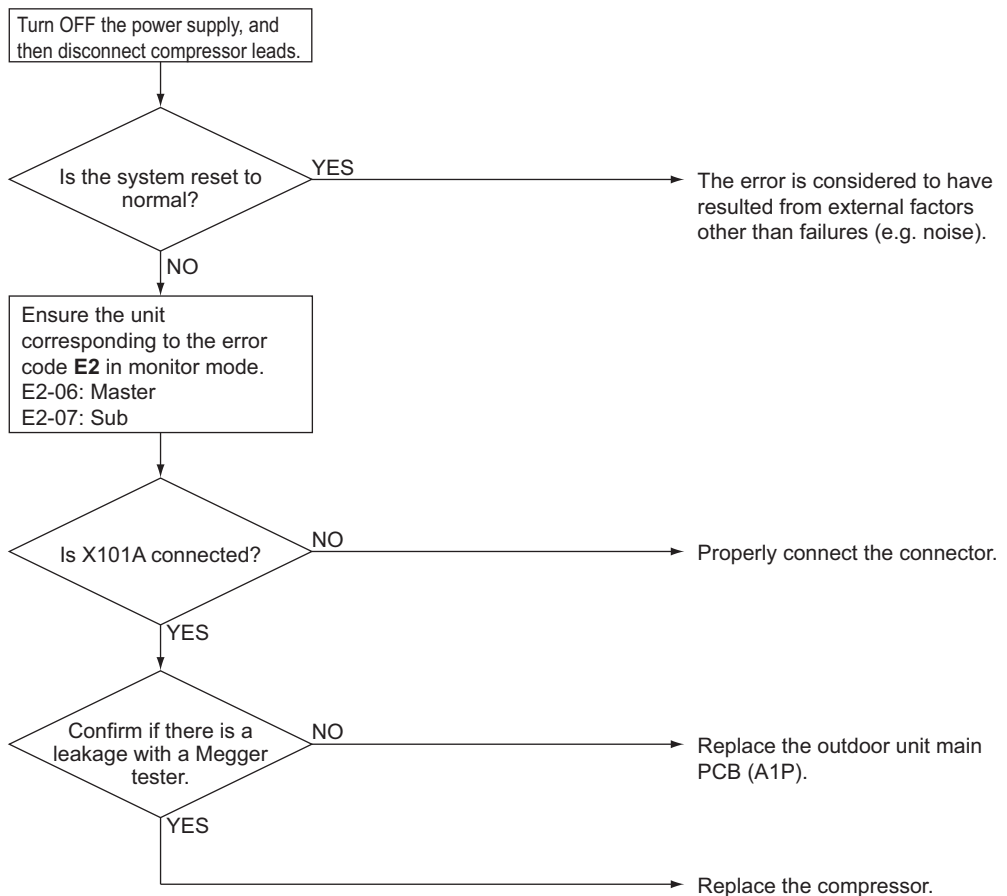

### 3.36 Activation of High Pressure Switch

<b>Applicable Models</b>	All outdoor unit models
<b>Error Code</b>	<b>E3</b>
<b>Method of Error Detection</b>	Detect continuity across the high pressure switch in the protection device circuit.
<b>Error Decision Conditions</b>	When part of the protection device circuit opens. (Reference) Operating pressure of the high pressure switch: <ul style="list-style-type: none"> <li>■ Operating pressure: 4.0 MPa (580 psi)</li> <li>■ Resetting pressure: 3.0 MPa (435 psi)</li> </ul>
<b>Supposed Causes</b>	<ul style="list-style-type: none"> <li>■ Activation of high pressure switch</li> <li>■ Defective high pressure switch</li> <li>■ Defective outdoor unit main PCB (A1P)</li> <li>■ Momentary power failure</li> <li>■ Defective high pressure sensor</li> </ul>

**Troubleshooting**

 **Caution** Be sure to turn off the power switch before connecting or disconnecting connectors, or parts may be damaged.

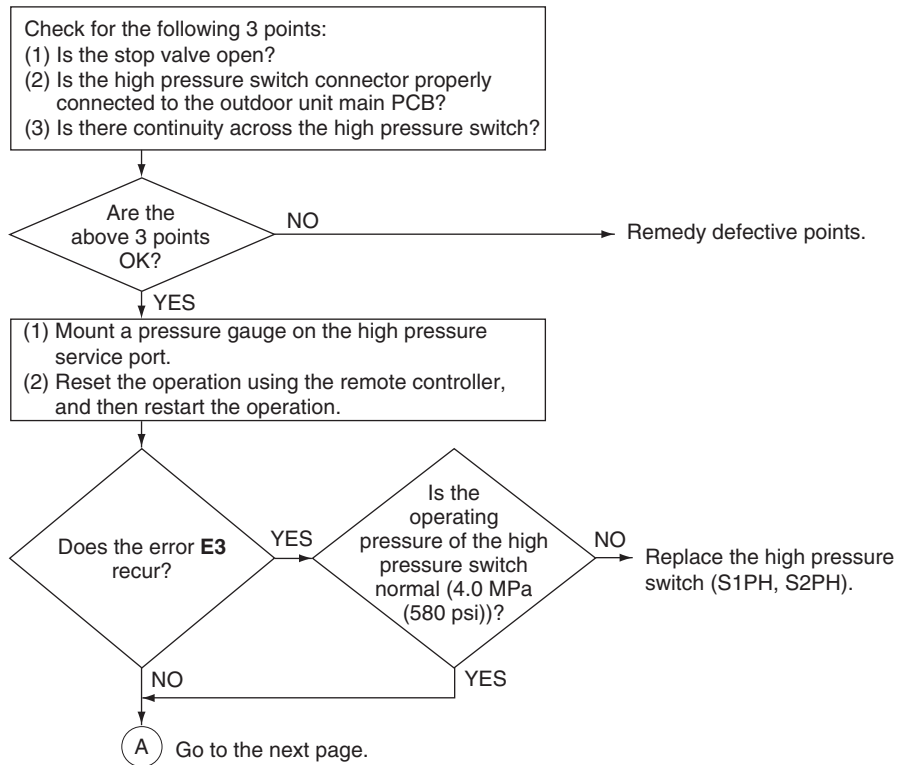

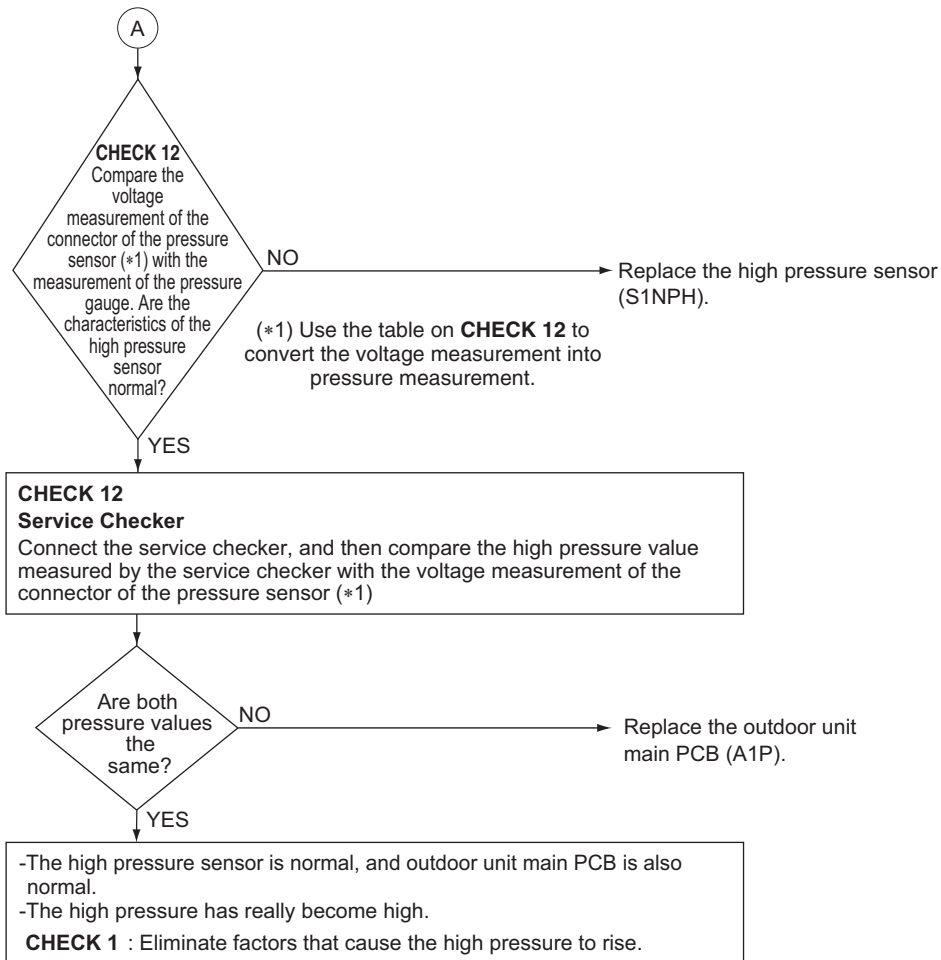

Reference

**CHECK 1** Refer to page 449.

Reference

**CHECK 12** Refer to page 463.

### 3.37 Activation of Low Pressure Sensor

<b>Applicable Models</b>	All outdoor unit models
<b>Error Code</b>	<b>E4</b>
<b>Method of Error Detection</b>	Make judgment of pressure detected by the low pressure sensor with the outdoor unit main PCB.
<b>Error Decision Conditions</b>	When low pressure caused a drop while the compressor is in operation: <ul style="list-style-type: none"> <li>■ Operating pressure: 0.07 MPa (10.2 psi)</li> </ul>
<b>Supposed Causes</b>	<ul style="list-style-type: none"> <li>■ Abnormal drop in low pressure</li> <li>■ Defective low pressure sensor</li> <li>■ Defective outdoor unit main PCB</li> <li>■ The stop valve is not opened</li> </ul>

**Troubleshooting**

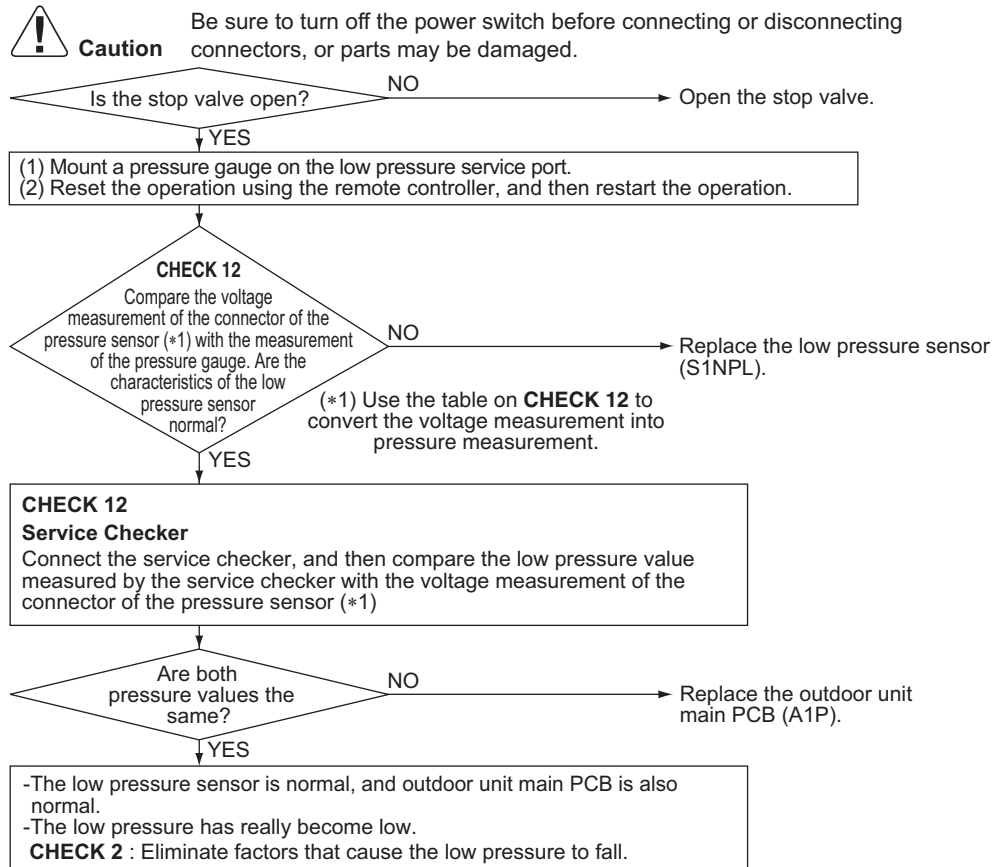

**Reference** CHECK 2 Refer to page 450.

**Reference** CHECK 12 Refer to page 463.

## 3.38 Compressor Motor Lock

**Applicable Models** All outdoor unit models

**Error Code** **E5**

**Method of Error Detection** Inverter PCB takes the position signal from UVW line connected between the inverter and compressor, and the error is detected when any abnormality is observed in the phase-current waveform.

**Error Decision Conditions** This error will be output when the compressor motor does not start up even in forced startup mode.

- Supposed Causes**
- Compressor lock
  - High differential pressure (0.5 MPa (72.5 psi) or more)
  - UVW connection error
  - Defective inverter PCB
  - Stop valve is not opened

### Troubleshooting



**Caution**

Be sure to turn off the power switch before connecting or disconnecting connectors, or parts may be damaged.

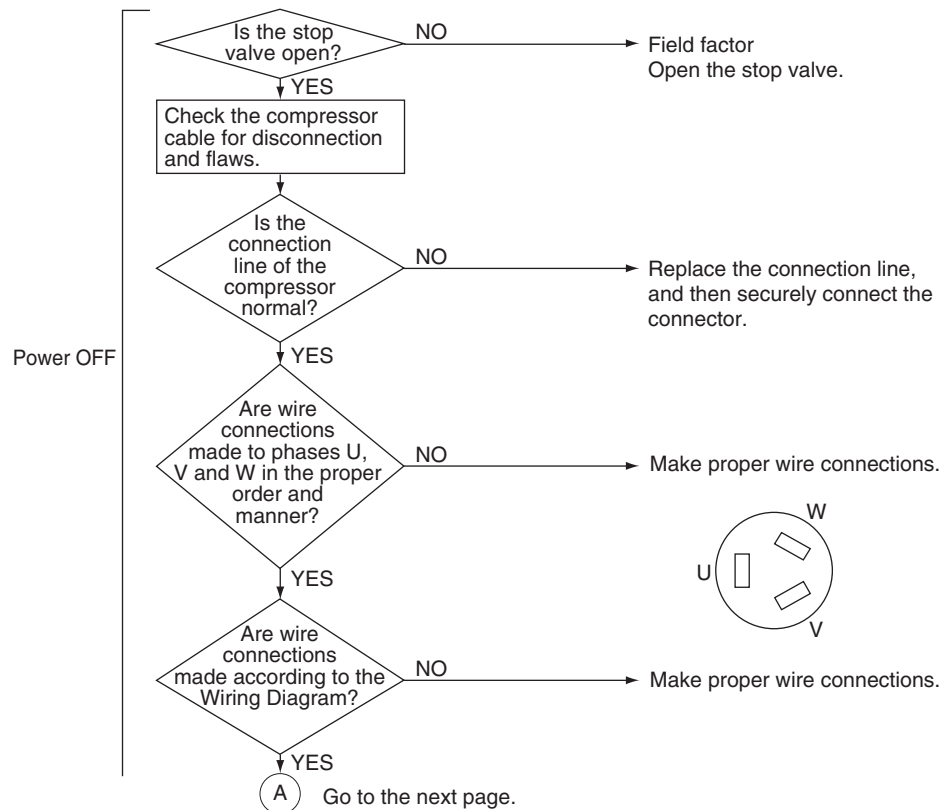

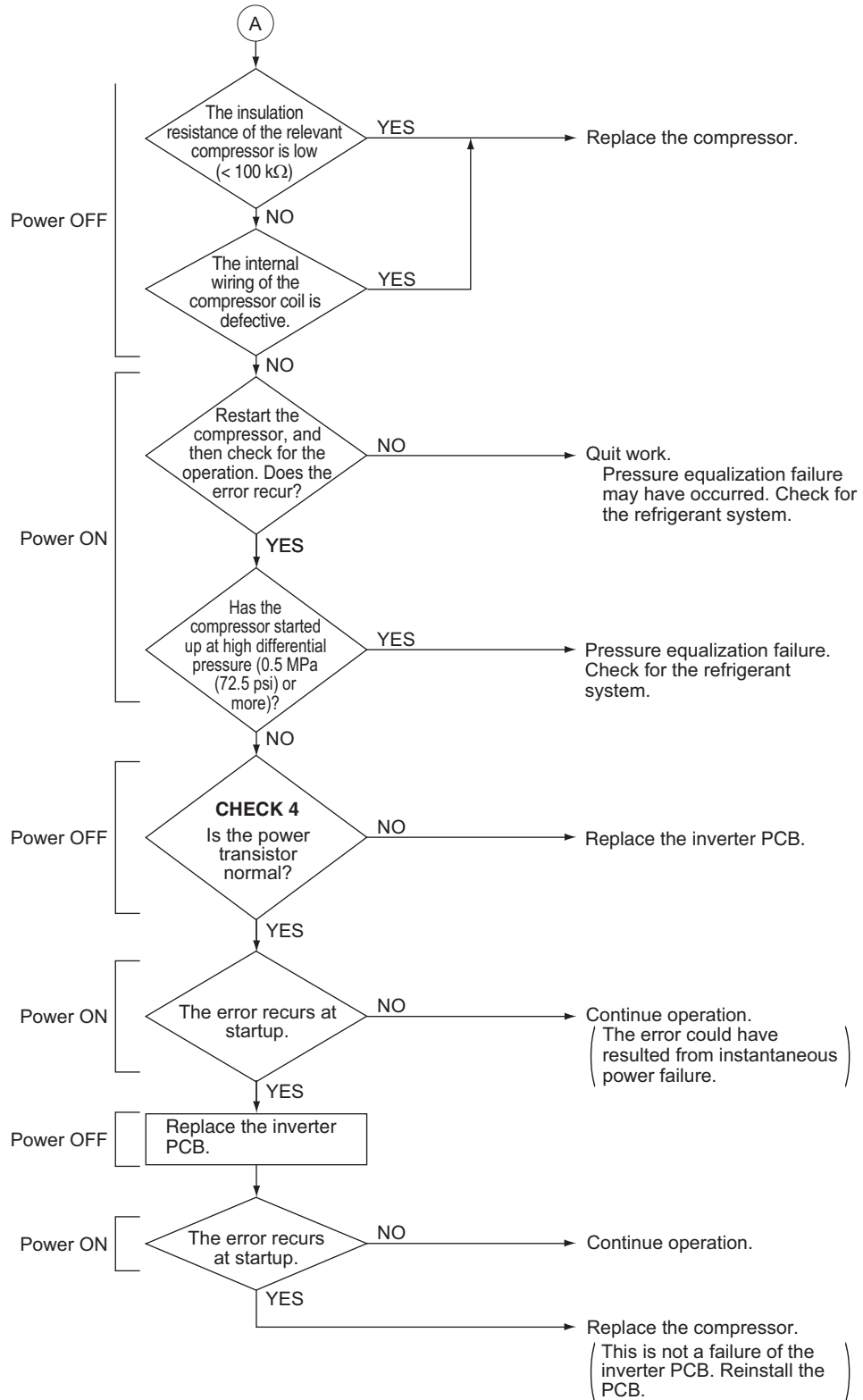

Reference CHECK 4 Refer to page 454.



## 3.39 Compressor Damage Alarm

**Applicable Models** All outdoor unit models

**Error Code** **E6**

**Method of Error Detection** Determine the symptom to be error by detecting the revolutions of the compressor and pressure values detected by the high and low pressure sensors, and further making a comparison between a theoretical current value of the compressor calculated from parameters detected and an actual current value detected by the power transistor.

**Error Decision Conditions** When a state in which the actual current value of the compressor is abnormally high (by 130% or more) compared to the theoretical current value continues for a period of 30 minutes.  
\* In case of a system with multi outdoor units, the system will return an alarm if there is any operational unit other than that applicable to **E6** or determine to be error if not.

**Supposed Causes**

- Defective compressor
- Defective high pressure sensor
- Defective low pressure sensor
- Defective outdoor unit main PCB
- Defective inverter PCB

### Troubleshooting



**Caution**

Be sure to turn off the power switch before connecting or disconnecting connectors, or parts may be damaged.

(1) Mount a pressure gauge on the high and low pressure service ports.  
(2) Reset the power supply, and then restart the operation.

Are the characteristics of the high pressure sensor normal? (\*1)

NO

Replace the high pressure sensor (S1NPH).

YES

Are the characteristics of the low pressure sensor normal? (\*1)

NO

Replace the low pressure sensor (S1NPL).

YES

**CHECK 12 Service Checker**  
Connect the service checker to compare the high pressure and low pressure checked by the service checker and the actual measured values of the high and low pressure sensors. (\*1)

A

Go to the next page.

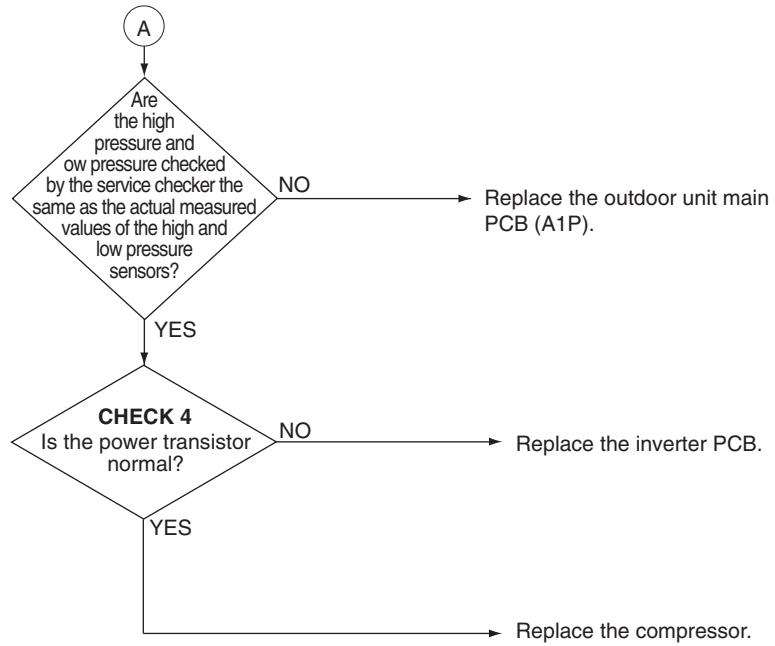

 **Reference**    **CHECK 4** Refer to page 454.

 **Reference**    **CHECK 12** Refer to page 463.

## 3.40 Outdoor Fan Motor Abnormality

<b>Applicable Models</b>	All outdoor unit models
<b>Error Code</b>	<b>E7</b>
<b>Method of Error Detection</b>	Detects according to the value of current flowing through the fan PCB.
<b>Error Decision Conditions</b>	<ul style="list-style-type: none"> <li>■ Overcurrent is detected from the fan PCB (Detecting overcurrent 4 times will shut down the system).</li> <li>■ Current does not increase at fan motor startup or while the fan motor is in operation (Detecting 4 times will shut down the system).</li> </ul>
<b>Supposed Causes</b>	<ul style="list-style-type: none"> <li>■ Fan motor failure</li> <li>■ Neglect to connect or defective connection of harness/connector between the fan motor and the PCB</li> <li>■ Fan does not rotate due to foreign matter caught in it.</li> <li>■ Clearing condition: fan motor performs normal operation for a period of 5 minutes</li> </ul>

### Troubleshooting

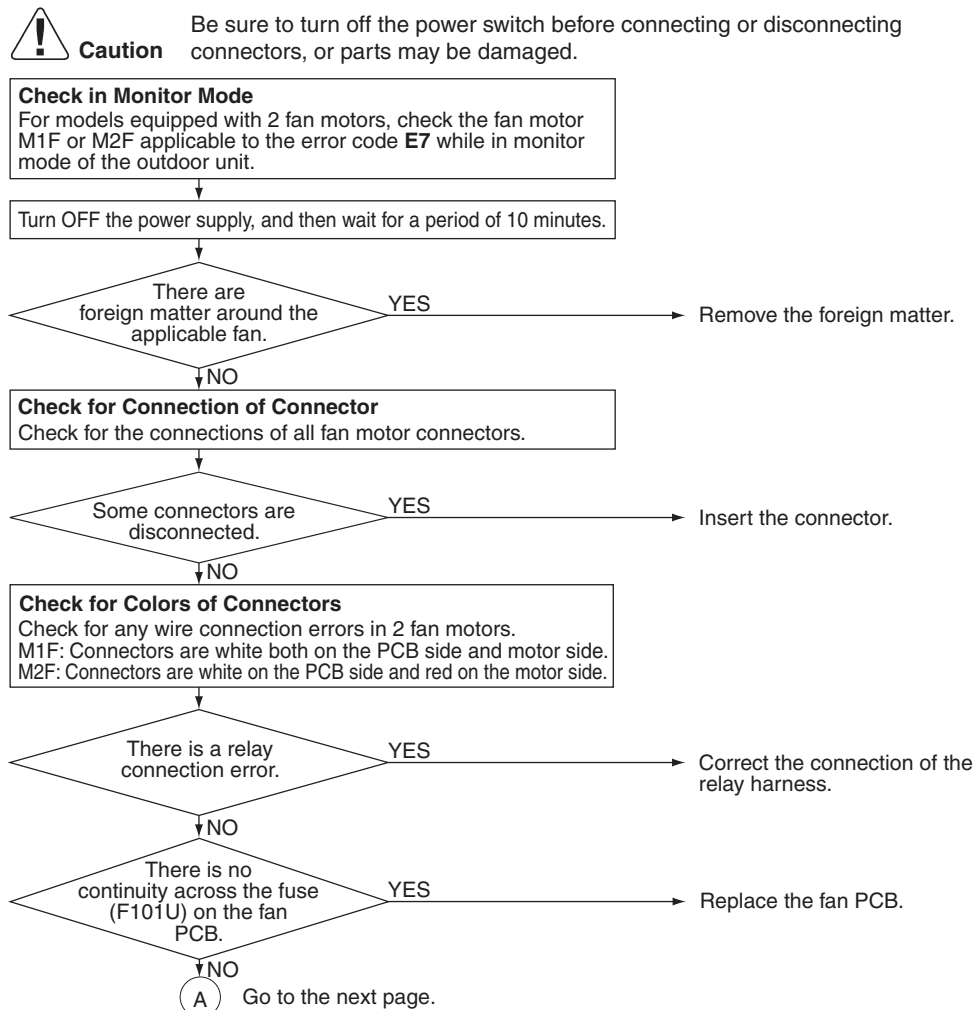

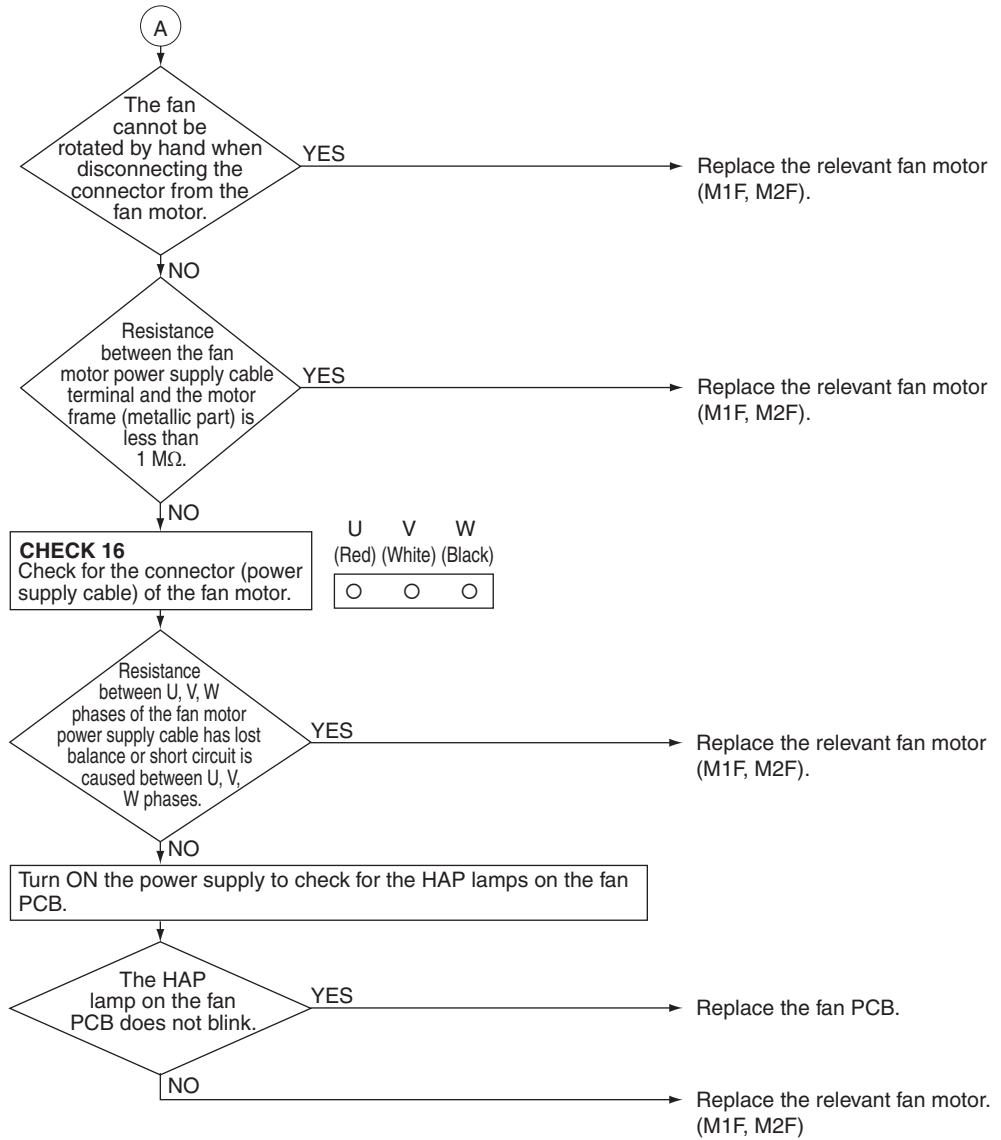

 **Reference**    **CHECK 16** Refer to page 466.

## 3.41 Electronic Expansion Valve Coil Abnormality or Sub PCB Momentary Overcurrent

<b>Applicable Models</b>	All outdoor unit models
<b>Error Code</b>	<b>E9</b>
<b>Method of Error Detection</b>	Detects according to whether or not there is continuity across the electronic expansion valve coils.
<b>Error Decision Conditions</b>	When no current flows through common (COM[+]) at the time of turning ON the power supply.
<b>Supposed Causes</b>	<ul style="list-style-type: none"> <li>■ Disconnection of connectors from electronic expansion valves</li> <li>■ Defective electronic expansion valve coil</li> <li>■ Defective outdoor unit main PCB</li> <li>■ Sub PCB momentary overcurrent</li> </ul>

### Troubleshooting

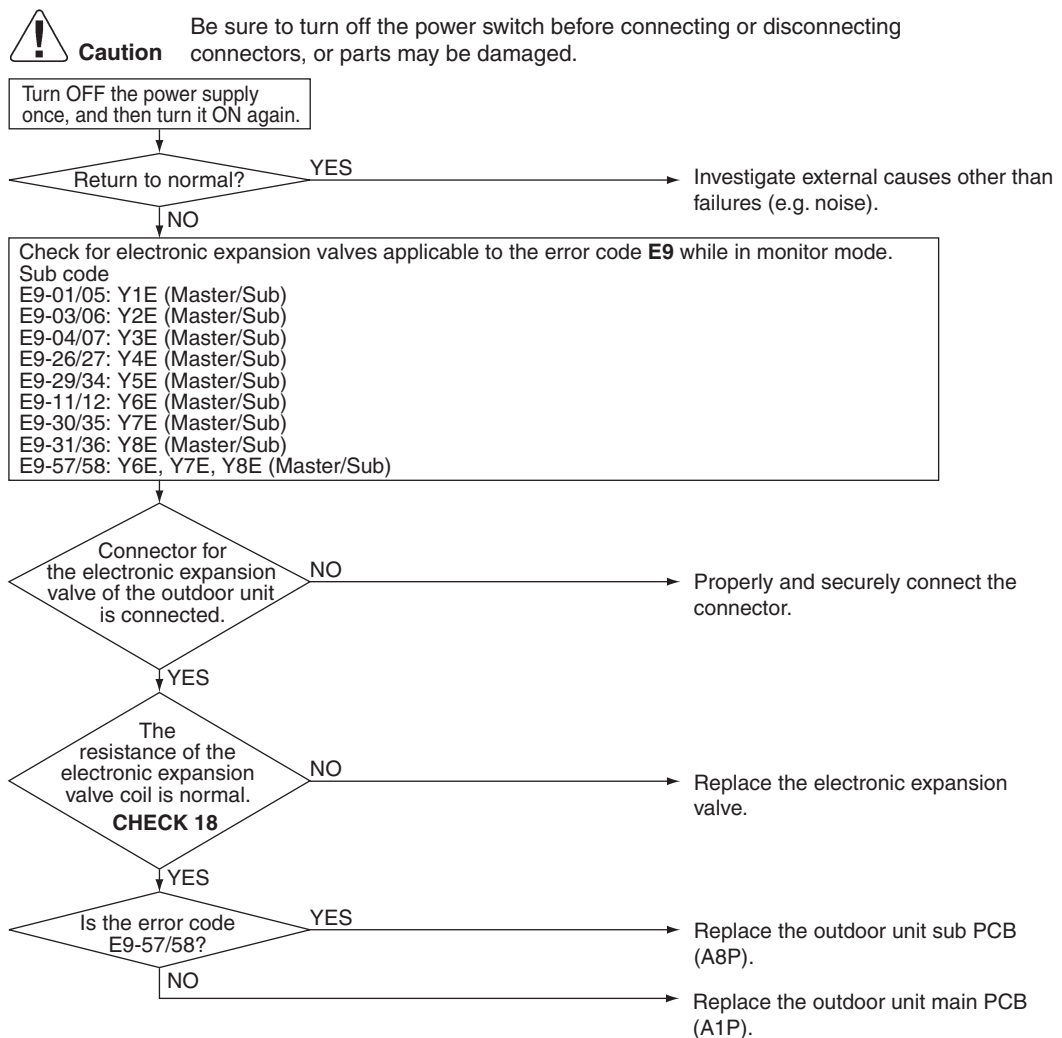

**Reference** **CHECK 18** Refer to page 470.

### 3.42 Four Way Valve Abnormality (Intermediate Stop)

**Applicable Models** All outdoor unit models

**Error Code** **EA**  
Sub code: 02-09

**Method of Error Detection** Detect the intermediate stop of the four way valve according to pressure sensors.

**Error Decision Conditions** When there is no pressure difference between high and low pressure.

- Supposed Causes**
- Defective high pressure sensor
  - Defective low pressure sensor
  - Defective coil or harness of four way valve
  - Defective four way valve

**Troubleshooting**

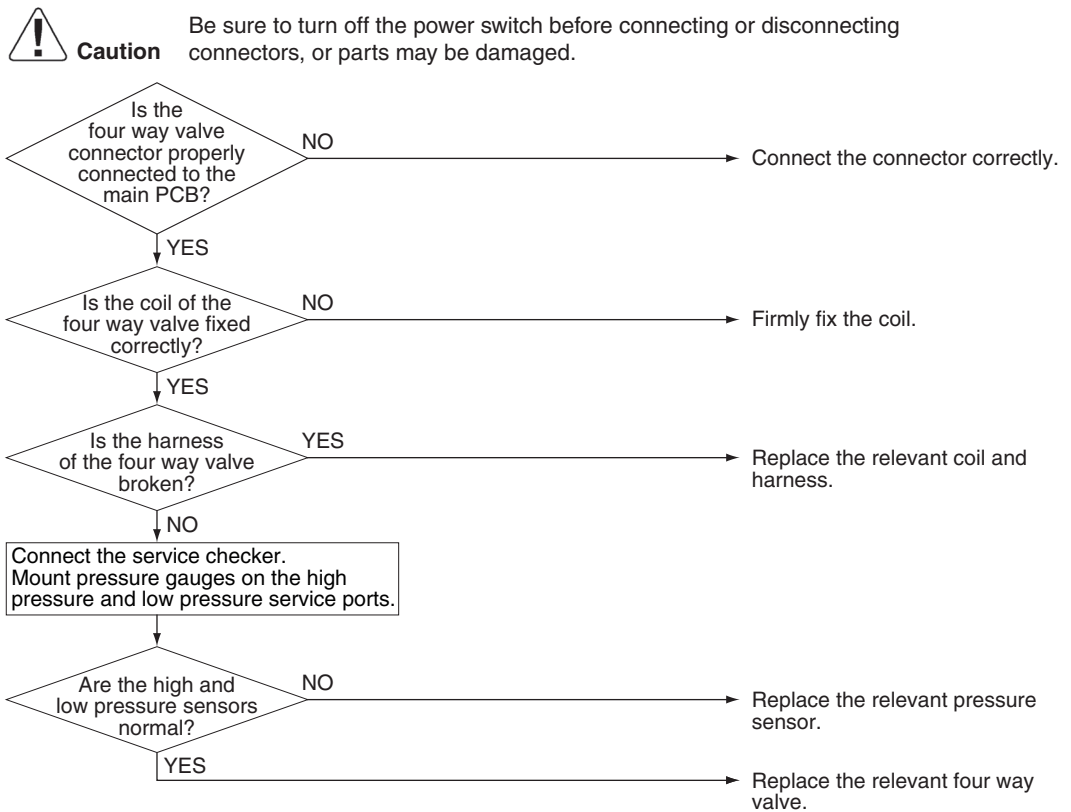

## 3.43 Four Way Valve Abnormality (Not Switching)

---

**Applicable Models** All outdoor unit models

---

**Error Code** **EA**  
Sub code: 14-21

---

**Method of Error Detection** Detect the non-switching of the four way valve according to temperature and pressure.

---

**Error Decision Conditions**

- When the evaporator is in a condenser-like refrigerant state
- When the condenser is in an evaporator-like refrigerant state.

---

**Supposed Causes**

- Defective high pressure sensor
- Defective low pressure sensor
- Defective outdoor air thermistor
- Defective heat exchanger gas pipe thermistor
- Defective heat exchanger liquid pipe thermistor
- Defective suction pipe thermistor
- Defective compressor suction thermistor
- Defective indoor unit thermistor
- Defective coil or harness of four way valve
- Defective four way valve

Troubleshooting



**Caution** Be sure to turn off the power switch before connecting or disconnecting connectors, or parts may be damaged.

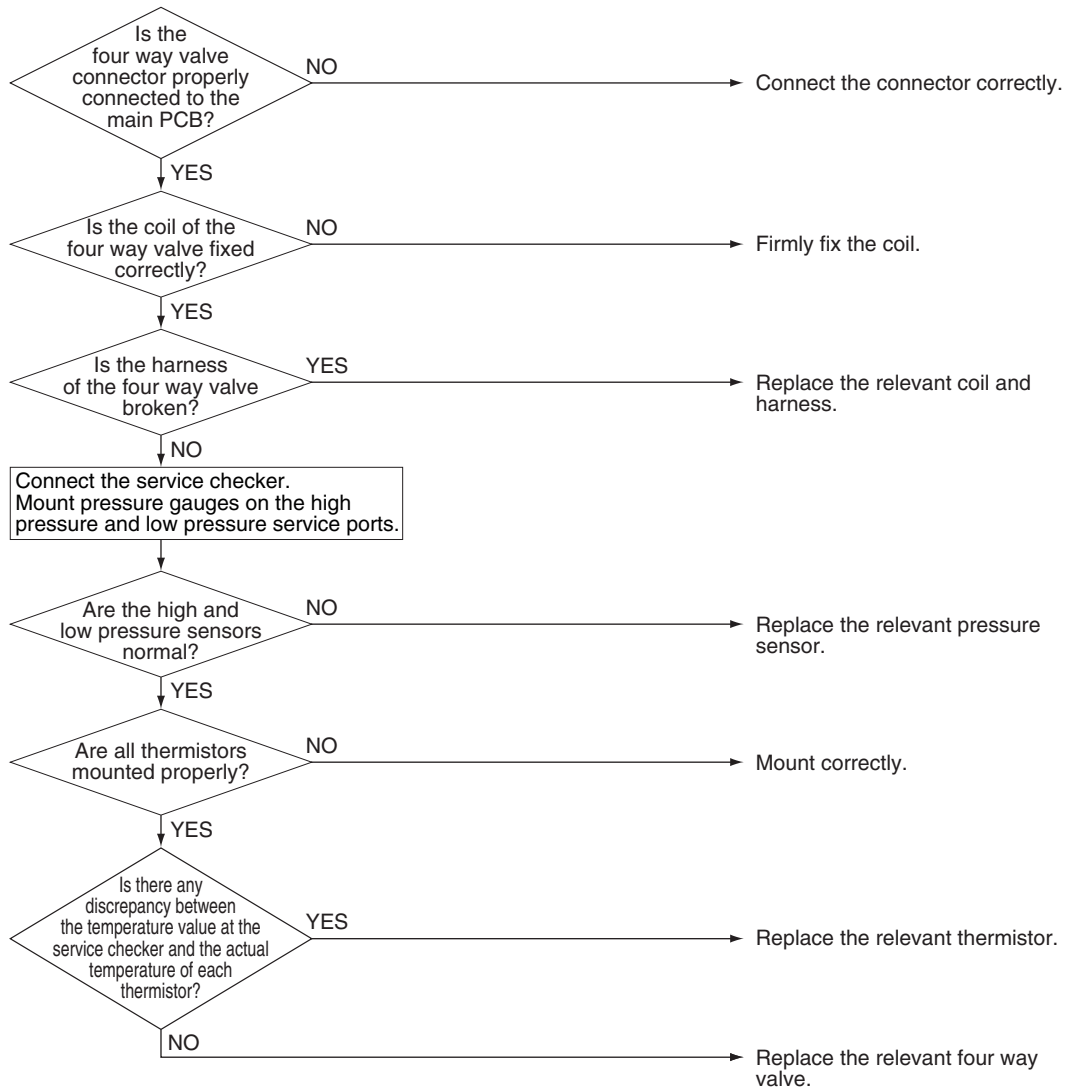



## 3.44 Opposite Air Conditioning Alarm

<b>Applicable Models</b>	All outdoor unit models
<b>Error Code</b>	<b>EA</b> Sub code: 26
<b>Method of Error Detection</b>	Detects by the temperature of each thermistor of the indoor unit.
<b>Error Decision Conditions</b>	<ul style="list-style-type: none"> <li>■ When the flow direction of the refrigerant is heating during cooling operation in the indoor unit.</li> <li>■ When the flow direction of the refrigerant is cooling during heating operation in the indoor unit.</li> </ul>
<b>Supposed Causes</b>	Wrong wiring between Branch selector unit and indoor unit
<b>Troubleshooting</b>	<div style="text-align: center;">  <p><b>Caution</b> Be sure to turn off the power switch before connecting or disconnecting connectors, or parts may be damaged.</p> </div> <div style="border: 1px solid black; padding: 5px; width: fit-content; margin: 10px auto;"> <p>Conduct the wrong wiring automatic detection operation. (Refer to setting 2-20)</p> </div> <div style="text-align: right; margin-top: 10px;"> <p>→ Check the wiring of the indoor unit where the <b>UF</b> abnormality has occurred.</p> </div>



### Reference

For details on field setting 2-20, refer to page 255.

## 3.45 Discharge Pipe Temperature Abnormality

---

<b>Applicable Models</b>	All outdoor unit models
<b>Error Code</b>	<b>F3</b>
<b>Method of Error Detection</b>	Detect according to temperature detected with the discharge pipe or compressor body thermistor.
<b>Error Decision Conditions</b>	<ul style="list-style-type: none"><li>■ When discharge pipe temperature becomes abnormally high (i.e., 135°C (275°F) or more)</li><li>■ When discharge pipe temperature sharply rises (remains at 120°C (248°F) or more for a period of consecutive 10 minutes)</li><li>■ When compressor surface temperature becomes abnormally high (i.e., 120°C (248°F) or more)</li><li>■ When compressor surface temperature sharply rises (remains at 115°C (239°F) or more for a period of consecutive 10 minutes)</li></ul>
<b>Supposed Causes</b>	<ul style="list-style-type: none"><li>■ Abnormal discharge pipe temperature</li><li>■ Defective discharge pipe thermistor</li><li>■ Abnormal compressor surface temperature</li><li>■ Defective compressor body thermistor</li><li>■ Defective outdoor unit main PCB</li></ul>

Troubleshooting



**Caution** Be sure to turn off the power switch before connecting or disconnecting connectors, or parts may be damaged.

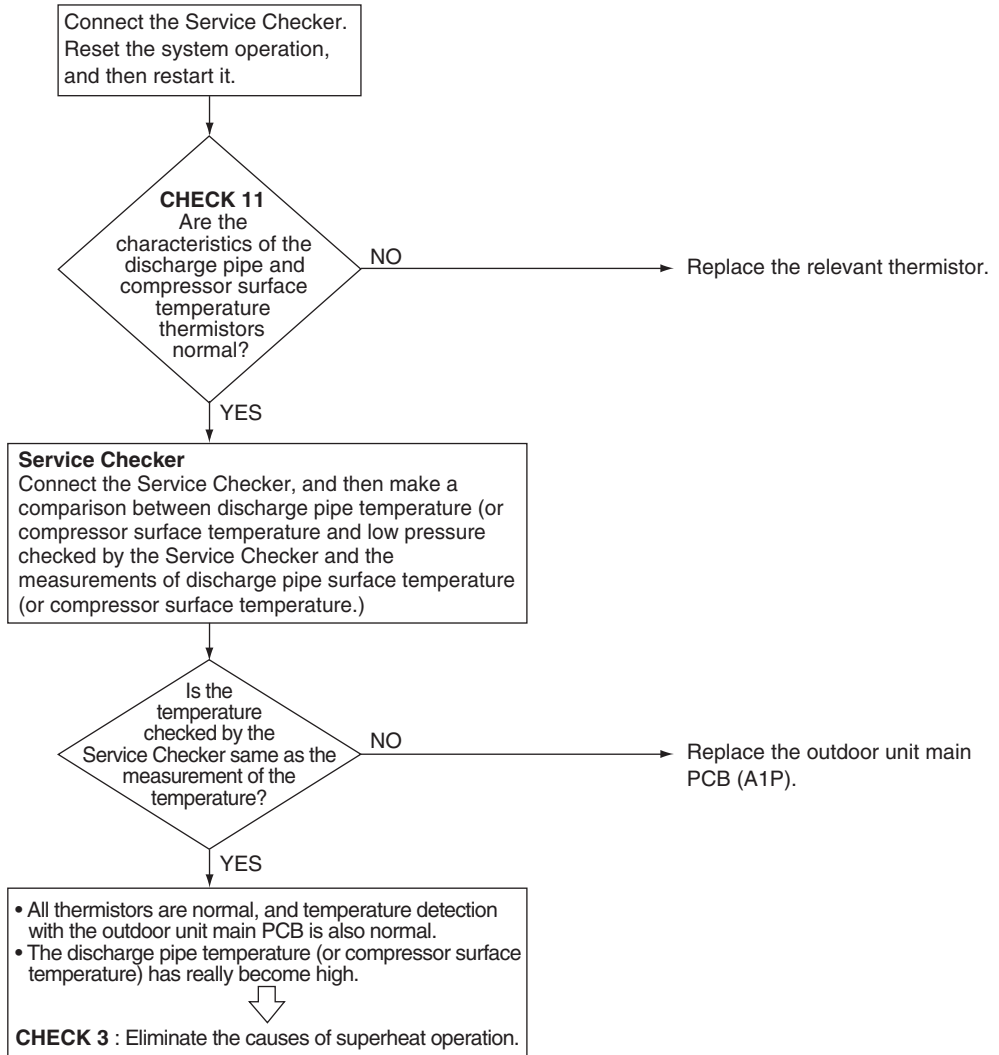

**Reference** CHECK 3 Refer to page 452.



**Reference** CHECK 11 Refer to page 459.

## 3.46 Wet Alarm

---

**Applicable Models** All outdoor unit models

---

**Error Code** **F4**

---

**Method of Error Detection** In cooling operation, detect the condition under which liquid refrigerant returns to the compressor, according to the temperature and pressure of each part.

---

**Error Decision Conditions** When the following wet state continues for a period of 90 minutes, an alert is issued.  
An error is defined for 120 minutes.

- Wet state in outdoor units

When the following wet state continues for a period of 45 minutes, an alert is issued.

- Wet state in some of indoor units

---

**Supposed Causes**

- Defective suction pipe thermistor
- Defective compressor suction thermistor
- Defective discharge pipe thermistor
- Defective high pressure sensor
- Defective indoor unit electronic expansion valve
- Dirty air filter

Troubleshooting



**Caution** Be sure to turn off the power switch before connecting or disconnecting connectors, or parts may be damaged.

Connect the Service Checker.  
Mount a pressure gauge on the high pressure service port.  
Reset the operation, and then restart the operation.

Are the characteristics of the suction pipe thermistor and the compressor suction thermistor normal?

NO

Replace the relevant thermistor.

YES

Are the discharge pipe thermistor characteristics normal?

NO

Replace the discharge pipe thermistor.

YES

Are the high pressure sensor characteristics normal?

NO

Replace the high pressure sensor (S1NPH).

YES

**Service Checker**  
Use the Service Checker to find indoor units operating under the following conditions:  
& [ Gas pipe temperature – Liquid pipe temperature < 2.5°C (4.5°F)  
[ Electronic expansion valve opening < 300 pulses

Stop the relevant indoor units while the system is in cooling operation, and then check for the liquid pipe temperature of these indoor units after the system is stabilized.

The liquid pipe temperature is low (equivalent to the evaporating temperature).

YES

Replace the indoor unit electronic expansion valve.

NO

Clean the air filters of the indoor units.

### 3.47 Refrigerant Overcharged

<b>Applicable Models</b>	All outdoor unit models
<b>Error Code</b>	<b>F6</b>
<b>Method of Error Detection</b>	Detect overcharged refrigerant according to outdoor air temperature, heat exchanger deicer temperature, and liquid pipe temperature during check operation.
<b>Error Decision Conditions</b>	When the amount of refrigerant, which is calculated using outdoor air temperature, heat exchanger deicer temperature, and liquid pipe temperature during check operation, exceeds the regular charge amount by 30% or more (If refrigerant is charged slightly over the regular charge amount, <b>F6</b> may be displayed on the remote controller.)
<b>Supposed Causes</b>	<ul style="list-style-type: none"> <li>■ Refrigerant overcharged</li> <li>■ Disconnection of outdoor air thermistor</li> <li>■ Disconnection of heat exchanger deicer thermistor</li> <li>■ Disconnection of liquid pipe temperature thermistor</li> </ul>

**Troubleshooting**

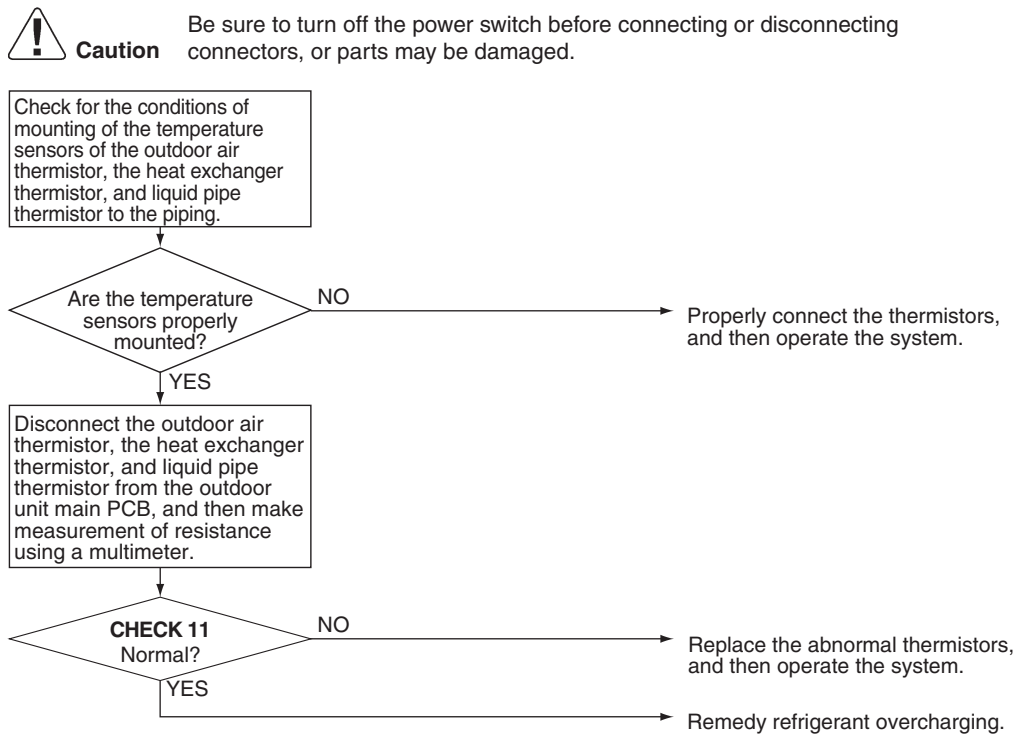

Reference

**CHECK 11** Refer to page 459.

## 3.48 Branch Selector Unit Electronic Expansion Valve Abnormality

<b>Applicable Models</b>	Branch Selector unit
<b>Error Code</b>	<b>F9</b>
<b>Method of Error Detection</b>	The error is detected by whether or not all coils of the electronic expansion valve have continuity.
<b>Error Decision Conditions</b>	The power supply turns ON, but there is no currents pass through the common (COM[+]).
<b>Supposed Causes</b>	<ul style="list-style-type: none"> <li>■ Disconnection of the electronic expansion valve connector</li> <li>■ Defective electronic expansion valve coil</li> <li>■ Defective PCB of Branch Selector unit</li> </ul>

### Troubleshooting

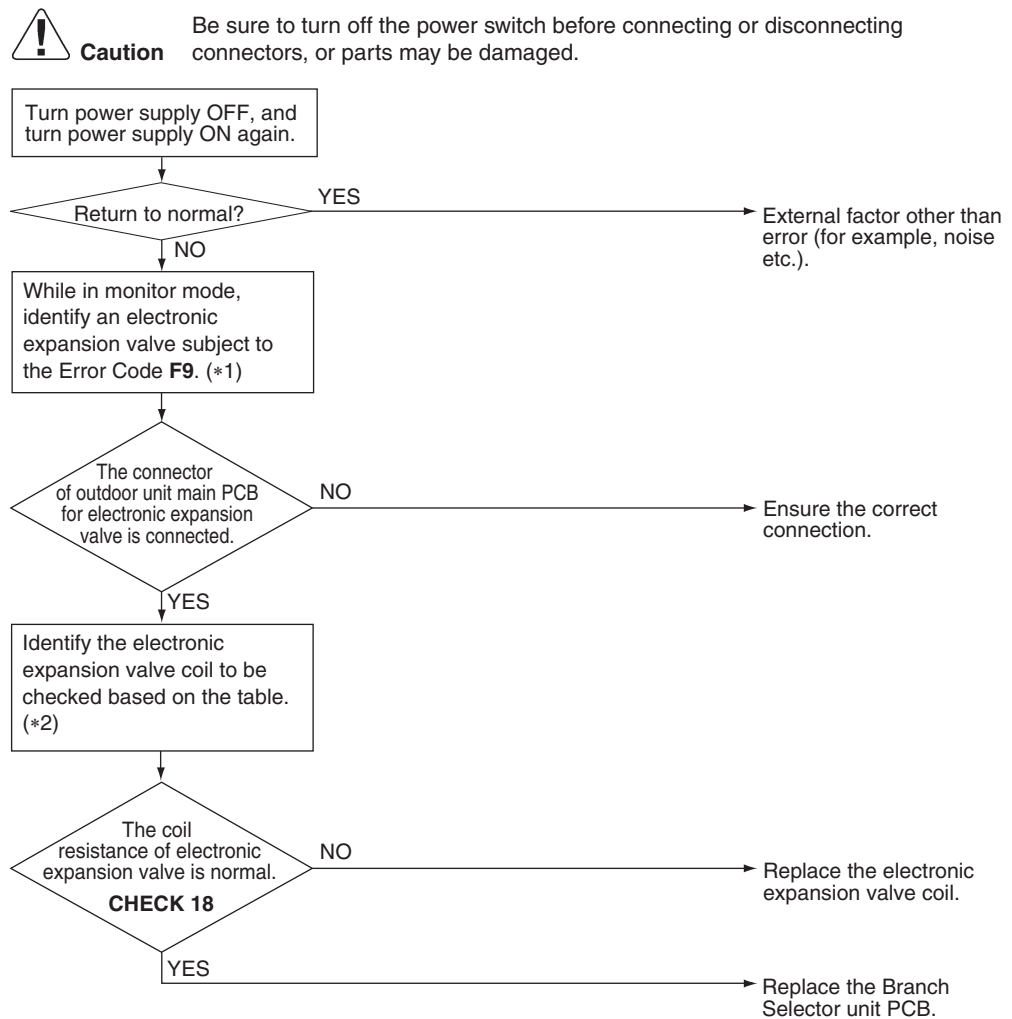



**Note(s)**

\*1. Use the sub code to identify the electronic expansion valve subject to error code **F9**.

Electronic expansion valve	Sub code
Electronic expansion valve (EVH)	01
Electronic expansion valve (EVL)	02
Electronic expansion valve (EVSC)	05

\*2. Use the sub code to identify the electronic expansion valve for checking coil resistance subject to error code **F9**.

Model	Electronic expansion valve to be checked	Sub code
BSQ-T BSQ-TA BS-Q54T	All electronic expansion valves	Any code
BS-Q54TA BSF-Q54T	All the electronic expansion valves of branch selector unit PCBs that are connected to indoor units issuing error code <b>F9</b>	01
	Electronic expansion valve (EVL)	02
	Electronic expansion valve (EVSC)	05



**Reference**

**CHECK 18** Refer to page 470.



## 3.49 Thermistor Abnormality

<b>Applicable Models</b>	All outdoor unit models
<b>Error Code</b>	<b>H1, H9, J3, J5, J6, J7, J8, J9</b>
<b>Method of Error Detection</b>	Detect according to temperature detected with individual thermistors.
<b>Error Decision Conditions</b>	The system is in operation and the thermistor causes wiring disconnection or short circuit in it.
<b>Supposed Causes</b>	<ul style="list-style-type: none"> <li>■ Defective connection of thermistor</li> <li>■ Defective thermistor</li> <li>■ Defective outdoor unit PCB</li> </ul>

### Troubleshooting

**Caution**

Be sure to turn off the power switch before connecting or disconnecting connectors, or parts may be damaged.

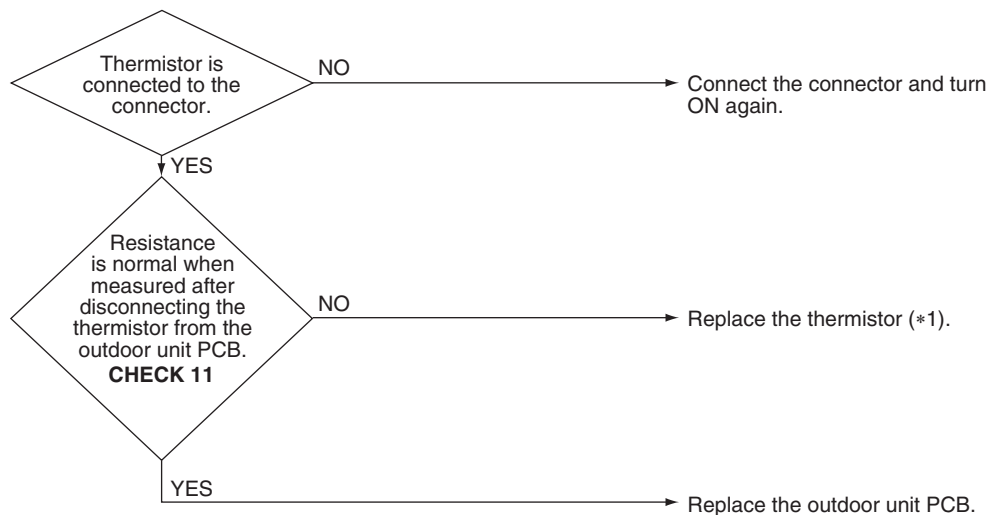
**Note(s)**

\*1. Check the error code and sub code, and replace the corresponding thermistor.



**Reference**

**CHECK 11** Refer to page 459.

### 3.50 Harness Abnormality (between Outdoor Unit Main PCB and Inverter PCB)

<b>Applicable Models</b>	All outdoor unit models
<b>Error Code</b>	<b>H3</b>
<b>Method of Error Detection</b>	Check for the transmission conditions of the harnesses between the PCBs using microcomputer.
<b>Error Decision Conditions</b>	Normal transmission between the PCBs is disabled while the compressor is not running.
<b>Supposed Causes</b>	<ul style="list-style-type: none"> <li>■ Defective connection of jumpers between PCB</li> <li>■ Defective outdoor unit main PCB (A1P)</li> <li>■ Defective inverter PCB</li> </ul>

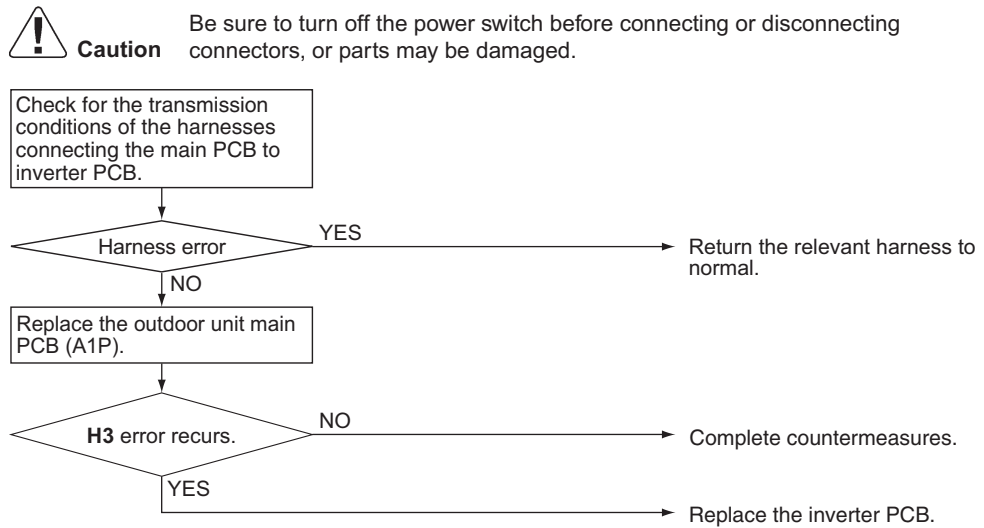
**Troubleshooting**



## 3.51 Outdoor Fan PCB Abnormality

**Applicable Models** All outdoor unit models

**Error Code** **H7**

**Method of Error Detection** Detect with current sensor value.

**Error Decision Conditions** When the current sensor shows abnormality.

**Supposed Causes** Defective fan PCB

### Troubleshooting



**Caution**

Be sure to turn off the power switch before connecting or disconnecting connectors, or parts may be damaged.

Check for fan PCB applicable to the error code **H7** while in monitor mode.  
 H7-21/23: Fan PCB (M1F) Master / Sub  
 H7-22/24: Fan PCB (M2F) Master / Sub

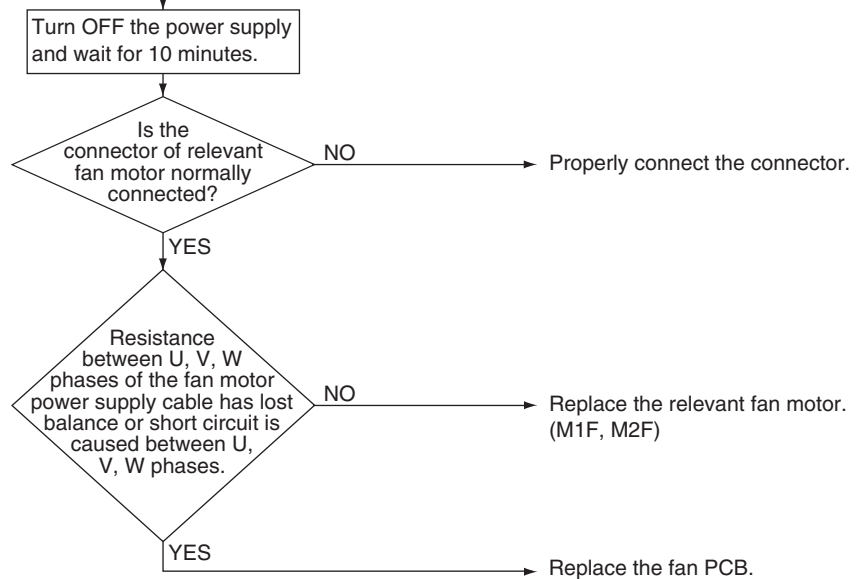

### 3.52 High Pressure Sensor Abnormality

<b>Applicable Models</b>	All outdoor unit models
<b>Error Code</b>	<b>JA</b>
<b>Method of Error Detection</b>	Detects according to temperature detected with the high pressure sensor.
<b>Error Decision Conditions</b>	The high pressure sensor is short circuit or open circuit. (Pressure range: 0-4.3 MPa (0-624 psi))
<b>Supposed Causes</b>	<ul style="list-style-type: none"> <li>■ Defective high pressure sensor</li> <li>■ Connection of low pressure sensor in mistake for high pressure sensor</li> <li>■ Defective outdoor unit main PCB</li> <li>■ Defective connection of high pressure sensor</li> </ul>

**Troubleshooting**

 **Caution** Be sure to turn off the power switch before connecting or disconnecting connectors, or parts may be damaged.

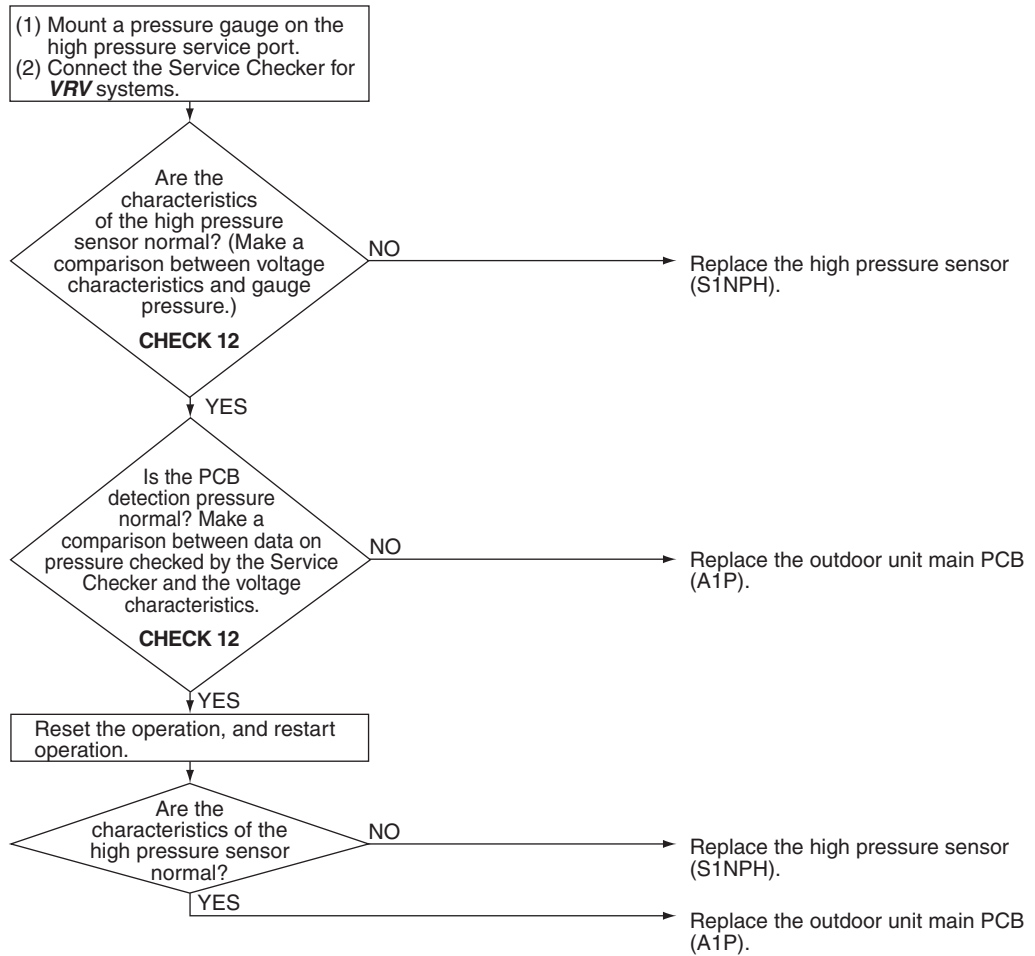

**Reference** CHECK 12 Refer to page 463.

## 3.53 Low Pressure Sensor Abnormality

<b>Applicable Models</b>	All outdoor unit models
<b>Error Code</b>	<b>JC</b>
<b>Method of Error Detection</b>	Detect according to temperature detected with the low pressure sensor.
<b>Error Decision Conditions</b>	The low pressure sensor is short circuit or open circuit. (Pressure range: 0-1.7 MPa (0-247 psi))
<b>Supposed Causes</b>	<ul style="list-style-type: none"> <li>■ Defective low pressure sensor</li> <li>■ Connection of high pressure sensor in mistake for low pressure sensor</li> <li>■ Defective outdoor unit main PCB</li> <li>■ Defective connection of low pressure sensor</li> </ul>

### Troubleshooting

**Caution**

Be sure to turn off the power switch before connecting or disconnecting connectors, or parts may be damaged.

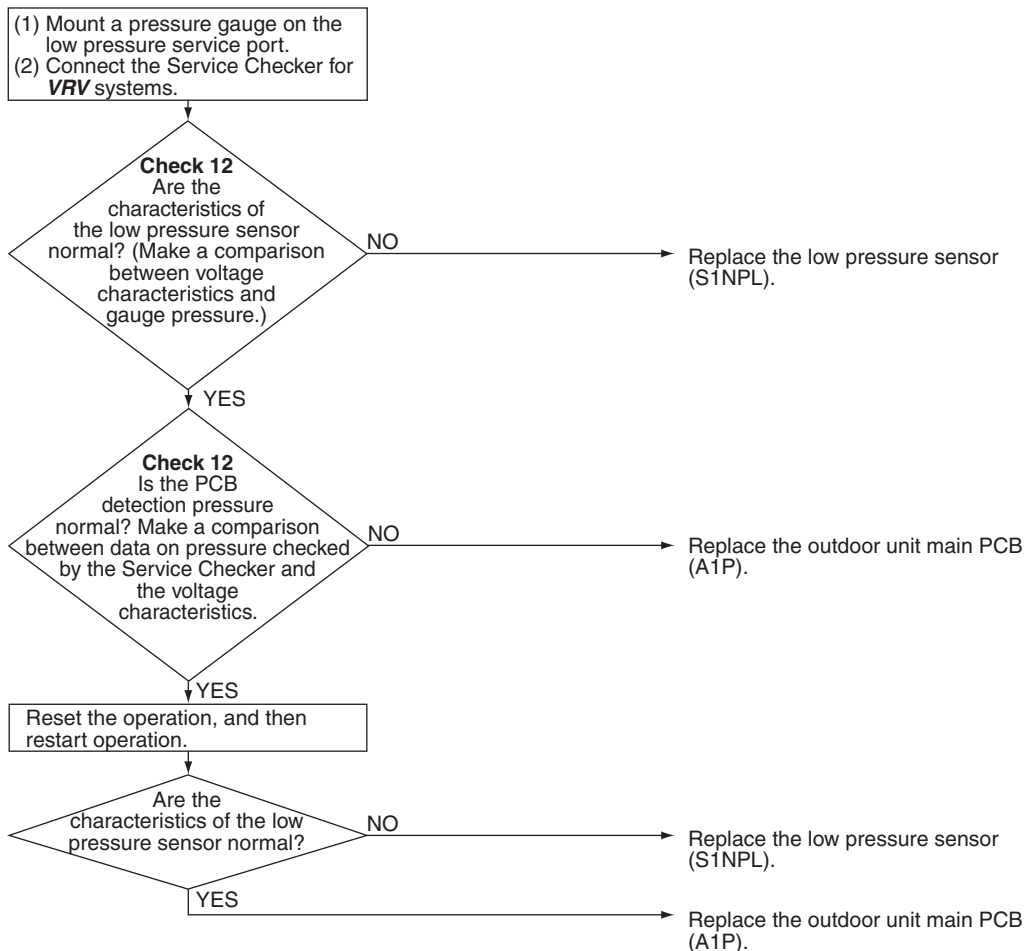
**Reference**

**CHECK 12** Refer to page 463.

## 3.54 Inverter PCB Abnormality

---

**Applicable Models** All outdoor unit models

---

**Error Code** **L1**

---

**Method of Error Detection**

- Detect current value during the output of waveform before compressor startup
- Detect current value with the current sensor during synchronous operation for startup

---

**Error Decision Conditions**

- When the overcurrent flows during the output of waveform
- When the current sensor error during synchronous operation
- When IPM error occurs

---

**Supposed Causes**

- Inverter PCB
  - IPM failure
  - Current sensor failure
  - Drive circuit failure

Troubleshooting



**Caution** Be sure to turn off the power switch before connecting or disconnecting connectors, or parts may be damaged.

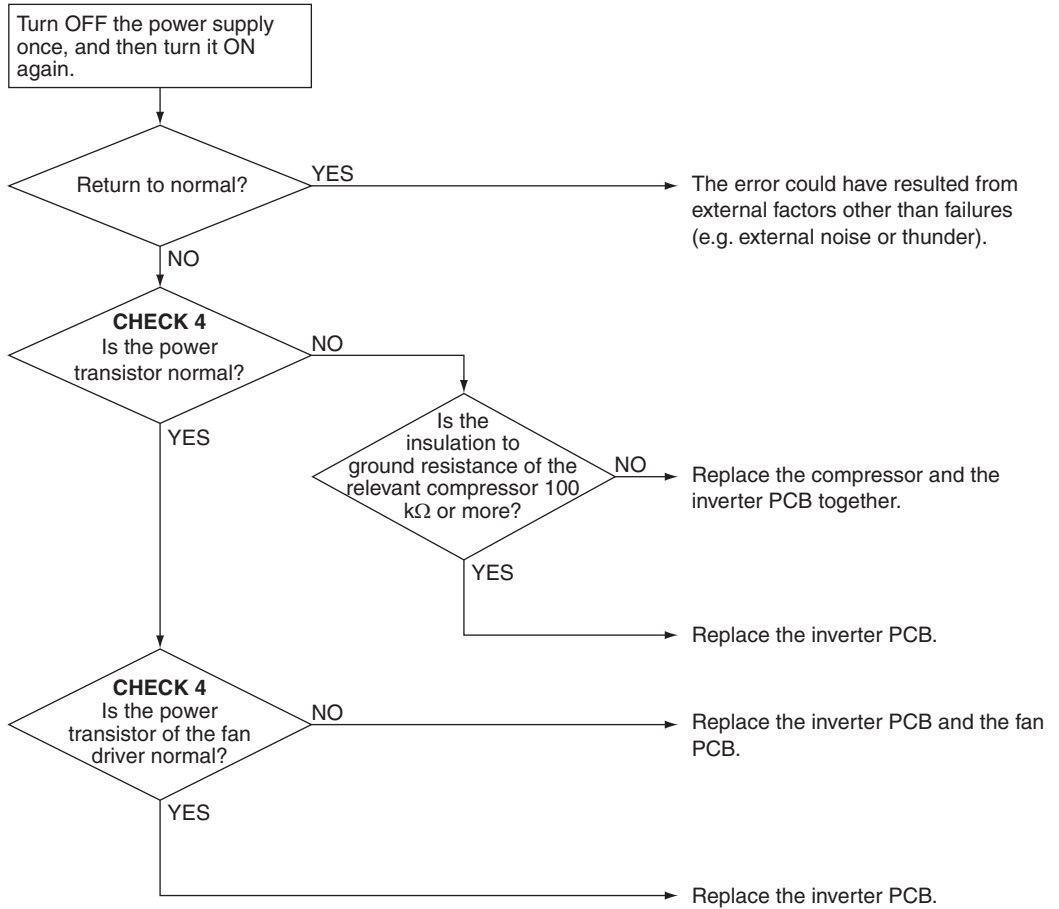

**Reference** **CHECK 4** Refer to page 454.

### 3.55 Momentary Power Failure during Test Operation

<b>Applicable Models</b>	All outdoor unit models
<b>Error Code</b>	<b>L2</b>
<b>Method of Error Detection</b>	Momentary power failure is detected by the PCB.
<b>Error Decision Conditions</b>	Judgment is made by AC power frequency detection circuit on the outdoor unit main PCB.
<b>Supposed Causes</b>	<ul style="list-style-type: none"> <li>■ Defective wiring</li> <li>■ Defective outdoor unit main PCB</li> </ul>

**Troubleshooting**



**Caution**

Be sure to turn off the power switch before connecting or disconnecting connectors, or parts may be damaged.

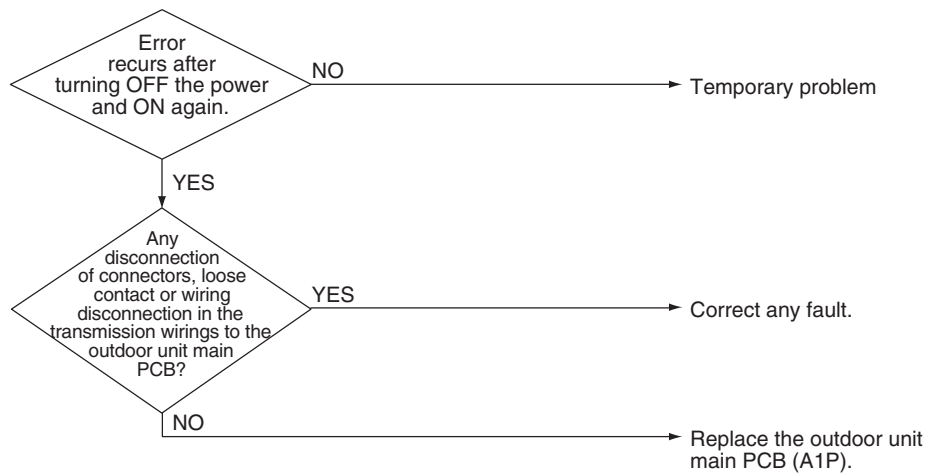



## 3.56 Inverter Radiation Fin Temperature Rise Abnormality

### 3.56.1 Inverter Radiation Fin Temperature Rise Abnormality (Inverter PCB)

---

**Applicable Models** All outdoor unit models

---

**Error Code** **L4**  
Sub code: 01, 02, 09, 10

---

**Method of Error Detection** Detect temperature of power module of the inverter PCB.

---

**Error Decision Conditions** Thermistor located inside the power module of the inverter PCB for compressor and fan motor.  
Cooling tube plate poor heat-exchange.

---

**Supposed Causes**

- Cooling tube plate not fixed with screws
- **U0** error
- Defective inverter PCB
- High outdoor air temperature
- Incorrect power supply voltage
- Defective connection of connectors

Troubleshooting



**Caution** Be sure to turn off the power switch before connecting or disconnecting connectors, or parts may be damaged.

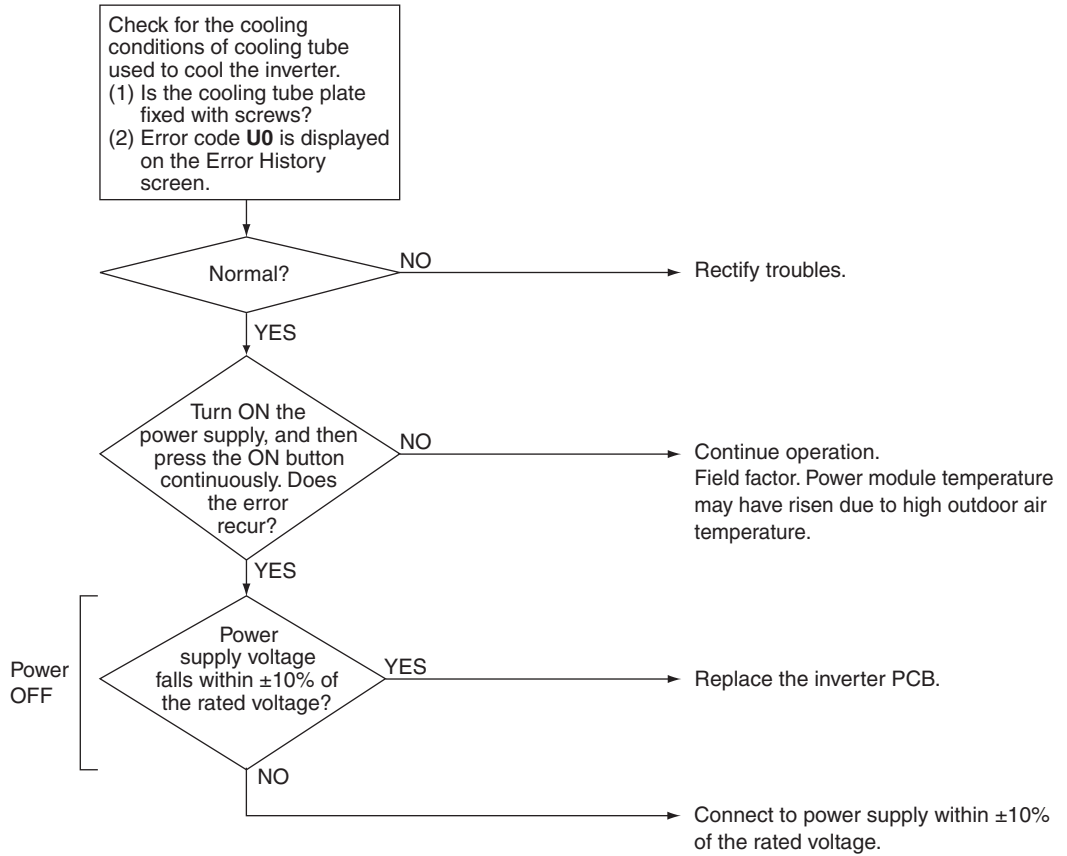

### 3.56.2 Inverter Radiation Fin Temperature Rise Abnormality (Fan PCB)

<b>Applicable Models</b>	All outdoor unit models
<b>Error Code</b>	<b>L4</b> Sub code: 06, 07, 18, 19
<b>Method of Error Detection</b>	Fan PCB radiation fin temperature is detected by the thermistor located inside the fan PCB circuit.
<b>Error Decision Conditions</b>	Detected temperature exceeds a certain level.
<b>Supposed Causes</b>	<ul style="list-style-type: none"> <li>■ Radiation fin plate not fixed with screws</li> <li>■ <b>U0</b> error</li> <li>■ Defective fan PCB</li> <li>■ High outdoor air temperature</li> </ul>

#### Troubleshooting

**Caution**

Be sure to turn off the power switch before connecting or disconnecting connectors, or parts may be damaged.

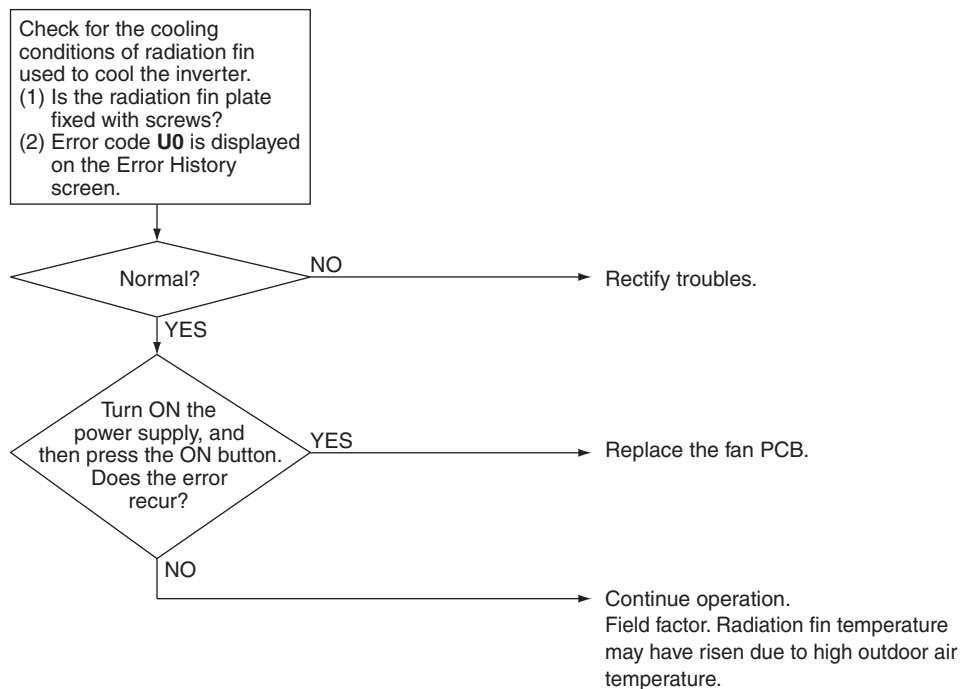

### 3.57 Compressor Instantaneous Overcurrent

**Applicable Models** All outdoor unit models

**Error Code** **L5**

**Method of Error Detection** Detect current flowing through the power transistor.

**Error Decision Conditions** When overcurrent flows instantaneously through the power transistor.

- Supposed Causes**
- Defective compressor coil (such as wiring disconnection or insulation failure)
  - Compressor startup failure (mechanical lock)
  - Defective inverter PCB

**Troubleshooting**



**Caution**

Be sure to turn off the power switch before connecting or disconnecting connectors, or parts may be damaged.

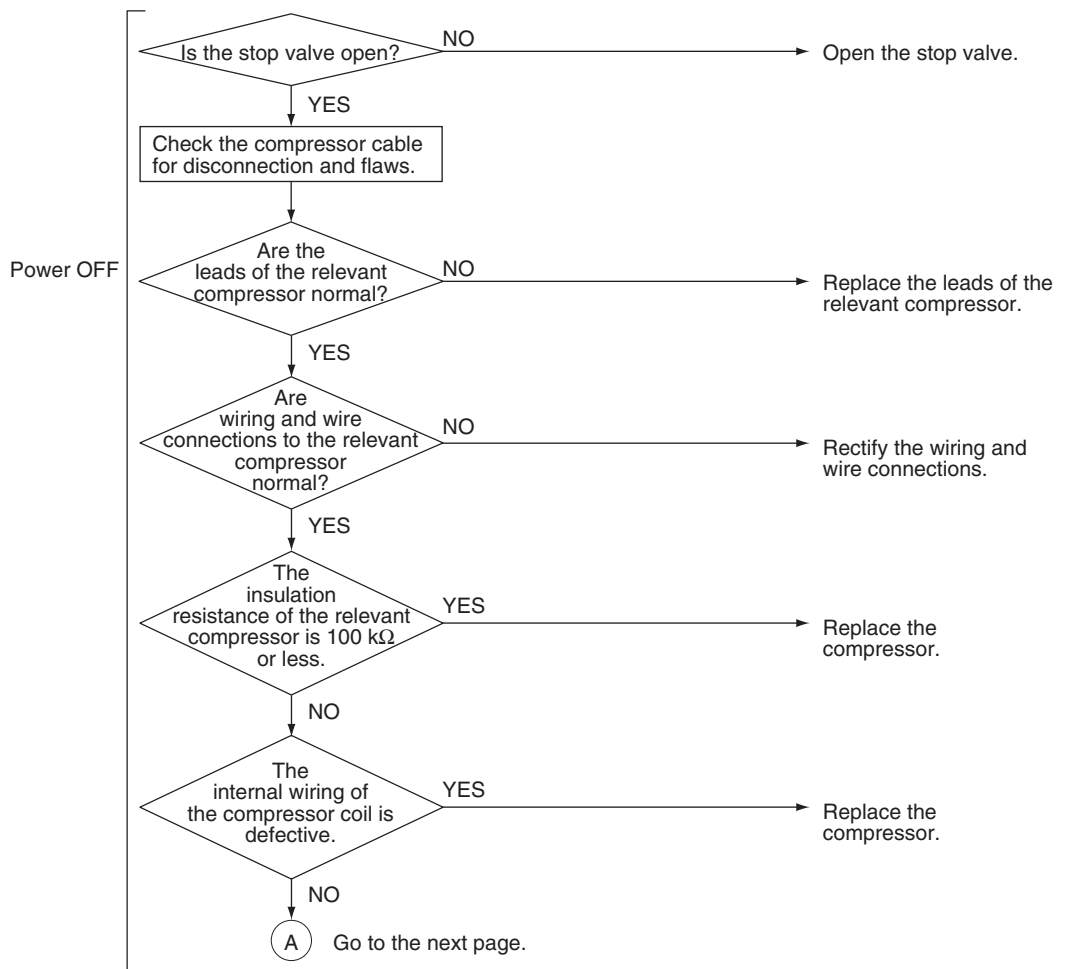

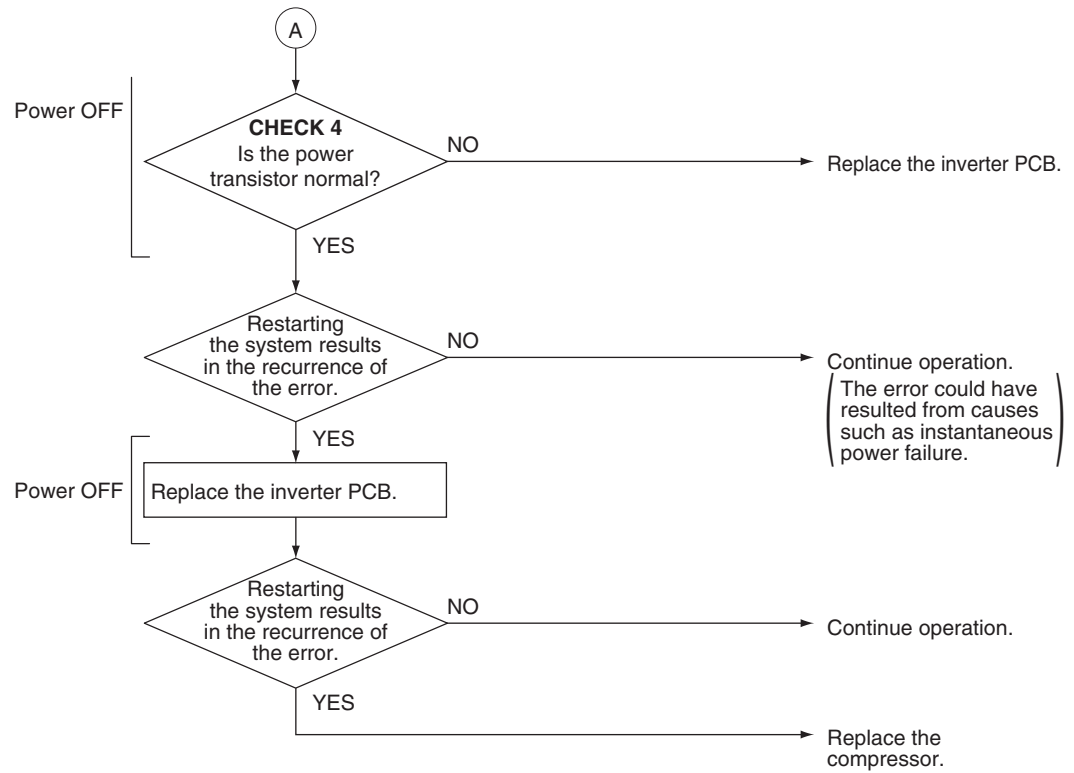

Reference **CHECK 4** Refer to page 454.

### 3.58 Compressor Overcurrent

**Applicable Models** All outdoor unit models

**Error Code** **L8**

**Method of Error Detection** Detect current flowing through the power transistor.

**Error Decision Conditions** When the secondary-side inverter current exceeds a certain value.

- Supposed Causes**
- Compressor overloaded
  - Wiring disconnection in compressor coil
  - Disconnection of compressor wiring
  - Defective inverter PCB
  - Incorrect power supply voltage

**Troubleshooting**



**Caution**

Be sure to turn off the power switch before connecting or disconnecting connectors, or parts may be damaged.

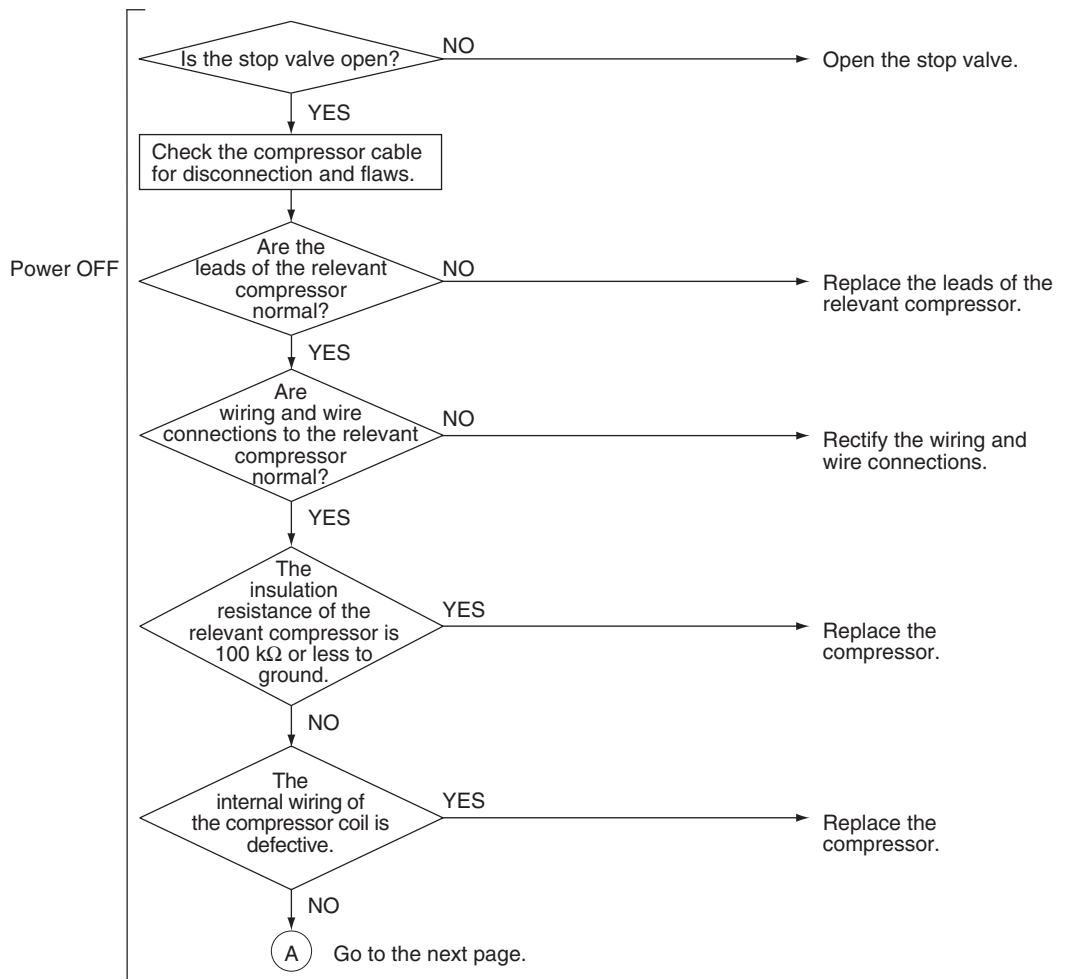

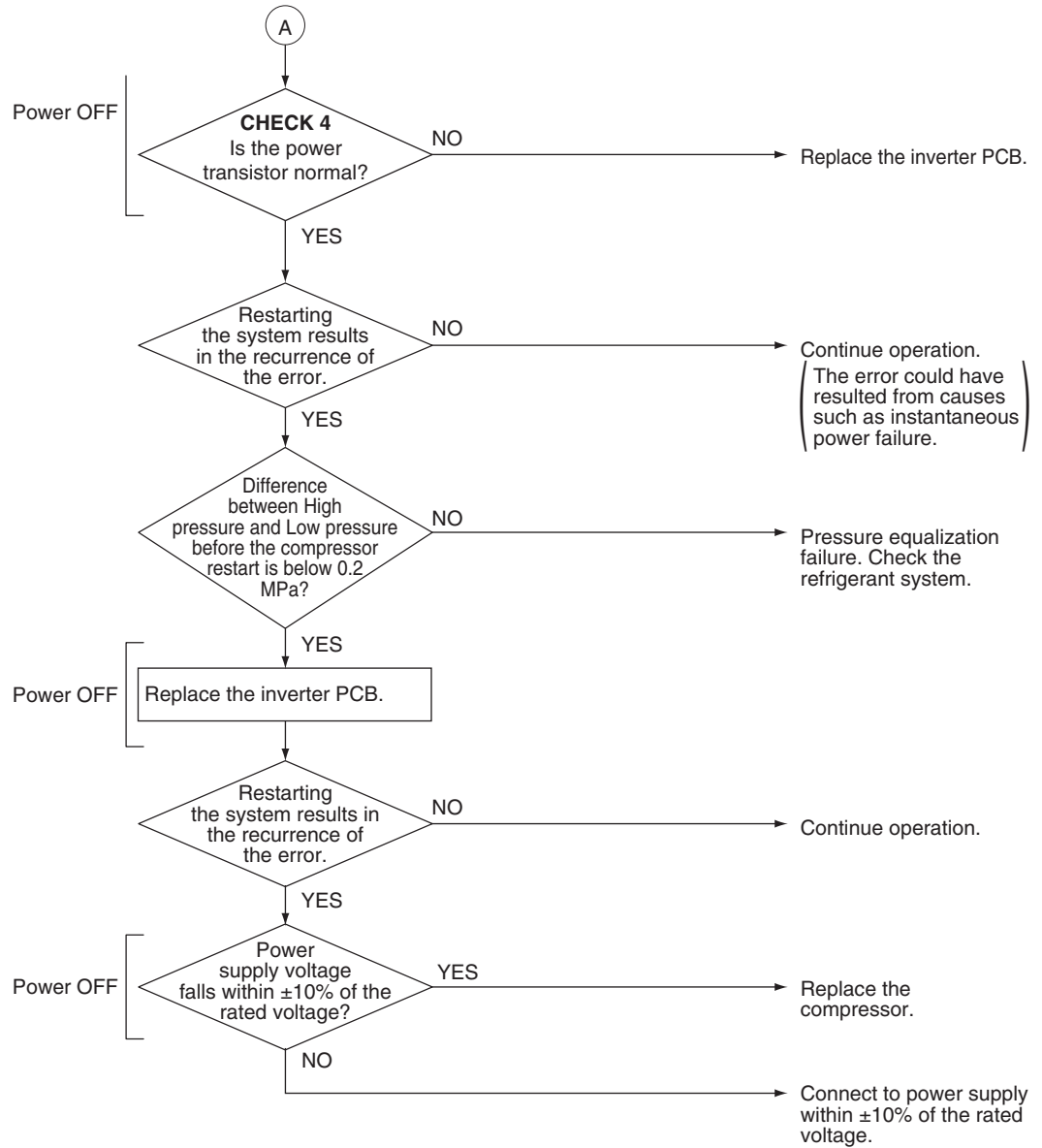

Reference CHECK 4 Refer to page 454.

### 3.59 Compressor Startup Abnormality

<b>Applicable Models</b>	All outdoor unit models
<b>Error Code</b>	<b>L9</b>
<b>Method of Error Detection</b>	Detect error according to the signal waveform of compressor.
<b>Error Decision Conditions</b>	When compressor startup operation has not been completed.
<b>Supposed Causes</b>	<ul style="list-style-type: none"> <li>■ The stop valve is not opened</li> <li>■ Defective compressor</li> <li>■ Error in wire connections to compressor</li> <li>■ Large differential pressure before compressor startup</li> <li>■ Defective inverter PCB</li> </ul>

**Troubleshooting**

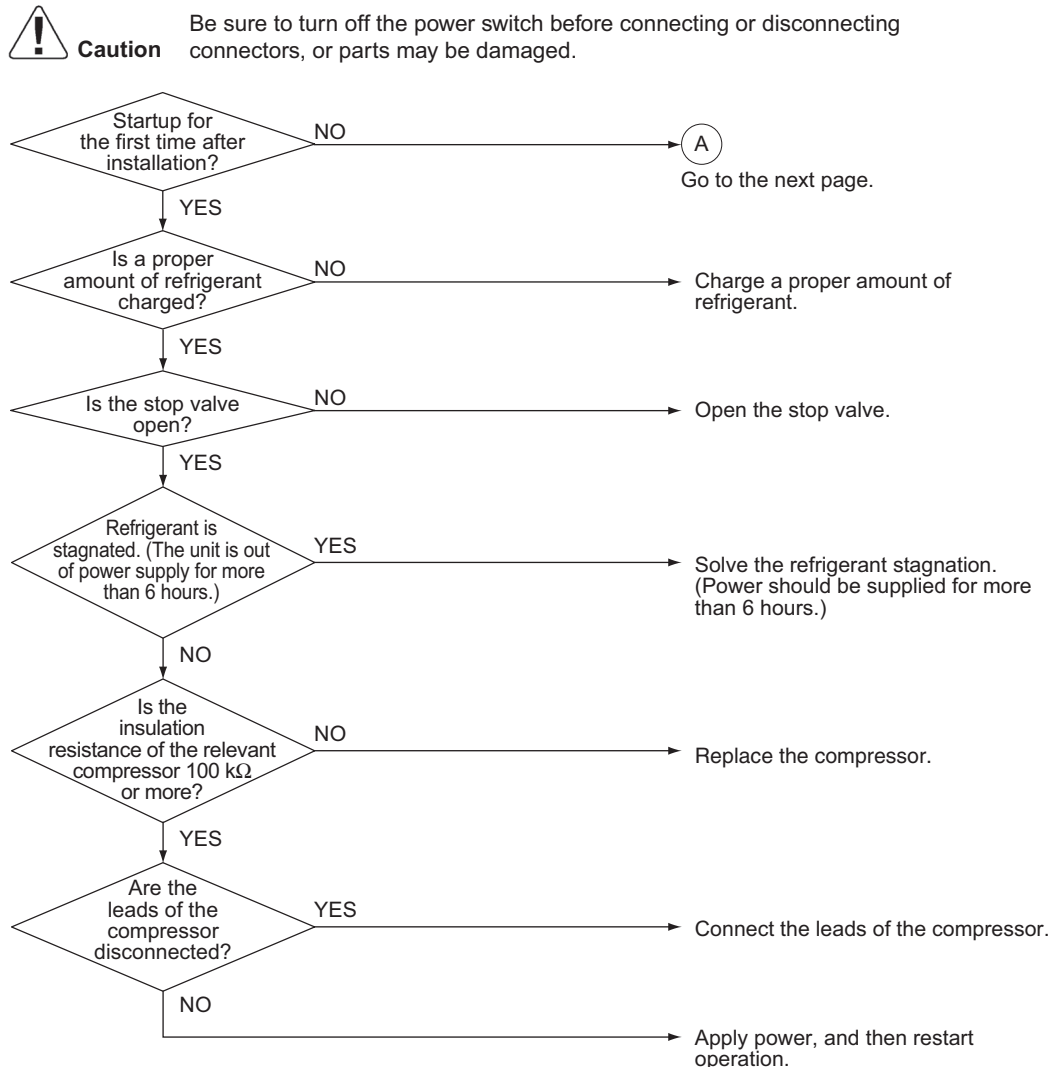



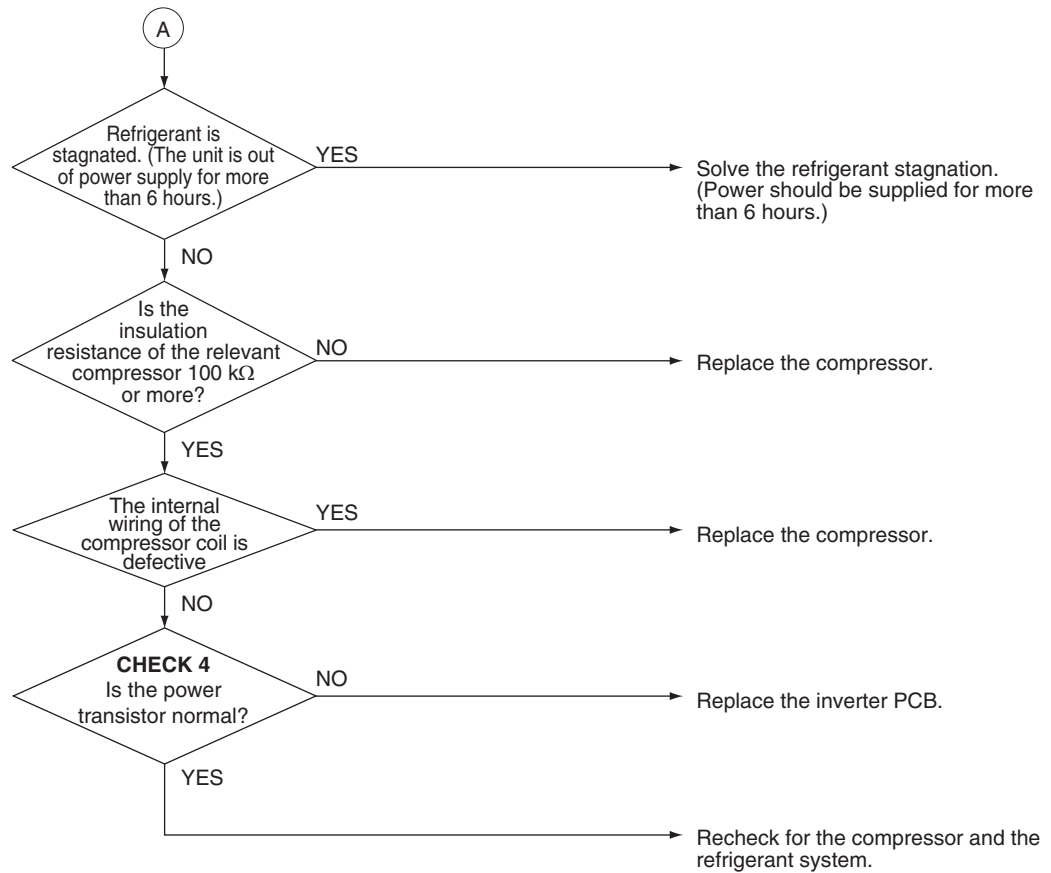

Reference **CHECK 4** Refer to page 454.

## 3.60 Transmission Error between Inverter PCB and Outdoor Unit Main PCB

<b>Applicable Models</b>	All outdoor unit models
<b>Error Code</b>	<b>LC</b>
<b>Method of Error Detection</b>	Check for the transmission conditions between the inverter PCB and the outdoor unit main PCB using a microcomputer.
<b>Error Decision Conditions</b>	When normal transmission is disabled for a given period of time or more.
<b>Supposed Causes</b>	<ul style="list-style-type: none"> <li>■ Defective connection between the inverter PCB and the outdoor unit main PCB</li> <li>■ Defective outdoor unit main PCB (transmission block)</li> <li>■ Defective noise filter, compressor or fan motor</li> <li>■ External factors (e.g. noise)</li> <li>■ Failure of inverter PCB or fan PCB</li> </ul>

### Troubleshooting

 **Caution** Be sure to turn off the power switch before connecting or disconnecting connectors, or parts may be damaged.

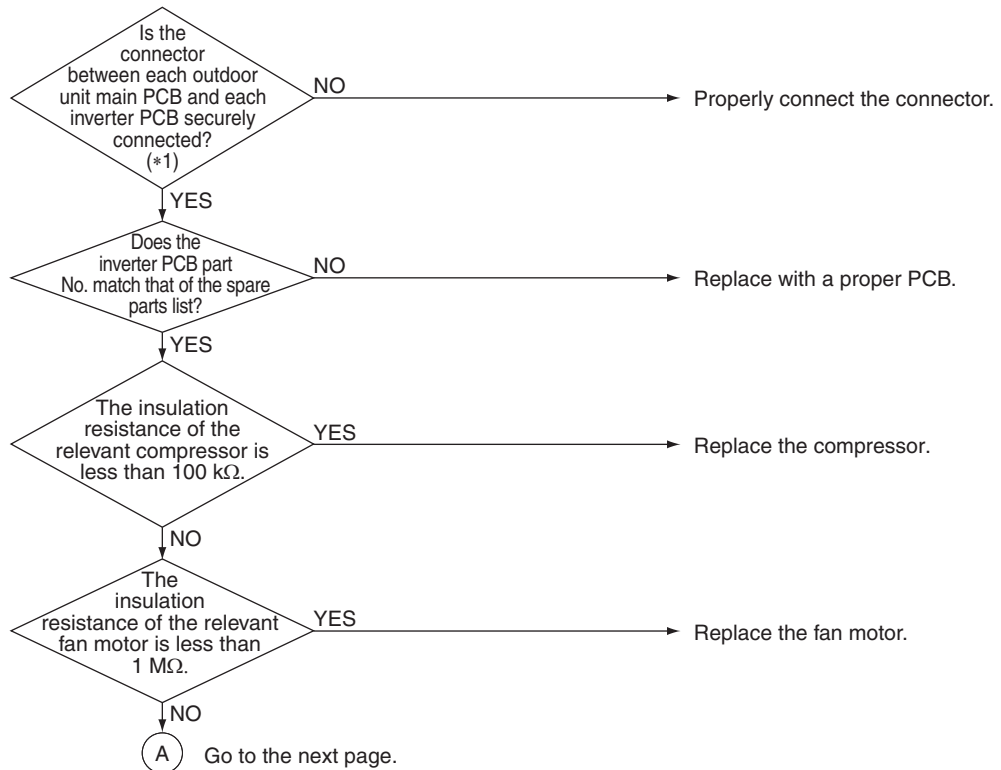

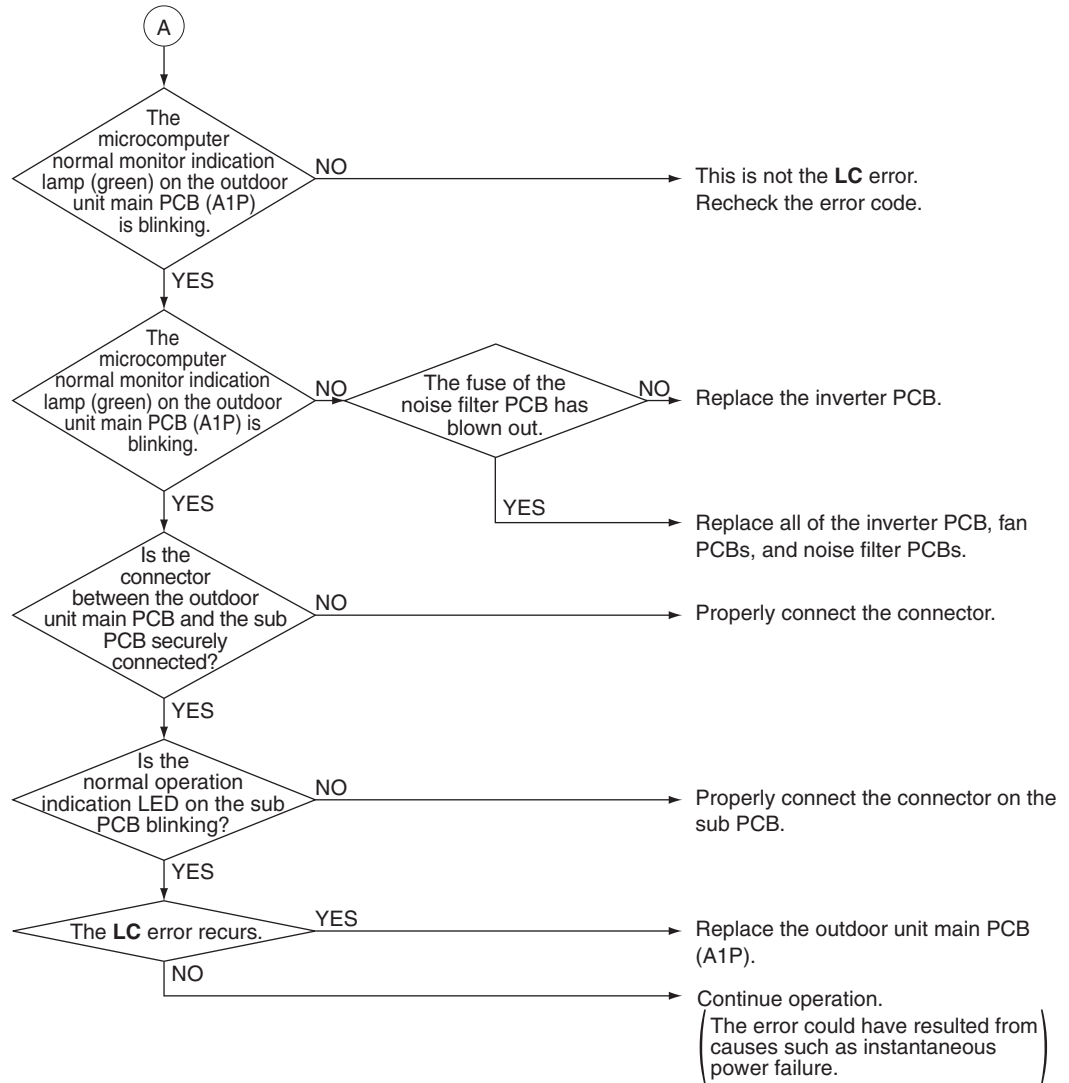
**Note(s)**

\*1. Connect and disconnect the connector once to ensure that it is securely connected.

## 3.61 Power Supply Voltage Imbalance

---

**Applicable Models**

All outdoor unit models

---

**Error Code**

**P1**

---

**Method of Error Detection**

Detect voltage imbalance through inverter PCB.

---

**Error Decision Conditions**

When power supply voltage imbalance exceeds approximately 12 V.

Error is not decided while the unit operation is continued.

**P1** will be displayed by pressing the inspection button.

---

**Supposed Causes**

- Open phase
- Interphase voltage imbalance
- Defective capacitor in the main circuit
- Defective inverter PCB
- Defective magnetic relay
- Defective wiring in the main circuit

## Troubleshooting

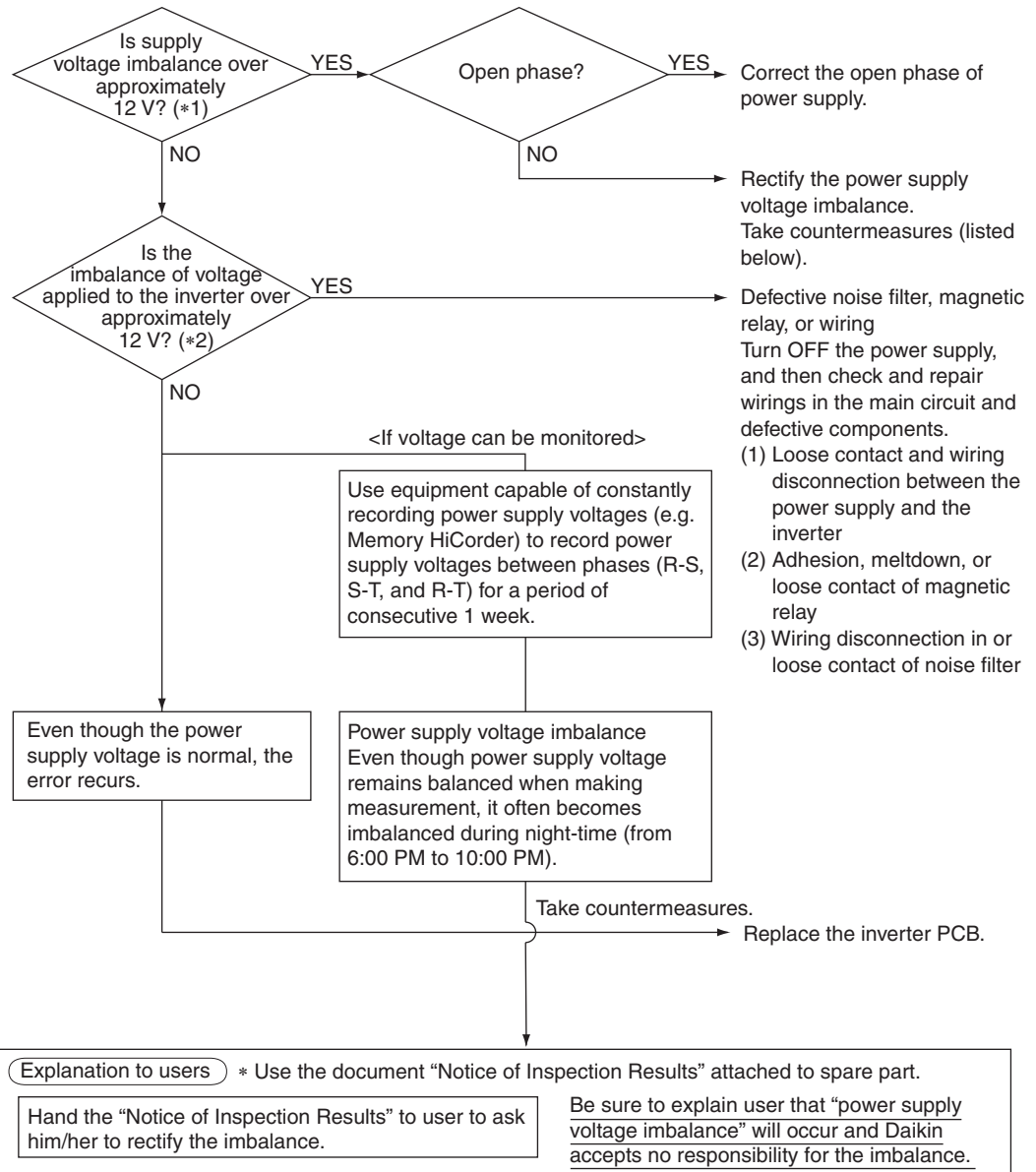

**Caution** Be sure to turn off the power switch before connecting or disconnecting connectors, or parts may be damaged.

**Note(s)**

- \*1. Make measurement of voltage at the power supply terminal block (X1M).
- \*2. Make measurement of voltage at the L1, L2 and L3 terminals of diode module located on the inverter PCB during the compressor is in operation.

## 3.62 Inverter Radiation Fin Temperature Abnormality

### 3.62.1 Inverter Radiation Fin Temperature Abnormality (Inverter PCB)

**Applicable Models** All outdoor unit models

**Error Code** **P4**  
Sub code: 09-13

**Method of Error Detection** Detect the resistance of the following thermistors while the compressor is not running:

- Radiation fin thermistor
- Thermistor located in PCB circuit
- Heat sink thermistor

**Error Decision Conditions** When the resistance of the thermistor comes to a value equivalent to open or short circuit.

Error is not decided while the unit operation is continued.  
**P4** will be displayed by pressing the inspection button.

**Supposed Causes**

- Defective radiation fin temperature thermistor
- Defective inverter PCB
- Defective compressor
- Defective fan motor

#### Troubleshooting



**Caution**

Be sure to turn off the power switch before connecting or disconnecting connectors, or parts may be damaged.

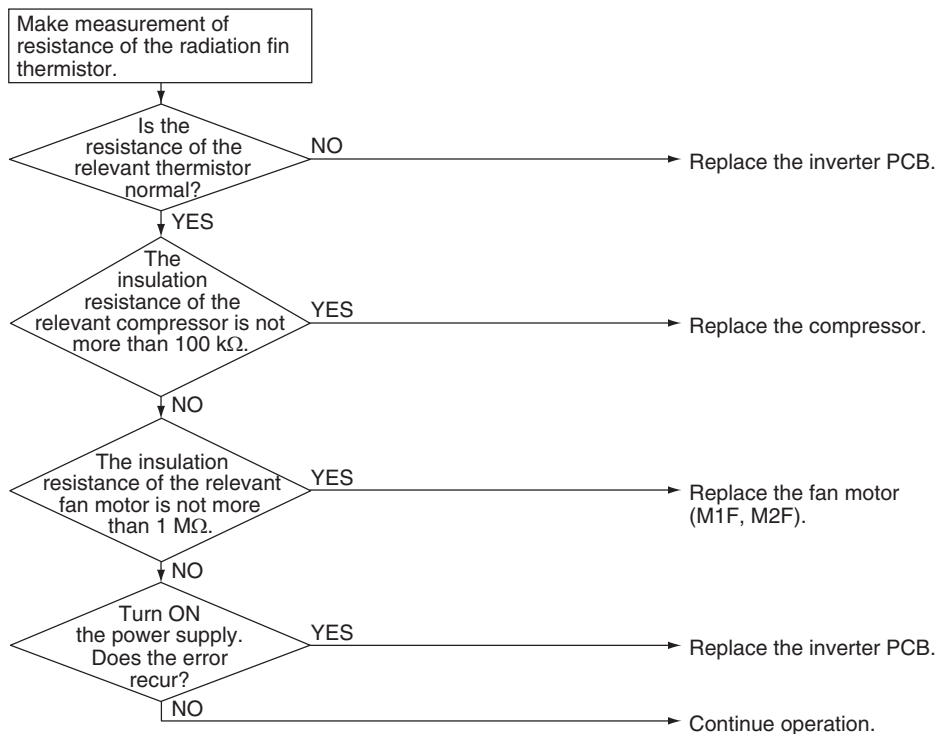

### 3.62.2 Inverter Radiation Fin Temperature Abnormality (Fan PCB)

<b>Applicable Models</b>	All outdoor unit models
<b>Error Code</b>	<b>P4</b> Sub code: 02, 03, 15, 16
<b>Method of Error Detection</b>	Detects the resistance of the thermistor located inside the fan PCB circuit while the fan motor is not in operation.
<b>Error Decision Conditions</b>	The resistance of the thermistor comes to a value equivalent to open or short circuit.
<b>Supposed Causes</b>	<ul style="list-style-type: none"> <li>■ Defective fan PCB</li> <li>■ Defective fan motor</li> </ul>
<b>Troubleshooting</b>	<div style="text-align: center;">  <p><b>Caution</b> Be sure to turn off the power switch before connecting or disconnecting connectors, or parts may be damaged.</p> </div> <div style="border: 1px solid black; padding: 5px; margin: 10px 0;"> <p>Check for fan PCB applicable to the error code <b>P4</b> while in monitor mode.  P4-02/15: Fan PCB (M1F) Master / Sub  P4-03/16: Fan PCB (M2F) Master / Sub</p> </div> <pre> graph TD     Start[ ] --&gt; D1{The insulation resistance of the relevant fan motor is not more than 1 MΩ.}     D1 -- YES --&gt; A1[Replace the fan motor (M1F, M2F).]     D1 -- NO --&gt; D2{Turn ON the power supply. Does the error recur?}     D2 -- YES --&gt; A2[Replace the fan PCB.]     D2 -- NO --&gt; A3[Continue operation.]     </pre>



**Caution** Be sure to turn off the power switch before connecting or disconnecting connectors, or parts may be damaged.

Check for fan PCB applicable to the error code **P4** while in monitor mode.  
P4-02/15: Fan PCB (M1F) Master / Sub  
P4-03/16: Fan PCB (M2F) Master / Sub

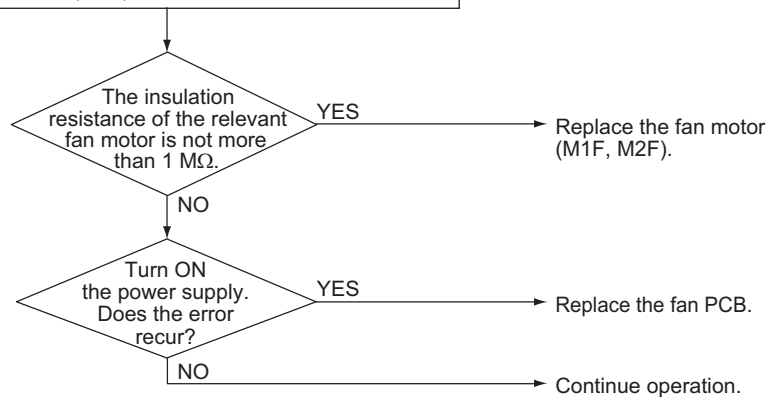

### 3.63 Field Setting Abnormality after Replacing Outdoor Unit Main PCB or Combination of PCB Abnormality

<b>Applicable Models</b>	All outdoor unit models
<b>Error Code</b>	<b>PJ</b>
<b>Method of Error Detection</b>	This error is detected according to communications with the inverter PCB.
<b>Error Decision Conditions</b>	Make judgement according to communication data on whether or not the type of the inverter PCB is correct.
<b>Supposed Causes</b>	<ul style="list-style-type: none"> <li>■ Mismatching of type of PCB</li> <li>■ Improper (or no) field setting after replacing outdoor unit main PCB</li> </ul>

**Troubleshooting**

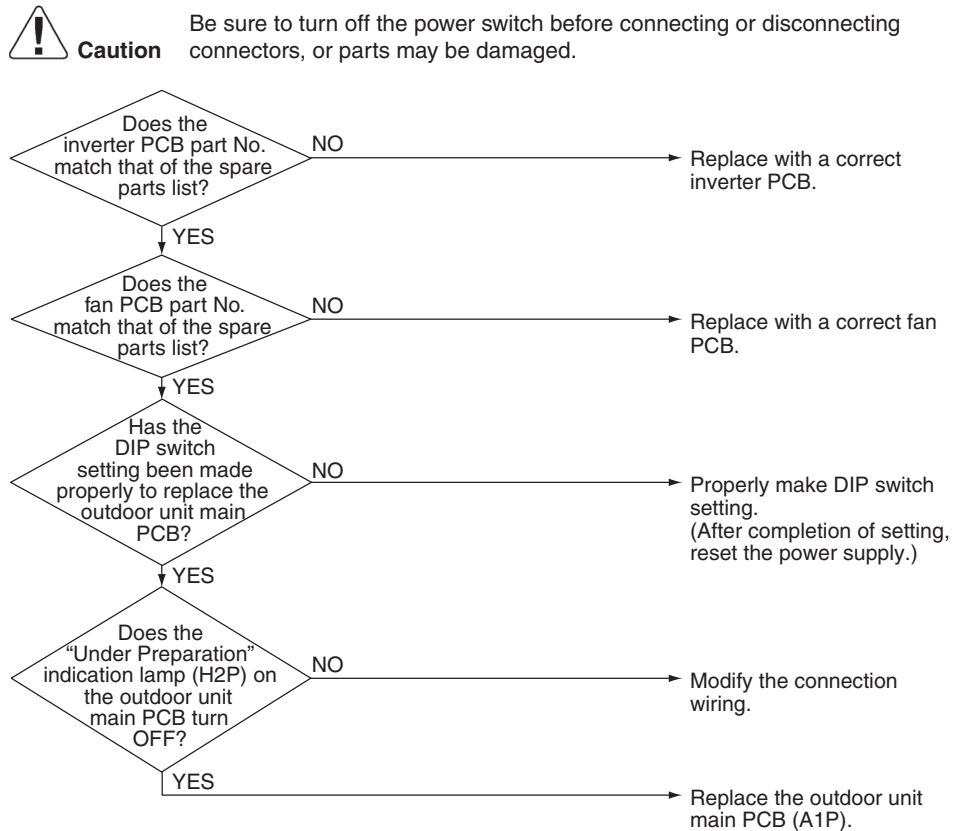



## 3.64 Refrigerant Shortage

<b>Applicable Models</b>	All outdoor unit models
<b>Error Code</b>	<b>U0</b>
<b>Method of Error Detection</b>	Detect refrigerant shortage according to a low pressure level or a difference in heat exchanging temperature from the suction pipe.
<b>Error Decision Conditions</b>	Low pressure becomes 0.1 MPa (14.5 psi) or less. * Error is not determined. The unit continues the operation.
<b>Supposed Causes</b>	<ul style="list-style-type: none"> <li>■ Refrigerant shortage or refrigerant clogging (wrong piping)</li> <li>■ Defective thermistor</li> <li>■ Defective low pressure sensor</li> <li>■ Defective outdoor unit main PCB</li> </ul>

### Troubleshooting

**Caution**

Be sure to turn off the power switch before connecting or disconnecting connectors, or parts may be damaged.

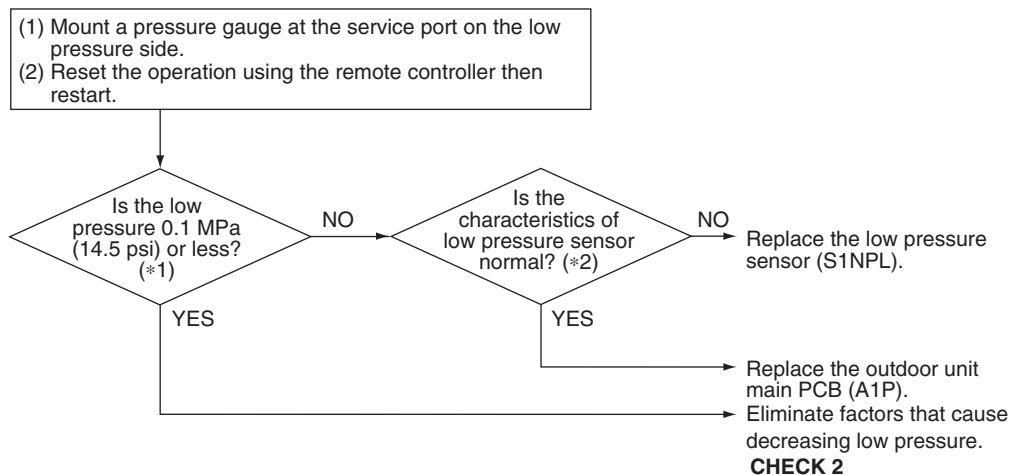
**Note(s)**

- \*1. Check the low pressure value by using pressure gauge in operation.
- \*2. Compare the actual measurement value by pressure sensor with the value by the pressure gauge.  
(To gain actual measurement value by pressure sensor, measure the voltage at the connector [between (2)-(3)] and then convert the value into pressure. **CHECK 12**)

**Reference**

**CHECK 2** Refer to page 450.



**Reference**

**CHECK 12** Refer to page 463.

### 3.65 Reverse Phase, Open Phase, Power Supply Frequency Issue

<b>Applicable Models</b>	All outdoor unit models
<b>Error Code</b>	<b>U1</b>
<b>Method of Error Detection</b>	The phase of each phase are detected by reverse phase detection circuit and right phase or reverse phase are judged.
<b>Error Decision Conditions</b>	When a power supply is reverse phase, or T-phase is open phase.
<b>Supposed Causes</b>	<ul style="list-style-type: none"> <li>■ Power supply reverse phase</li> <li>■ T phase open phase</li> <li>■ Defective outdoor unit main PCB (A1P)</li> <li>■ Power supply frequency issue</li> </ul>

**Troubleshooting**

 **Caution** Be sure to turn off the power switch before connecting or disconnecting connectors, or parts may be damaged.

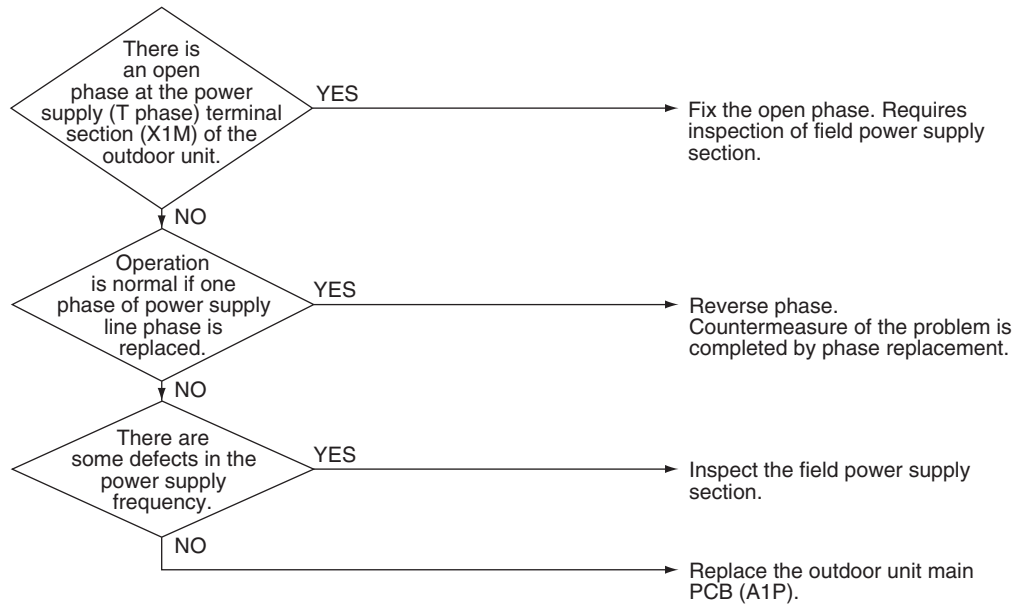

## 3.66 Power Supply Insufficient or Instantaneous Abnormality

<b>Applicable Models</b>	All outdoor unit models
<b>Error Code</b>	<b>U2</b>
<b>Method of Error Detection</b>	Detect the voltage of capacitor of the main circuit in the inverter PCB.
<b>Error Decision Conditions</b>	When the voltage in the DC circuit (between diode module and power module) falls below 190 VDC (for 208/230 V models) or 380 VDC (for 460 V models).
<b>Supposed Causes</b>	<ul style="list-style-type: none"> <li>■ Abnormal power supply voltage</li> <li>■ Instantaneous power failure</li> <li>■ Open phase</li> <li>■ Defective inverter PCB</li> <li>■ Defective outdoor unit main PCB</li> <li>■ Defective compressor</li> <li>■ Defective main circuit wiring</li> <li>■ Defective fan motor</li> <li>■ Defective connection of signal cable</li> </ul>

### Troubleshooting

**Caution**

Be sure to turn off the power switch before connecting or disconnecting connectors, or parts may be damaged.

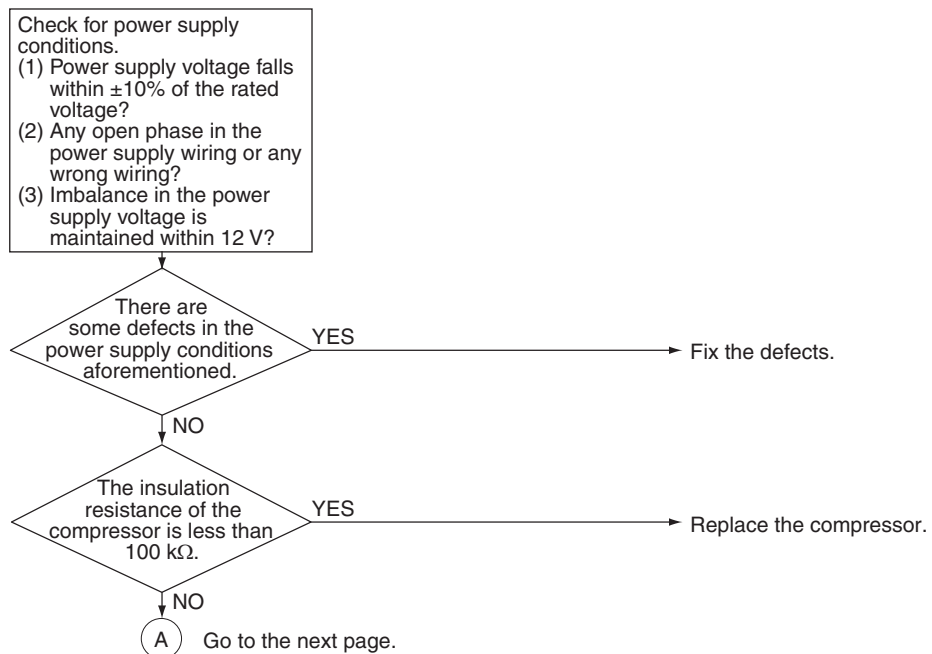

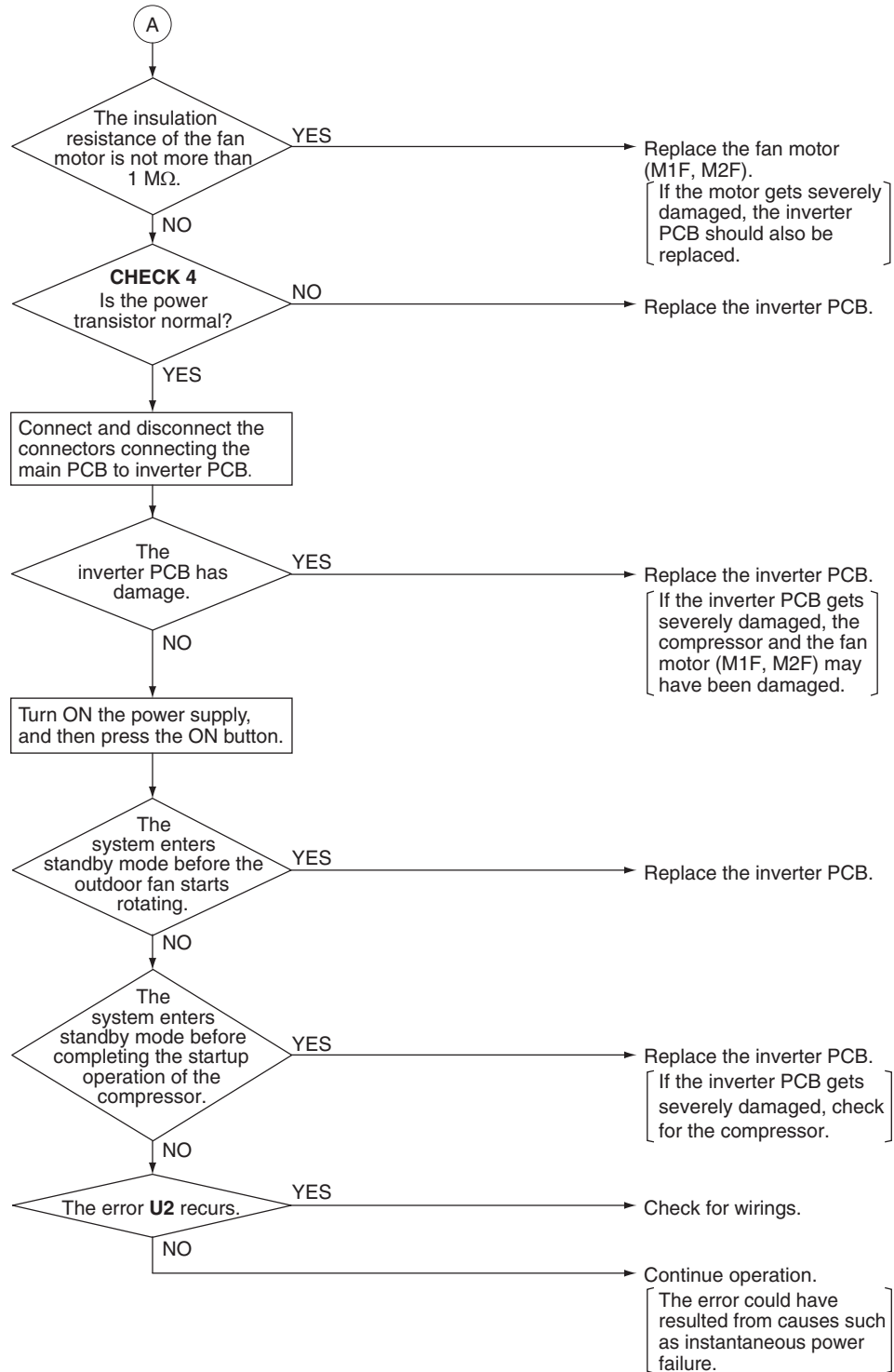

Reference CHECK 4 Refer to page 454.

## 3.67 Check Operation Not Executed

**Applicable Models** All outdoor unit models

**Error Code** **U3**

**Method of Error Detection** The check operation has not been executed.

**Error Decision Conditions** Error is decided when the unit starts operation without check operation.

**Supposed Causes** Check operation not executed.

### Troubleshooting



**Caution**

Be sure to turn off the power switch before connecting or disconnecting connectors, or parts may be damaged.

The contents of individual failures vary with sub code. Ensure the sub code, and then go to the following:

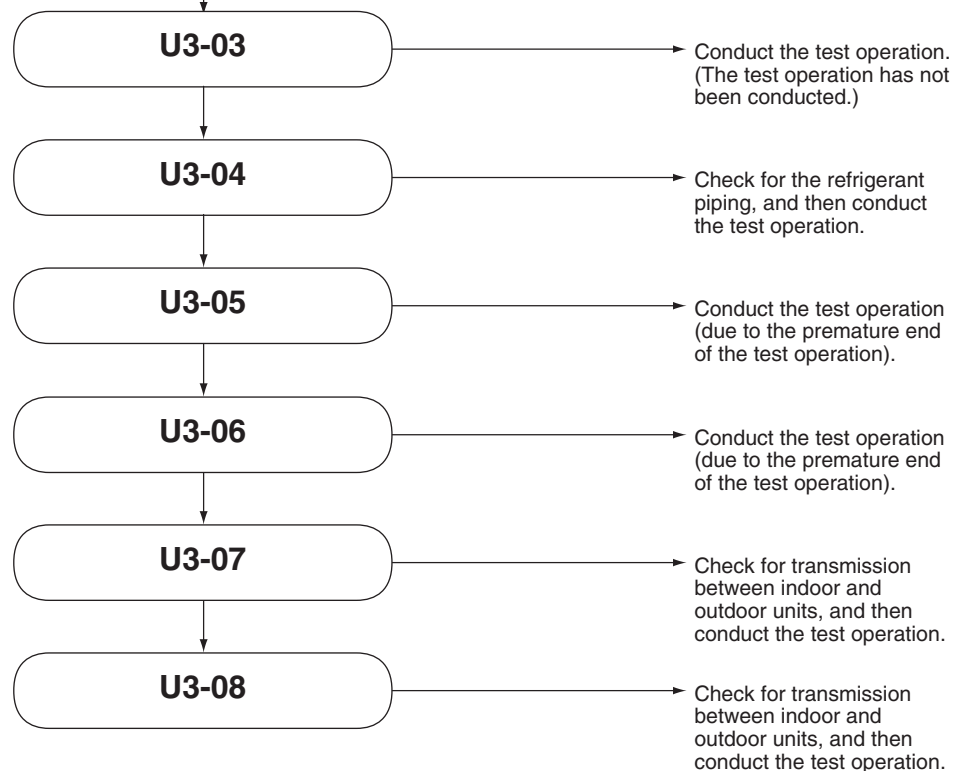

### 3.68 Transmission Error between Indoor Units and Outdoor Units, Open Phase in Power Supply Wiring

<b>Applicable Models</b>	All indoor unit models All outdoor unit models
<b>Error Code</b>	<b>U4</b>
<b>Method of Error Detection</b>	Microcomputer checks if transmission between indoor and outdoor units is normal.
<b>Error Decision Conditions</b>	Transmission is not carried out normally for a certain amount of time.
<b>Supposed Causes</b>	<ul style="list-style-type: none"> <li>■ Open phase in power supply wiring</li> <li>■ Short circuit in indoor-outdoor or outdoor-outdoor transmission wiring (F1/F2), or wrong wiring</li> <li>■ Outdoor unit power supply is OFF</li> <li>■ System address does not match</li> <li>■ Defective indoor unit control PCB</li> <li>■ Defective outdoor unit main PCB</li> <li>■ Multi-tenant function is ON.</li> </ul>

Troubleshooting



**Caution**

Be sure to turn off the power switch before connecting or disconnecting connectors, or parts may be damaged.

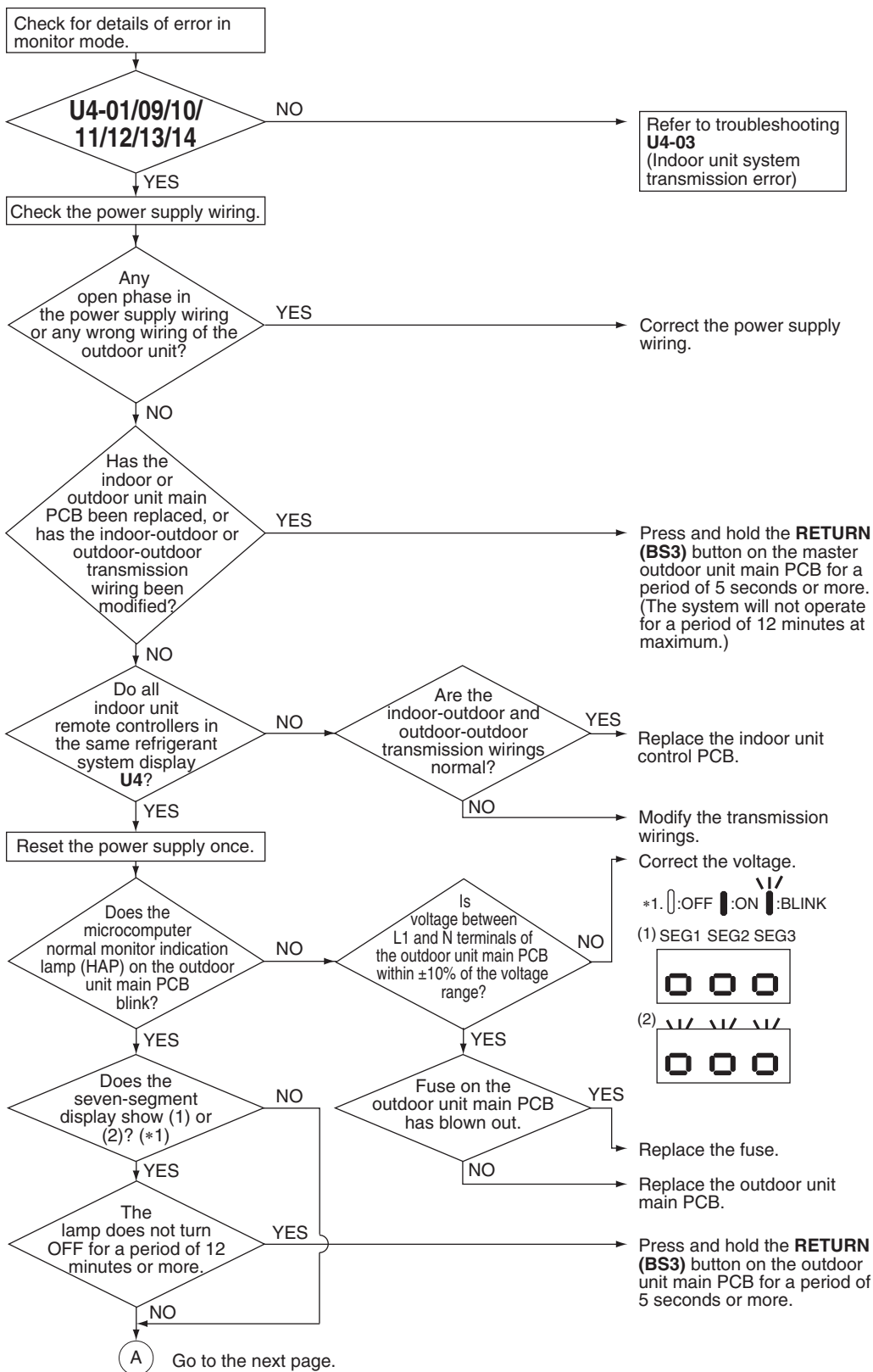

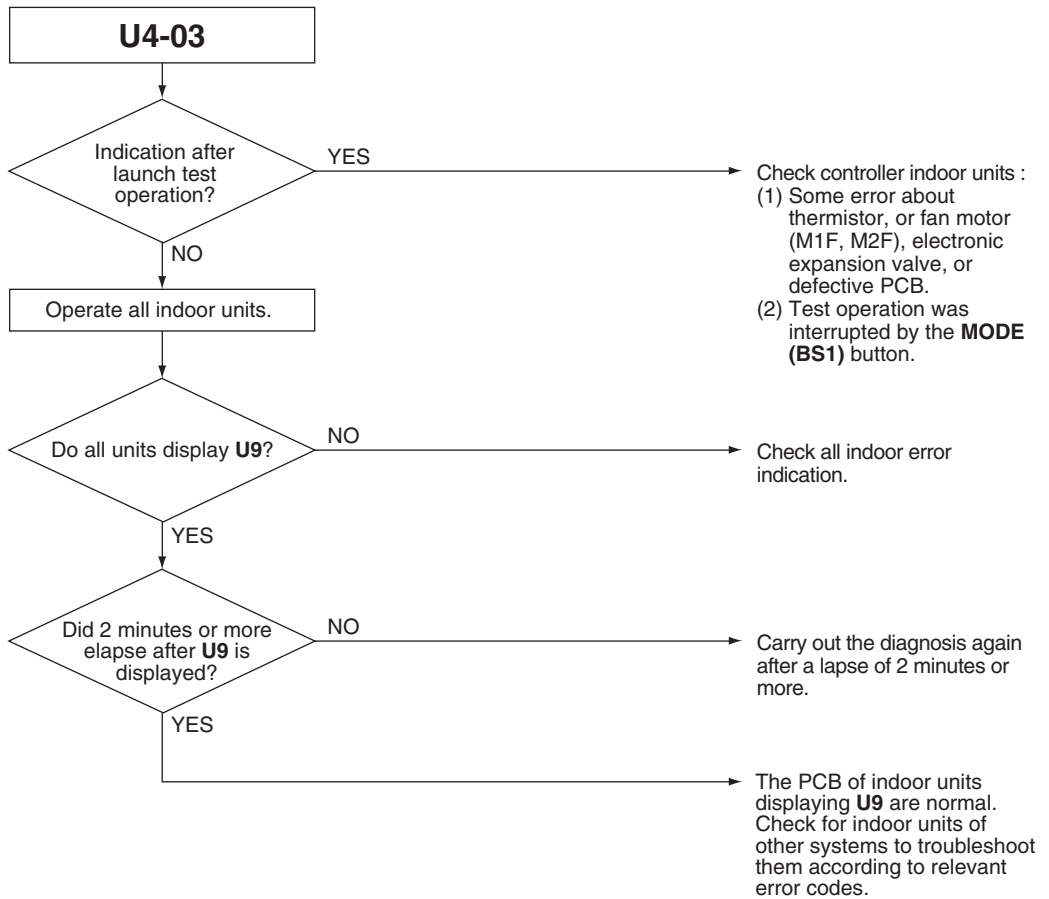
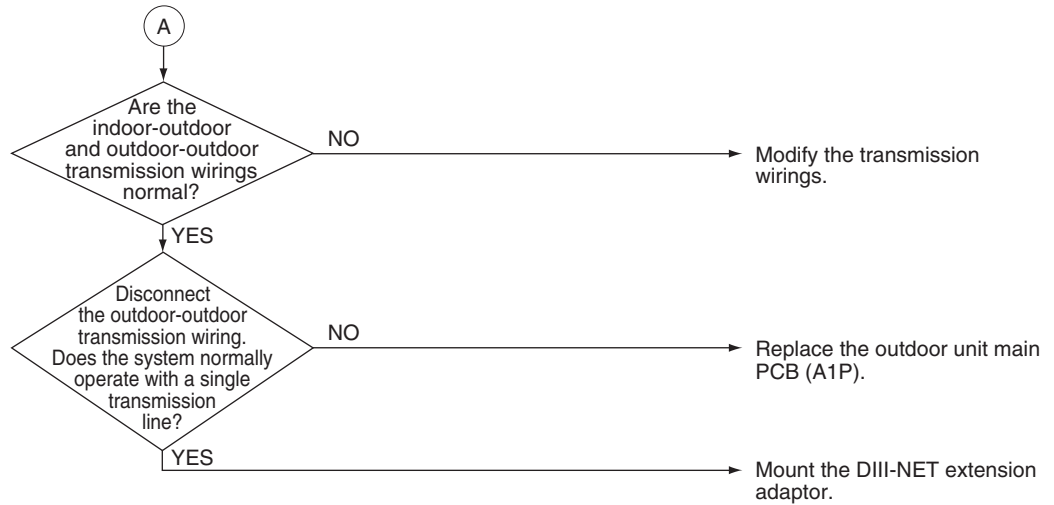



## 3.69 Transmission Error between Remote Controller and Indoor Unit

### Applicable Models

All indoor unit models

### Error Code

**U5**

### Method of Error Detection

Microcomputer checks if transmission between indoor unit and remote controller is normal.

### Error Decision Conditions

Transmission is not carried out normally for a certain amount of time.

### Supposed Causes

- Transmission error between indoor unit and remote controller
- Connection of 2 main remote controllers (when using 2 remote controllers)
- Defective indoor unit control PCB
- Defective remote controller PCB
- Transmission error caused by noise

### Troubleshooting



#### Caution

Be sure to turn off the power switch before connecting or disconnecting connectors, or parts may be damaged.

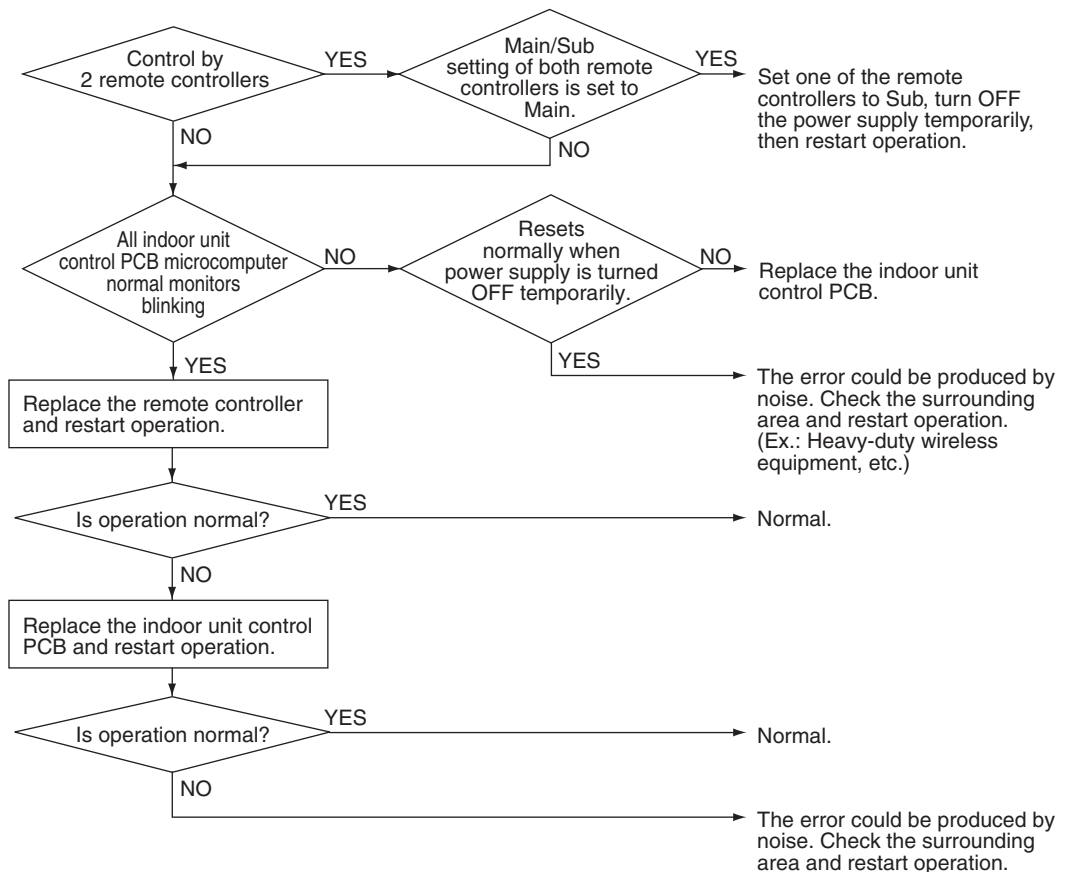

#### Reference

Refer to page 126 for Main/Sub setting.

## 3.70 Transmission Error between Outdoor Units

---

<b>Applicable Models</b>	All outdoor unit models
<b>Error Code</b>	<b>U7</b>
<b>Method of Error Detection</b>	Microcomputer checks if transmission between outdoor units is normal.
<b>Error Decision Conditions</b>	When transmission is not carried out normally for a certain amount of time
<b>Supposed Causes</b>	<ul style="list-style-type: none"><li>■ Connection error of transmission wirings between outdoor unit and external control adaptor for outdoor unit</li><li>■ Connection error of transmission wirings between outdoor units</li><li>■ Cool/Heat selection setting error</li><li>■ Cool/Heat unified address setting error (functional unit, external control adaptor for outdoor unit)</li><li>■ Defective outdoor unit main PCB</li><li>■ Defective external control adaptor for outdoor unit</li></ul>

Troubleshooting



**Caution** Be sure to turn off the power switch before connecting or disconnecting connectors, or parts may be damaged.

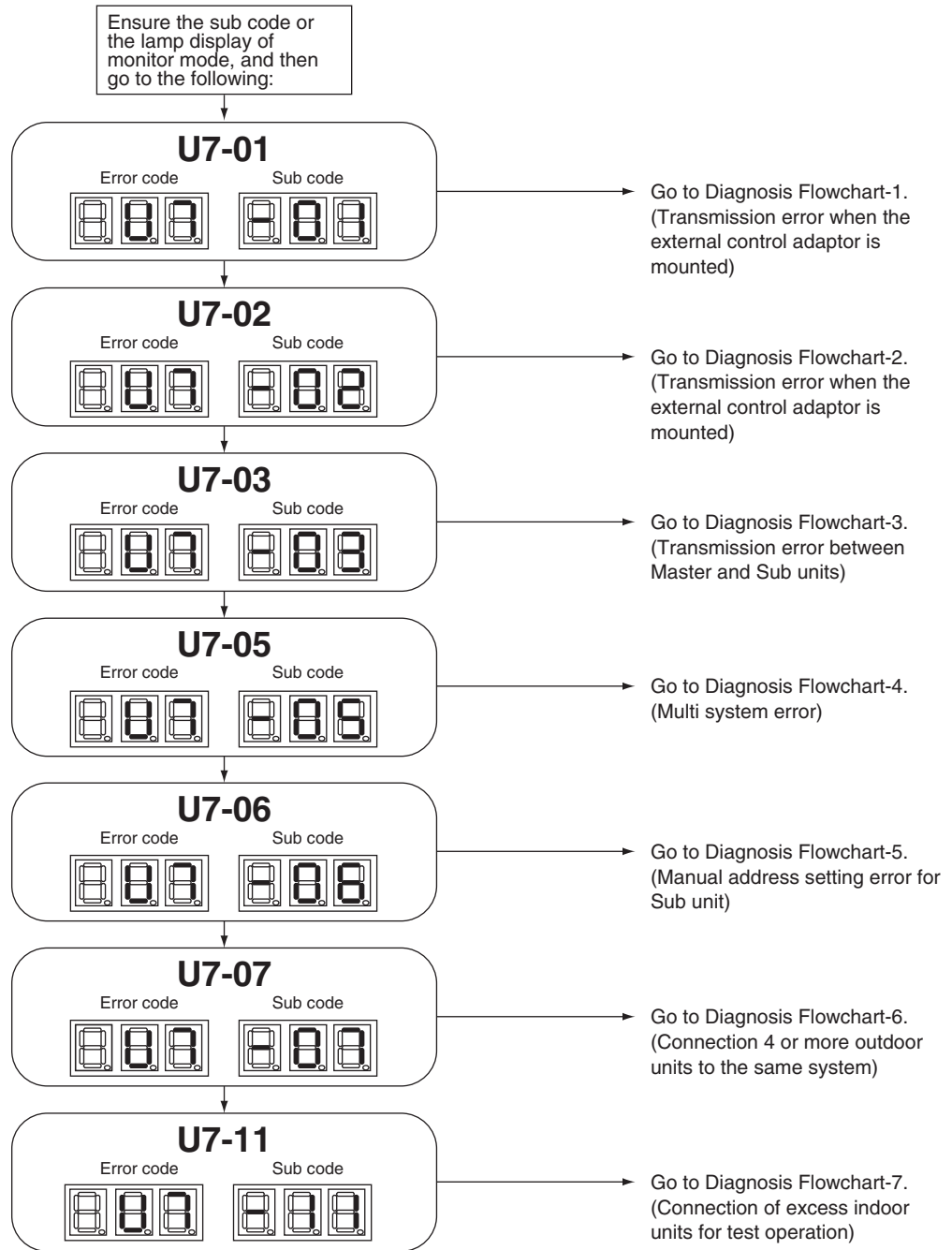

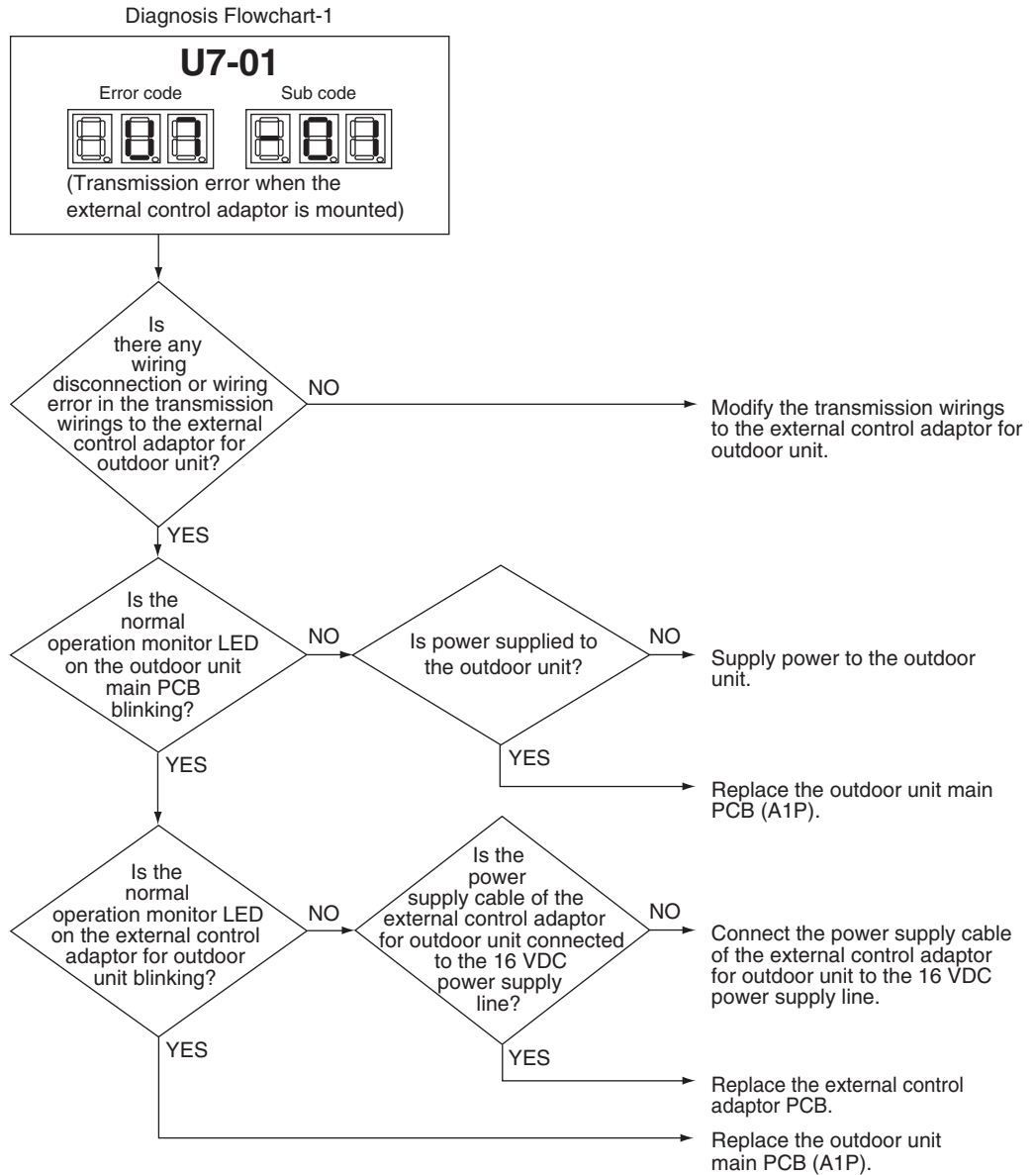

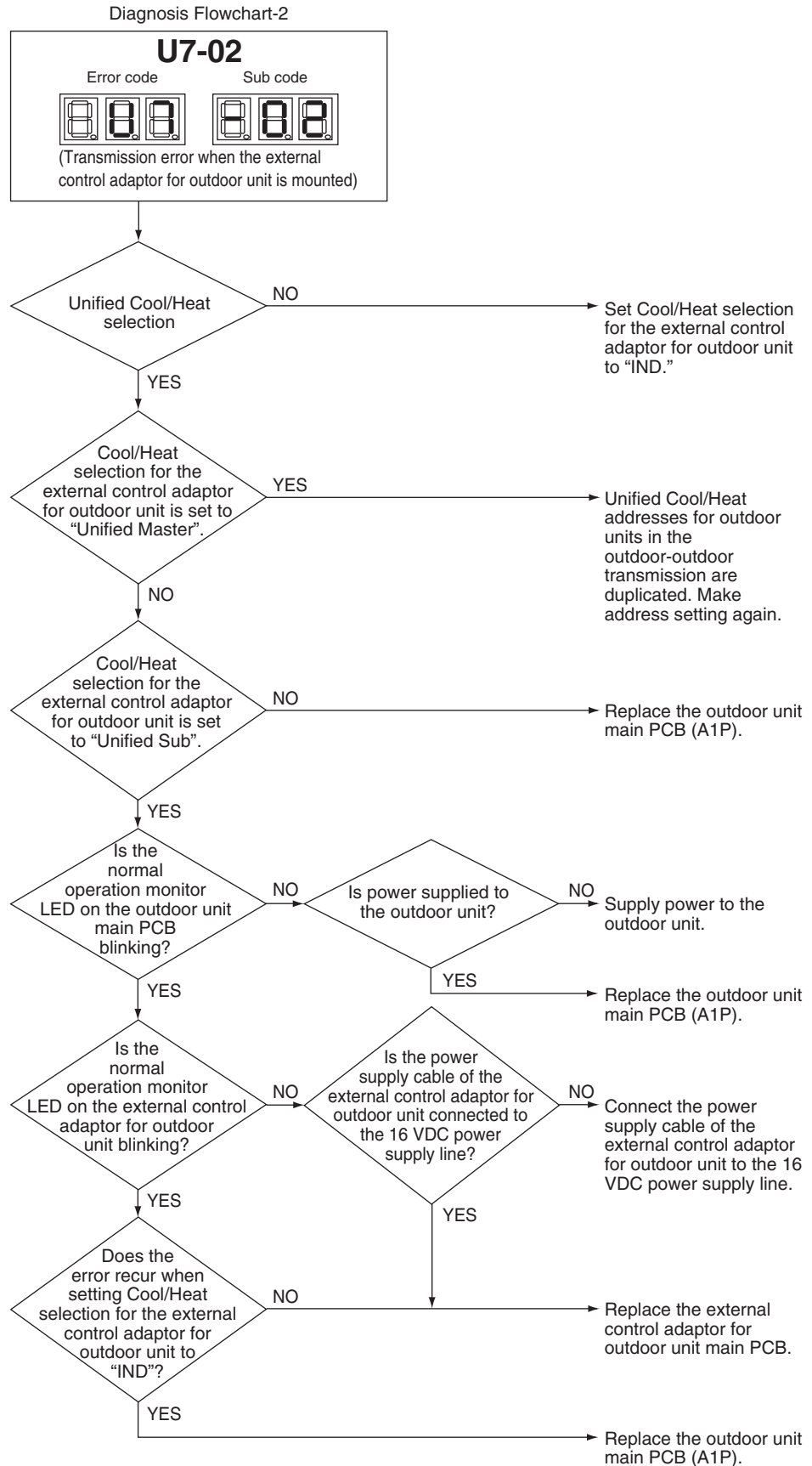

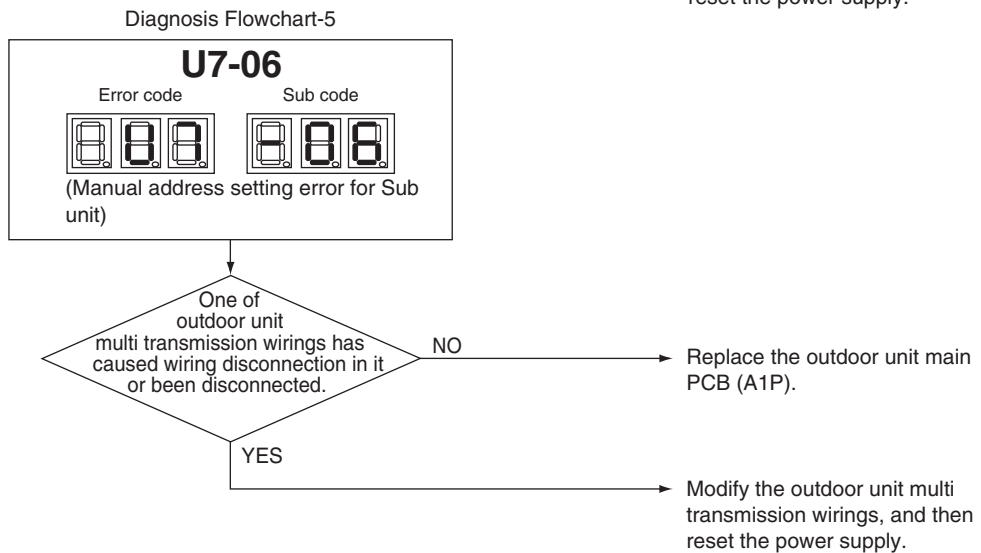
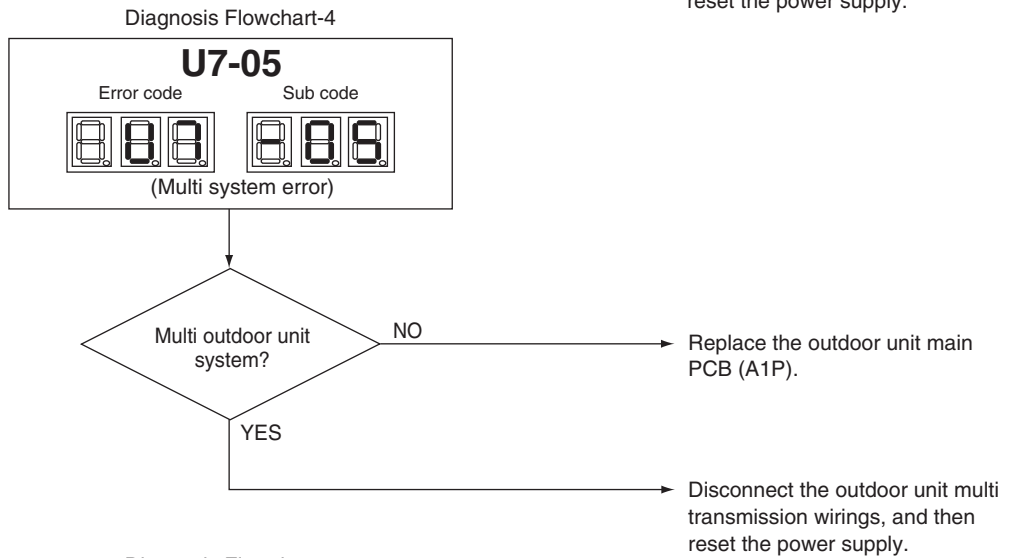
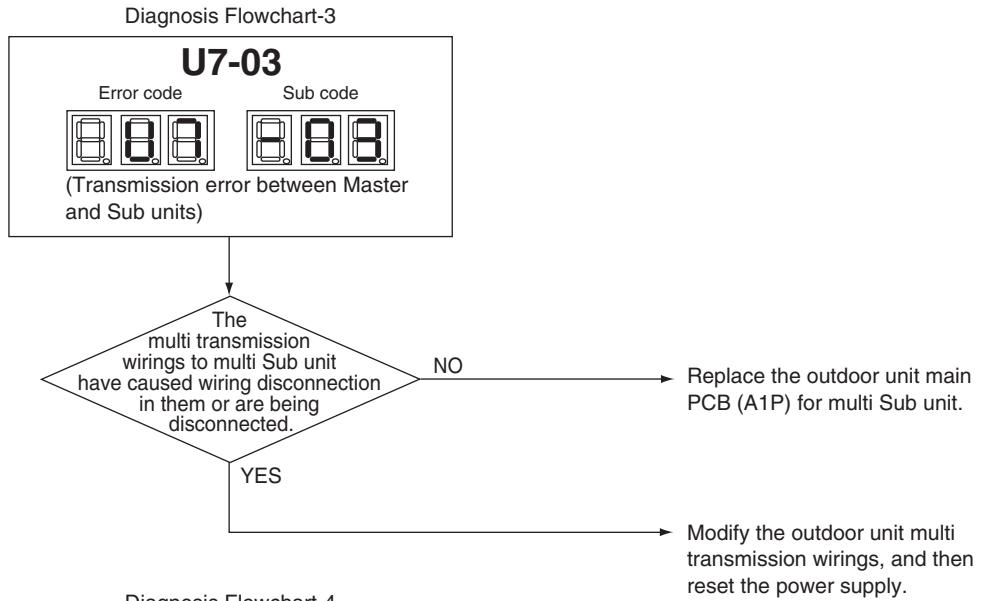

Diagnosis Flowchart-6

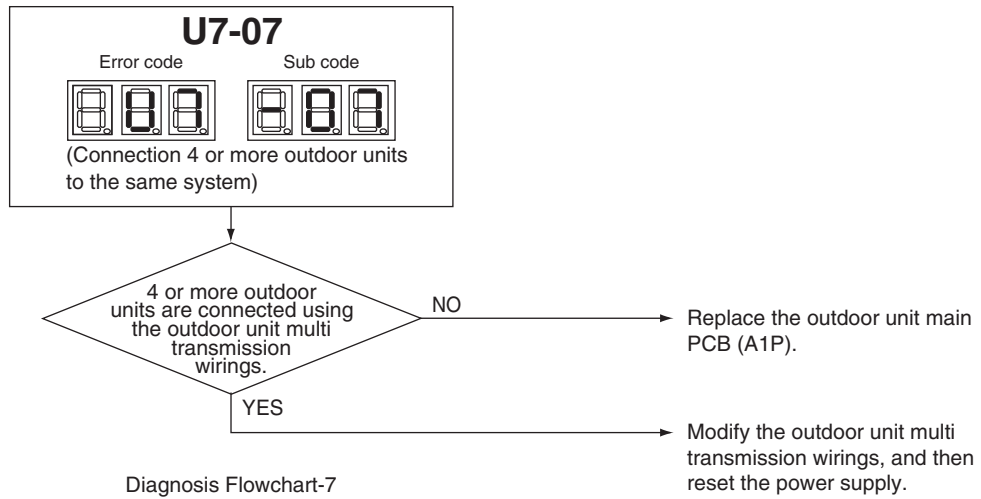

Diagnosis Flowchart-7

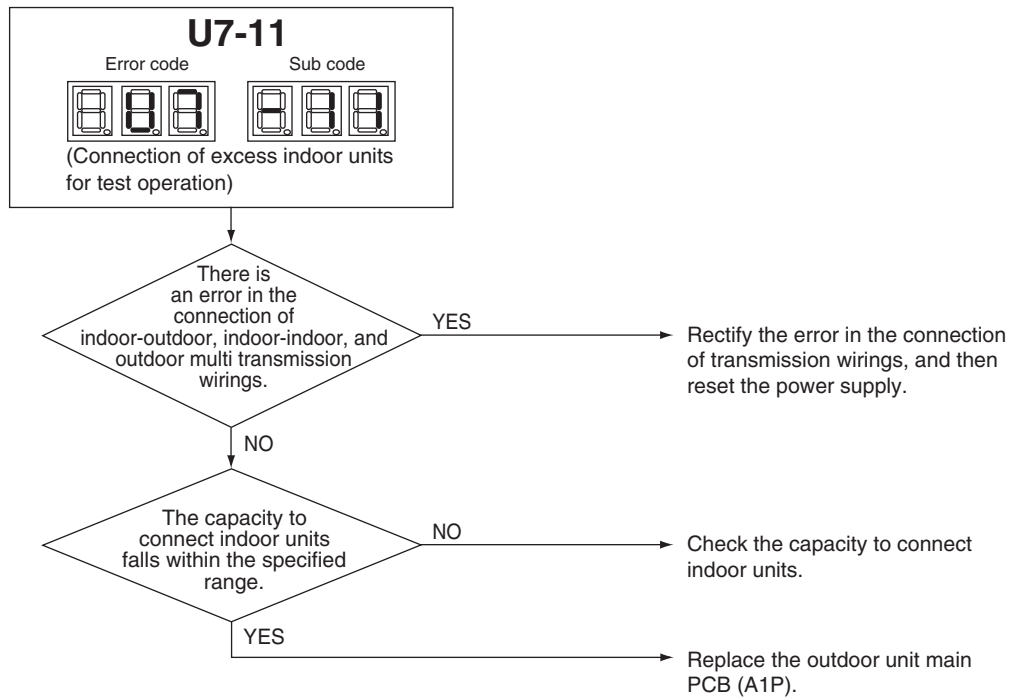

### 3.71 Transmission Error between Main and Sub Remote Controllers

<b>Applicable Models</b>	All indoor unit models
<b>Error Code</b>	<b>U8</b>
<b>Method of Error Detection</b>	In case of controlling with 2 remote controllers, check the system using microcomputer if signal transmission between indoor unit and remote controller (main and sub remote controller) is normal.
<b>Error Decision Conditions</b>	When transmission is not carried out normally for a certain amount of time.
<b>Supposed Causes</b>	<ul style="list-style-type: none"> <li>■ Transmission error between main and sub remote controller</li> <li>■ Connection between sub remote controllers</li> <li>■ Defective remote controller PCB</li> </ul>

**Troubleshooting**

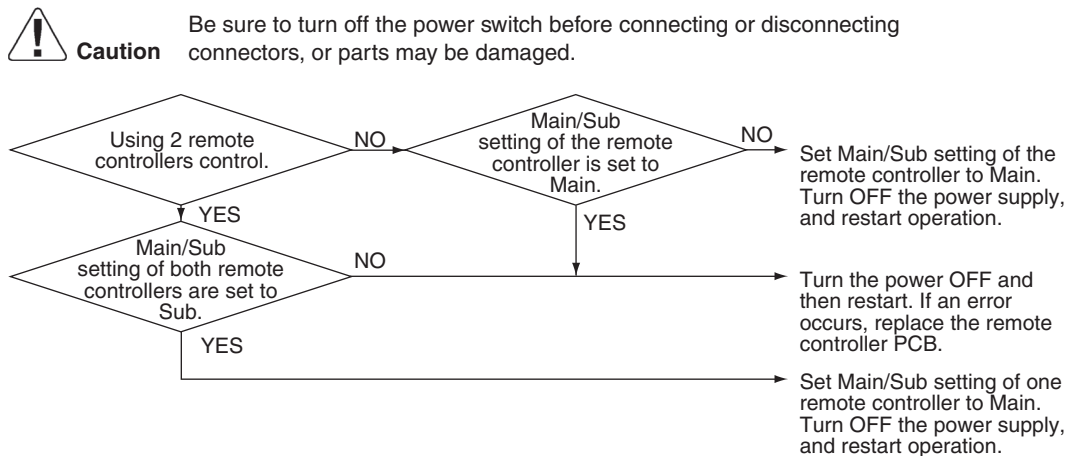

 **Reference** Refer to page 126 for Main/Sub setting.



## 3.72 Transmission Error between Indoor Units and Outdoor Units in the Same System

<b>Applicable Models</b>	All indoor unit models All outdoor unit models
<b>Error Code</b>	<b>U9</b>
<b>Method of Error Detection</b>	Detect the error signal for the other indoor unit within the circuit by outdoor unit main PCB.
<b>Error Decision Conditions</b>	When the error decision is made on any other indoor unit within the system concerned
<b>Supposed Causes</b>	<ul style="list-style-type: none"> <li>■ Transmission error between other indoor and outdoor units</li> <li>■ Defective electronic expansion valve of other indoor unit</li> <li>■ Defective indoor unit control PCB of other indoor unit</li> <li>■ Improper connection of transmission wiring between indoor and outdoor unit</li> <li>■ Multi-tenant function is ON.</li> </ul>

### Troubleshooting

**Caution**

Be sure to turn off the power switch before connecting or disconnecting connectors, or parts may be damaged.

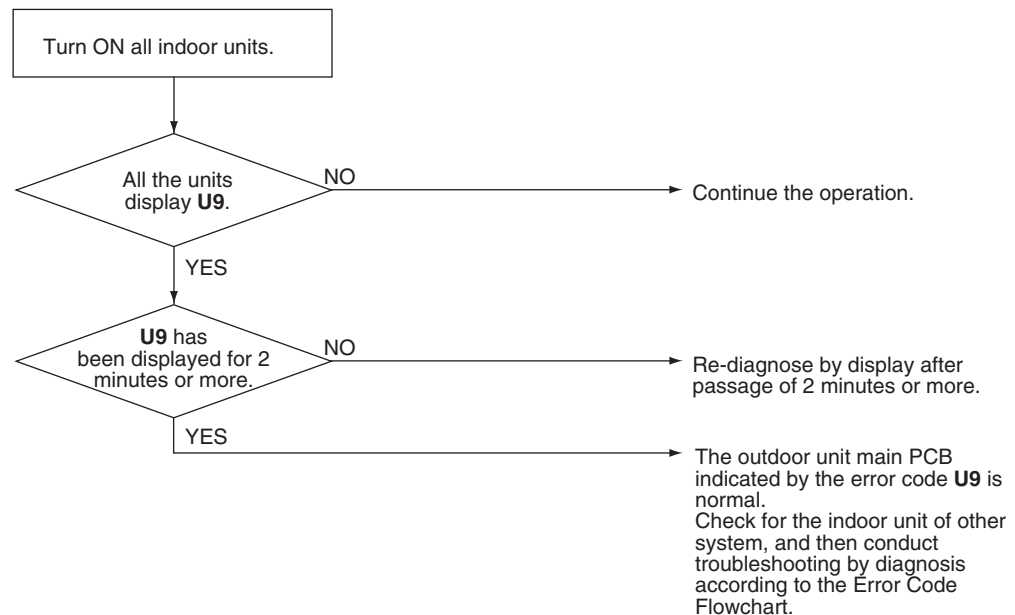

### 3.73 Improper Combination of Indoor, Branch Selector and Outdoor Units

**Applicable Models**

All indoor unit models  
 Branch Selector unit  
 All outdoor unit models

**Error Code**

**UA**

**Method of Error Detection**

- A difference occurs in data by the type of refrigerant between indoor, Branch Selector and outdoor units.
- The number of indoor units is out of the allowable range.
- Signal transmission between indoor, Branch Selector and outdoor units is abnormal.

**Error Decision Conditions**

The error decision is made as soon as either of the abnormalities aforementioned is detected.

**Supposed Causes**

- Excess of connected indoor units
- Defective outdoor unit main PCB
- Mismatch of the refrigerant type of indoor and outdoor unit.
- Setting of outdoor unit main PCB was not carried out after replacing to spare PCB.

## Troubleshooting



**Caution** Be sure to turn off the power switch before connecting or disconnecting connectors, or parts may be damaged.

Ensure the sub code or the lamp display of monitor mode, and then go to the following:

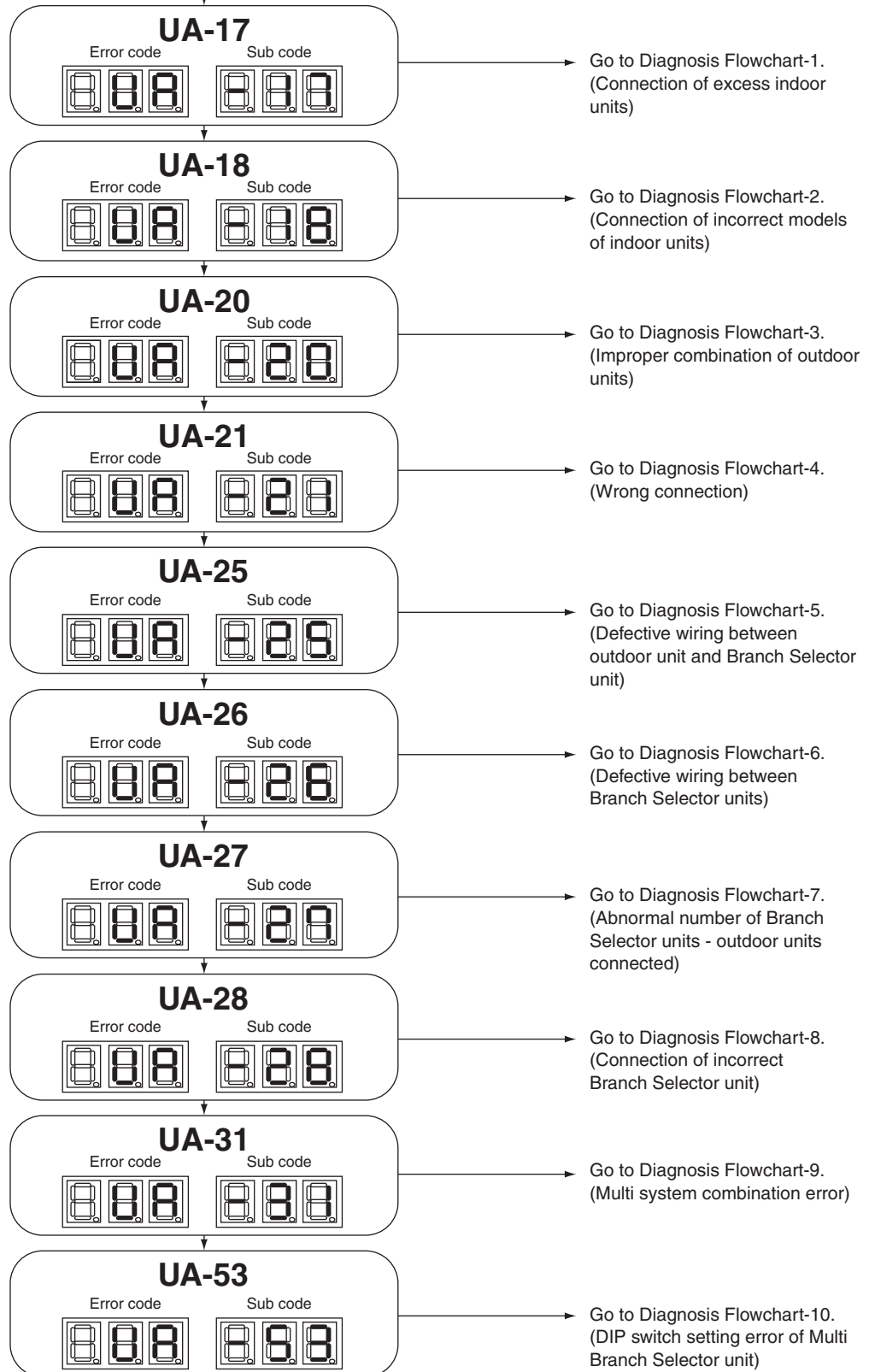

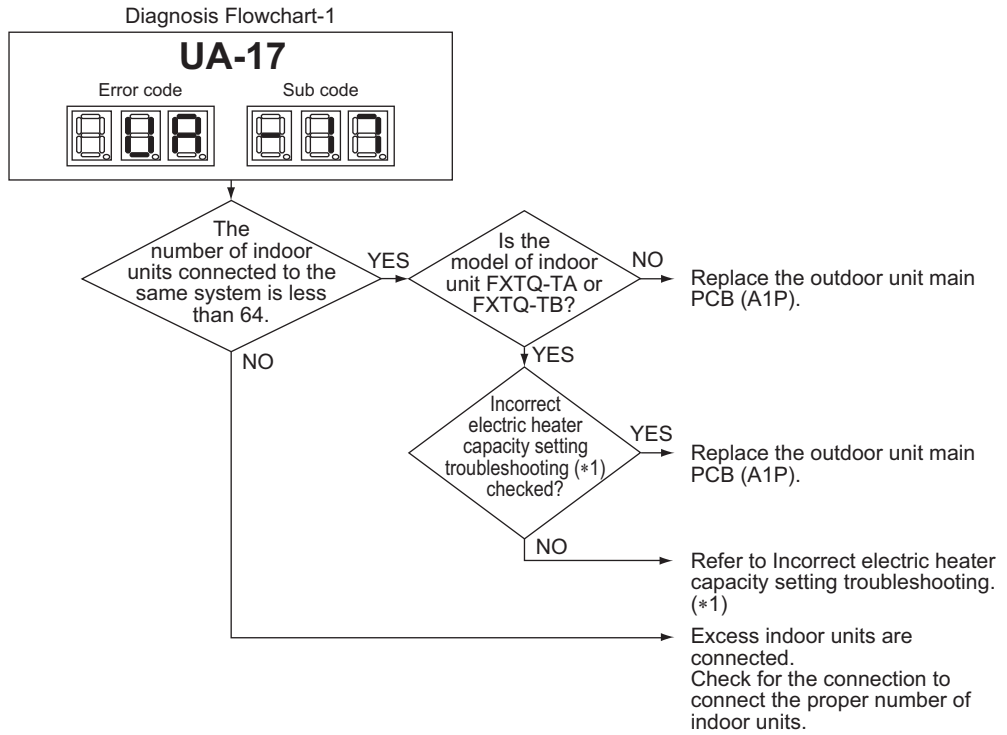

**i** Note(s) \*1. Refer to page 439.

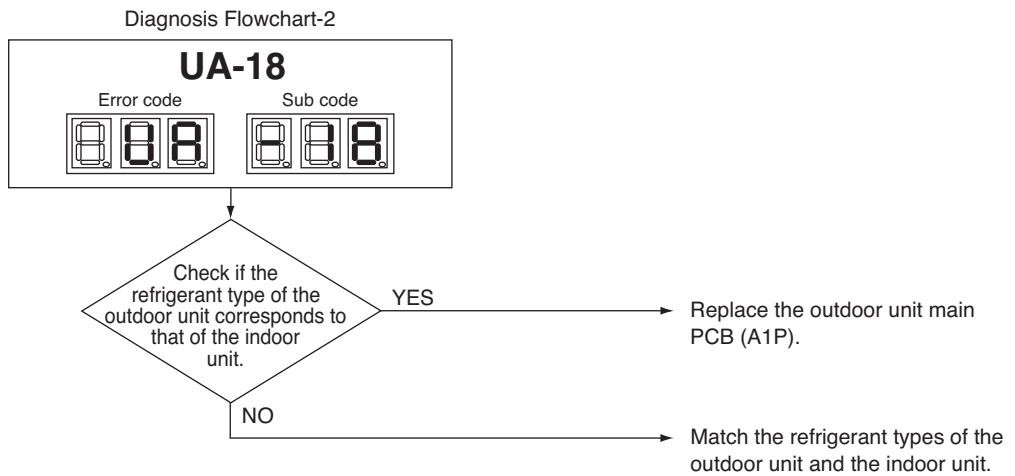

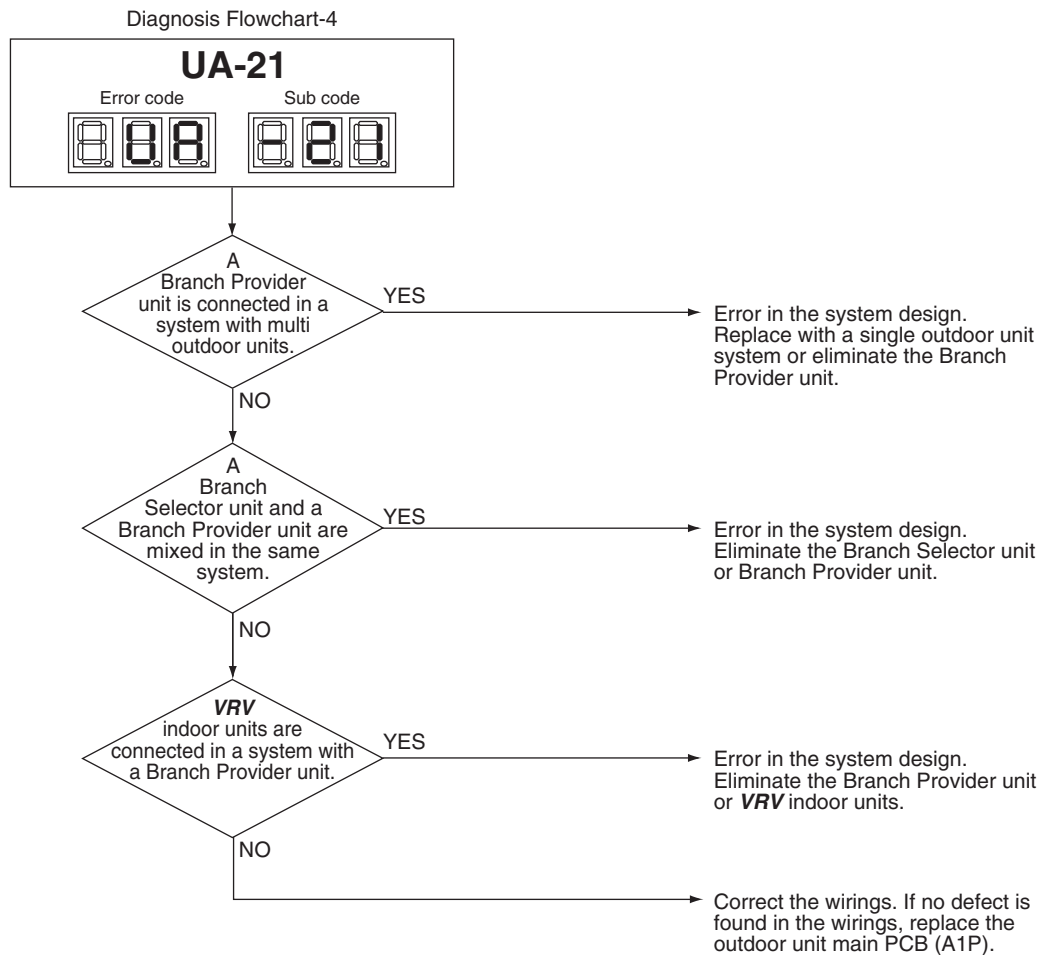
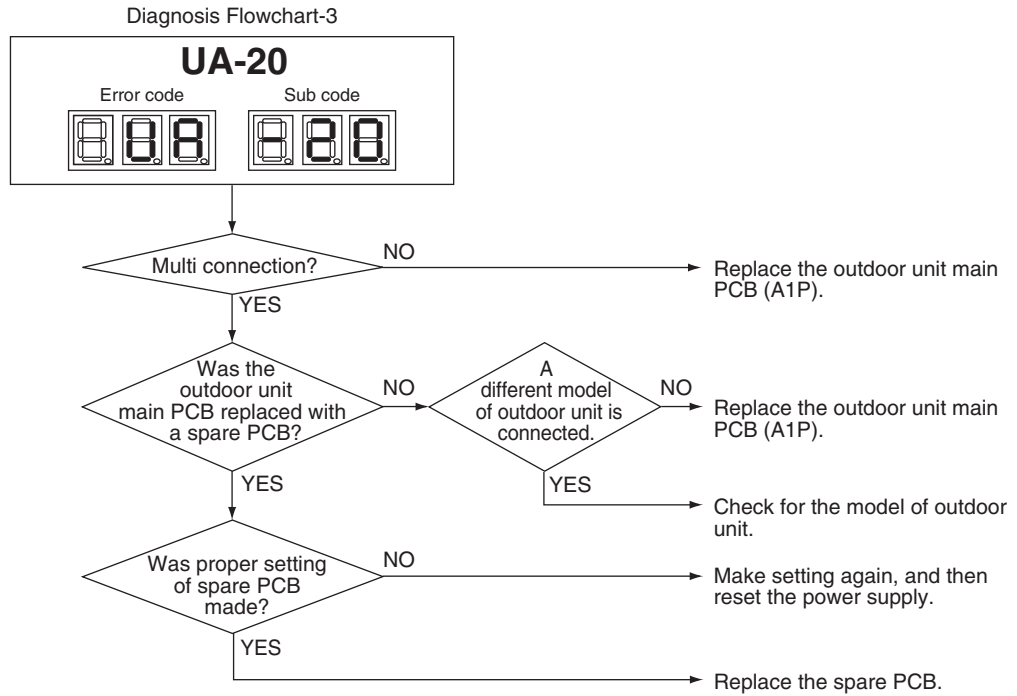

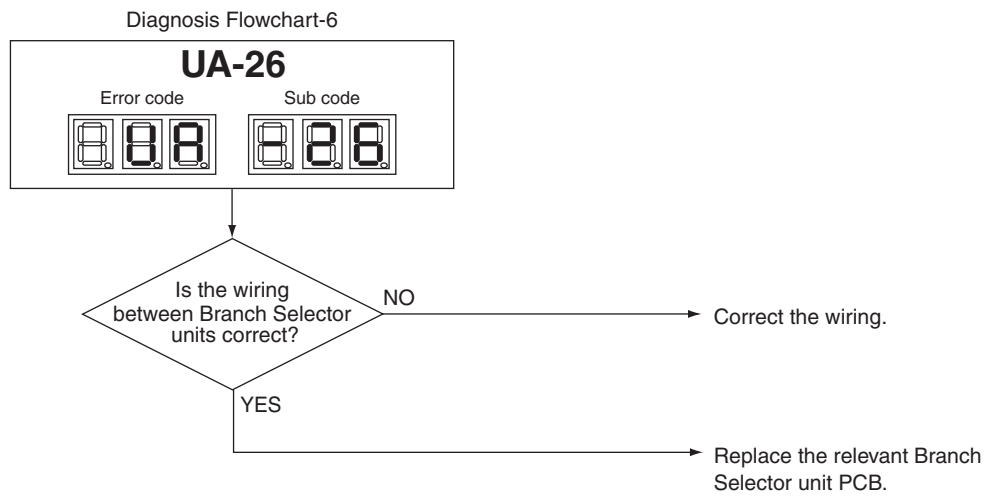
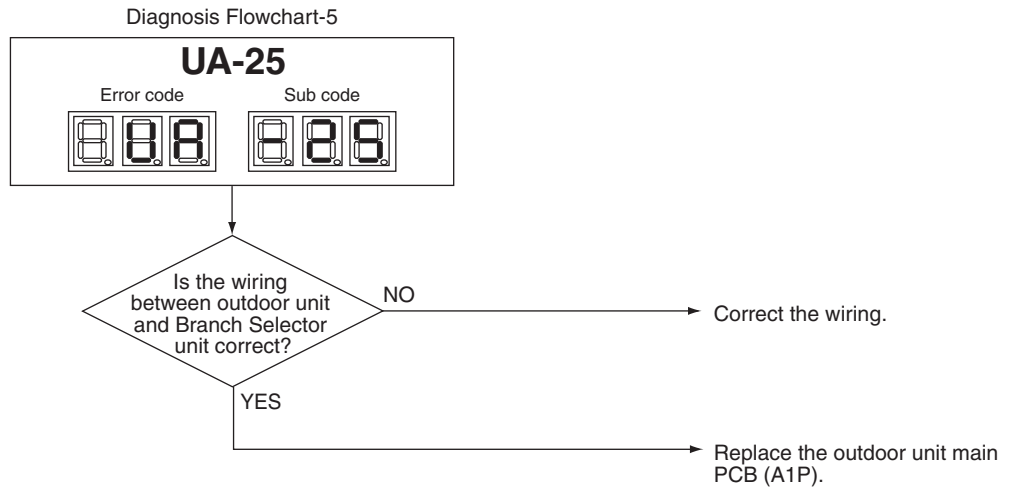

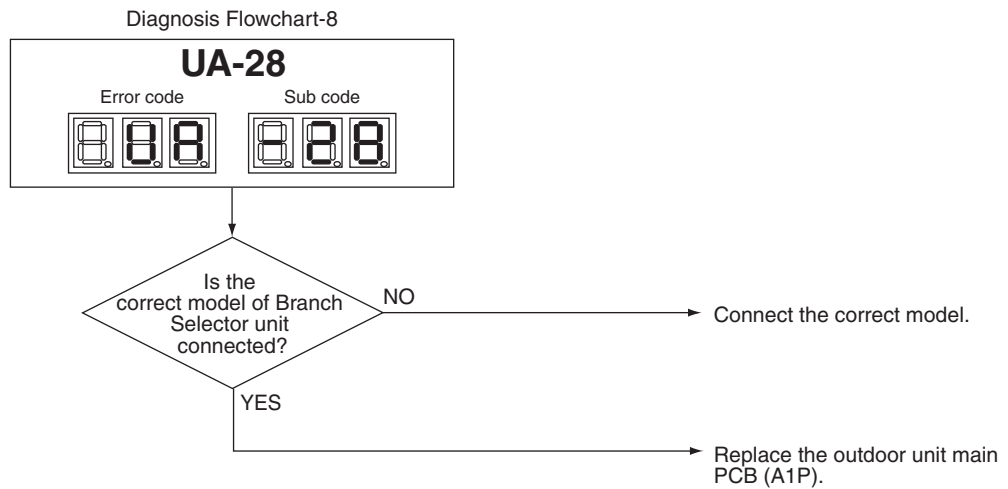
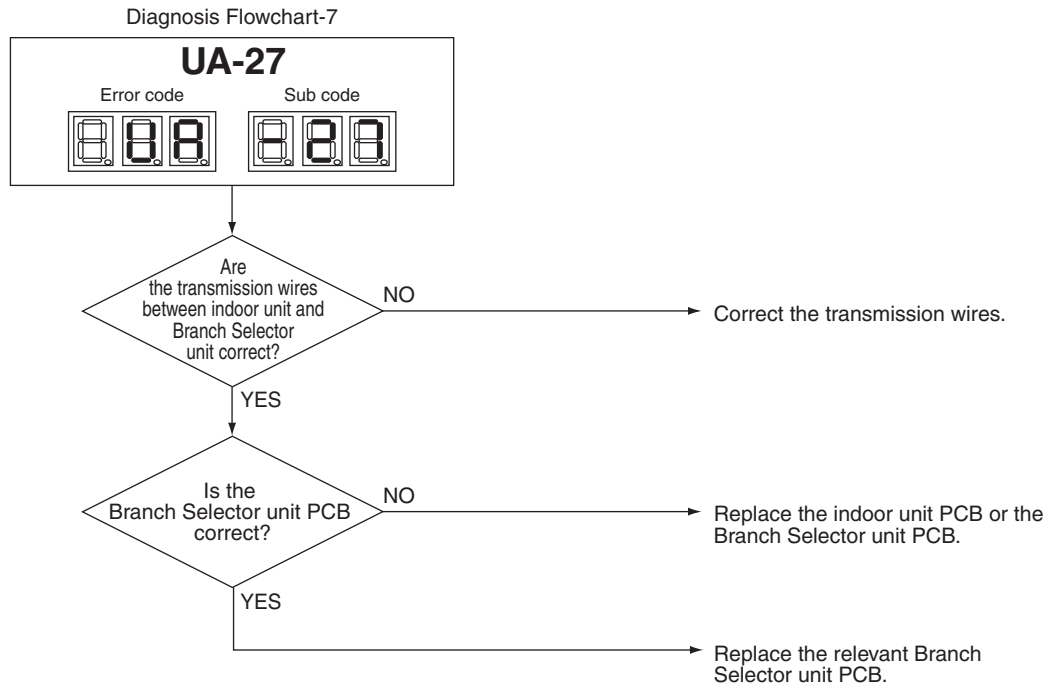

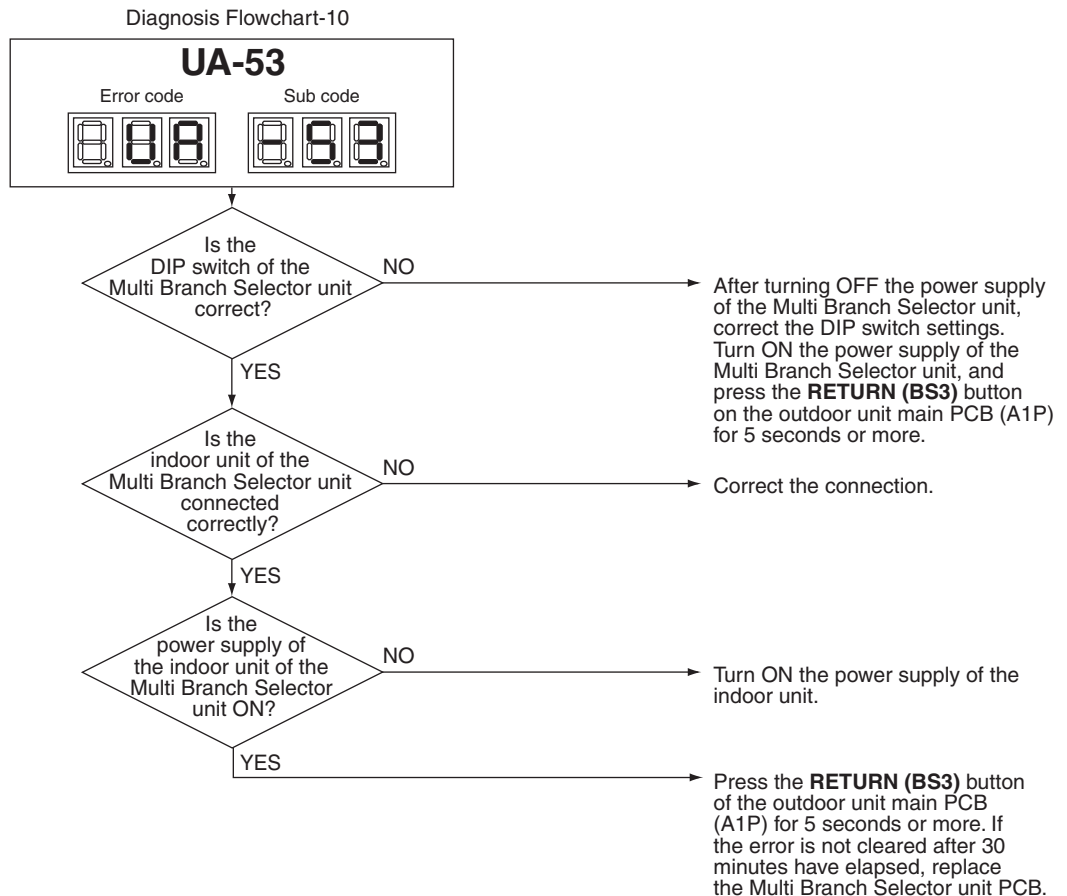
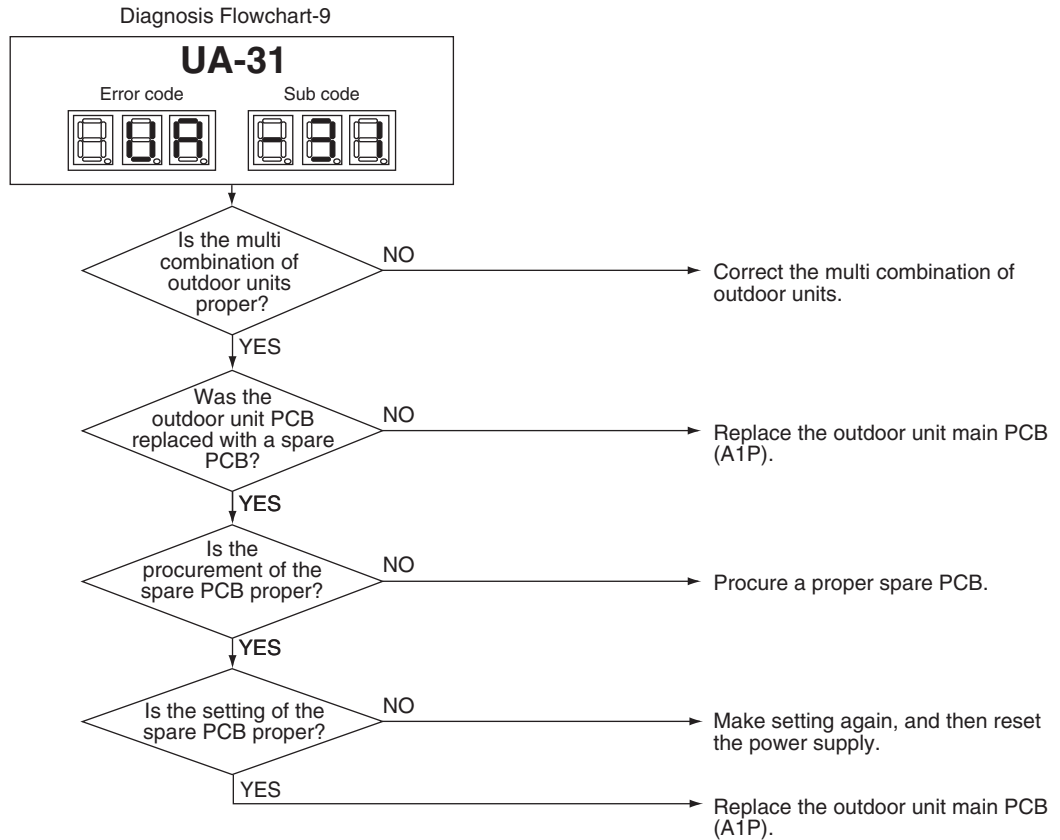



## 3.74 Incorrect Gas Furnace Connecting Number

---

**Applicable Models**CXTQ-TA

---

**Error Code****UA**

---

**Outline**Two or more "CXTQ-TA + gas furnace" and other indoor units other than CXTQ-TA are connected.

---

**Error Decision Conditions**Check that two or more "CXTQ-TA + gas furnace" and other indoor units other than CXTQ-TA are not connected.

---

**Operation After Error Codes Decided**

- The error code **UA** is displayed on the remote controller.
- Change to be the system that one "CXTQ-TA + gas furnace" and other indoor units other than CXTQ-TA are connected.

### 3.75 Incorrect Electric Heater Capacity Setting

<b>Applicable Models</b>	FXTQ-TA, FXTQ-TB
<b>Error Code</b>	<b>UA-17</b>
<b>Outline</b>	<p>After attaching optional electric heater, if the electric heater capacity setting (11 (21)-5) is made mistakenly for heaters not featured in the lineup, heating via unintended levels of airflow will be prevented.</p> <p>However, the electric heater will be operable for convenience.</p>
<b>Error Decision Conditions</b>	Checks when the capacity setting (11 (21)-5) of the electric heater has been set to a non-applicable value.
<b>Operation After Error Codes Decided</b>	<ul style="list-style-type: none"> <li>■ The error code <b>UA-17</b> is displayed on the remote controller.</li> <li>■ Indoor units can operate continuously.</li> <li>■ Incorrect setting is kept.</li> <li>■ Even if the ON condition for electric heater 2 is established, only electric heater 1 will be set to ON. (Electric heater 1 set to ON, electric heater 2 set to OFF) (In order to deliver in terms of user-friendliness and safety, the electric heater can operate at the lowest possible power levels.)</li> <li>■ The airflow of the fan during operation of the electric heater will be set to the largest value within the CFM dictated by the capacity of each of the electric heaters (electric heater 1, electric heater 2 both set to ON).</li> <li>■ All other operations are the same as during normal operation.</li> </ul>

## 3.76 Address Duplication of Centralized Controller

**Applicable Models** All indoor unit models  
Centralized controller

**Error Code** **UC**

**Method of Error Detection** The principal indoor unit detects the same address as that of its own on any other indoor unit.

**Error Decision Conditions** The error decision is made as soon as the abnormality aforementioned is detected.

**Supposed Causes**

- Address duplication of centralized controller
- Defective indoor unit PCB

### Troubleshooting



**Caution**

Be sure to turn off the power switch before connecting or disconnecting connectors, or parts may be damaged.

The centralized address is duplicated.

→ Make setting change so that the centralized address will not be duplicated.

### 3.77 Transmission Error between Centralized Controller and Indoor Unit

<b>Applicable Models</b>	All indoor unit models Central remote controller Schedule timer intelligent Touch Controller
<b>Error Code</b>	<b>UE</b>
<b>Method of Error Detection</b>	Microcomputer checks if transmission between indoor unit and centralized controller is normal.
<b>Error Decision Conditions</b>	When transmission is not carried out normally for a certain amount of time
<b>Supposed Causes</b>	<ul style="list-style-type: none"> <li>■ Transmission error between optional controllers for centralized controller and indoor unit</li> <li>■ Connector for setting main controller is disconnected. (or disconnection of connector for independent / combined use changeover switch.)</li> <li>■ Defective PCB for centralized controller</li> <li>■ Defective indoor unit PCB</li> </ul>

Troubleshooting



**Caution** Be sure to turn off the power switch before connecting or disconnecting connectors, or parts may be damaged.

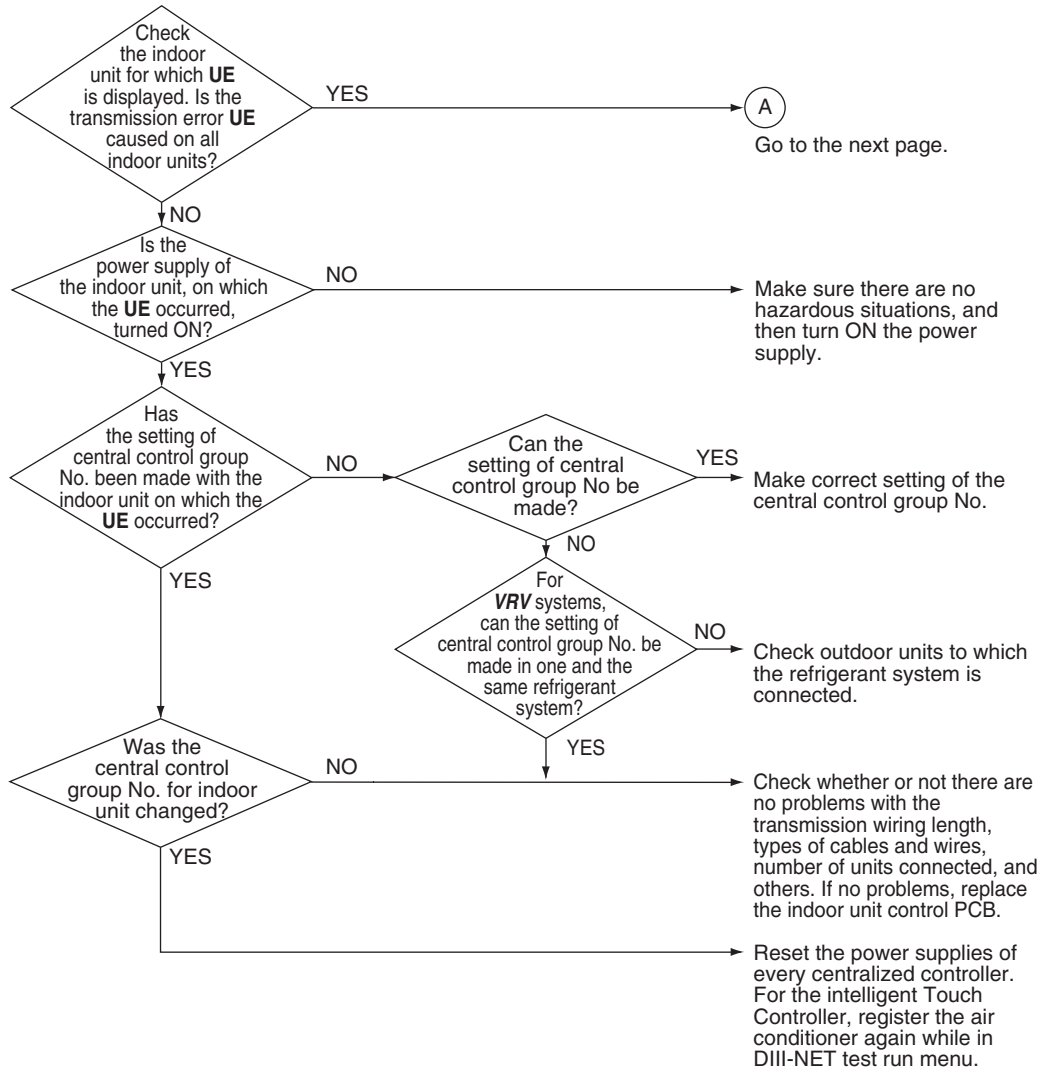

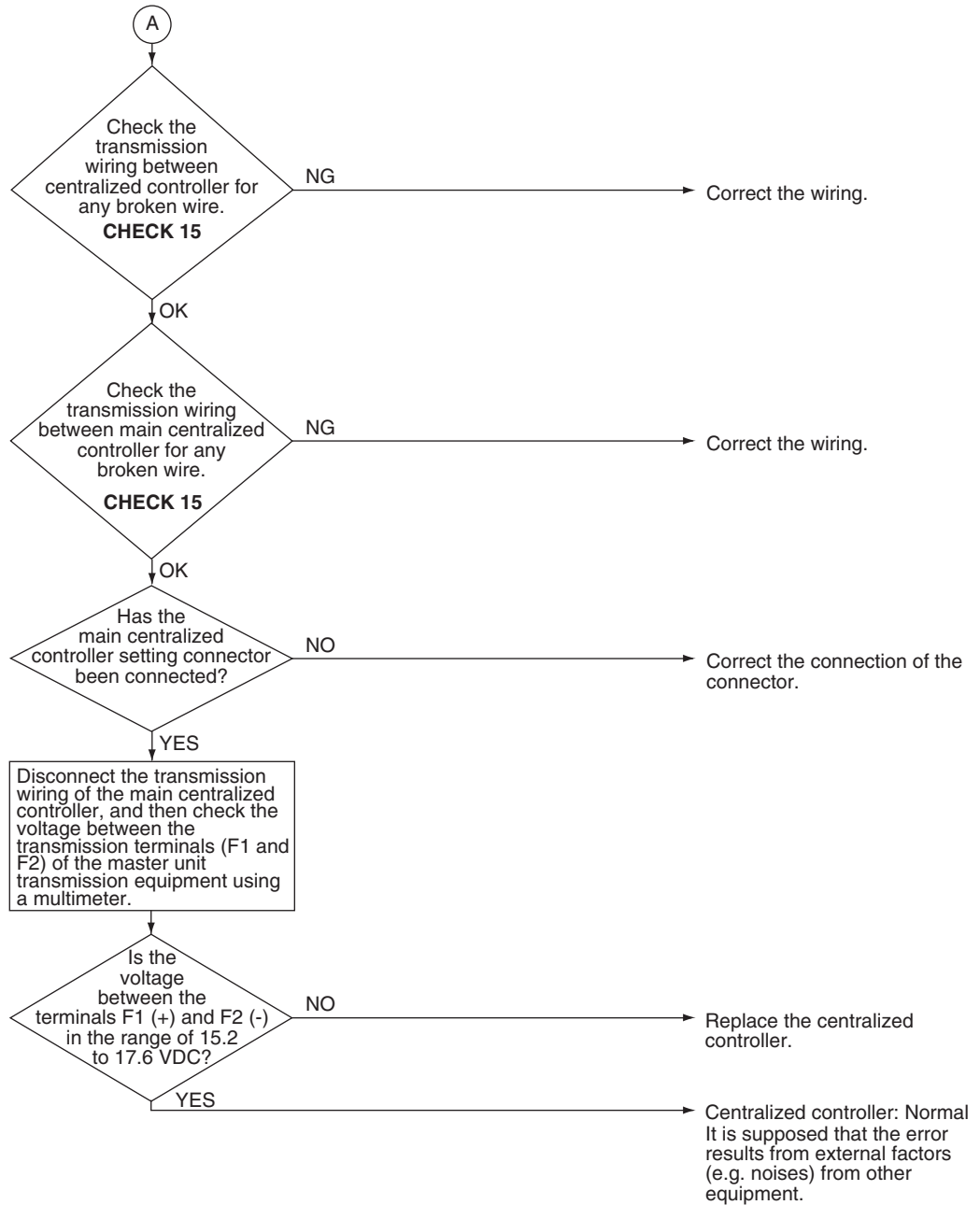

Reference

CHECK 15 Refer to page 464.

## 3.78 System Not Set Yet

<b>Applicable Models</b>	All indoor unit models All outdoor unit models
<b>Error Code</b>	<b>UF</b> Except on wrong wiring detection operation. During wrong wiring detection operation, refer to page 255.
<b>Method of Error Detection</b>	On check operation, the number of indoor units in terms of transmission is not corresponding to that of indoor units that have made changes in temperature.
<b>Error Decision Conditions</b>	The error is determined as soon as the abnormality aforementioned is detected through checking the system for any erroneous connection of units on the check operation.
<b>Supposed Causes</b>	<ul style="list-style-type: none"> <li>■ Improper connection of transmission wiring between indoor-outdoor units and outdoor-outdoor units</li> <li>■ Failure to execute check operation</li> <li>■ Defective indoor unit PCB</li> <li>■ Stop valve is not opened</li> </ul>

### Troubleshooting

**Caution**

Be sure to turn off the power switch before connecting or disconnecting connectors, or parts may be damaged.

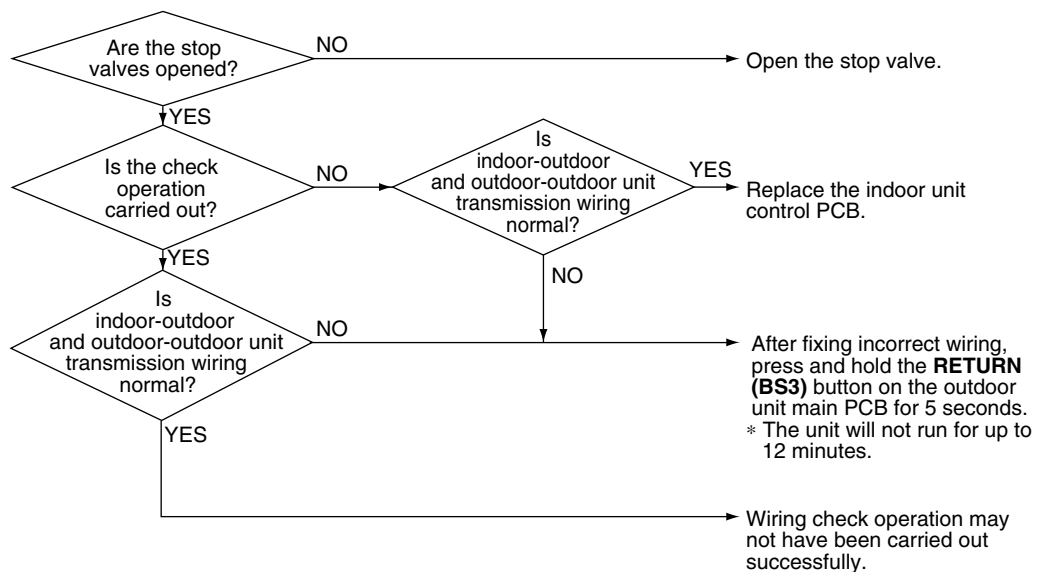

### 3.79 System Abnormality, Refrigerant System Address Undefined

---

<b>Applicable Models</b>	All indoor unit models All outdoor unit models
<b>Error Code</b>	<b>UH</b>
<b>Method of Error Detection</b>	System detects an indoor unit whose address is not defined by automatic address function. *Automatic address refers to the automatic designated address of indoor unit and outdoor unit when connected to the power after installation or wiring replacement (with the <b>RETURN (BS3)</b> button pressed for more than 5 seconds).
<b>Error Decision Conditions</b>	The error decision is made as soon as the abnormality aforementioned is detected.
<b>Supposed Causes</b>	<ul style="list-style-type: none"> <li>■ Improper connection of transmission wiring between indoor-outdoor units and outdoor-outdoor units</li> <li>■ Defective indoor unit PCB</li> <li>■ Defective outdoor unit main PCB (A1P)</li> </ul>

---



Troubleshooting



**Caution** Be sure to turn off the power switch before connecting or disconnecting connectors, or parts may be damaged.

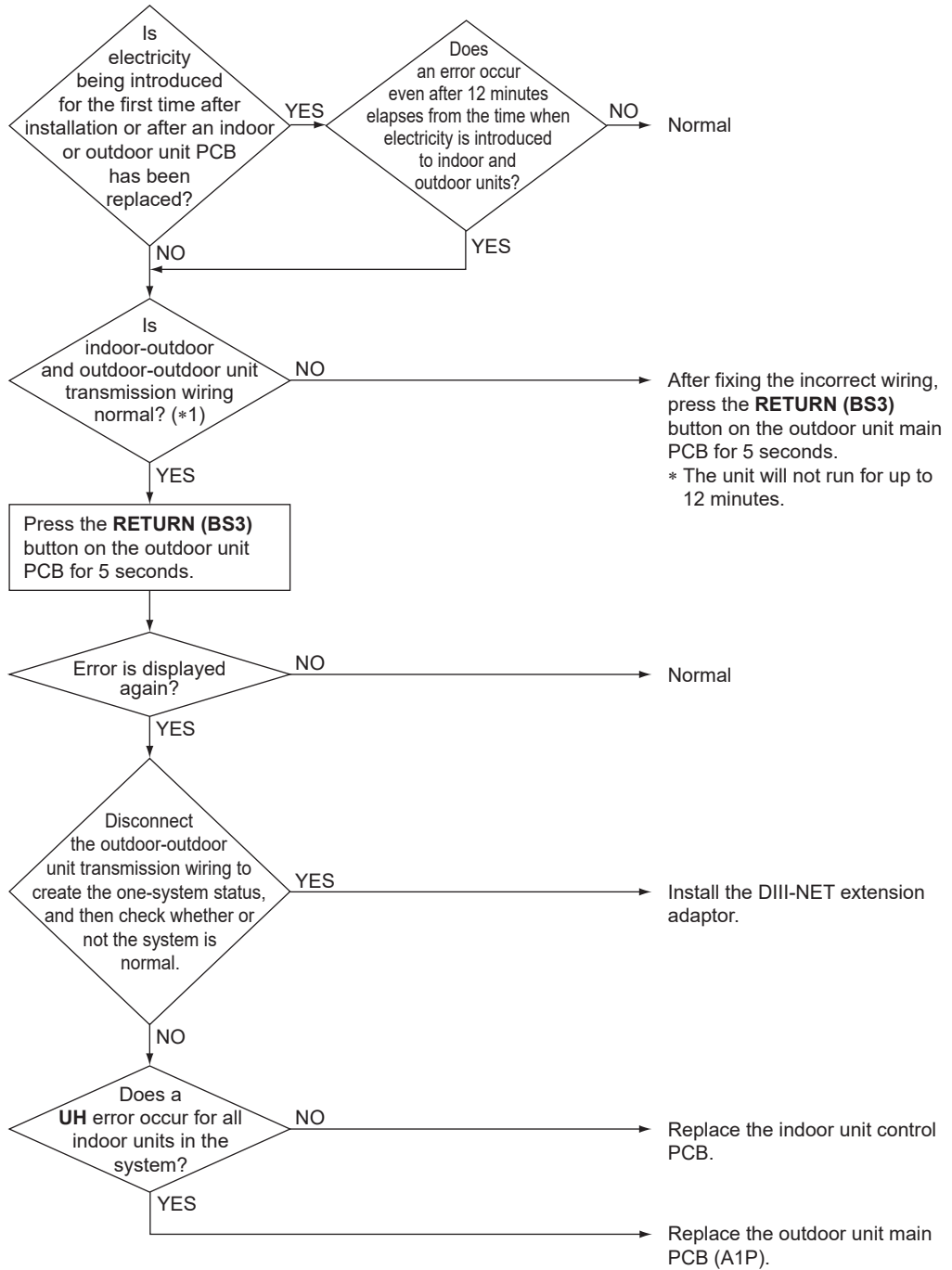

### 3.80 Climate Talk Communication System Combination Error (Before Initial Setting for Communication Completes)

<b>Applicable Models</b>	CXTQ-TA
<b>Error Code</b>	<b>UH-05</b>
<b>Method of Error Detection</b>	Detects the type of the devices constituted in Climate Talk Communication.
<b>Error Decision Conditions</b>	<p>The error decision is made when any of the following conditions is established before elapsing 4 minutes after the power is turned ON.</p> <ul style="list-style-type: none"> <li>■ Two or more gas furnaces are detected.</li> <li>■ Any unit other than the gas furnace is detected.</li> <li>■ The initial setting for communication does not complete.</li> </ul>
<b>Supposed Causes</b>	<ul style="list-style-type: none"> <li>■ Connection of wrong devices</li> <li>■ The power of the gas furnace is not turned ON, or the power of the gas furnace is turned ON after a certain period of time has been elapsed after the power of the CXTQ-TA was turned ON.</li> <li>■ Disconnection of the communication wire between the CXTQ-TA and the gas furnace</li> <li>■ Two or more gas furnaces are connected to one CXTQ-TA.</li> <li>■ No gas furnace is connected.</li> </ul>

**Troubleshooting**

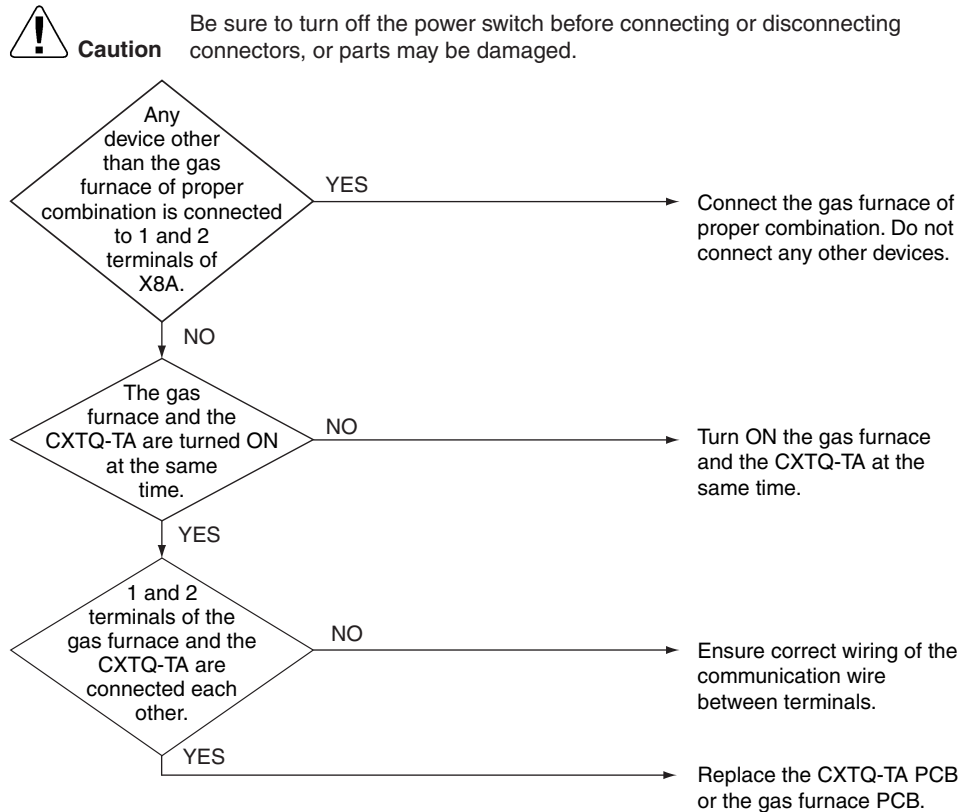

## 3.81 Climate Talk Communication System Combination Error (After Initial Setting for Communication Completes)

### Applicable Models

CXTQ-TA

### Error Code

**UH-06**

### Method of Error Detection

Detects the type of the devices constituted in Climate Talk Communication.

### Error Decision Conditions

The error decision is made when any of the following conditions is established once the initial setting for communication with the gas furnace completes and after elapsing 4 minutes after the power is turned ON.

- Two or more gas furnaces are detected.
- Any unit other than the gas furnace is detected.

### Supposed Causes

- Connection of wrong devices
- Two or more gas furnaces are connected to one CXTQ-TA.

### Troubleshooting



#### Caution

Be sure to turn off the power switch before connecting or disconnecting connectors, or parts may be damaged.

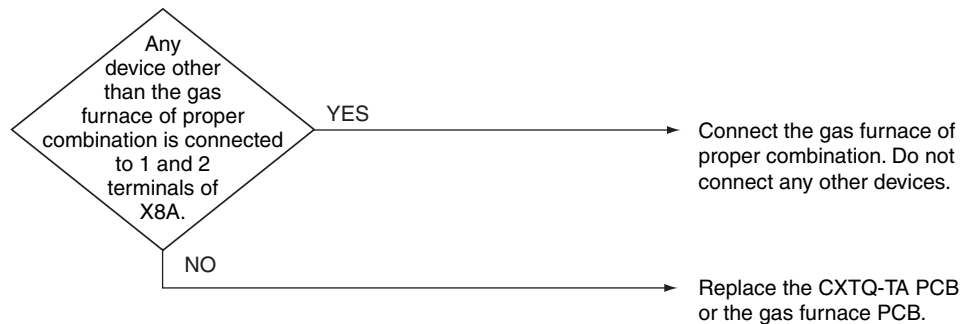

# 4. Check

## 4.1 High Pressure Check

### CHECK 1

Referring to the Fault Tree Analysis (FTA) shown below, probe the defective points.

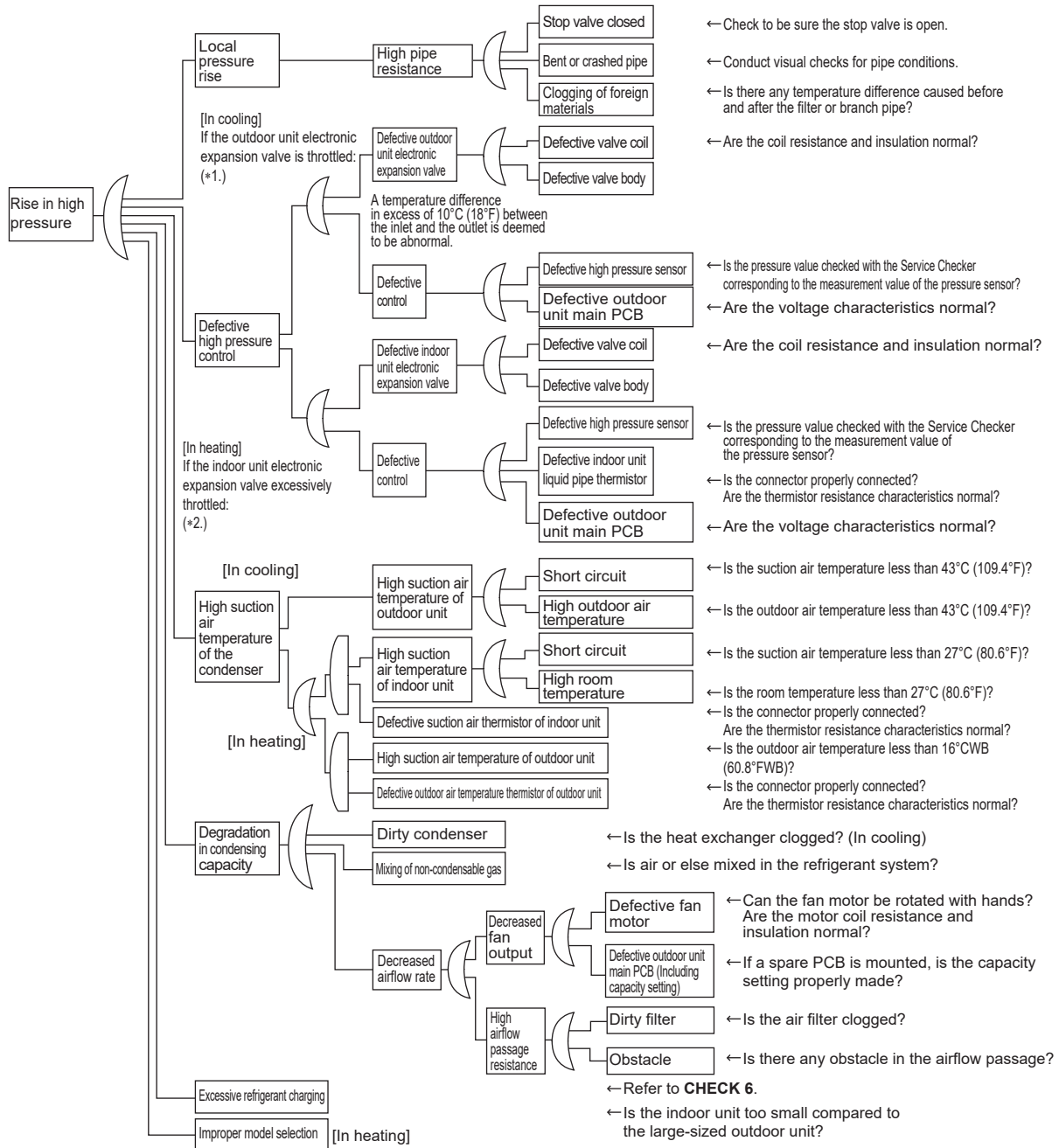

**Note(s)**

- \*1. In cooling, it is normal if the outdoor unit electronic expansion valve (main) is fully open.
- \*2. In heating, the indoor unit electronic expansion valve is used for subcooling degree control.

**Reference**

**CHECK 6** Refer to page 456.

## 4.2 Low Pressure Check

### CHECK 2

Referring to the Fault Tree Analysis (FTA) shown below, probe the defective points

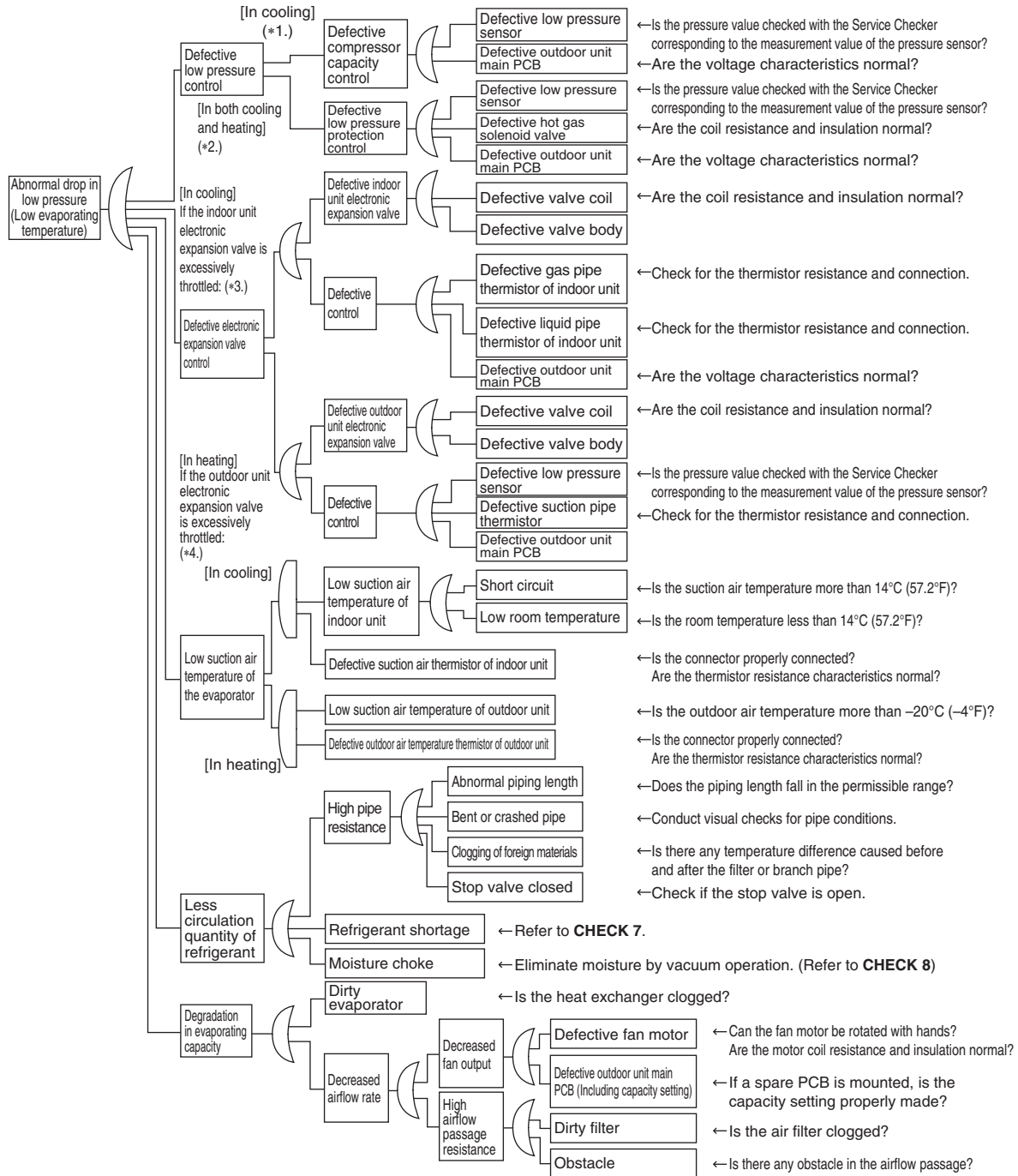

**i** Note(s)

- \*1. For details of compressor capacity control while in cooling, refer to Compressor PI control.
- \*2. The low pressure protection control includes low pressure protection control and hot gas bypass control.
- \*3. In cooling, the indoor unit electronic expansion valve is used for superheating degree control.
- \*4. In heating, the outdoor unit electronic expansion valve (main) is used for superheating degree control of outdoor heat exchanger.



**Reference**    **CHECK 7** Refer to page 457.



**Reference**    **CHECK 8** Refer to page 458.

# 4.3 Superheat Operation Check

## CHECK 3

Referring to the Fault Tree Analysis (FTA) shown below, probe the defective points

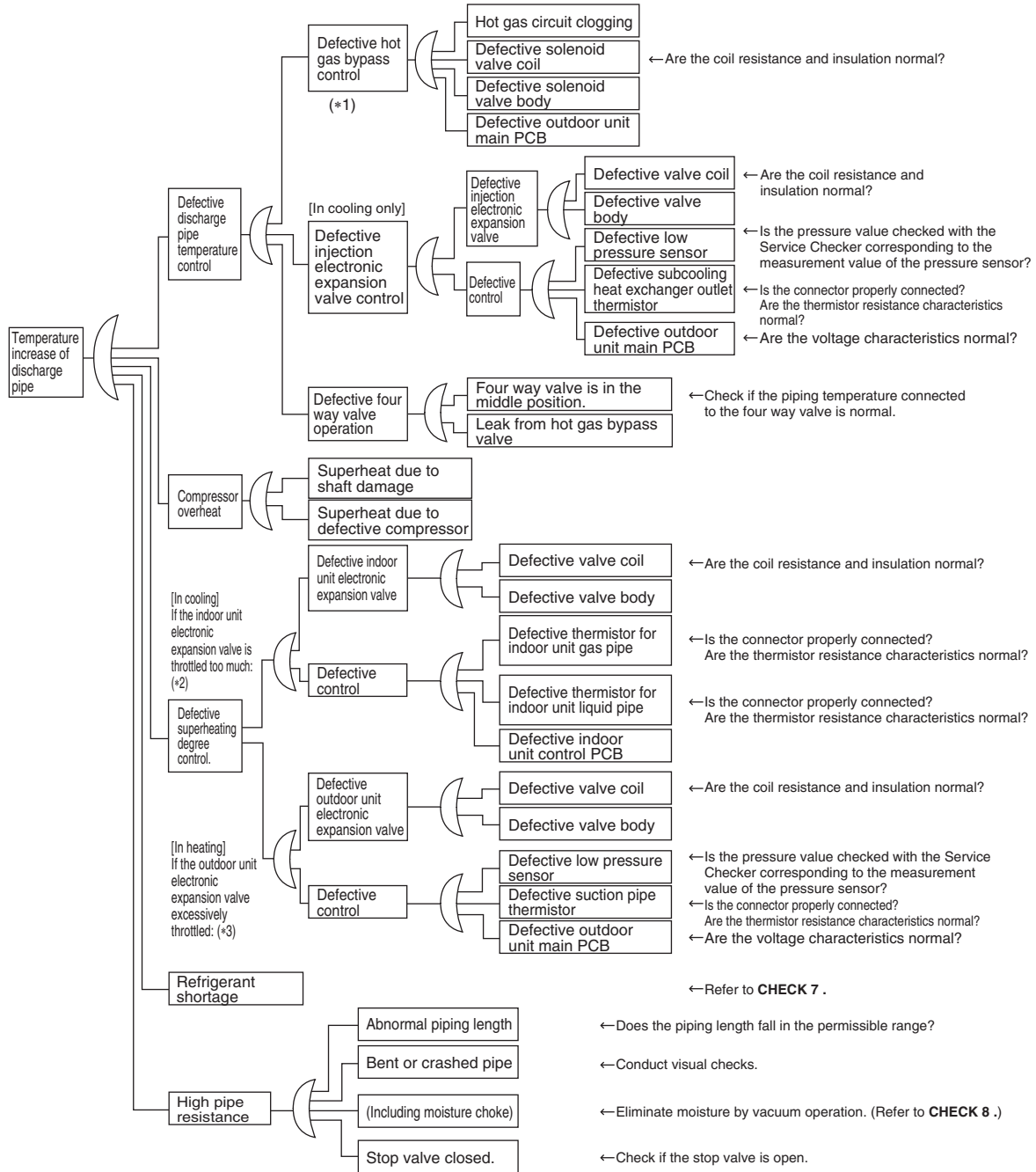

**i** Note(s)

- \*1. Refer to Low pressure protection control for hot gas bypass control.
- \*2. Superheating temperature control in cooling is conducted by indoor unit electronic expansion valve.
- \*3. Superheating temperature control in heating is conducted by outdoor unit electronic expansion valve (main).

- \*4. Judgment criteria of superheat operation:  
(1) Suction gas superheating degree: 10°C (18°F) and over. (2) Discharge gas superheating degree: 45°C (81°F) and over, except immediately after compressor starts up or is running under dropping control.  
(Use the above values as a guide. Depending on the other conditions, the unit may be normal despite the values within the above range.)



**Reference**    **CHECK 7** Refer to page 457.



**Reference**    **CHECK 8** Refer to page 458.



# 4.4 Power Transistor Check

## CHECK 4

Perform the following procedures prior to check.

- (1) Power OFF.
- (2) Remove all the wiring connected to the PCB where power transistors are mounted on.

### Preparation

- Multimeter

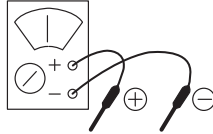

\* Prepare the analog type of multimeter.  
For the digital type of multimeter, those with diode check function are available for the checking.

### Point of Measurement and Judgment Criteria

- Turn OFF the power supply. Then, after a lapse of 10 minutes or more, make measurement of resistance.

No.	Measuring point		When using the analog type of multimeter, make measurement in resistance measurement mode in the x1 kΩ range.	Remarks	When using the digital type of multimeter, make measurement in diode check mode (→ ←).	Remarks
	+	-	Judgement Criteria		Judgement Criteria	
1	P2	U	50 kΩ ~ 500 kΩ	—	OL	Due to condenser charge and so on, resistance measurement may require some time.
2	P2	V				
3	P2	W				
4	U	P2	50 kΩ and more (including ∞)	Due to condenser charge and so on, resistance measurement may require some time.	0.3 ~ 0.7 V	—
5	V	P2				
6	W	P2				
7	N31	U				
8	N31	V				
9	N31	W	50 kΩ ~ 500 kΩ	—	OL	Due to condenser charge and so on, resistance measurement may require some time.
10	U	N31				
11	V	N31				
12	W	N31				

### PCB and Circuit Diagram

- REYQ96/120AATJ\* (M1C, M2C), REYQ144/168AATJ\* (M1C)

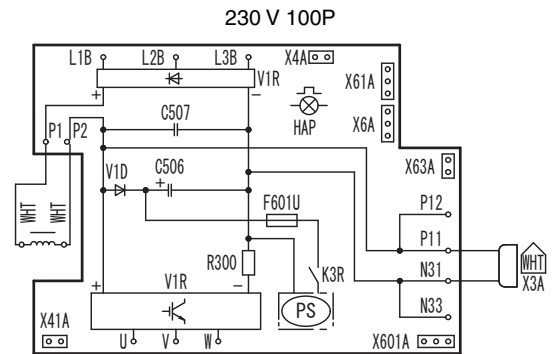
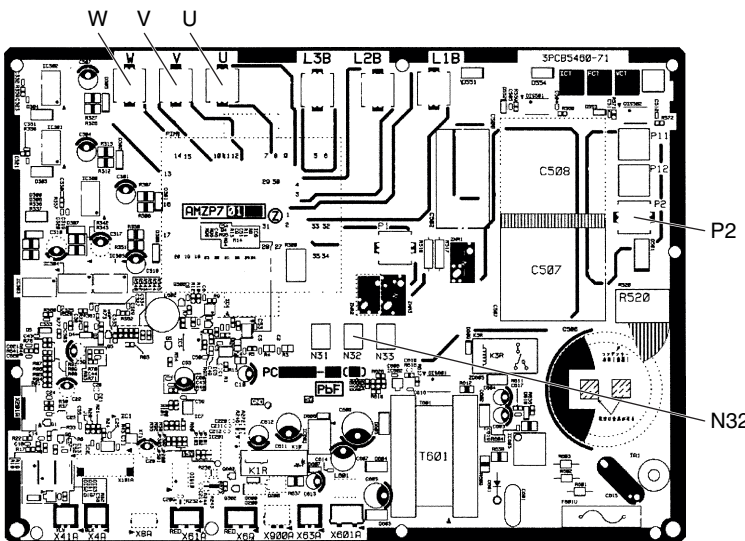

■ REYQ72AATJ\*, REYQ144/168AATJ\* (M2C), REYQ192/216/240AATJ\* (M1C, M2C)

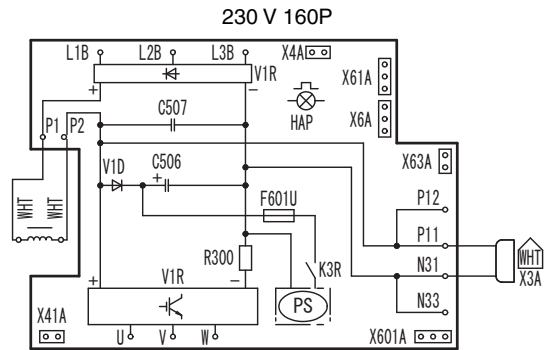
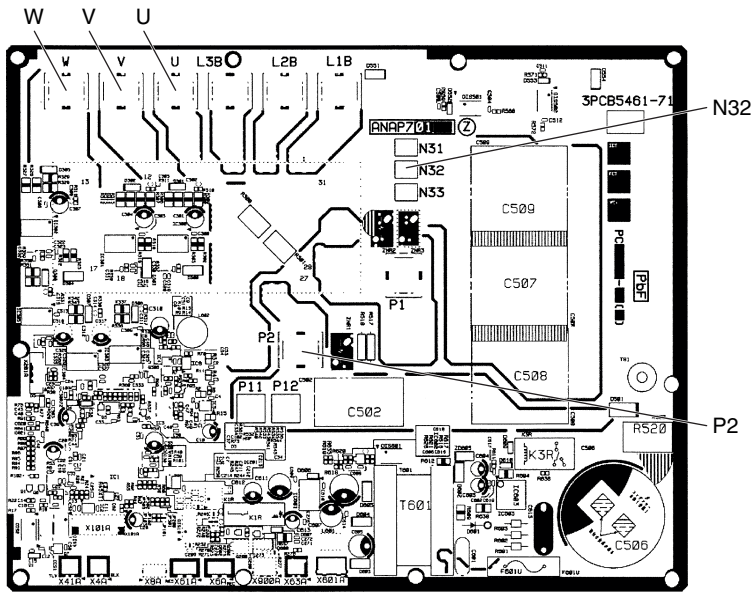

■ REYQ-AAJD\*

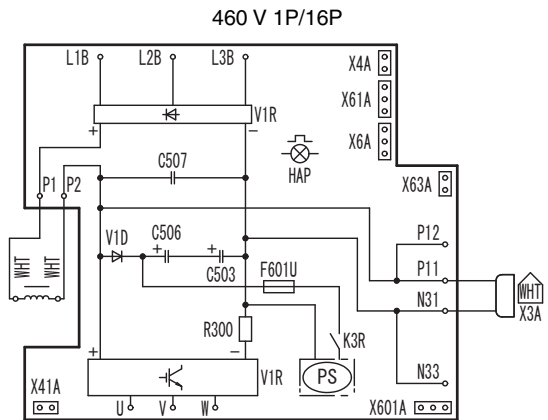
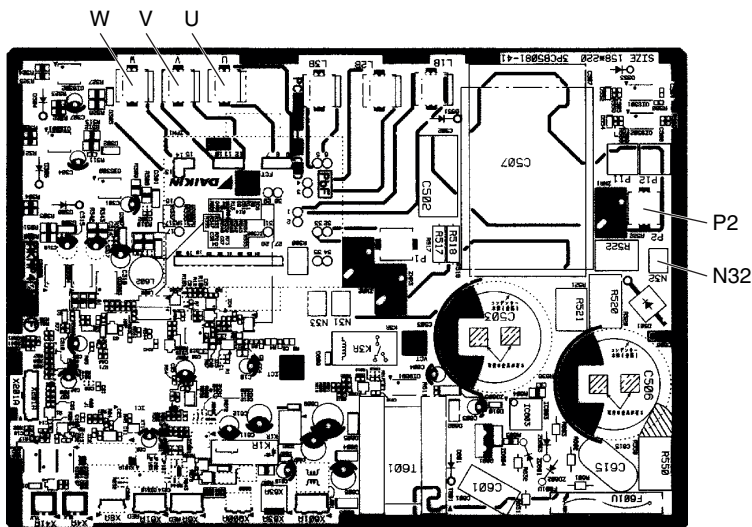

## 4.5 Refrigerant Overcharge Check

### CHECK 6

In case of **VRV** Systems, the only way to judge as the overcharge of refrigerant is with operating conditions due to the relationship to pressure control and electronic expansion valve control. As information for making a judgment, refer to the information below.

#### Diagnosis of refrigerant overcharge

1. High pressure rises. Consequently, overload control is conducted to cause insufficient cooling capacity.
2. The superheating degree of suction gas lowers (or wet operation is performed). Consequently, the compressor becomes lower in discharge pipe temperature despite of pressure loads.
3. The subcooling degree of condensate rises. Consequently, in heating, the temperature of discharge air through the subcooled section becomes lower.

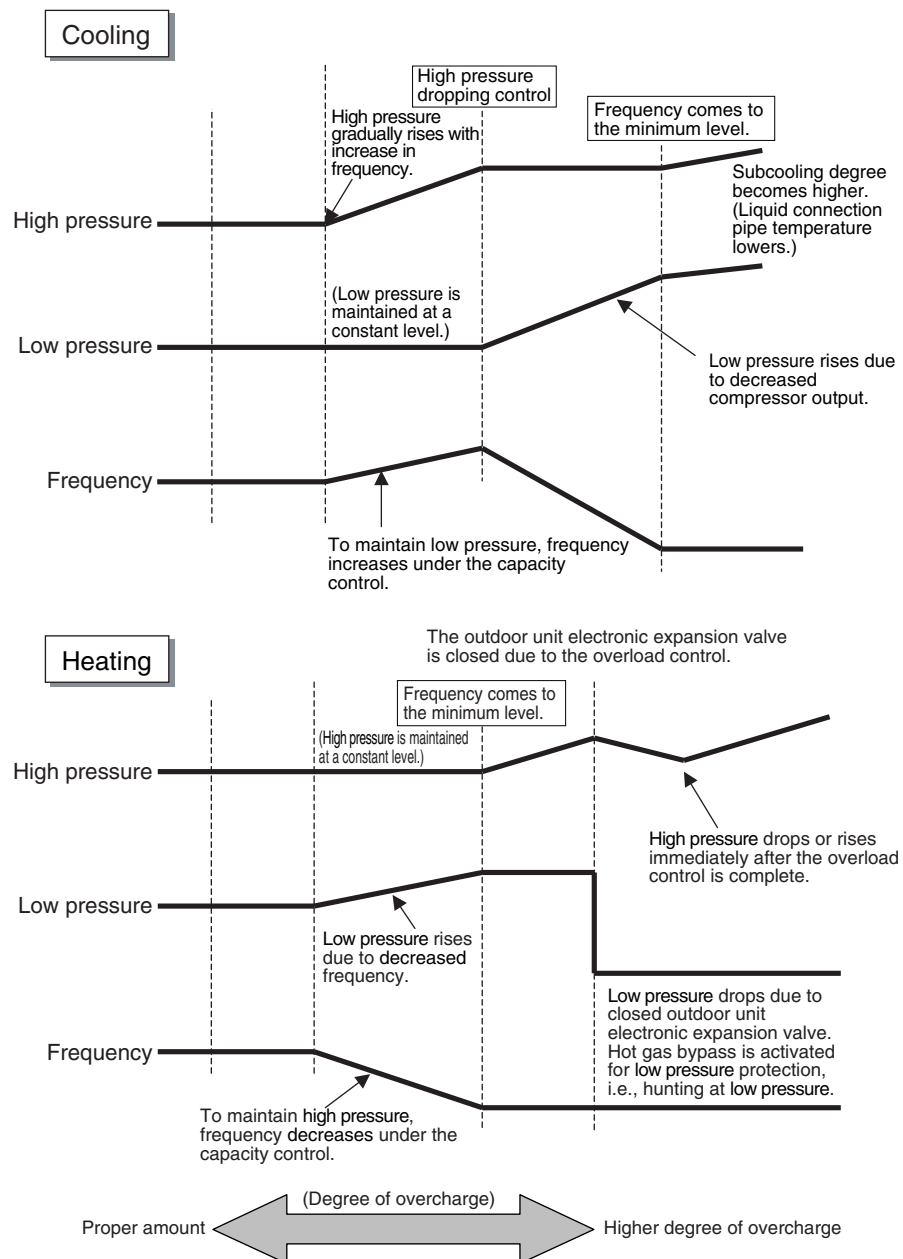

## 4.6 Refrigerant Shortage Check

### CHECK 7

In case of **VRV** Systems, the only way to judge as the shortage of refrigerant is with operating conditions due to the relationship to pressure control and electronic expansion valve control. As information for making a judgement, refer to the information below.

#### Diagnosis of shortage of refrigerant

1. The superheating degree of suction gas rises. Consequently, the compressor discharge gas temperature becomes higher.
2. The superheating degree of suction gas rises. Consequently, the electronic expansion valve turns open.
3. Low pressure drops to cause the unit not to demonstrate cooling/heating capacity.

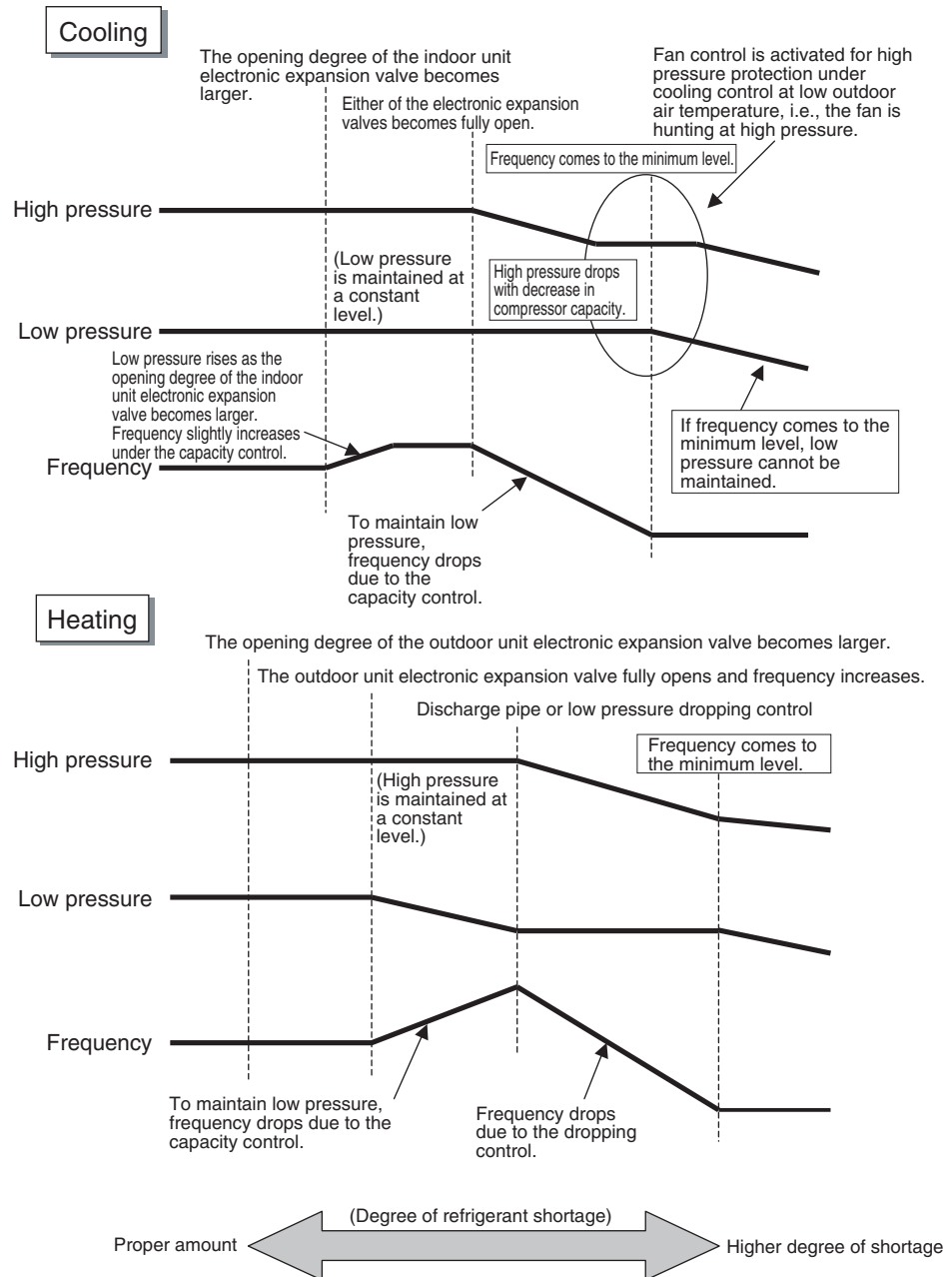

## 4.7 Vacuuming and Dehydration Procedure

---

### CHECK 8

Conduct vacuuming and dehydration in the piping system following the procedure for Normal vacuuming and dehydration described below.

Furthermore, if moisture may get mixed in the piping system, follow the procedure for Special vacuuming and dehydration described below.

#### Normal vacuuming and dehydration

1. Vacuuming and dehydration
  - Use a vacuum pump that enables vacuuming up to 500 microns.
  - Connect manifold gauges to the service ports of liquid pipe and gas pipe and run the vacuum pump for a period of 2 or more hours to conduct evacuation to 500 microns.
  - If the degree of vacuum does not reach 500 microns or less even though evacuation is conducted for a period of 2 hours, moisture will have entered the system or refrigerant leakage will have been caused. In this case, conduct evacuation for a period of another 1 hour.
  - If the degree of vacuum does not reach 500 microns or less even though evacuation is conducted for a period of 3 hours, conduct the leak tests.
2. Leaving in vacuum state
  - Leave the compressor at the degree of vacuum of 500 microns or less for a period of 1 hour or more, and then check to be sure that the vacuum gauge reading does not rise. (If the reading rises, moisture may have remained in the system or refrigerant leakage may have been caused.)
3. Additional refrigerant charge
  - Purge air from the manifold gauge connection hoses, and then charge a necessary amount of refrigerant.

#### Special vacuuming and dehydration

Use this procedure if moisture may get into the piping, such as construction during the rainy season (dew condensation may occur, or rainwater may enter the piping during construction work).

1. Vacuuming and dehydration
  - Follow the same procedure as that for normal vacuuming and dehydration described above.
2. Vacuum break
  - Pressurize with nitrogen gas up to 375,000 microns.
3. Vacuuming and dehydration
  - Conduct vacuuming and dehydration for a period of 1 hour or more. If the degree of vacuum does not reach 500 microns or less even though evacuation is conducted for a period of 2 hours or more, repeat vacuum break - vacuuming and dehydration.
4. Leaving in vacuum state
  - Leave the compressor at the degree of vacuum of 500 microns or less for a period of 1 hour or more, and then check to be sure that the vacuum gauge reading does not rise.
5. Additional refrigerant charge
  - Purge air from the manifold gauge connection hoses, and then charge a necessary amount of refrigerant.

## 4.8 Thermistor Check

### CHECK 11

#### Thermistor type of indoor units

Model	Suction air thermistor	Indoor heat exchanger (liquid) thermistor	Indoor heat exchanger (gas) thermistor	Discharge air thermistor		
	R1T	R2T	R3T	R4T		
FXFQ-AA	Type C	Type A	Type A	—		
FXFQ-T			Type J	—		
FXZQ-TA	Type B		Type A	—	—	
FXZQ-TB				—	—	
FXUQ-P	Type C			—	—	
FXUQ-PA				—	—	
FXEQ-P	Type B		Type J	—	—	
FXDQ-M			—	—		
FXSQ-TA			—	—		
FXSQ-TB			—	—		
FXMQ-PB			—	Type J	Type J	
FXMQ-TB			—	Type A	—	
FXMQ-TA			—	Type J	—	—
FXMQ-M			—		—	—
FXHQ-M			—		—	—
FXAQ-P			—		—	—
FXLQ-M			—		—	—
FXNQ-M			—		—	—
FXTQ-TA			—	Type A	—	—
FXTQ-TB			—		—	—
CXTQ-TA	—	—	—			
FXMQ-MF	Type B	—	Type J	Type J		

**Thermistor type of outdoor units**

Thermistor		Thermistor type
R1T	Outdoor air thermistor	Type N
R2T	Heat exchanger right upper gas pipe thermistor	Type A
R3T	Electrical box air outlet thermistor	
R4T	Receiver gas purge thermistor	
R5T	Suction pipe before accumulator thermistor	
R6T	Heat exchanger right upper liquid pipe thermistor	
R7T	Heat exchanger right lower liquid pipe thermistor	
R8T	Heat exchanger right deicer thermistor	
R9T	Heat exchanger right lower gas pipe thermistor	
R10T	Receiver inlet thermistor	
R11T	Subcooling heat exchanger liquid pipe thermistor	
R12T	Subcooling heat exchanger gas pipe thermistor	
R14T	Subcooling injection thermistor	Type H
R15T	M1C discharge pipe thermistor for REYQ96-240 type	
R16T	M1C body thermistor for REYQ96-240 type	
R17T	M1C discharge pipe thermistor for REYQ72 type M2C discharge pipe thermistor for REYQ96-240 type	
R18T	M1C body thermistor for REYQ72 type M2C body thermistor for REYQ96-240 type	Type A
R19T	Compressor suction thermistor	
R20T	Box air thermistor	
R21T	Heat exchanger left gas pipe thermistor	
R22T	Heat exchanger left liquid pipe thermistor	
R23T	Heat exchanger left deicer thermistor	

Thermistor temperature		Resistance (k $\Omega$ )		
(°C)	(°F)	Type A	Type B	Type C
-30	-22	363.8	—	—
-25	-13	266.8	—	—
-20	-4	197.8	—	—
-15	5	148.2	—	—
-10	14	112.0	111.1	111.8
-5	23	85.52	84.95	85.42
0	32	65.84	65.53	65.80
5	41	51.05	50.95	51.07
10	50	39.91	39.92	39.97
15	59	31.44	31.50	31.51
20	68	24.95	25.02	25.02
25	77	19.94	20.00	20.00
30	86	16.04	16.10	16.10
35	95	12.99	13.04	13.04
40	104	10.58	10.63	10.63
45	113	8.669	8.720	8.711
50	122	7.143	7.189	7.179
55	131	5.918	—	—
60	140	4.928	—	—
65	149	4.123	—	—
70	158	3.467	—	—
75	167	—	—	—
80	176	—	—	—
85	185	—	—	—
90	194	—	—	—
95	203	—	—	—
100	212	—	—	—
105	221	—	—	—
Drawing No.		3SA48002 3SA48018 3SA48019 (AD94A045) 3SA48013 (AD100026)	3SA48001 (AD210486)	3SA48016 (AD100008) 3SA480014 (AD150384)

\*This data is for reference purposes only.



Thermistor temperature		Resistance (k $\Omega$ )		
(°C)	(°F)	Type H	Type J	Type N
-30	-22	3407	352.1	363.4
-25	-13	2540	261.2	266.7
-20	-4	1910	195.4	197.8
-15	5	1449	147.3	148.2
-10	14	1108	111.8	112.1
-5	23	853.8	85.49	85.51
0	32	662.7	65.80	65.80
5	41	517.9	51.15	51.11
10	50	407.4	40.08	40.01
15	59	322.5	31.64	31.54
20	68	256.9	25.16	25.04
25	77	205.7	20.14	20.00
30	86	165.7	16.23	16.09
35	95	134.3	13.16	13.02
40	104	109.4	10.73	10.60
45	113	89.58	8.800	8.685
50	122	73.73	7.255	7.153
55	131	60.98	6.012	5.923
60	140	50.67	5.010	4.929
65	149	42.29	4.196	4.122
70	158	35.45	3.532	3.463
75	167	29.84	2.987	—
80	176	25.21	2.538	—
85	185	21.38	2.166	—
90	194	18.21	1.857	—
95	203	15.57	1.598	—
100	212	13.36	1.380	—
105	221	11.49	1.196	—
110	230	9.92	1.041	—
115	239	8.594	0.908	—
120	248	7.465	0.795	—
125	257	6.499	0.698	—
130	266	5.675	0.615	—
135	275	4.968	0.543	—
140	284	4.360	0.481	—
145	293	3.836	0.428	—
150	302	3.384	0.381	—
Drawing No.		3SA48006 (AD190115)	3SA48005 (AD190114)	3S480024 (AD180053)

\*This data is for reference purposes only.

# 4.9 Pressure Sensor Check

## CHECK 12

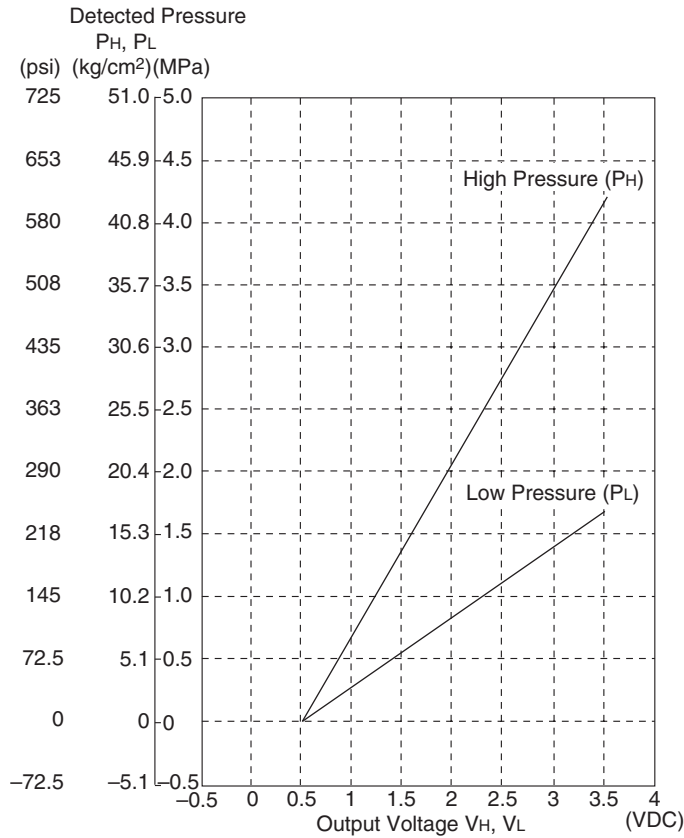

$$P_H \text{ (MPa)} = \frac{4.15}{3.0} \times V_H - \frac{4.15}{3.0} \times 0.5$$

$$P_L \text{ (MPa)} = \frac{1.7}{3.0} \times V_L - \frac{1.7}{3.0} \times 0.5$$

1 MPa = 145 psi

$P_H$  : High pressure (MPa)

$P_L$  : Low pressure (MPa)

$V_H$  : Output Voltage (High Side) (VDC)

$V_L$  : Output Voltage (Low Side) (VDC)

### Voltage Measurement Point of the High Pressure Sensor

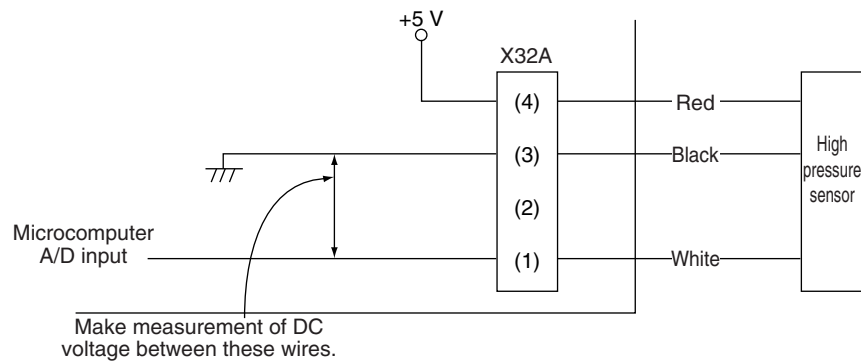

### Voltage Measurement Point of the Low Pressure Sensor

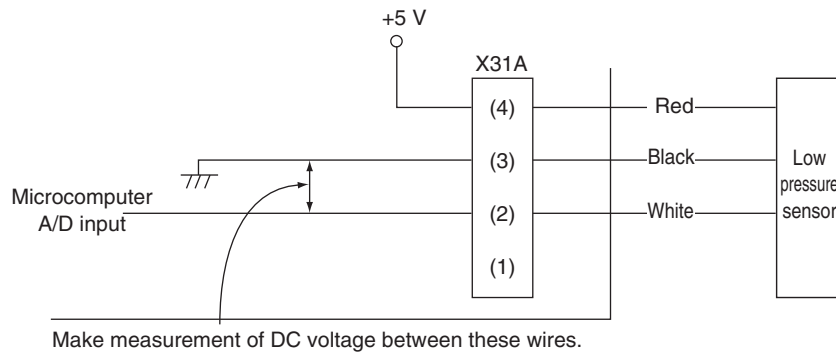

## 4.10 Broken Wire Check of the Relay Wires

---

### CHECK 15

1. Procedure for checking outdoor-outdoor unit transmission wiring for broken wires  
On the system shown below, turn OFF the power supply to all equipment, short circuit between the outdoor-outdoor unit terminal F1 and F2 in the outdoor unit **A** that is farthest from the central remote controller, and then conduct continuity checks between the transmission wiring terminal blocks F1 and F2 of the central remote controller using a multimeter. If there is continuity between the said terminal blocks, the outdoor-outdoor unit transmission wiring has no broken wires in it.  
If there is no continuity, the transmission wiring may have broken wires. With the outdoor-outdoor unit terminal of the outdoor unit **A** short circuited, conduct continuity checks between the transmission wiring terminal blocks F1 and F2 of the unified ON/OFF controller. If there is no continuity as well, conduct continuity checks between the outdoor-outdoor unit terminal of the outdoor unit **E**, between the outdoor-outdoor unit terminal of the outdoor unit **D**, between the outdoor-outdoor unit terminal of the outdoor unit **C**, ... in the order described, thus identifying the place with continuity.  
If the place with continuity can be identified, there may be broken wires in places before the said place with continuity.
2. Procedure for checking indoor-outdoor unit transmission wiring for broken wires (for checking the indoor-outdoor unit transmission wiring of the outdoor unit **C** for broken wires)  
Turn OFF the power supply to all equipment, short circuit between the indoor-outdoor unit terminal F1 and F2 in the outdoor unit **C**, and then conduct continuity checks between the transmission wirings F1 and F2 of the indoor unit **a** that is farthest from the outdoor unit **C** using a multimeter. If there is continuity between the said transmission wirings, the indoor-outdoor unit transmission wiring has no broken wires in it.  
If there is no continuity, the transmission wiring may have broken wires. With the indoor-outdoor unit terminal of the outdoor unit **C** short circuited, identify the place with continuity in the transmission wiring of the indoor unit **b**, transmission wiring of the indoor unit **c**, and transmission wiring of the indoor unit **d** in the order described.  
If the place with continuity can be identified, there may be broken wires in places before the said place with continuity.

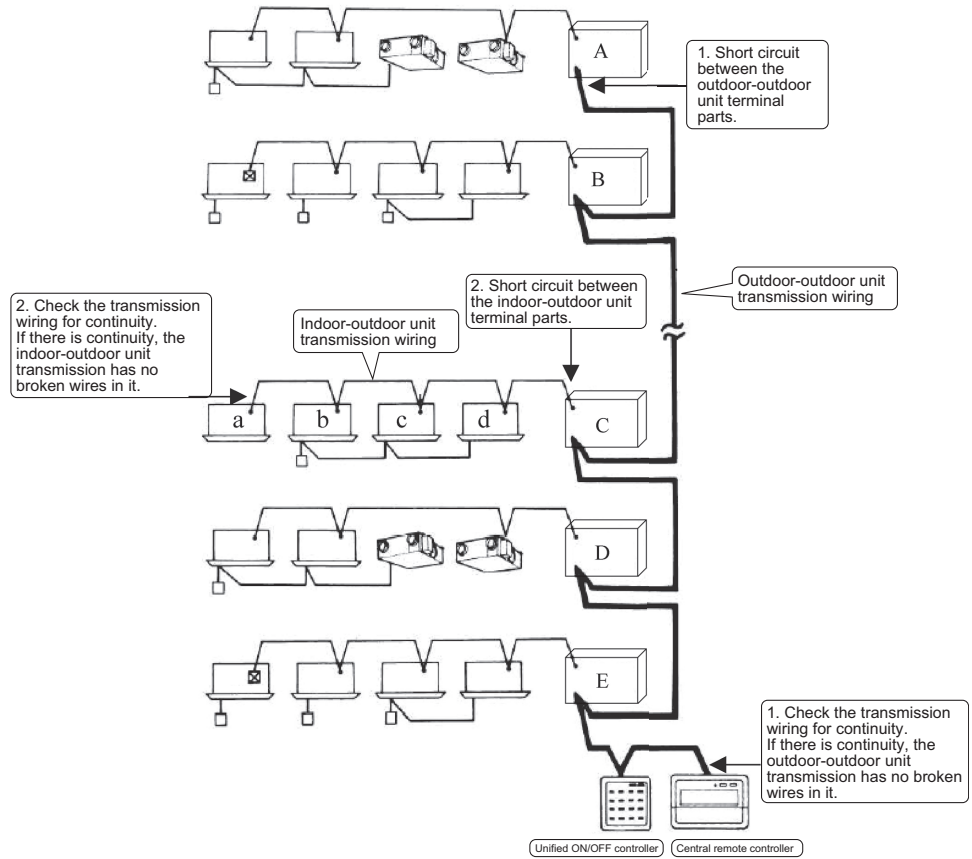

## 4.11 Fan Motor Connector Check (Power Supply Cable)

### CHECK 16

Check the fan motor connector according to the following procedure.

#### Indoor Unit

##### FXFQ-AA

1. Turn the power supply OFF.
2. Disconnect the fan motor connector from the PCB and measure the resistances between U-V, V-W and W-U.

Judgment: Resistances must be balanced within 20%.

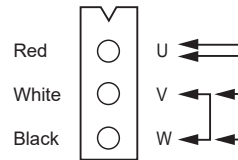

##### FXDQ-M, FXHQ-M

1. Turn OFF the power supply.
2. Measure the resistance between phases of U, V, W at the motor side connectors (3-core wire) to check that the values are balanced and there is no short circuiting, while connector or relay connector is disconnected.

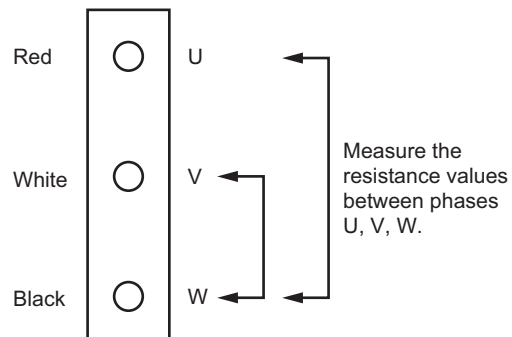

Model	Judgment	
	Black-Red	Black-White
FXDQ07-12M	71.0 $\Omega \pm 10\%$	73.5 $\Omega \pm 10\%$
FXDQ18/24M	39.2 $\Omega \pm 10\%$	41.3 $\Omega \pm 10\%$
FXHQ12M	71.0 $\Omega \pm 10\%$	73.5 $\Omega \pm 10\%$
FXHQ24/36M	53.5 $\Omega \pm 10\%$	31.6 $\Omega \pm 10\%$

##### FXSQ54TA, FXSQ54TB, FXMQ15-54PB, FXMQ30-54TB

Remove the X1A connector from the fan PCB (A2P) and measure the resistance between the U and V, V and W, and W and U phases of the motor connector (with five conductors) and check that each phase are balanced (within a permissible dispersion range of  $\pm 20\%$ ).

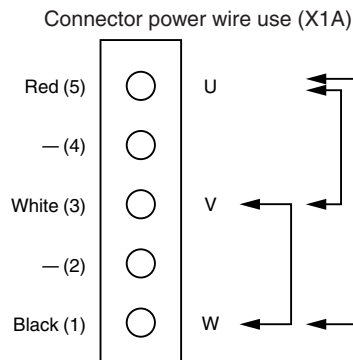

**FXMQ-TA**

Measurement of power wire connector.

Remove the X1A connector from the fan PCB (A2P) and measure the resistance between the U and V, V and W, and W and U phases of the motor connector (with five conductors) and check that each phase are balanced (within a permissible dispersion range of  $\pm 20\%$ )

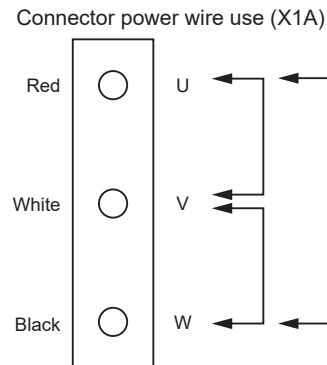
**Outdoor Unit**

1. Turn OFF the power supply.
2. Measure the resistance between phases of U, V, W at the motor side connectors (3-core wire) to check that the values are balanced and there is no short circuiting, while connector or relay connector is disconnected.

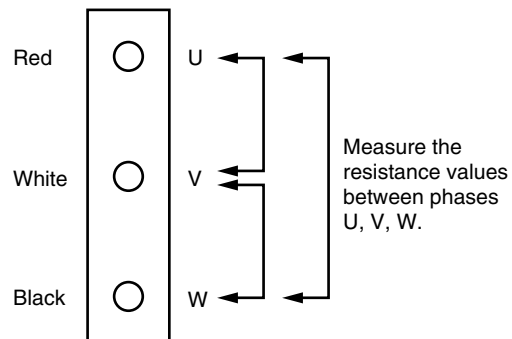

## 4.12 Fan Motor Connector Check (Signal Cable)

**CHECK 17**

Resistance measuring points and judgment criteria.

**Indoor Unit**

**FXFQ-T, FXZQ-TA, FXZQ-TB, FXUQ-P, FXSQ05-48TA, FXSQ05-48TB, FXMQ07-12PB, FXMQ15-24TB, FXAQ-P**

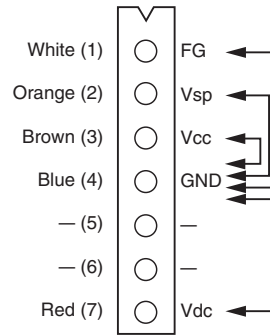

Measuring points	Judgment criteria
1 - 4	1 Ω or more
2 - 4	1 Ω or more
3 - 4	1 Ω or more
7 - 4	1 Ω or more

**FXEQ-P, FXUQ-PA**

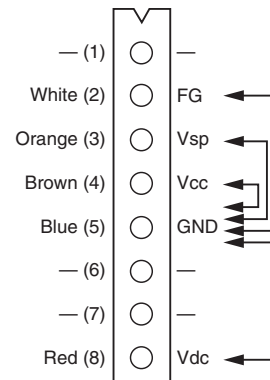

Measuring points	Judgment criteria
2 - 5	1 Ω or more
3 - 5	1 Ω or more
4 - 5	1 Ω or more
8 - 5	1 Ω or more

**FXSQ54TA, FXSQ54TB, FXMQ15-54PB, FXMQ30-54TB**

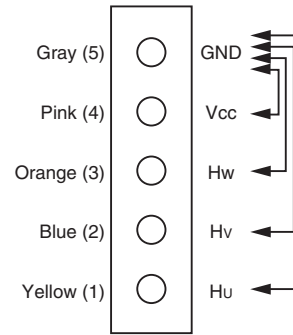

Measuring points	Judgment criteria
5 - 4	1 $\Omega$ or more
5 - 3	1 $\Omega$ or more
5 - 2	1 $\Omega$ or more
5 - 1	1 $\Omega$ or more

**FXMQ-TA**

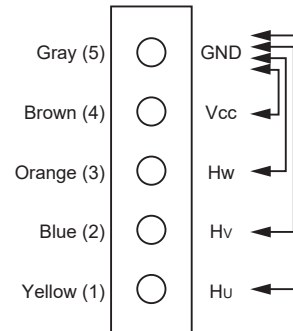

Measuring points	Judgment criteria
5 - 4	1 $\Omega$ or more
5 - 3	1 $\Omega$ or more
5 - 2	1 $\Omega$ or more
5 - 1	1 $\Omega$ or more



## 4.13 Electronic Expansion Valve Coil Check

### CHECK 18

Measure the connector pin-to-pin resistance and make sure that the resistance value is within the range listed in the table below.

Determine the type according to the connector wire color and measure the resistance.

#### Outdoor Unit

#### Y1E, Y2E, Y4E, Y5E, Y3E (REYQ72AA)

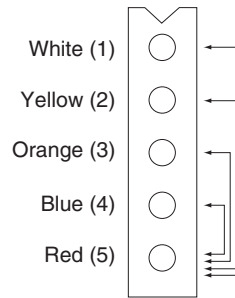

Measuring points	Judgment criteria	
	Y1E, Y2E, Y4E, Y5E	Y3E (REYQ72AA)
1 - 5	120-180 Ω	35-55 Ω
2 - 5		
3 - 5		
4 - 5		

#### Y3E (Except REYQ72AA), Y6E, Y7E, Y8E



Measuring points	Judgment criteria
1 - 5	35-55 Ω
2 - 5	
3 - 5	
4 - 5	

Indoor Unit

**FXFQ-AA, FXFQ-T, FXZQ-TA, FXZQ-TB, FXUQ-P, FXUQ-PA, FXEQ-P, FXSQ-TA, FXSQ-TB, FXMQ-TB, FXTQ-TA, FXTQ-TB, CXTQ-TA**

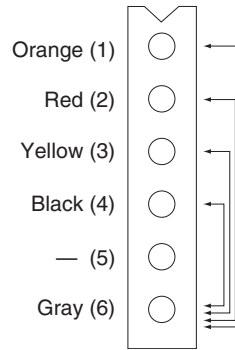

Measuring points	Judgment criteria
1 - 6	35-55 Ω
2 - 6	
3 - 6	
4 - 6	

**FXMQ-PB, FXAQ-P**



Measuring points	Judgment criteria
1 - 3	300 Ω
1 - 5	150 Ω
2 - 4	300 Ω
2 - 6	150 Ω

**FXDQ-M, FXMQ-M, FXHQ-M, FXLQ-M, FXNQ-M, FXMQ-MF**

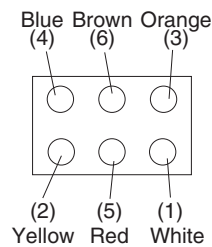

Measuring points	Judgment criteria
1 - 3	300 Ω
1 - 5	150 Ω
2 - 4	300 Ω
2 - 6	150 Ω

FXMQ-TA

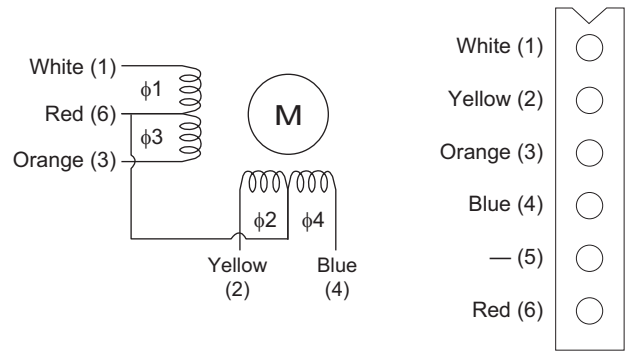

Measuring points	Judgment criteria
1 - 2	No continuity
1 - 3	300 $\Omega$
1 - 6	150 $\Omega$
2 - 4	300 $\Omega$
2 - 6	150 $\Omega$

**Branch Selector unit (EVSC)**

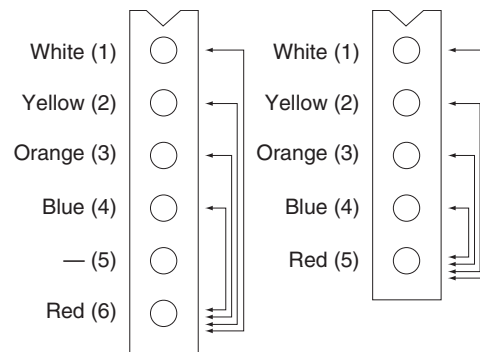
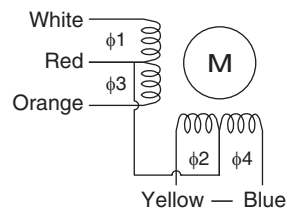

Measuring points	Judgment criteria
White - Red	35-55 Ω
Yellow - Red	
Orange - Red	
Blue - Red	

**Branch Selector unit (EVH, EVL)**

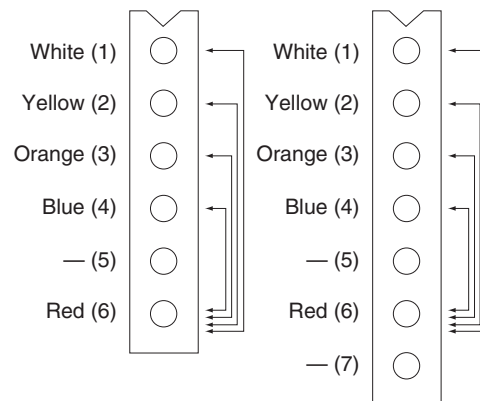
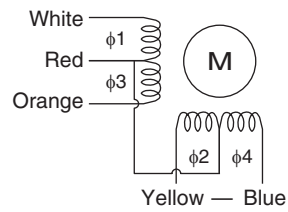

Measuring points	Judgment criteria
White - Red	120-180 Ω
Yellow - Red	
Orange - Red	
Blue - Red	

## 4.14 Fan Motor Connector Check for FXTQ-TA, FXTQ-TB

### CHECK 19

#### CHECKING EMERSON ULTRATECH™ ECM MOTORS

The FXTQ-TA and FXTQ-TB models utilize an Emerson, 4-wire variable speed ECM blower motor. The ECM blower motor provides constant CFM.

The motor is a serially communicating variable speed motor. Only four wires are required to control the motor: +Vdc, Common, Receive, and Transmit.

The +Vdc and Common wires provide power to the motor's low voltage control circuits.

#### General Checks / Considerations

1. Check power supply to the air handler or modular blower. Ensure power supply is within the range specified on rating plate.
2. Check motor power harness. Ensure wires are continuous and make good contact when seated in the connectors. Repair or replace as needed.
3. Check motor control harness. Ensure wires are continuous and make good contact when seated in the connectors. Repair or replace as needed.
4. Check blower wheel. Confirm wheel is properly seated on motor shaft. Set screw must be on shaft flat and torqued to 165 in-lbs minimum. Confirm wheel has no broken or loose blades. Repair or replace as needed.
5. Ensure motor and wheel turn freely. Check for interference between wheel and housing or wheel and motor. Repair or replace as needed.
6. Check housing for cracks and/or corrosion. Repair or replace as needed.
7. Check motor mounting bracket. Ensure mounting bracket is tightly secured to the housing. Ensure bracket is not cracked or broken.

#### Emerson UltraCheck-EZ™ Diagnostic Tool

The Emerson UltraCheck-EZ™ diagnostic tool may be used to diagnose the ECM motor.



#### Warning

#### HIGH VOLTAGE!

Disconnect ALL power before servicing or installing. Multiple power sources may be present. Failure to do so may cause property damage, personal injury or death.

To use the diagnostic tool, perform the following steps:

1. Disconnect power to the air handler.
2. Disconnect the 4-circuit control harness from the motor.
3. Plug the 4-circuit connector from the diagnostic tool into the motor control connector.
4. Connect one alligator clip from the diagnostic tool to a ground source.
5. Connect the other alligator clip to a 24VAC source.  
**NOTE:** The alligator clips are NOT polarized.  
**NOTE:** The Ultra Check-EZ™ diagnostic tool is equipped with a non-replaceable fuse. Connecting the tool to a source other than 24VAC could damage the tool and cause the fuse to open. Doing so will render the diagnostic tool inoperable.
6. Turn on power to air handler or modular blower.



#### Warning

Line Voltage now present.

7. Depress the orange power button on the diagnostic tool to send a run signal to the motor. Allow up to 5 seconds for the motor to start.  
**NOTE:** If the orange power button does not illuminate when depressed, the tool either has an open fuse or is not properly connected to a 24VAC source.

8. The green LED on the diagnostic tool will blink indicating communications between the tool and motor. See table below for indications of tool indicators and motor actions. Replace or repair as needed.

Power Button	Green LED	Motor Action	Indication(s)
OFF	OFF	Not Rotating	Confirm 24VAC to UltraCheck-EZ™ tool. If 24VAC is confirmed, diagnostic tool is inoperable.
ON	Blinking	Rotating	Motor and control/end bell are functioning properly.
ON	OFF	Rotating	Replace motor control/end bell.
ON	Blinking	Not Rotating	Check motor (refer to Motor Checks on page 477).
ON	OFF	Not Rotating	Replace motor control/end bell; verify motor (refer to Motor Checks on page 477).

9. Depress the orange power button to turn off motor.  
 10. Disconnect power. Disconnect diagnostic tool.  
 11. Reconnect the 4-wire harness from control board to motor.

### Electrical Checks - High Voltage Power Circuits



#### Warning

#### HIGH VOLTAGE!

Disconnect ALL power before servicing or installing. Multiple power sources may be present. Failure to do so may cause property damage, personal injury or death.

1. Disconnect power to air handler or modular blower.
2. Disconnect the 5-circuit power connector to the ECM motor.
3. Turn on power to air handler or modular.



#### Warning

Line Voltage now present.

4. Measure voltage between pins 4 and 5 on the 5-circuit connector. Measured voltage should be the same as the supply voltage to the air handler or modular.

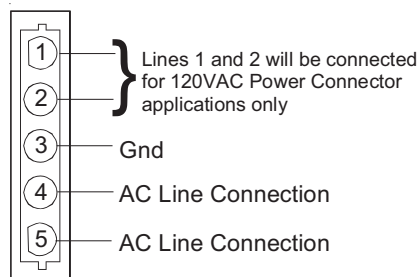

5. Measure voltage between pins 4 and 3. Voltage should be approximately half of the voltage measured in step 4.
6. Measure voltage between pins 5 and 3. Voltage should be approximately half of the voltage measured in step 4.
7. If no voltage is present, check supply voltage to air handler or modular blower.
8. Disconnect power to air handler or modular blower. Reconnect the 5-circuit power harness disconnected in step 2.

### Electrical Checks - Low Voltage Control Circuits

1. Turn on power to air handler or modular.



#### Warning

Line Voltage now present.

2. Check voltage between pins on the 4-wire motor control harness between the motor and control board.
3. Voltage on pins should read:
  - Pins 1 to 4 = 3.3vdc
  - Pins 1 to 2 = 3.3vdc
  - Pins 3 to 4 = 15vdc

### Motor Control/End Bell Checks



#### Warning

HIGH VOLTAGE!

Disconnect ALL power before servicing or installing. Multiple power sources may be present. Failure to do so may cause property damage, personal injury or death.

1. Disconnect power to air handler or modular blower.
 

**NOTE:** Motor contains capacitors that can hold a charge for several minutes after disconnecting power. Wait 5 minutes after removing power to allow capacitors to discharge.
2. Disconnect the motor control harness and motor power harness.
3. Remove the blower assembly from the air handler or modular blower.
4. Remove the (3) screws securing the control/end bell to the motor. Separate the control/end bell. Disconnect the 3-circuit harness from the control/end bell to remove the control/end bell from the motor.
5. Inspect the NTC thermistor inside the control/end bell. Replace control/end bell if thermistor is cracked or broken.

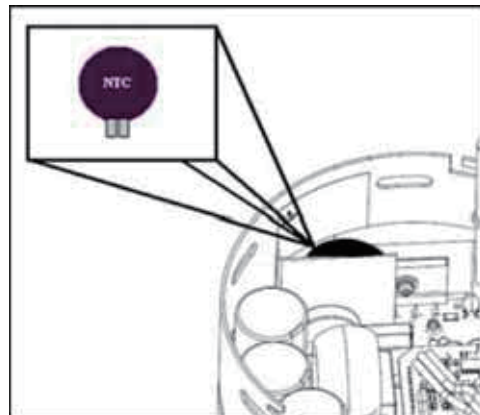

6. Inspect the large capacitors inside the control/end bell. Replace the control/end bell if any of the capacitors are bulging or swollen.

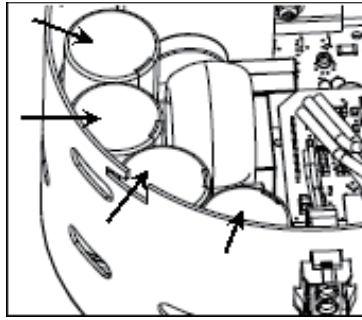

7. Locate the 3-circuit connector in the control/end bell. Using an ohmmeter, check the resistance between each terminal in the connector. If the resistance is 1 MΩ or greater, the control/end bell is functioning properly. Replace the control/end bell if the resistance is lower than 1 MΩ.
8. Reassemble motor and control/end bell in reverse of disassembly. Replace blower assembly into air handler or modular blower.

### Motor Checks



#### Warning

#### HIGH VOLTAGE!

Disconnect ALL power before servicing or installing. Multiple power sources may be present. Failure to do so may cause property damage, personal injury or death.

1. Disconnect power to air handler or modular blower.  
**NOTE:** Motor contains capacitors that can hold a charge for several minutes after disconnecting power. Wait 5 minutes after removing power to allow capacitors to discharge.
2. Disassemble motor as described in steps 2 through 4 above.
3. Locate the 3-circuit harness from the motor. Using an ohmmeter, measure the resistance between each motor phase winding. The resistance levels should be equal. Replace the motor if the resistance levels are unequal, open circuited or short circuited.
4. Measure the resistance between each motor phase winding and the motor shell. Replace the motor if any phase winding is short circuited to the motor shell.
5. Reassemble motor and control/end bell in reverse of disassembly. Replace blower assembly into air handler or modular blower.



# Part 7 Appendix

1. Wiring Diagrams.....	479
1.1 Outdoor Unit.....	479
1.2 Branch Selector Unit .....	481
1.3 Indoor Unit.....	490
1.4 Air Treatment Equipment .....	512
2. Electrical Component Box Removal.....	515

# 1. Wiring Diagrams

## 1.1 Outdoor Unit

REYQ72/96/120/144/168/192/216/240AATJA, REYQ72/96/120/144/168/192/216/240AATJB

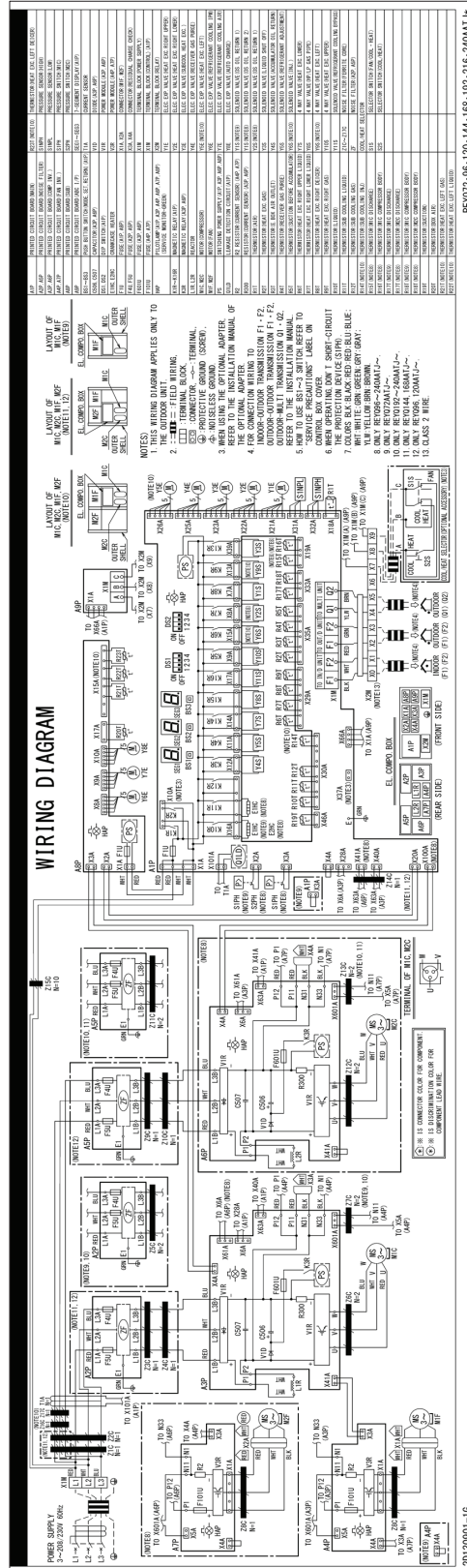

C: 2D130901G

REYQ72/96/120/144/168/192/216/240AAYDA, REYQ72/96/120/144/168/192/216/240AAYDB

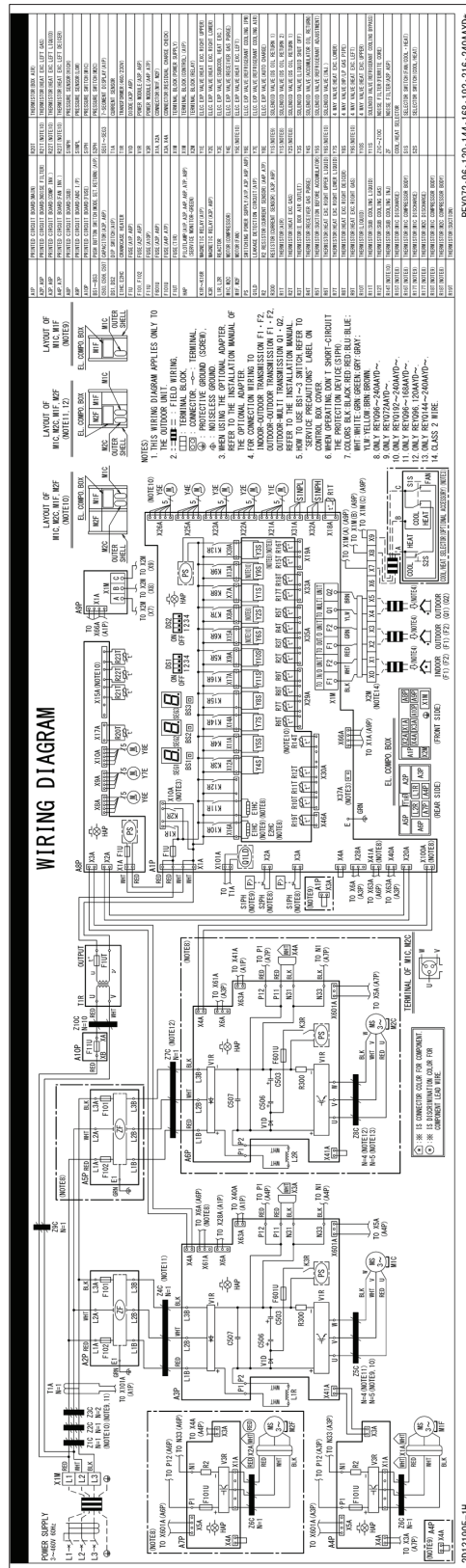

C: 2D131905H

# 1.2 Branch Selector Unit

## 1.2.1 Single Branch Selector Unit

BSQ36/60/96TVJ

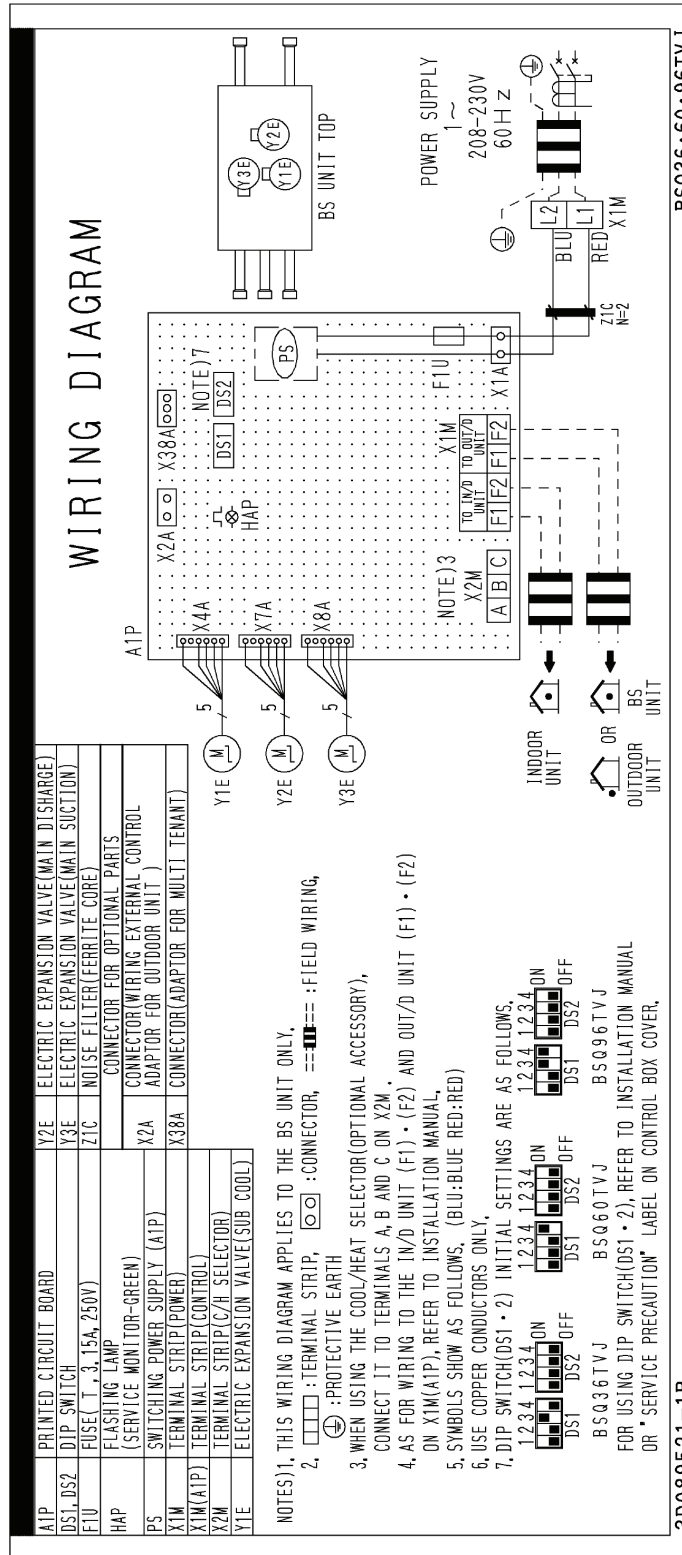

3D089521B

BSQ36/60/96TAVJ

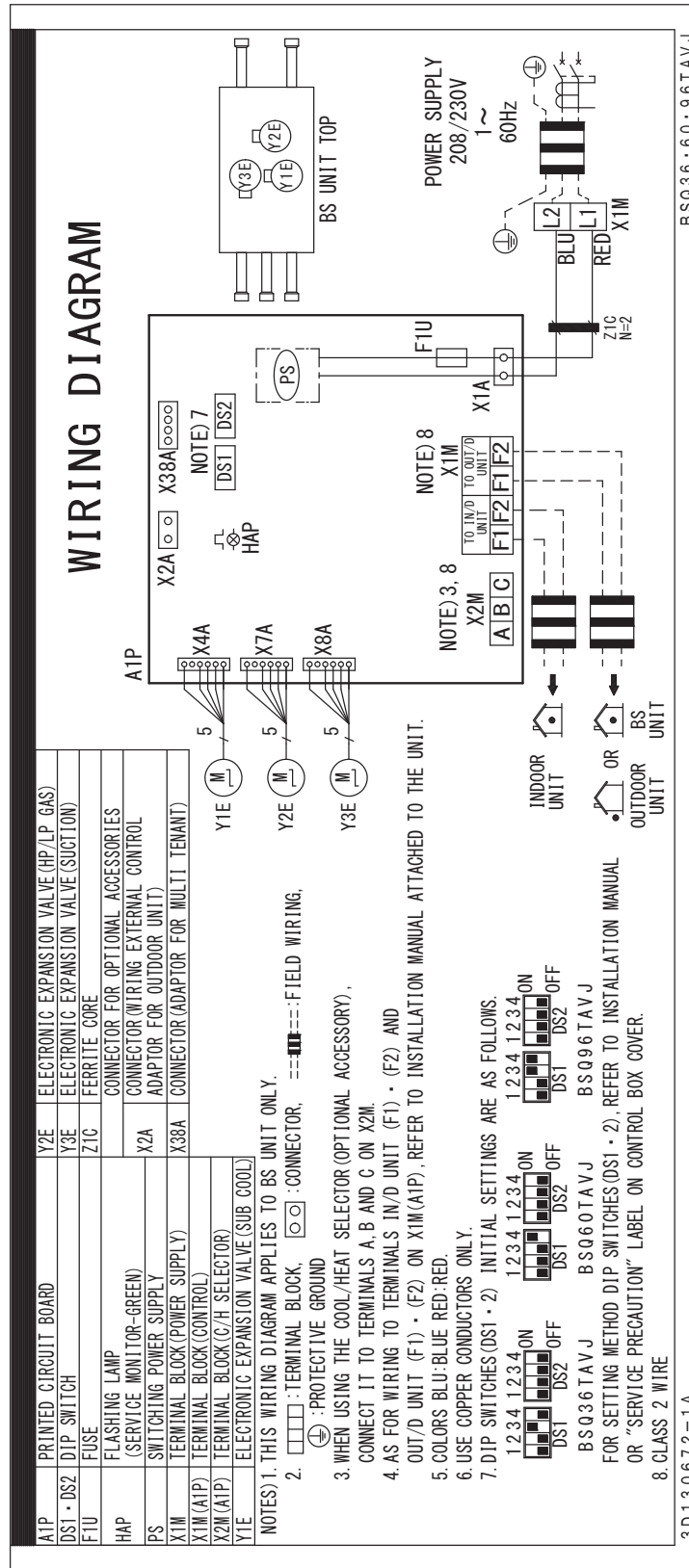

# 1.2.2 Multi Branch Selector Unit (Standard Series)

BS4Q54TVJ

## WIRING DIAGRAM

POWER SUPPLY  
1~208-230V 60Hz

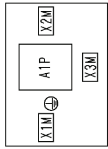

LAYOUT OF CONTROL BOX

NOTE)1. THIS WIRING DIAGRAM IS FOR BS UNIT ONLY.

2. THE MARKS IN THIS DIAGRAM INDICATE:

□: TERMINAL BLOCK, ○: CONNECTOR,  
---: FIELD WIRING, ⊕: PROTECTIVE EARTH,  
⚡: NOISELESS EARTH

3. FOR WIRING FOR THE TERMINAL BLOCK X2M~X3M (OPERATION),

REFER TO THE INSTALLATION MANUAL ATTACHED TO THE PRODUCT.

4. THE FACTORY SETTING OF DIP SWITCH (DS1~DS2) ARE AS FOLLOWS, FOR THE

SETTING METHOD OF DIP SWITCH (DS1~DS2), REFER TO "THE INSTALLATION

MANUAL" AND "PRECAUTION FOR SERVICE" ATTACHED ON THE CONTROL BOX COVER.

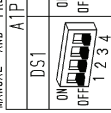

5. COLORS: RED:RED;BLU:BLUE;GRN:GREEN;PK:PK;WHT:WHITE;YLU:YELLOW;  
ORG:ORANGE;BLK:BLACK;BRN:BROWN,  
6. CLASS 2 WIRE.

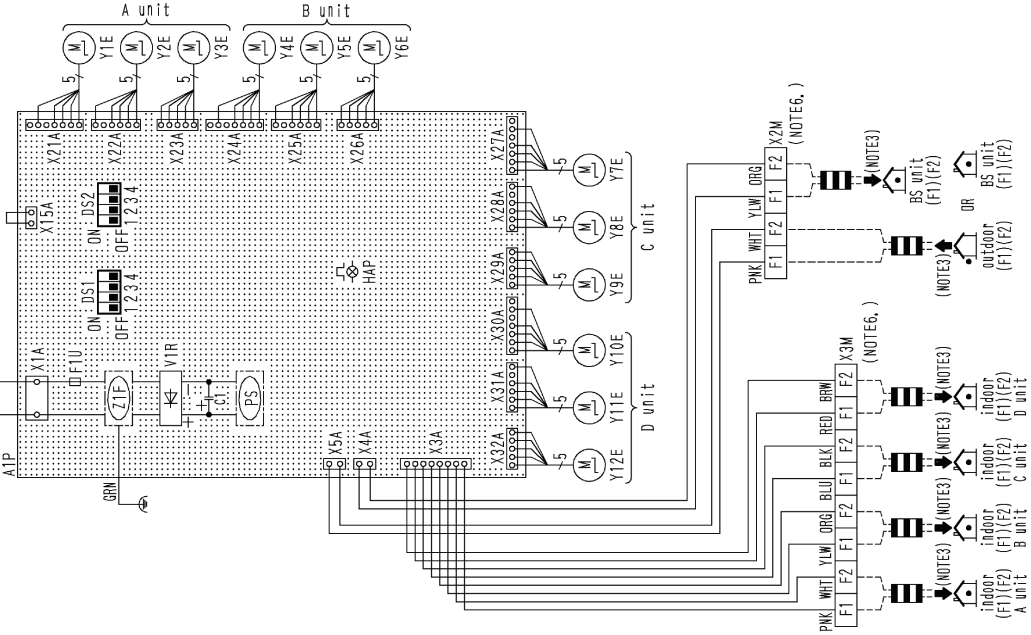

A1P	PRINTED CIRCUIT BOARD (CONTROL)
C1	CAPACITOR
DS1, DS2	DIP SWITCH
FTU	FUSE (T-3, 1.5A, 250V)
HAP	FLASHING LAMP (SERVICE MONITOR-GREEN)
PS	SWITCHING POWER SUPPLY
VIR	DIODE BRIDGE
X1M	TERMINAL STRIP (POWER)
X2M, X3M	TERMINAL STRIP (TRANSMISSION)
Z1F	NOISE FILTER
Y1E	ELECTRIC EXPANSION VALVE (SUCTION) A unit
Y2E	ELECTRIC EXPANSION VALVE (HP/LP GAS) A unit
Y3E	ELECTRIC EXPANSION VALVE (SUB COOL) A unit
Y4E	ELECTRIC EXPANSION VALVE (SUCTION) B unit
Y5E	ELECTRIC EXPANSION VALVE (HP/LP GAS) B unit
Y6E	ELECTRIC EXPANSION VALVE (SUB COOL) B unit
Y7E	ELECTRIC EXPANSION VALVE (SUCTION) C unit
Y8E	ELECTRIC EXPANSION VALVE (HP/LP GAS) C unit
Y9E	ELECTRIC EXPANSION VALVE (SUB COOL) C unit
Y10E	ELECTRIC EXPANSION VALVE (SUCTION) D unit
Y11E	ELECTRIC EXPANSION VALVE (HP/LP GAS) D unit
Y12E	ELECTRIC EXPANSION VALVE (SUB COOL) D unit

BS4Q54TVJ

3D089123-1A

3D089123B

BS4Q54TAVJ

3D130867B

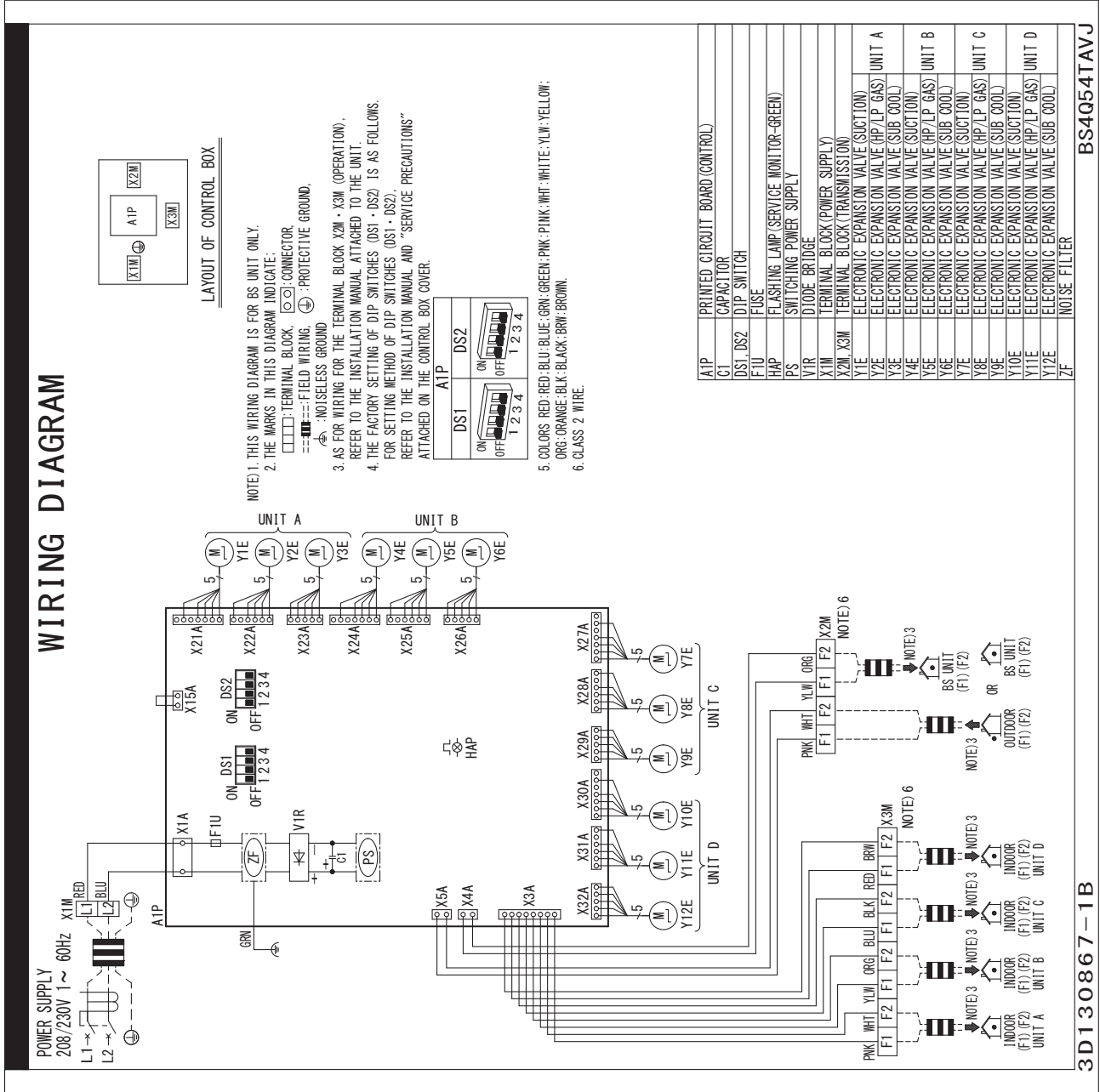



BS6/8Q54TVJ

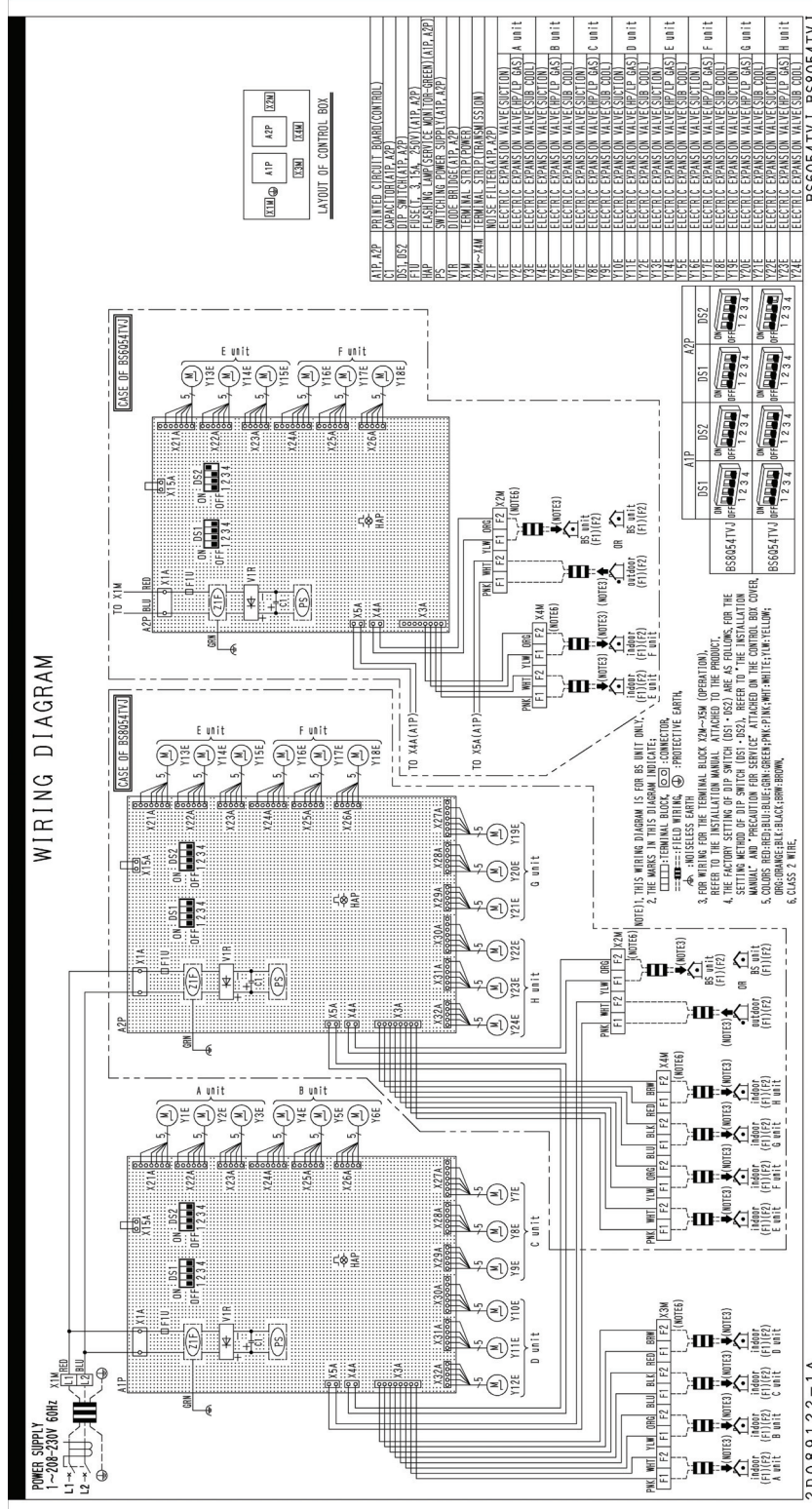

2D089122B



BS10/12Q54TVJ

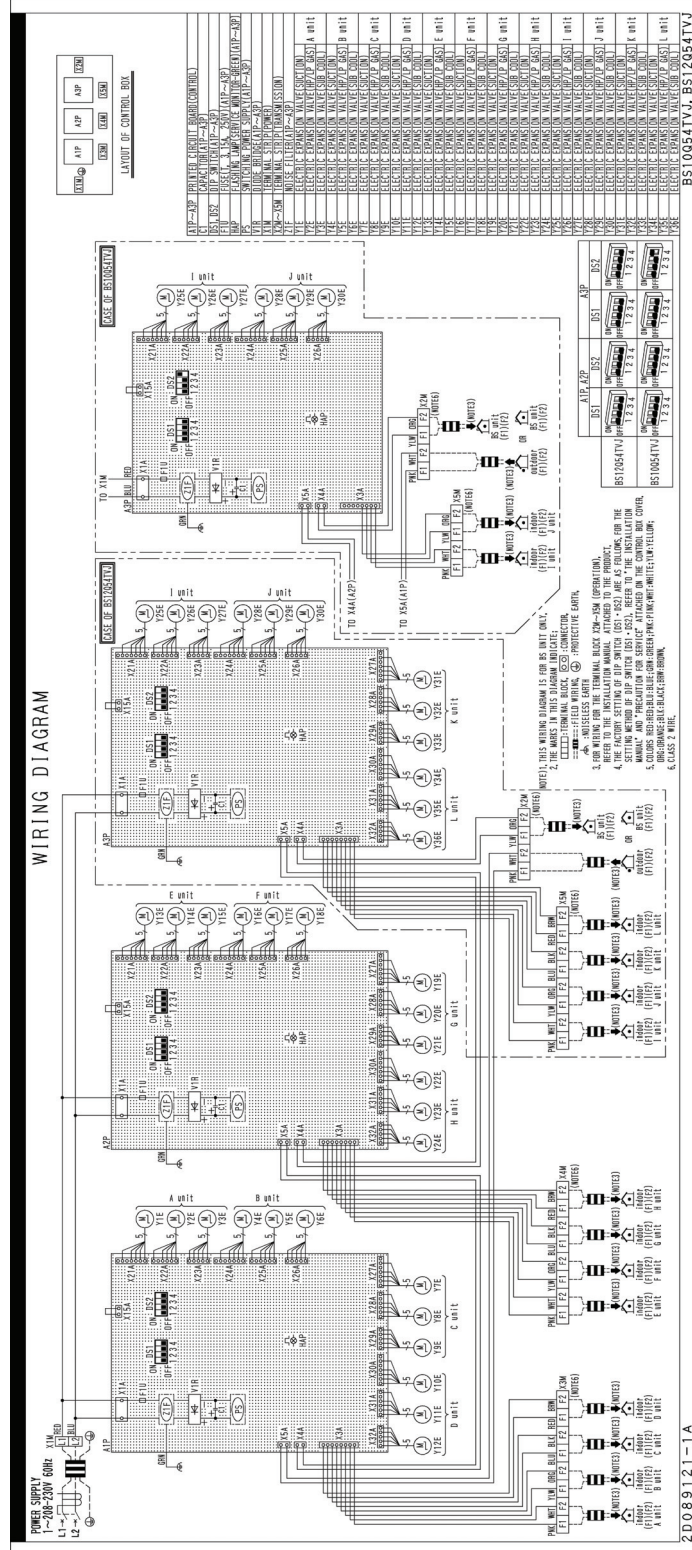

2D089121B

BS10/12Q54TAVJ

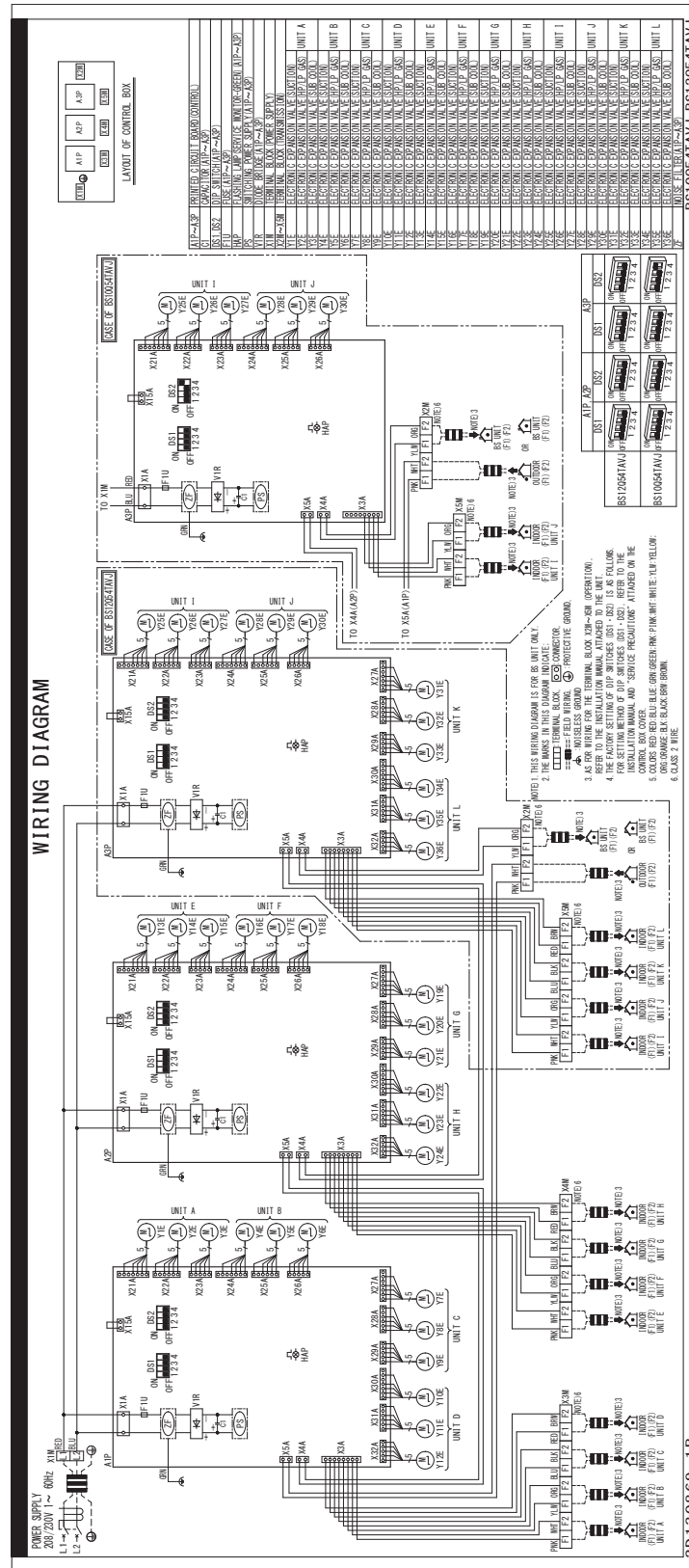

BS10G64TAVJ, BS12Q54TAVJ

2D130869-1B

2D130869B

### 1.2.3 Multi Branch Selector Unit (Flex Series)

BSF4Q54TVJ

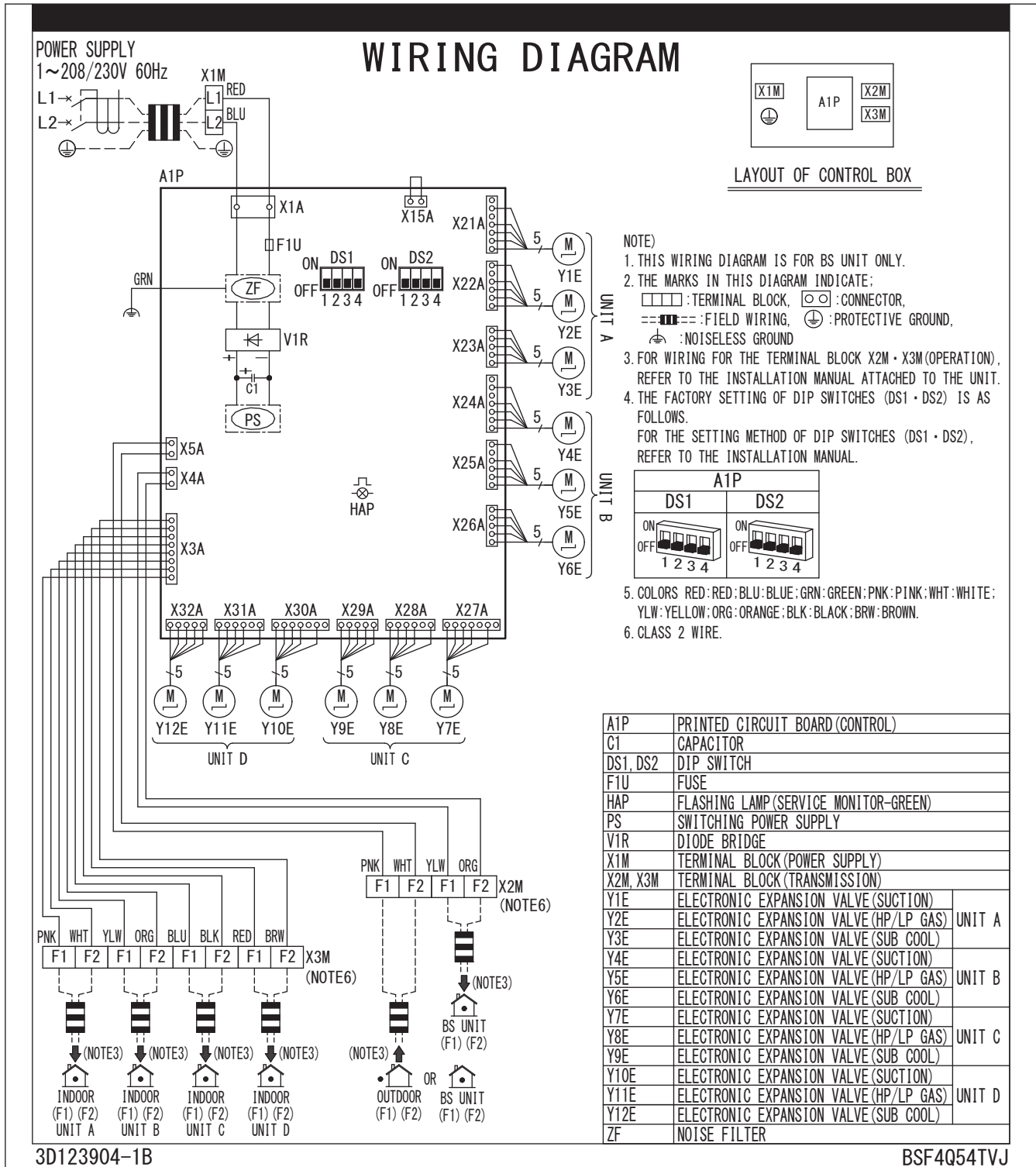

3D123904-1B

BSF4Q54TVJ

3D123904B

BSF6/8Q54TVJ

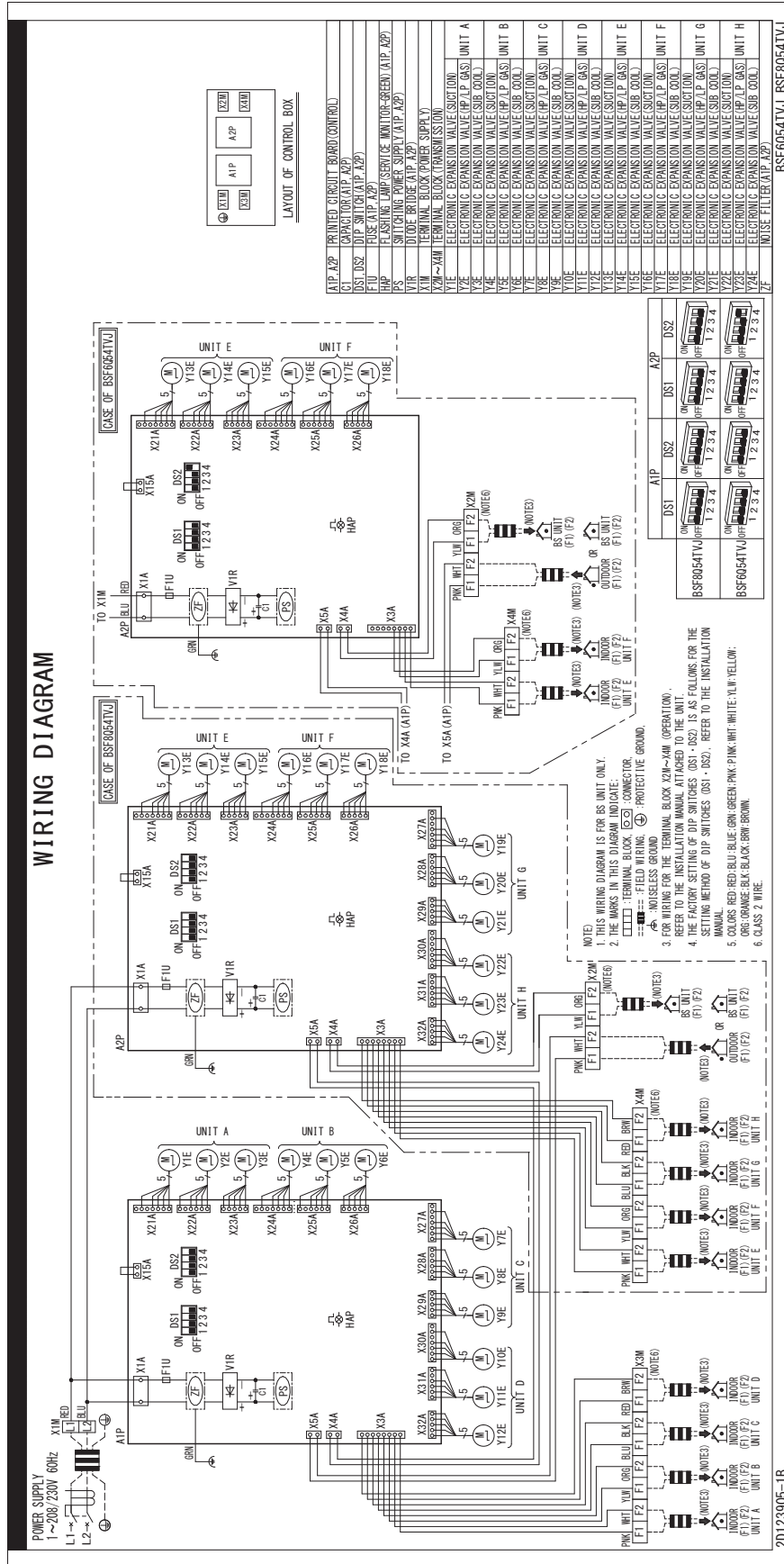

# 1.3 Indoor Unit

FXFQ07/09/12/15/18/24/30/36/48/54AAVJU

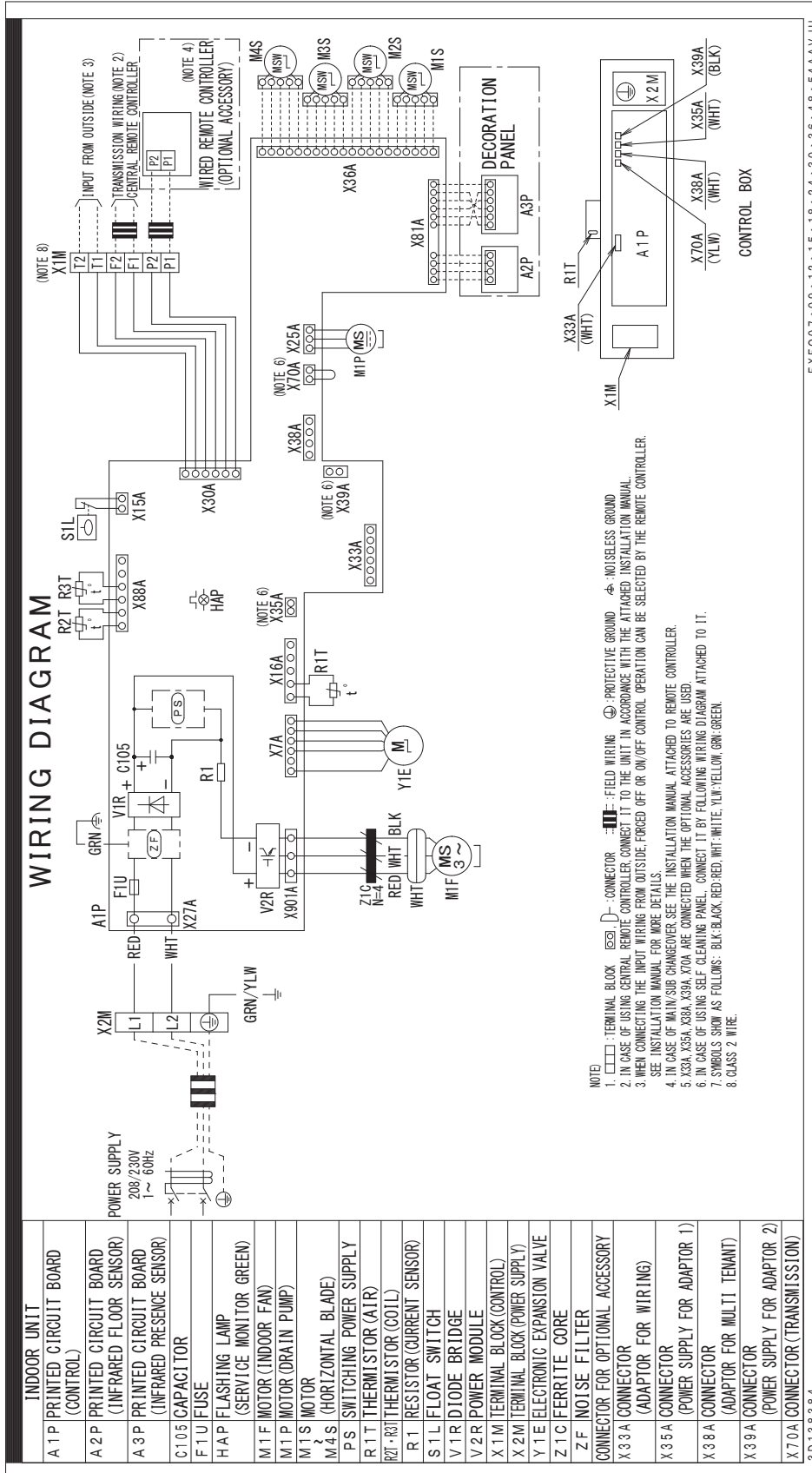

BYCQ54EEGFU (Self-Cleaning Decoration Panel for FXFQ-AA)

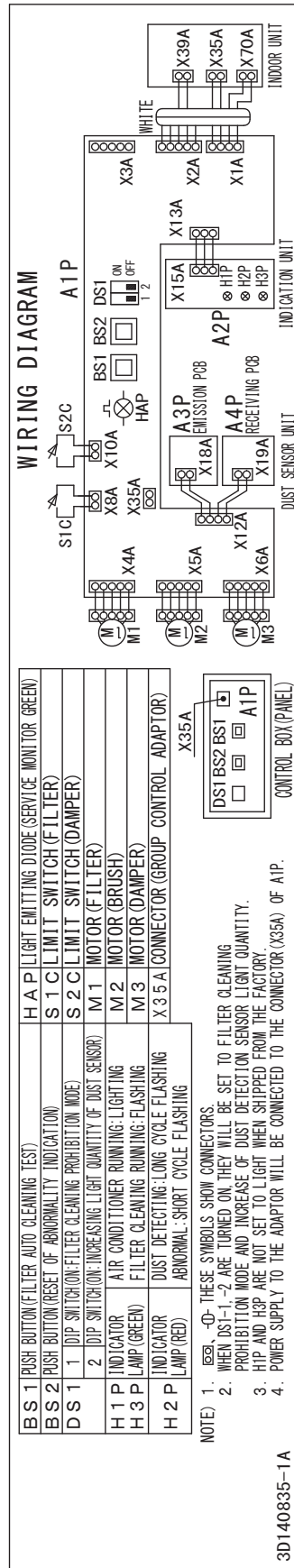

3D140835A



FXFQ07/09/12/15/18/24/30/36/48TVJU\*

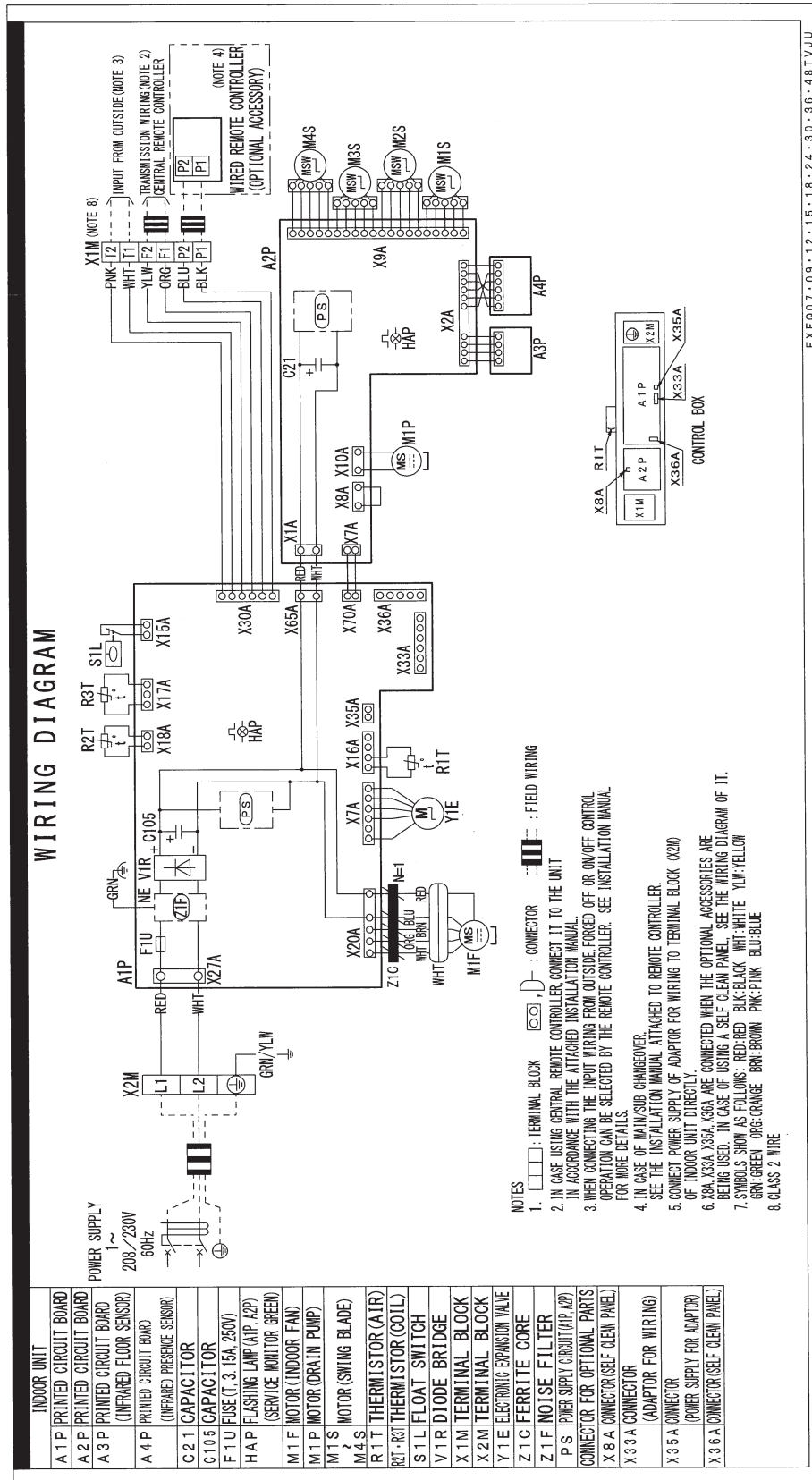

FXFQ07.09.12.15.18.24.30.36.48TVJU

3D086460B

BYCQ125BGW1 (Self-Cleaning Decoration Panel for FXFQ-TVJU\*)

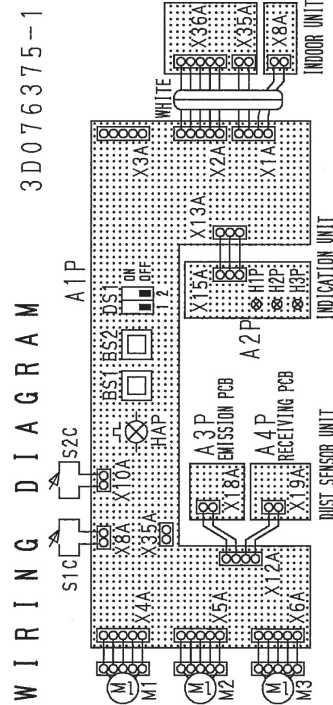

BS1	PUSH BUTTON(FILTER AUTO CLEANING TEST)	HAP	LIGHT EMITTING DIODE(SERVICE MONITOR GREEN)
BS2	PUSH BUTTON(RESET OF ABNORMALITY INDICATION)	S1C	LIMIT SWITCH(FILTER)
DS1	1 DIP SWITCH(FILTER CLEANING PROHIBITION MODE)	S2C	LIMIT SWITCH(DAMPER)
	2 DIP SWITCH(ON: INCREASING LIGHT QUANTITY OF DUST SENSOR)	M1	MOTOR(FILTER)
H1P	INDICATOR AC RUNNING: LIGHTING	M2	MOTOR(BRUSH)
H3P	LAMP(GREEN) FILTER CLEANING RUNNING: FLASHING	M3	MOTOR(DAMPER)
H2P	LAMP(RED) INDICATOR DUST DETECTING: LONG CYCLE FLASHING	X35A	CONNECTOR(GROUP CONTROL ADAPTOR)

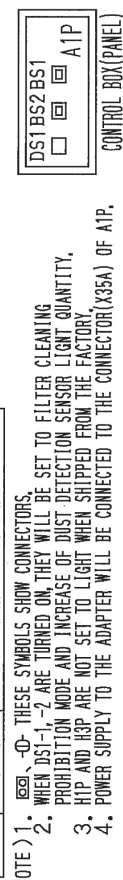

NOTE) 1. THESE SYMBOLS SHOW CONNECTORS.  
 2. WHEN DS1-1, -2 ARE TURNED ON, THEY WILL BE SET TO FILTER CLEANING PROHIBITION MODE AND INCREASE OF DUST DETECTION SENSOR LIGHT QUANTITY.  
 3. H1P AND H3P ARE NOT SET TO LIGHT WHEN SHIPPED FROM THE FACTORY.  
 4. POWER SUPPLY TO THE ADAPTOR WILL BE CONNECTED TO THE CONNECTOR(X35A) OF A1P.

3D076375A



FXZQ05/07/09/12/15/18TAVJU\*

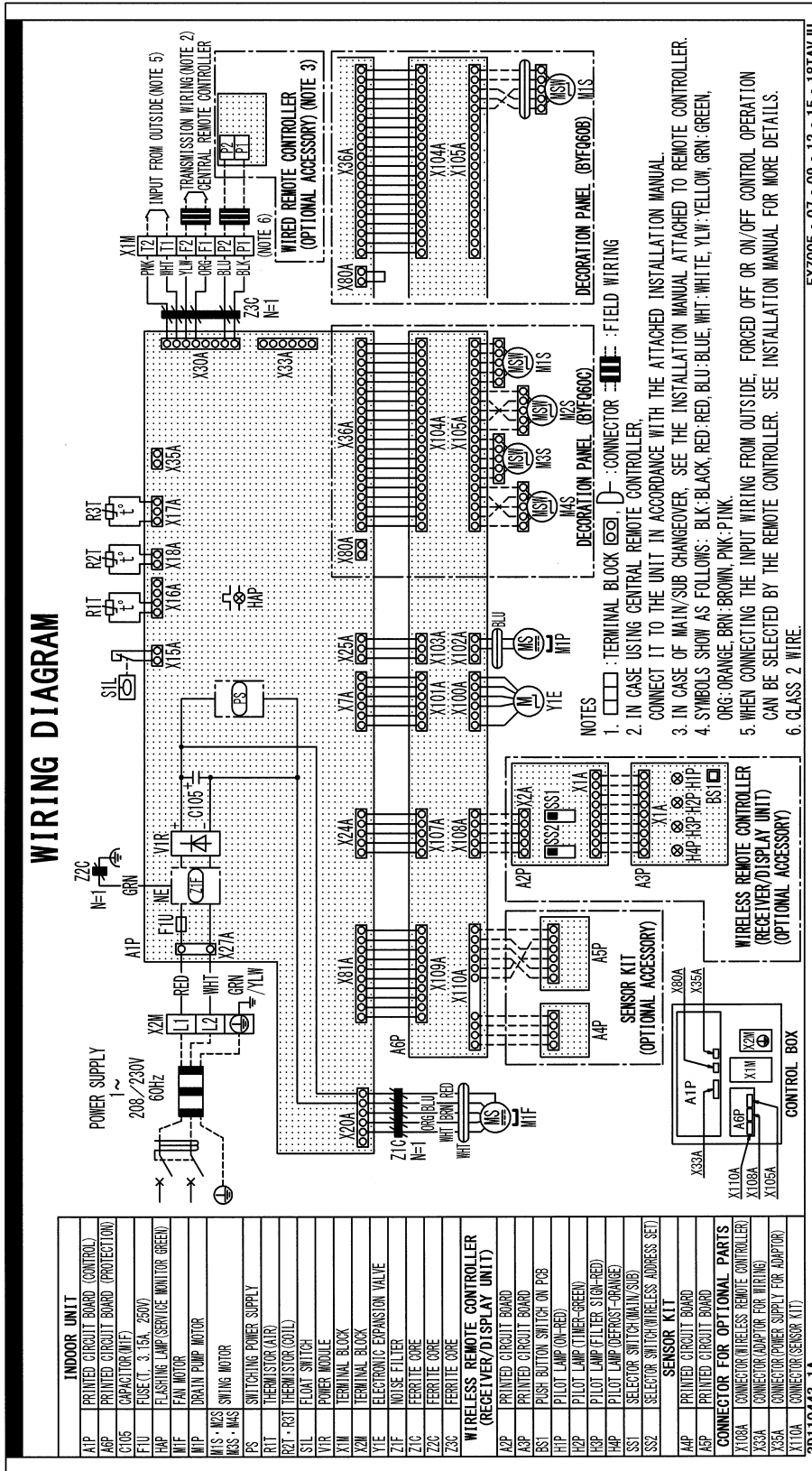

3D110443A

FXZQ05 - 07 - 09 - 12 - 15 - 18TAVJU

FXZQ05/07/09/12/15/18TBVJU\*

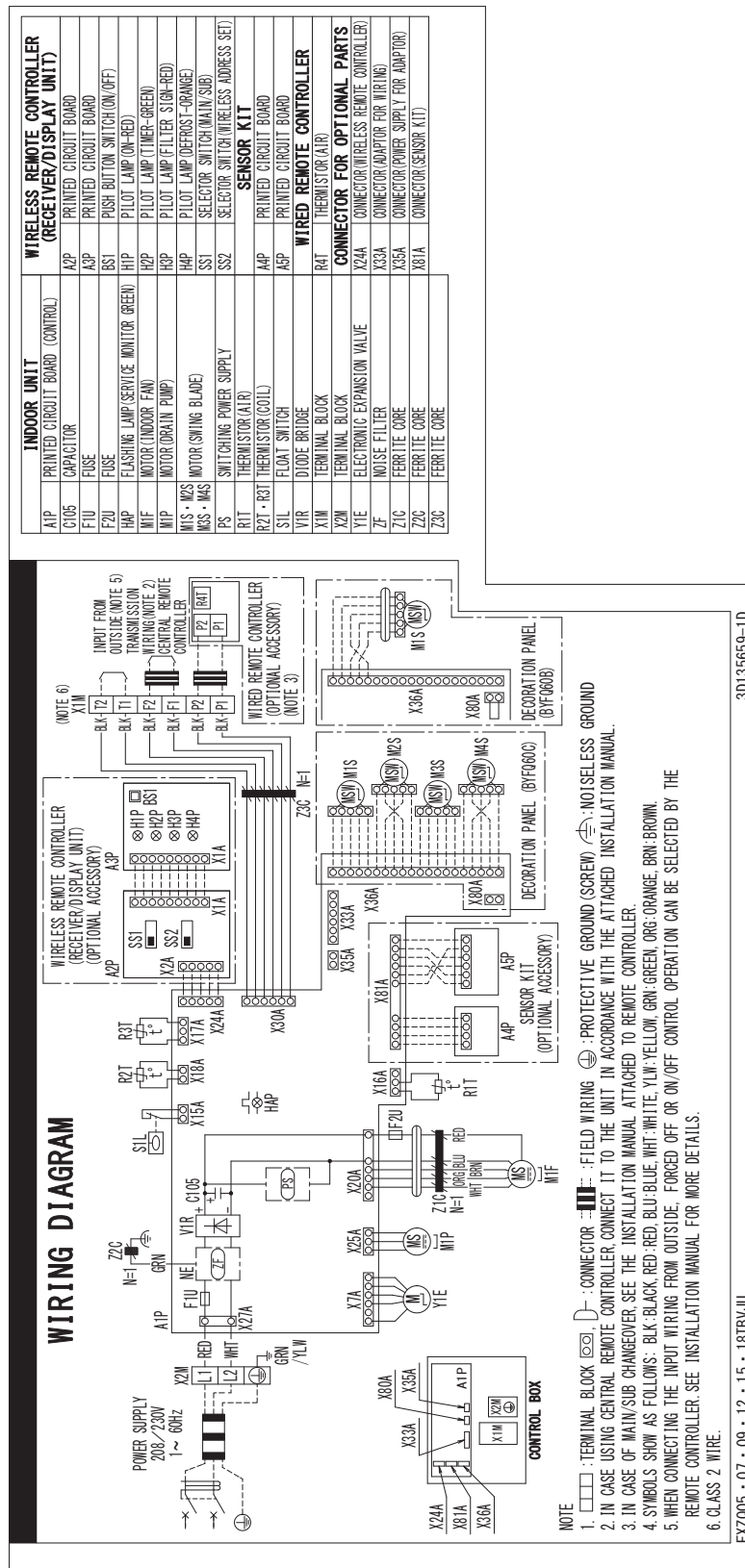

3D135659D

FXUQ18/24/30/36PVJU\*

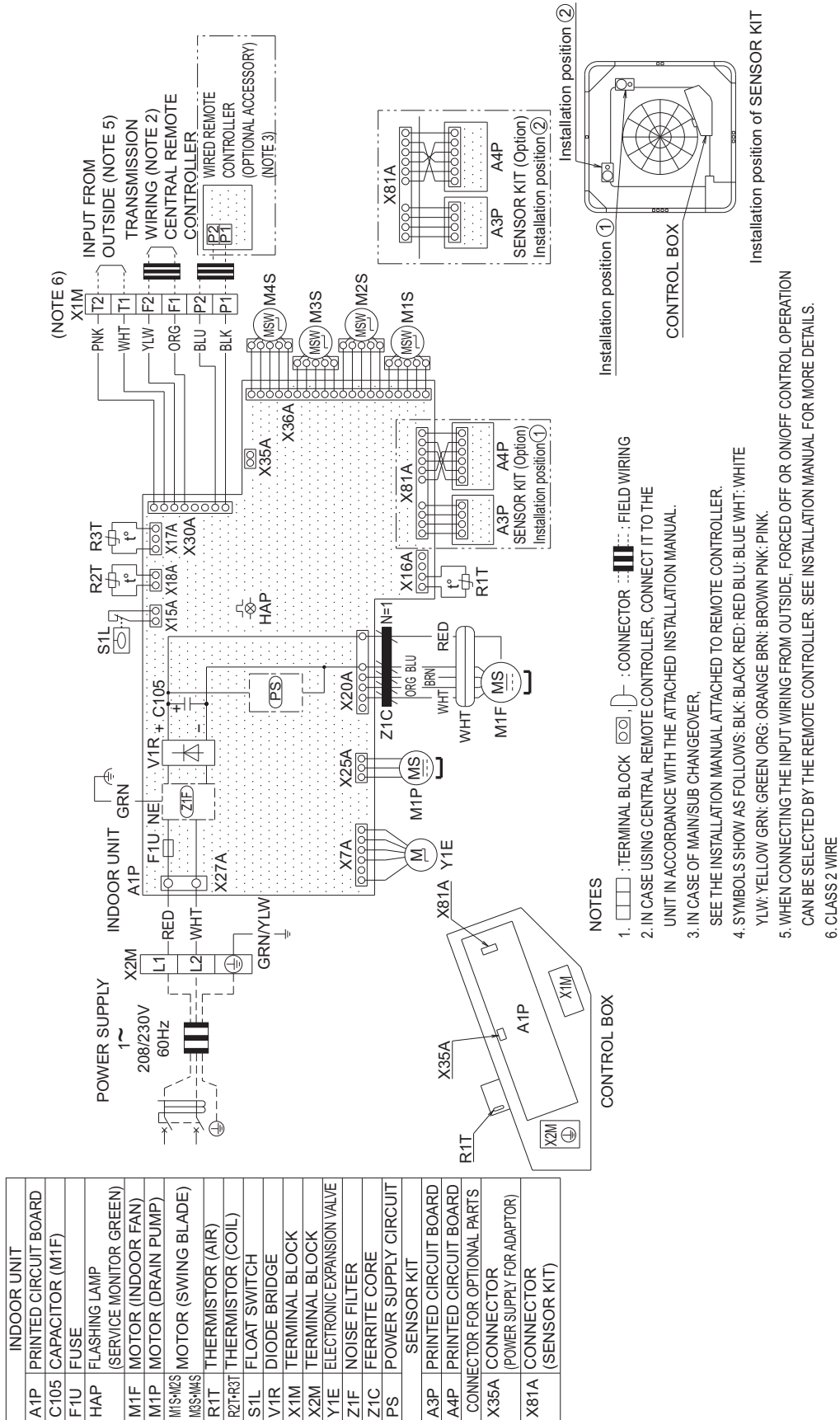

3D090218

FXUQ18/24/30/36PAVJU\*

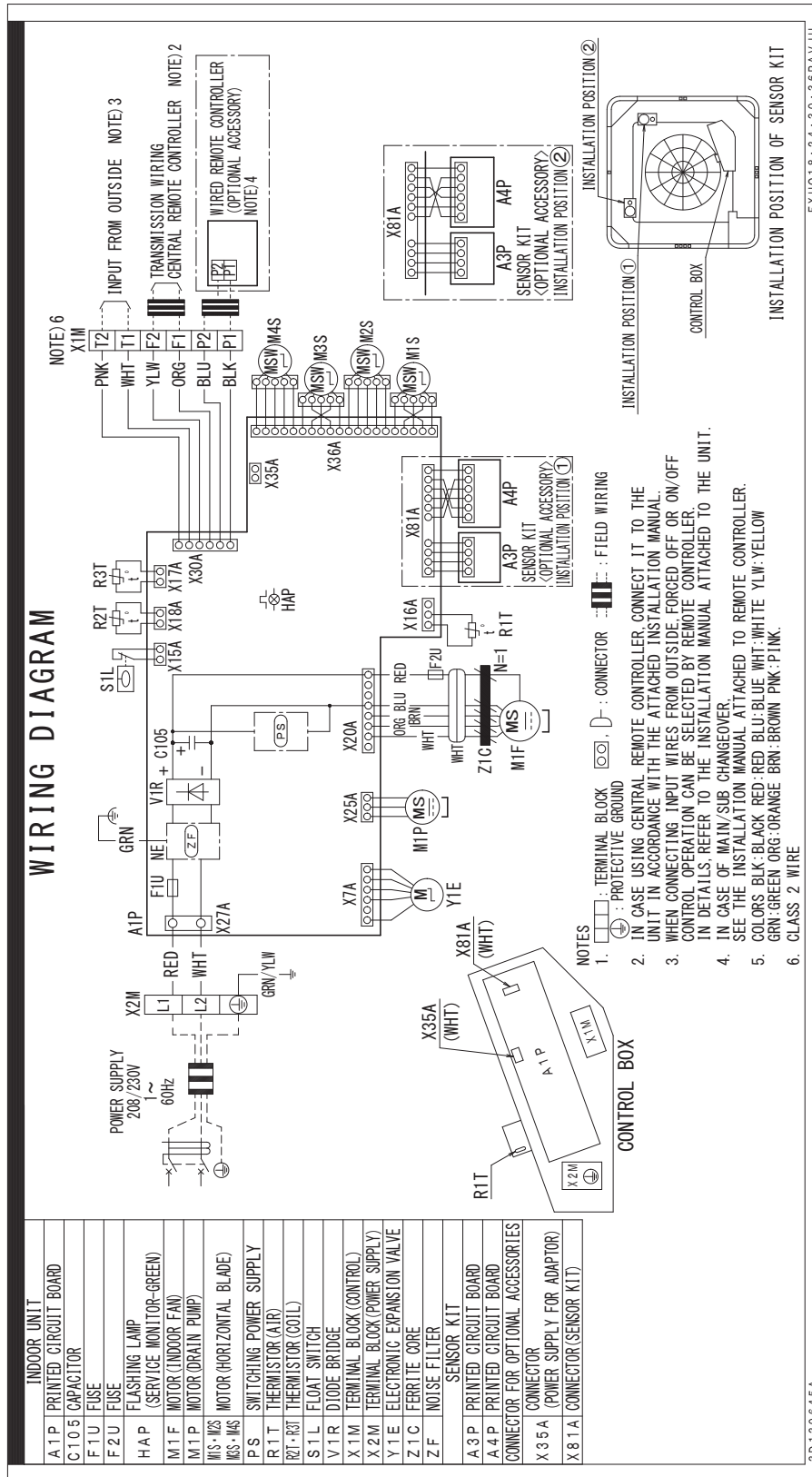

3D130645A

FXEQ07/09/12/15/18/24PVJU\*

WIRING DIAGRAM

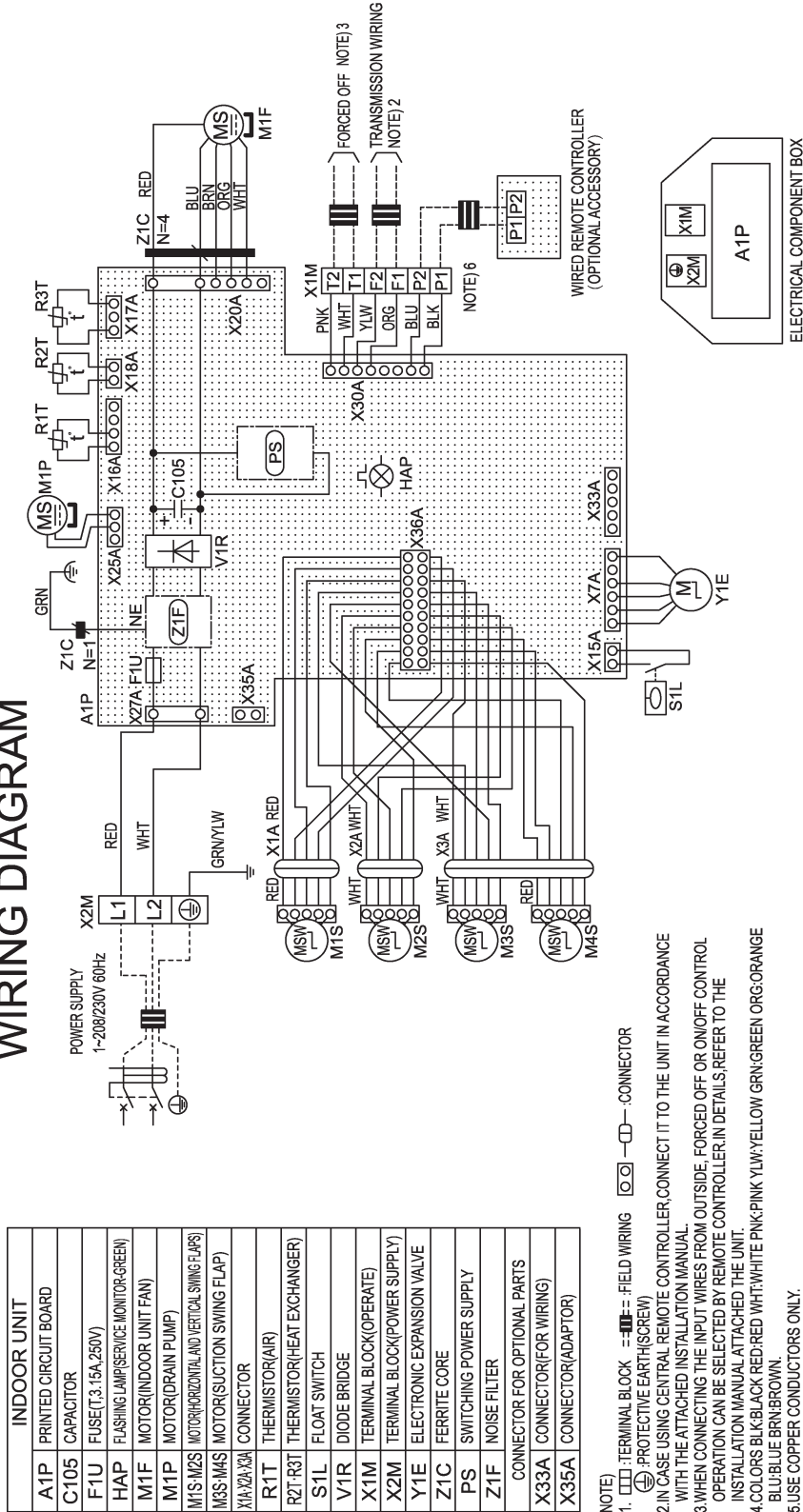

INDOOR UNIT	
A1P	PRINTED CIRCUIT BOARD
C105	CAPACITOR
F1U	FUSE(T:3.15A,250V)
HAP	FLASHING LAMP(SERVICE MONITOR-GREEN)
M1P	MOTOR(INDOOR UNIT FAN)
M1F	MOTOR(DRAIN PUMP)
M1S, M2S	MOTOR(HORIZONTAL AND VERTICAL SWING FLAPS)
M3S, M4S	MOTOR(SUCTION SWING FLAP)
X1A, X2A, X3A	CONNECTOR
R1T	THERMISTOR(AIR)
R2T, R3T	THERMISTOR(HEAT EXCHANGER)
S1L	FLOAT SWITCH
V1R	DIODE BRIDGE
X1M	TERMINAL BLOCK(OPERATE)
X2M	TERMINAL BLOCK(POWER SUPPLY)
Y1E	ELECTRONIC EXPANSION VALVE
Z1C	FERRITE CORE
PS	SWITCHING POWER SUPPLY
Z1F	NOISE FILTER
CONNECTOR FOR OPTIONAL PARTS	
X33A	CONNECTOR(FOR WIRING)
X35A	CONNECTOR(ADAPTOR)

- NOTE)
1. □ □ □ □ : FIELD WIRING □ □ □ □ : CONNECTOR
  2. IN CASE USING CENTRAL REMOTE CONTROLLER, CONNECT IT TO THE UNIT IN ACCORDANCE WITH THE ATTACHED INSTALLATION MANUAL.
  3. WHEN CONNECTING THE INPUT WIRES FROM OUTSIDE, FORCED OFF OR ON/OFF CONTROL OPERATION CAN BE SELECTED BY REMOTE CONTROLLER. IN DETAILS, REFER TO THE INSTALLATION MANUAL ATTACHED THE UNIT.
  4. COLORS: BLK:BLACK, RED:RED, WHT:WHITE, PNK:PINK, YLW:YELLOW, GRN:GREEN, ORG:ORANGE, BLU:BLUE, BRN:BROWN.
  5. USE COPPER CONDUCTORS ONLY.
  6. CLASS 2 WIRE.

3D098557-1A

3D098557A

FXDQ07/09/12/18/24MVJU\*

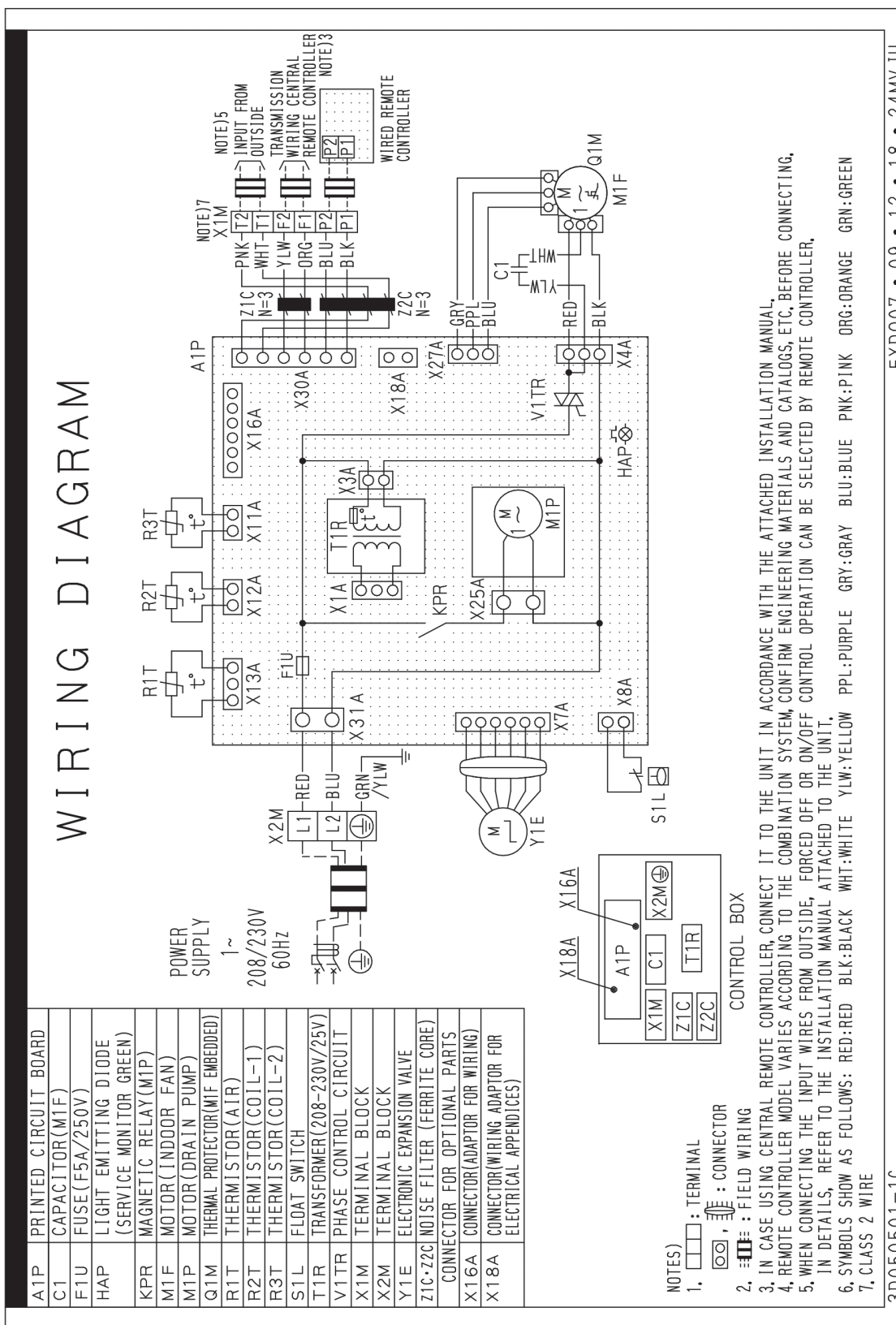

C:3D050501C

FXDQ07 • 09 • 12 • 18 • 24MVJU

FXSQ05/07/09/12/15/18/24/30/36/48/54TAVJU\*

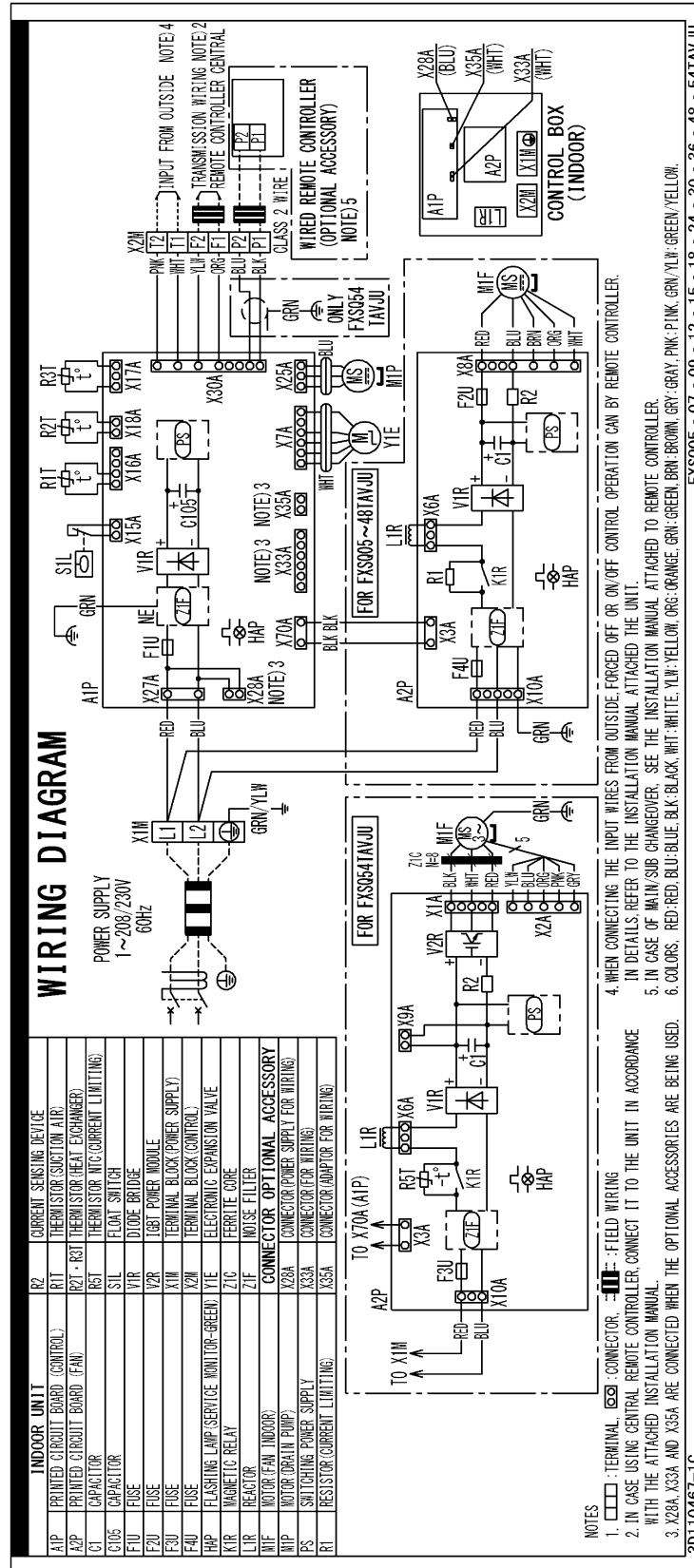

C: 3D110467C

FXSQ05/07/09/12/15/18/24/30/36/48/54TBVJU

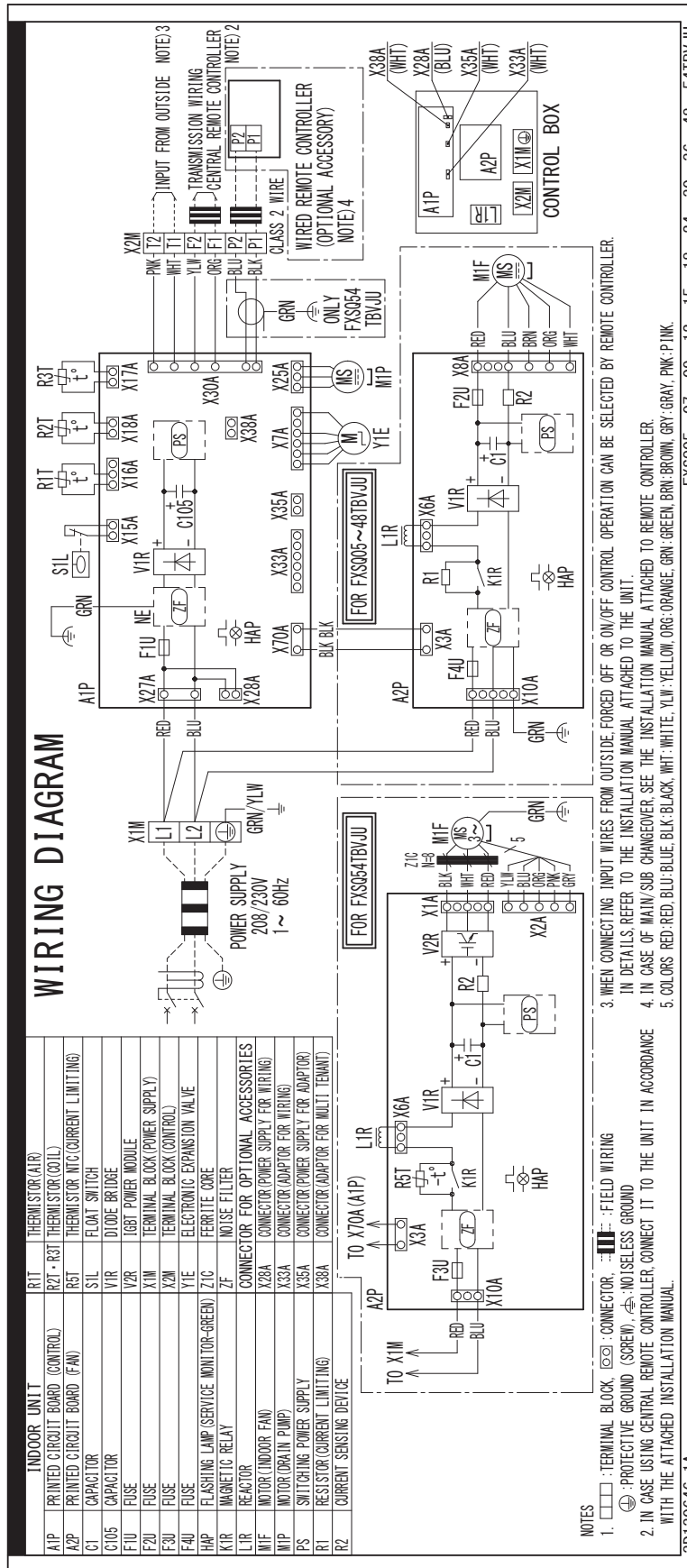

3D130646B



FXMQ07/09/12/15/18/24/30/36/48/54PBVJU\*

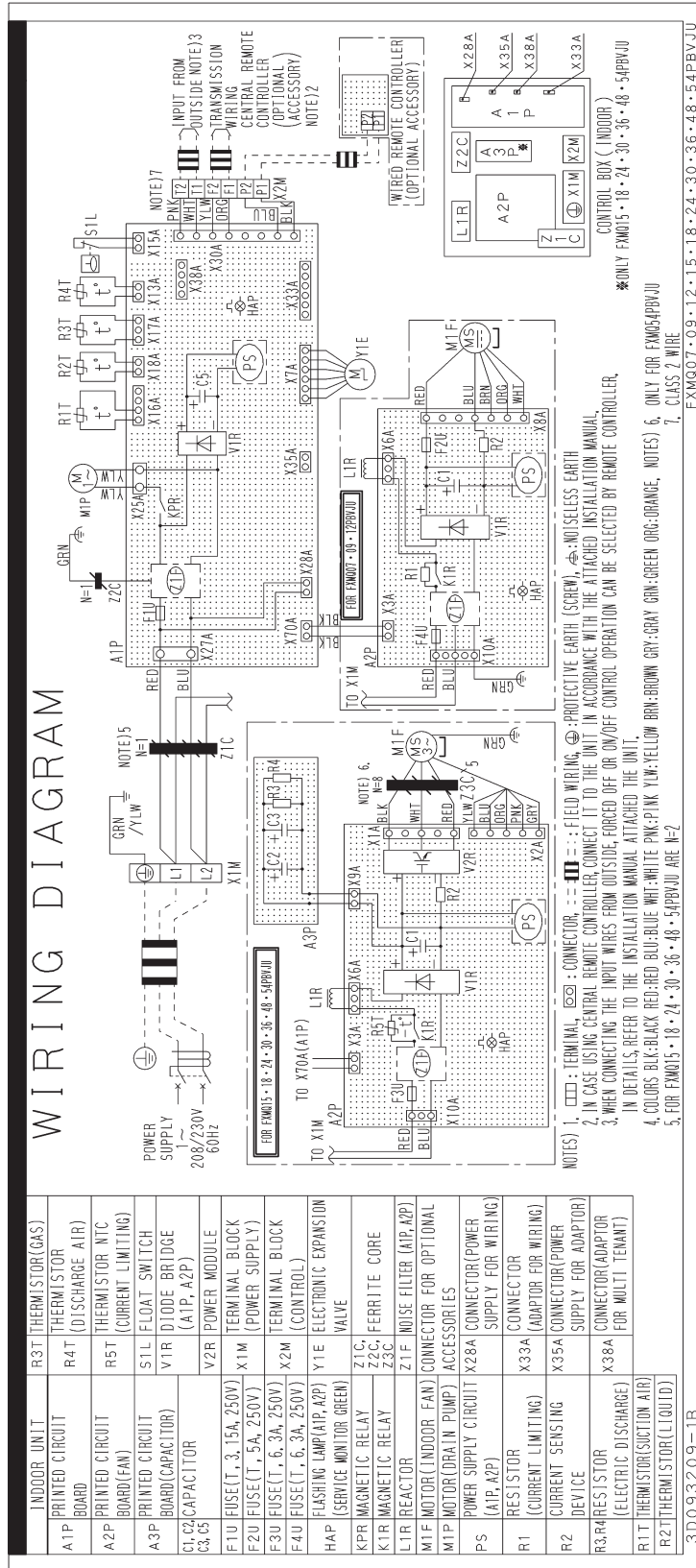

FXMQ15/18/24/30/36/48/54TBVJU

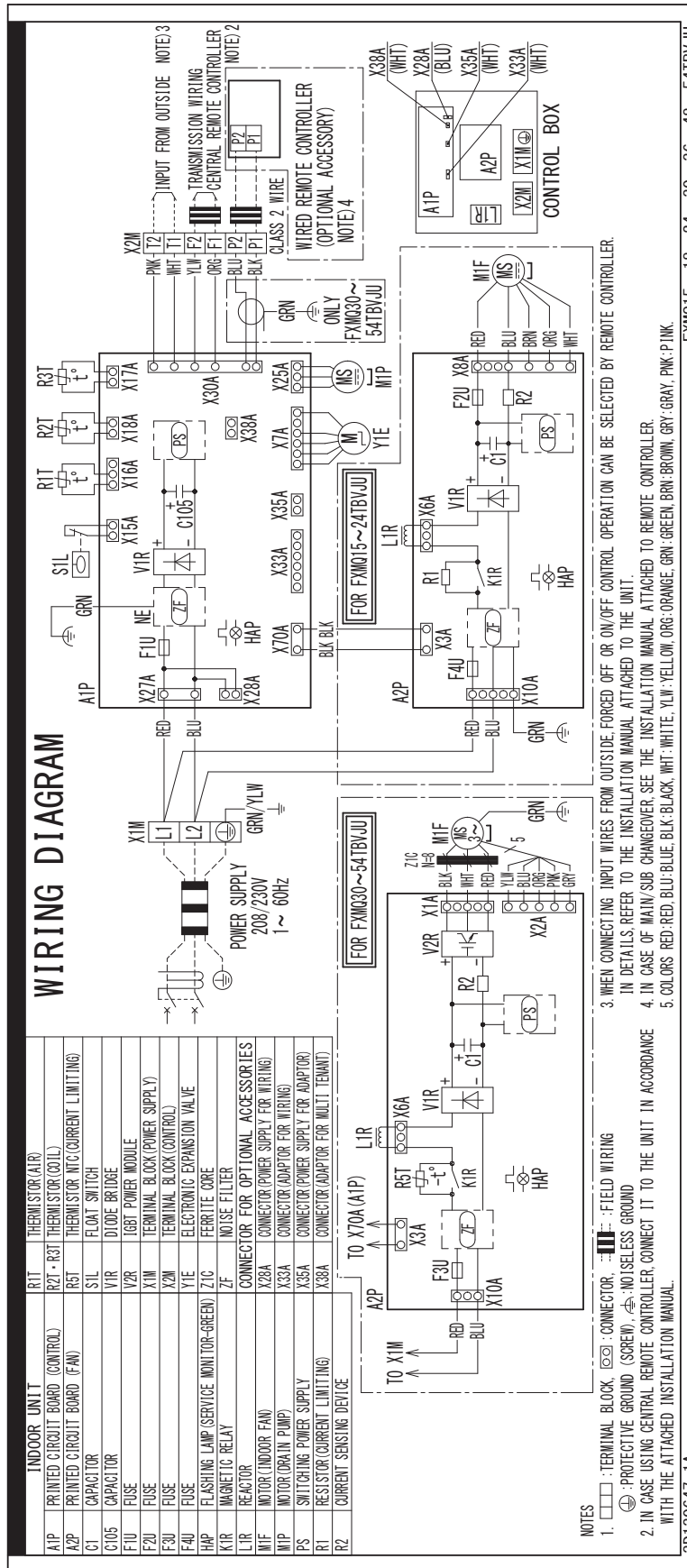

3D130647B

FXMQ72/96TAVJU

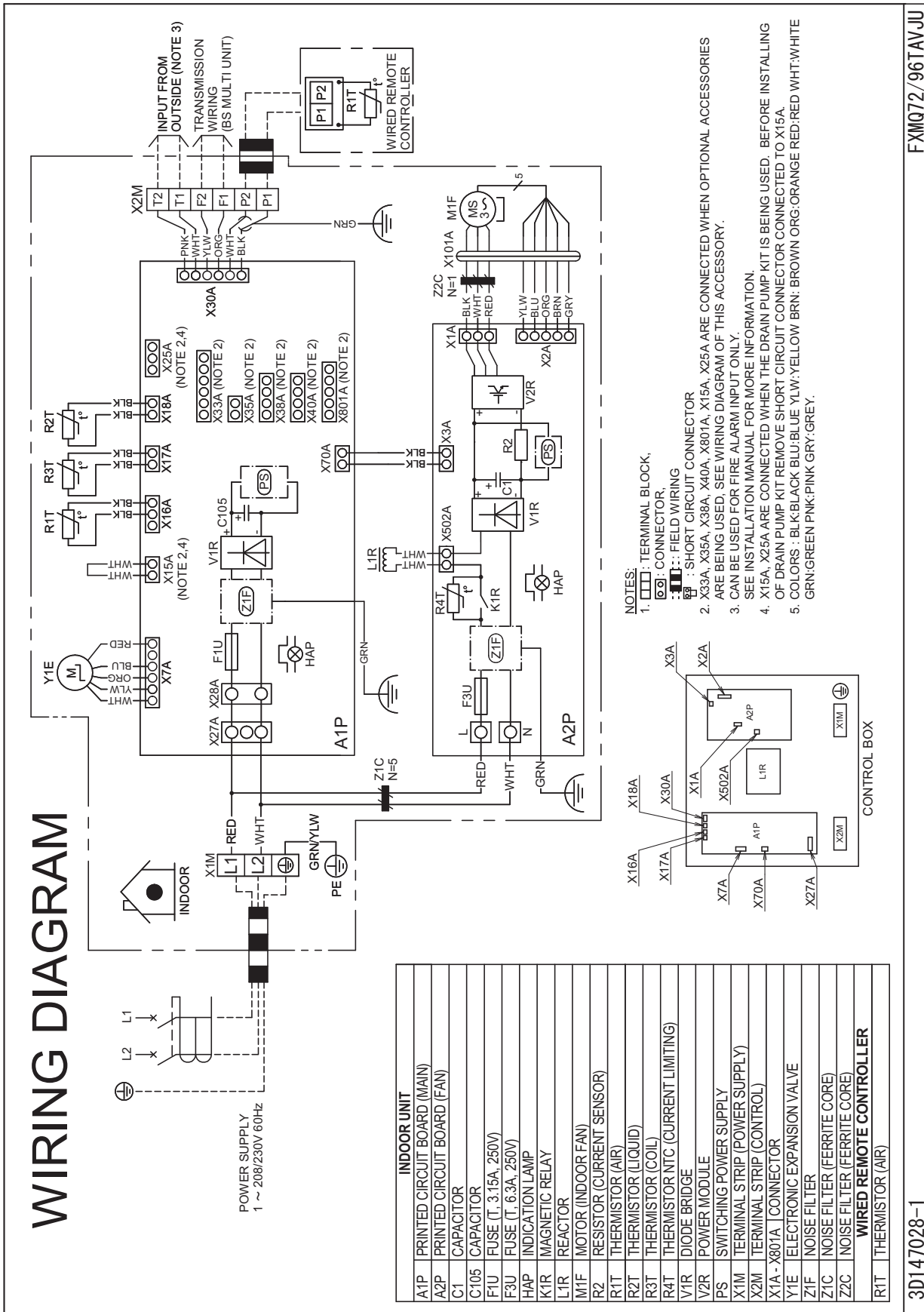

FXMQ72/96MVJU\*

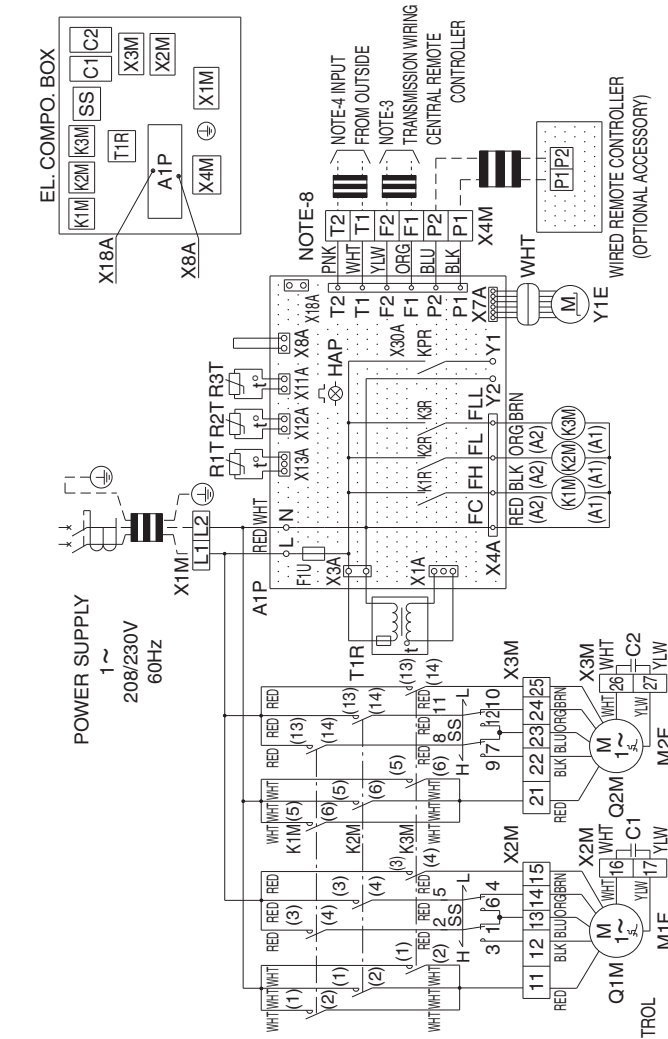

A1P	INDOOR UNIT	R1T	THERMISTOR (AIR)
C1•C2	PRINTED CIRCUIT BOARD	R2T•R3T	THERMISTOR (COIL)
F1U	CAPACITOR (M1F•2F)	SS	SELECTOR SWITCH (STATIC PRESSURE)
HAP	FUSE (⑤, 5A, 250V)	T1R	TRANSFORMER (208V/230V, 25VA)
K1M	LIGHT EMITTING DIODE (SERVICE MONITOR-GREEN)	X1M	TERMINAL BLOCK (POWER)
K2M	MAGNETIC CONTACTOR (M1F•2F)	X2M•X3M	TERMINAL BLOCK
K3M	MAGNETIC CONTACTOR (M1F•2F)	X4M	TERMINAL BLOCK (CONTROL)
K1R•K3R	MAGNETIC RELAY (M1F•2F)	Y1E	ELECTRONIC EXPANSION VALVE
KPR	MAGNETIC RELAY (M1P)	CONNECTOR FOR OPTIONAL PARTS	
M1F•M2F	MOTOR (INDOOR FAN)	X8A	CONNECTOR (FLOAT SWITCH)
Q1M•Q2M	THERMO. SWITCH (M1F•2F EMBEDDED)	X18A	CONNECTOR (WIRING ADAPTOR FOR ELECTRICAL APPENDICES)

- NOTES
- : TERMINAL BLOCK  
 □□, D- : CONNECTOR  
 : SHORT CIRCUIT CONNECTOR  
 ○—○ : TERMINAL  
 —○— : FIELD WIRING
  - IN CASE USING CENTRAL REMOTE CONTROLLER, CONNECT IT TO THE UNIT IN ACCORDANCE WITH THE ATTACHED INSTALLATION MANUAL.
  - WHEN CONNECTING THE INPUT WIRES FROM OUTSIDE, FORCED OFF OR ON/OFF CONTROL OPERATION CAN BE SELECTED BY REMOTE CONTROLLER. IN DETAILS, REFER TO THE INSTALLATION MANUAL ATTACHED THE UNIT.
  - SYMBOLS SHOW AS FOLLOWS. (PNK: PINK WHT: WHITE YLW: YELLOW ORG: ORANGE BLU: BLUE BLK: BLACK RED: RED BRN: BROWN)
  - USE COPPER CONDUCTORS ONLY.
  - IN CASE HIGH E.S.P. OPERATION, CHANGE THE SWITCH (SS) FOR "H".
  - CLASS 2 WIRE.

3D065414D

FXHQ12/24/36MVJU\*

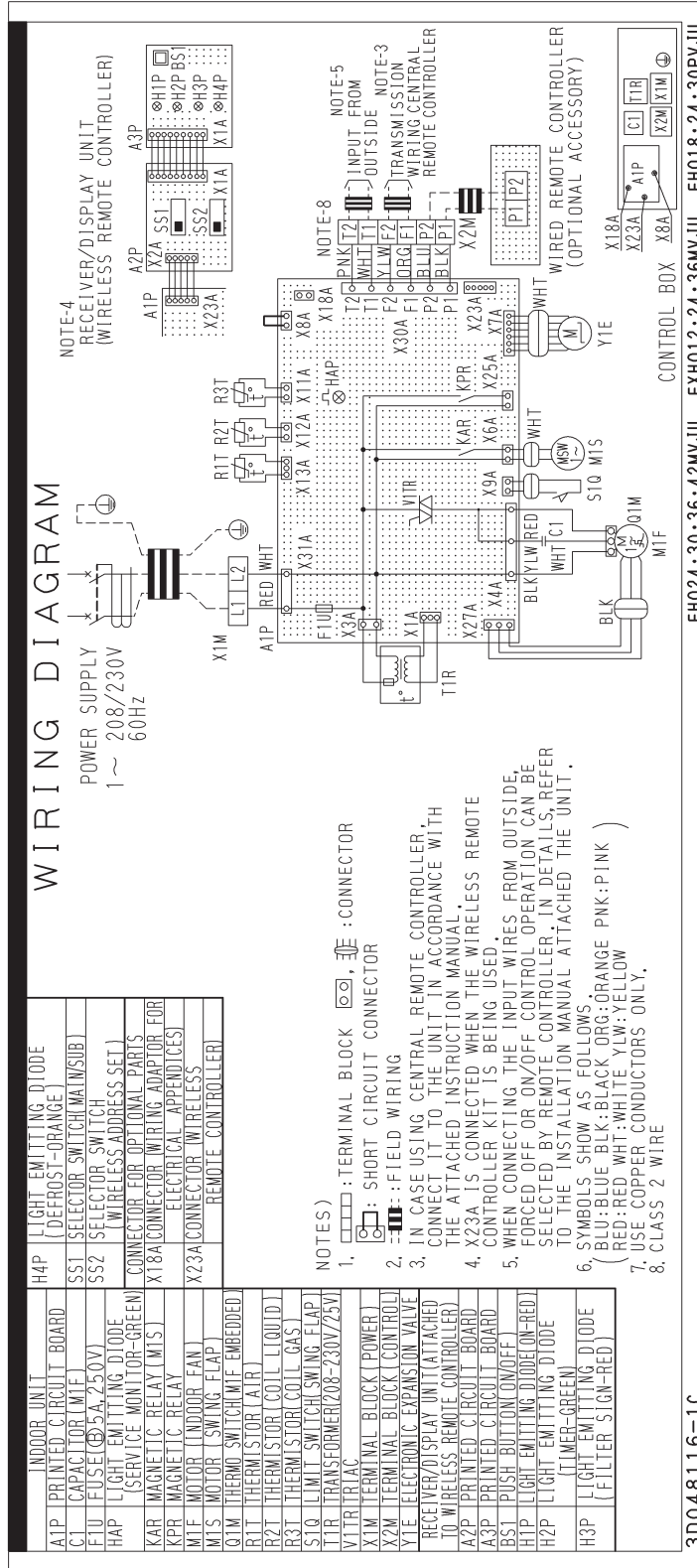

3D048116C

FXAQ07/09/12/18/24PVJU\*

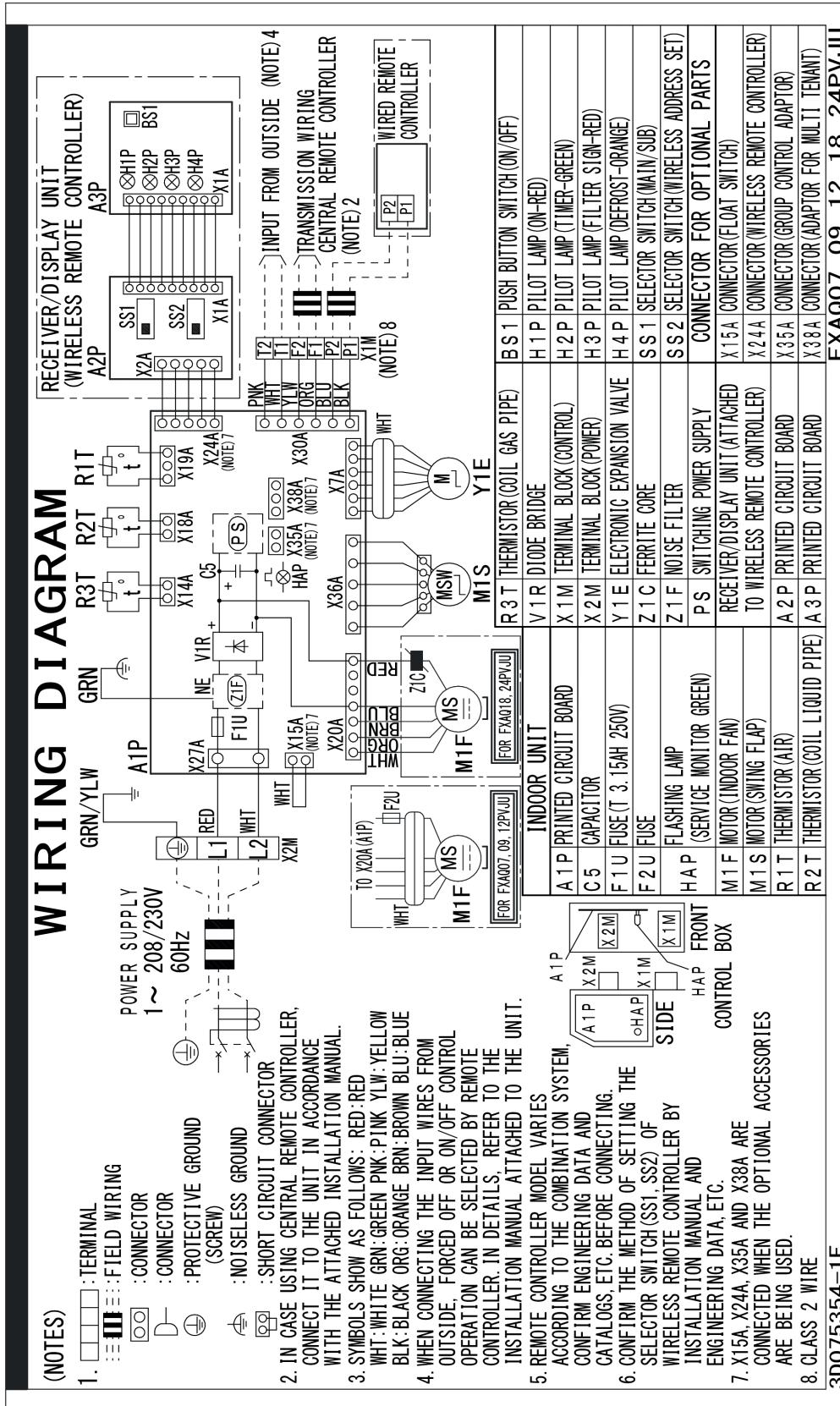

FXLQ07/09/12/18/24MVJU\*, FXNQ07/09/12/18/24MVJU\*

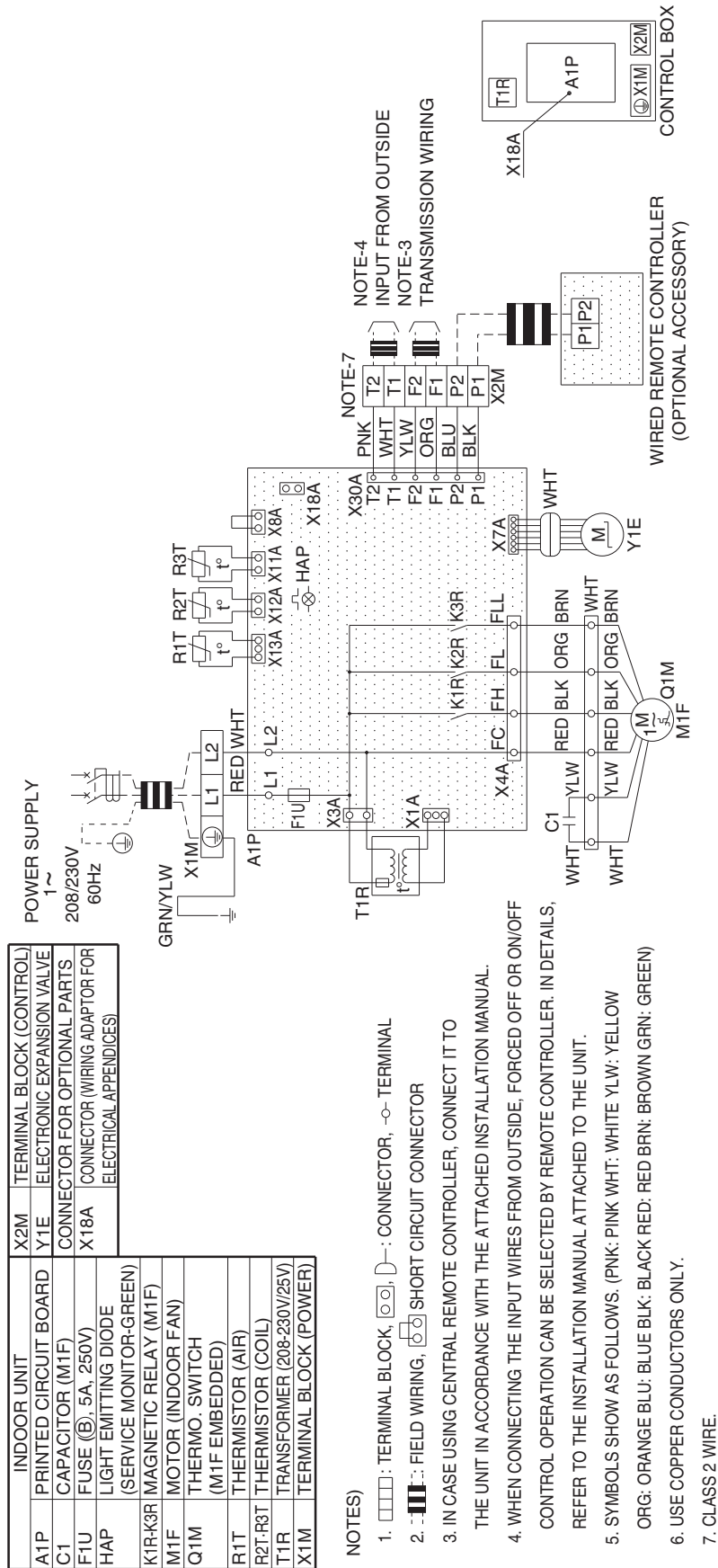

3D045644C



FXTQ09/12/18/24/30/36/42/48/54/60TAVJUA, FXTQ09/12/18/24/30/36/42/48/54/60TAVJUD

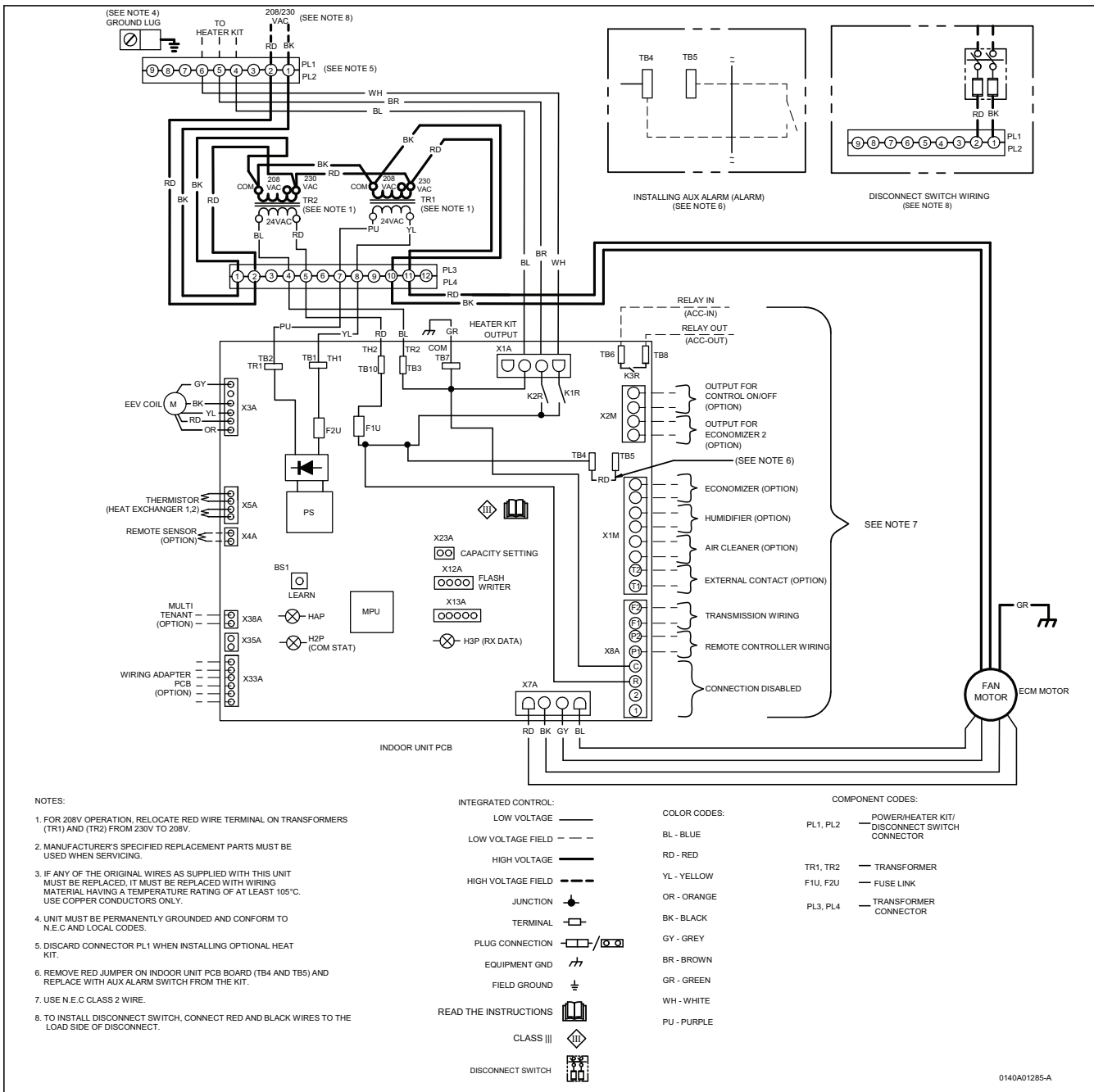

NOTES:

1. FOR 208V OPERATION, RELOCATE RED WIRE TERMINAL ON TRANSFORMERS (TR1) AND (TR2) FROM 230V TO 208V.
2. MANUFACTURER'S SPECIFIED REPLACEMENT PARTS MUST BE USED WHEN SERVICING.
3. IF ANY OF THE ORIGINAL WIRES AS SUPPLIED WITH THIS UNIT MUST BE REPLACED, IT MUST BE REPLACED WITH WIRING MATERIAL HAVING A TEMPERATURE RATING OF AT LEAST 105°C. USE COPPER CONDUCTORS ONLY.
4. UNIT MUST BE PERMANENTLY GROUNDED AND CONFORM TO N.E.C AND LOCAL CODES.
5. DISCARD CONNECTOR PL1 WHEN INSTALLING OPTIONAL HEAT KIT.
6. REMOVE RED JUMPER ON INDOOR UNIT PCB BOARD (TB4 AND TB5) AND REPLACE WITH AUX ALARM SWITCH FROM THE KIT.
7. USE N.E.C CLASS 2 WIRE.
8. TO INSTALL DISCONNECT SWITCH, CONNECT RED AND BLACK WIRES TO THE LOAD SIDE OF DISCONNECT.

INTEGRATED CONTROL:

- LOW VOLTAGE ———
- LOW VOLTAGE FIELD - - - -
- HIGH VOLTAGE ———
- HIGH VOLTAGE FIELD - - - -
- JUNCTION —●—
- TERMINAL —□—
- PLUG CONNECTION —□—/□□
- EQUIPMENT GND —⎓—
- FIELD GROUND —⊥—
- READ THE INSTRUCTIONS —📖—
- CLASS III —⚡—
- DISCONNECT SWITCH —🔌—

COLOR CODES:

- BL - BLUE
- RD - RED
- YL - YELLOW
- OR - ORANGE
- BK - BLACK
- GY - GREY
- BR - BROWN
- GR - GREEN
- WH - WHITE
- PU - PURPLE

COMPONENT CODES:

- PL1, PL2 — POWER/HEATER KIT/ DISCONNECT SWITCH CONNECTOR
- TR1, TR2 — TRANSFORMER
- F1U, F2U — FUSE LINK
- PL3, PL4 — TRANSFORMER CONNECTOR

0140A01285-A



FXTQ09/12/18/24/30/36/42/48/54/60TBVJUA, FXTQ09/12/18/24/30/36/42/48/54/60TBVJUD

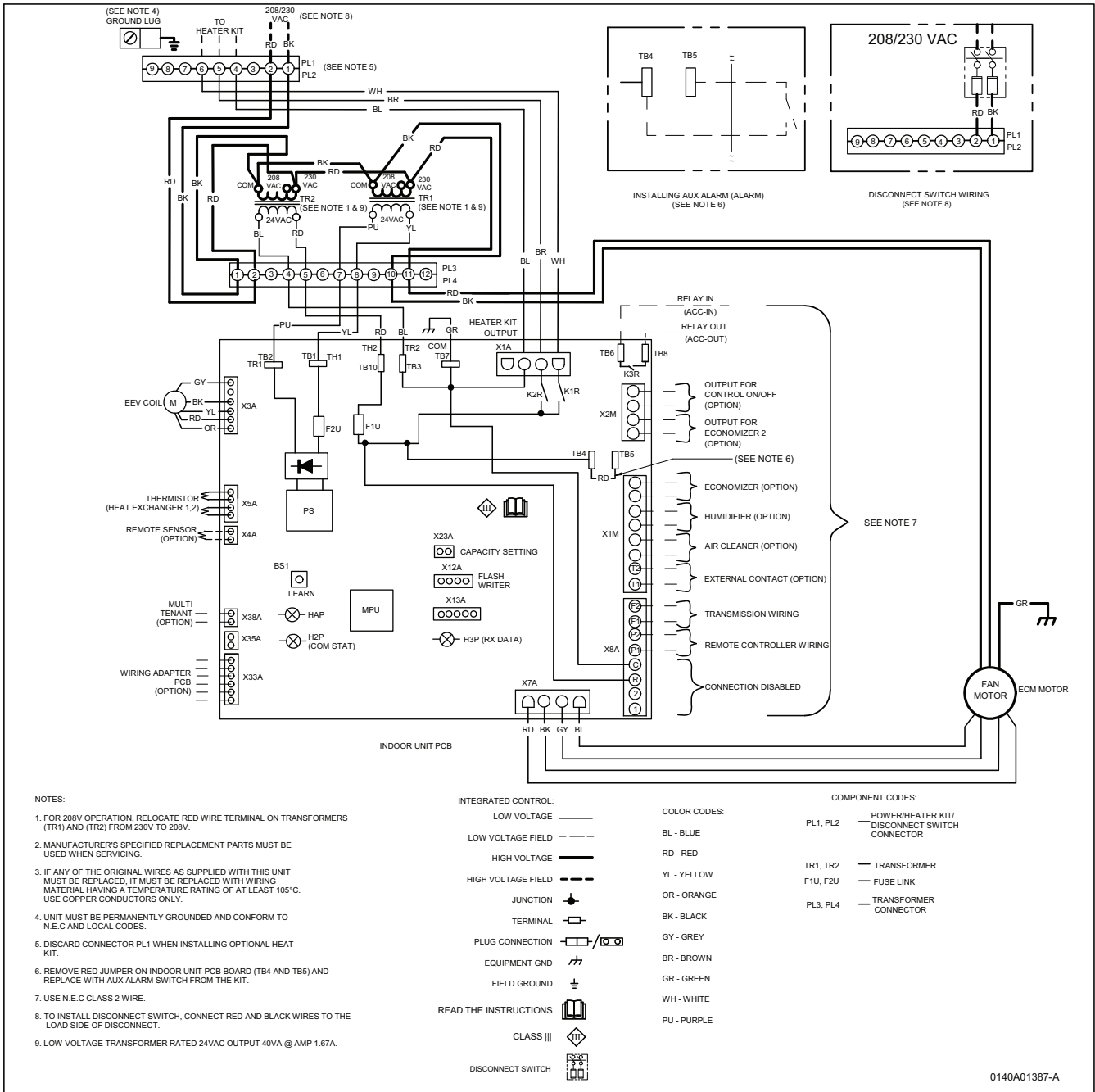

- NOTES:
- FOR 208V OPERATION, RELOCATE RED WIRE TERMINAL ON TRANSFORMERS (TR1) AND (TR2) FROM 230V TO 208V.
  - MANUFACTURER'S SPECIFIED REPLACEMENT PARTS MUST BE USED WHEN SERVICING.
  - IF ANY OF THE ORIGINAL WIRES AS SUPPLIED WITH THIS UNIT MUST BE REPLACED, IT MUST BE REPLACED WITH WIRING MATERIAL HAVING A TEMPERATURE RATING OF AT LEAST 105°C. USE COPPER CONDUCTORS ONLY.
  - UNIT MUST BE PERMANENTLY GROUNDING AND CONFORM TO N.E.C AND LOCAL CODES.
  - DISCARD CONNECTOR PL1 WHEN INSTALLING OPTIONAL HEAT KIT.
  - REMOVE RED JUMPER ON INDOOR UNIT PCB BOARD (TB4 AND TB5) AND REPLACE WITH AUX ALARM SWITCH FROM THE KIT.
  - USE N.E.C CLASS 2 WIRE.
  - TO INSTALL DISCONNECT SWITCH, CONNECT RED AND BLACK WIRES TO THE LOAD SIDE OF DISCONNECT.
  - LOW VOLTAGE TRANSFORMER RATED 24VAC OUTPUT 40VA @ AMP 1.67A.

- INTEGRATED CONTROL:
- LOW VOLTAGE
  - LOW VOLTAGE FIELD
  - HIGH VOLTAGE
  - HIGH VOLTAGE FIELD
  - JUNCTION
  - TERMINAL
  - PLUG CONNECTION
  - EQUIPMENT GND
  - FIELD GROUND
- READ THE INSTRUCTIONS
- CLASS III
- DISCONNECT SWITCH

- COLOR CODES:
- BL - BLUE
  - RD - RED
  - YL - YELLOW
  - OR - ORANGE
  - BK - BLACK
  - GY - GREY
  - BR - BROWN
  - GR - GREEN
  - WH - WHITE
  - PU - PURPLE
- COMPONENT CODES:
- PL1, PL2 POWER/HEATER KIT/ DISCONNECT SWITCH CONNECTOR
  - TR1, TR2 TRANSFORMER
  - F1U, F2U FUSE LINK
  - PL3, PL4 TRANSFORMER CONNECTOR

0140A01387-A

C: 0140A01387A

CXTQ24/36/48/60TASBLU\*

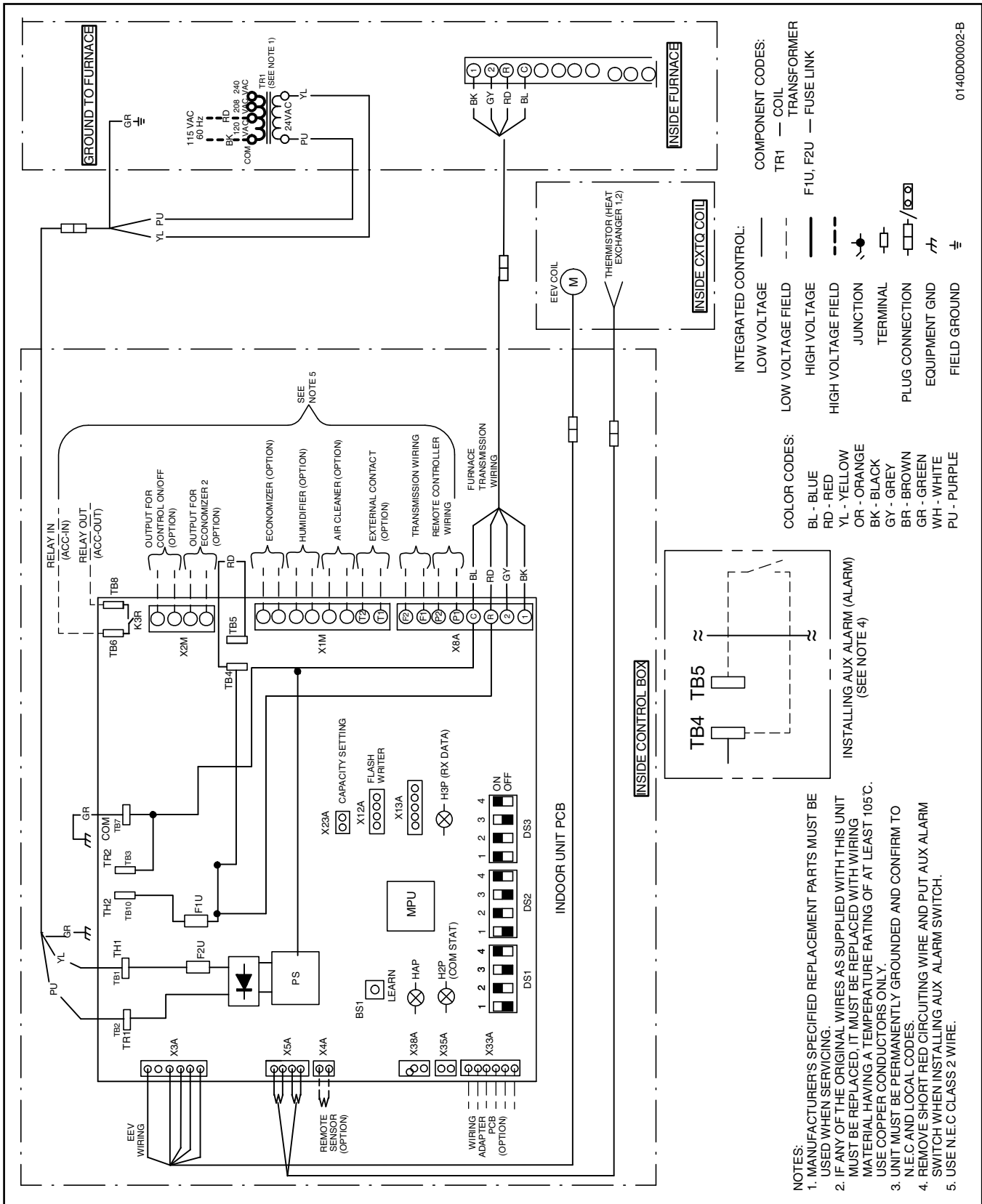

0140D00002-B

# 1.4 Air Treatment Equipment

## 1.4.1 Outdoor-Air Processing Unit

FXMQ48/72/96MFVJU\*

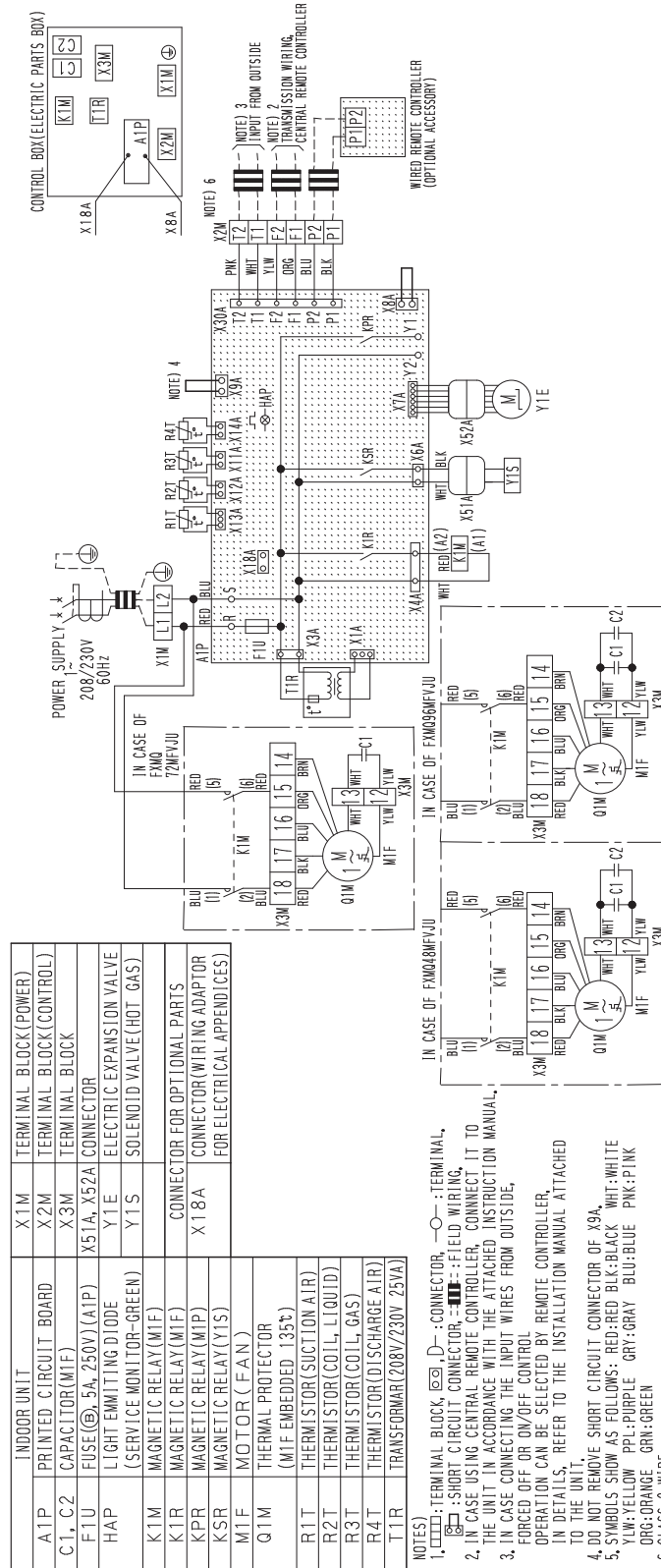

3D065426D

# 1.4.2 Energy Recovery Ventilator (VAM Series)

VAM300/470/600GVJU\*

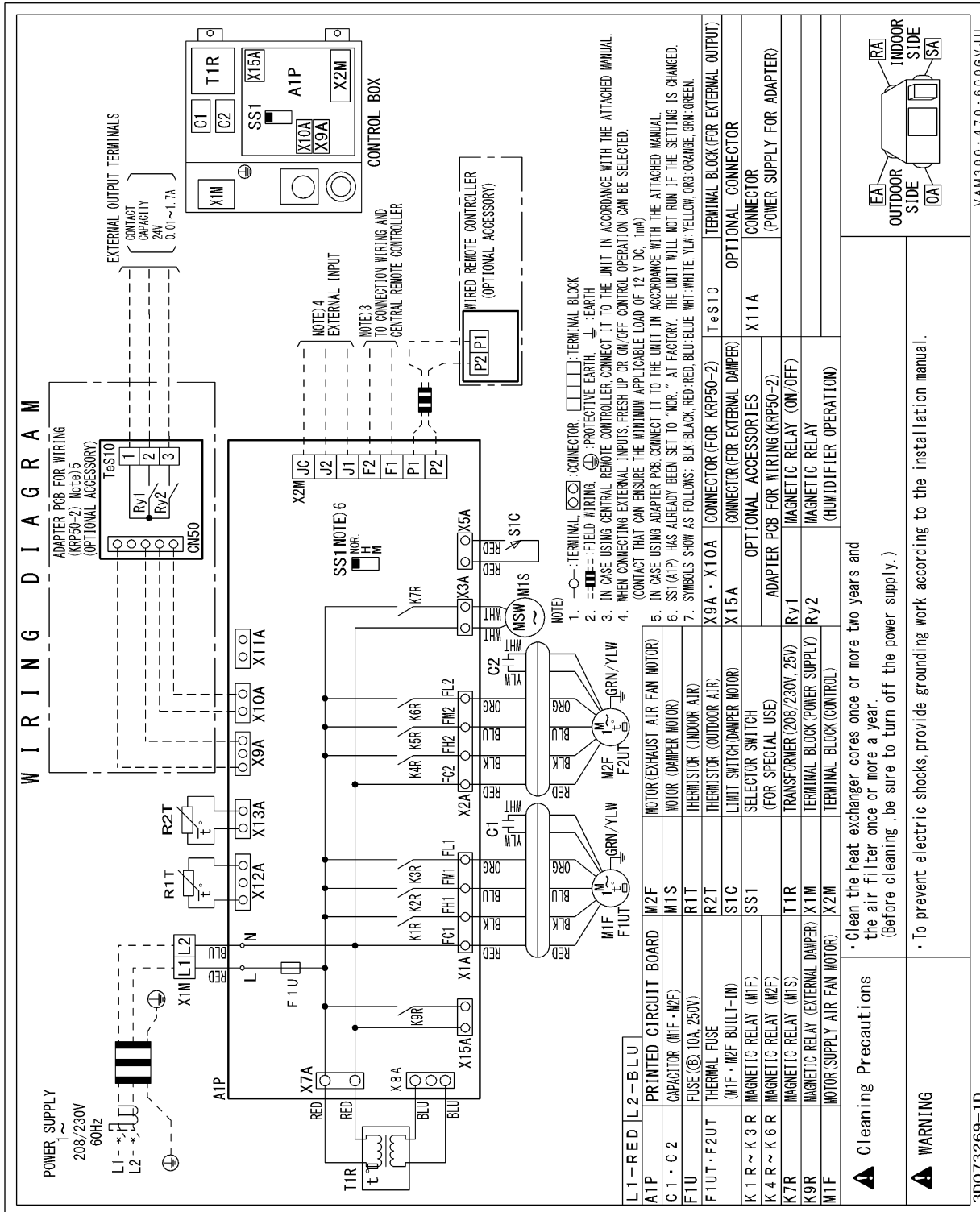

3D073269D

VAM1200GVJU\*

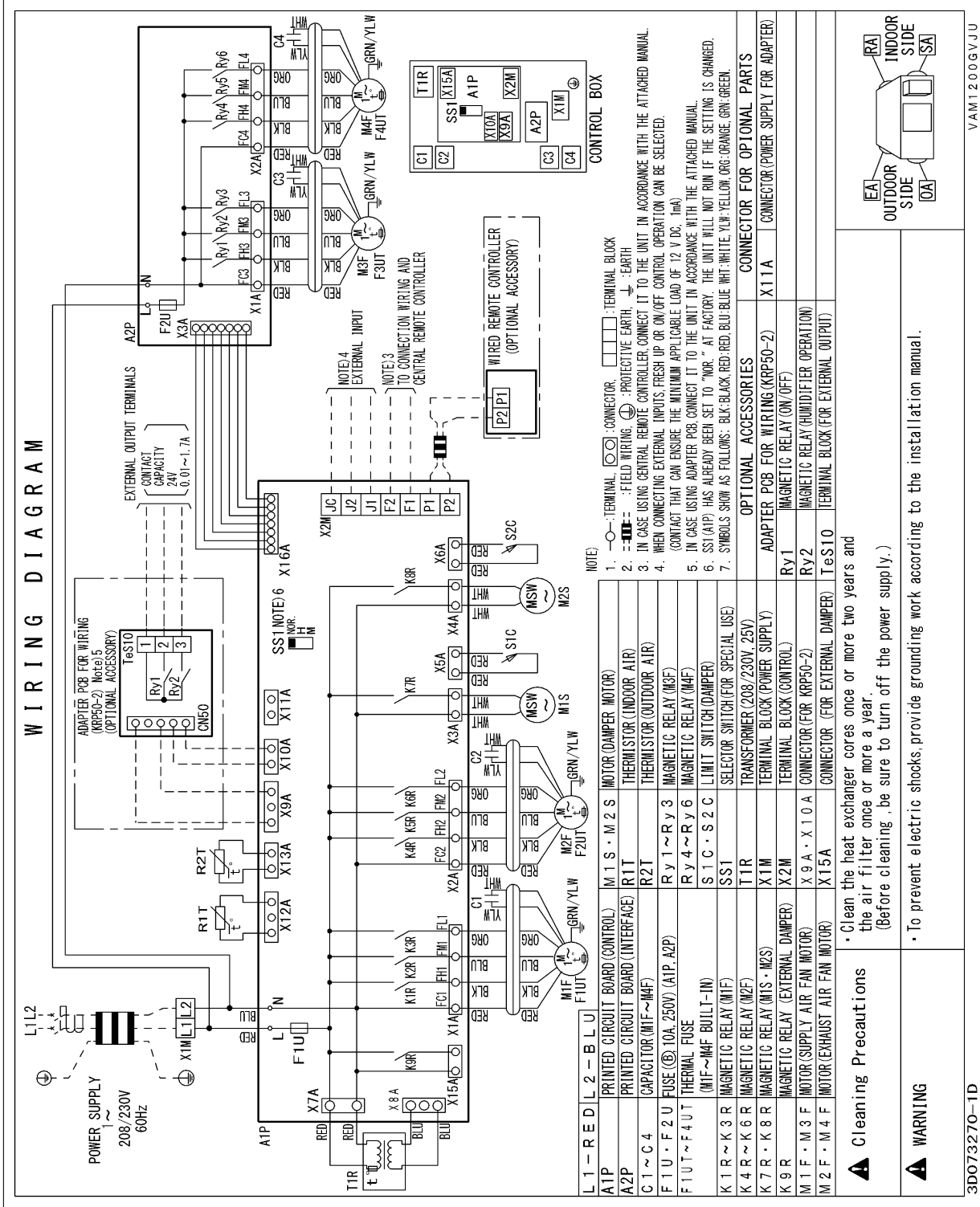

VAM1200GVJU

3D073270D

## 2. Electrical Component Box Removal

1. Remove the screws.

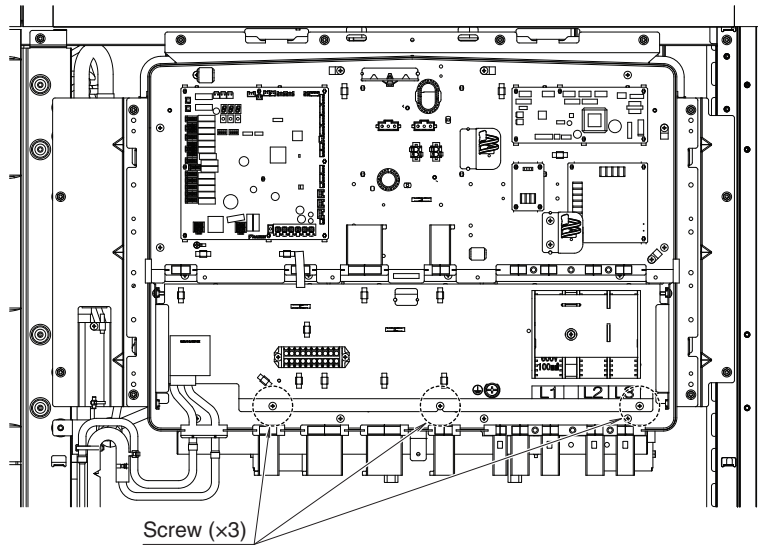

2. Lift the mounting plate up and fasten the hook.

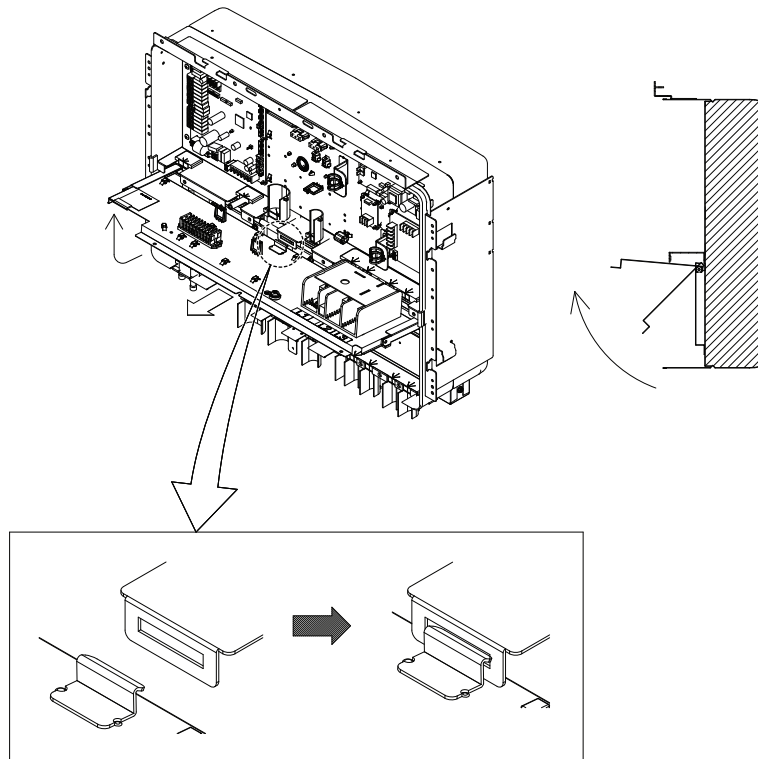

3. Remove the screws.

### 2-compressor Type

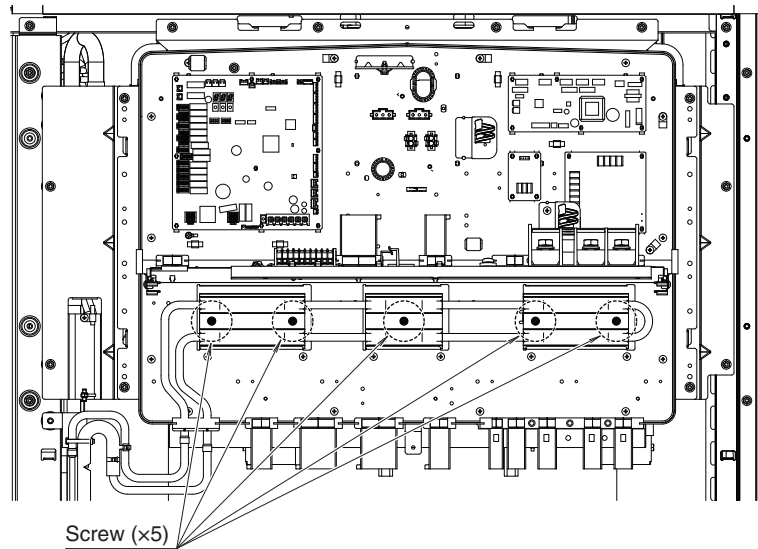

### 1-compressor Type

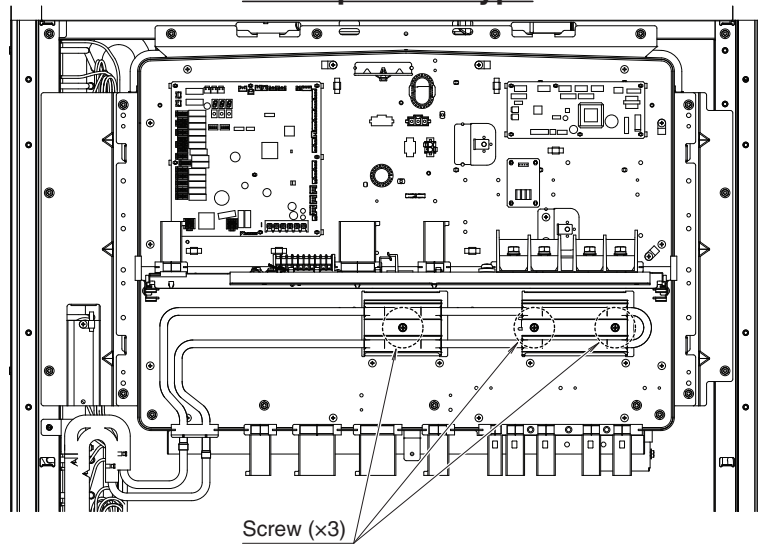

4. Pull out the refrigerant jacket.

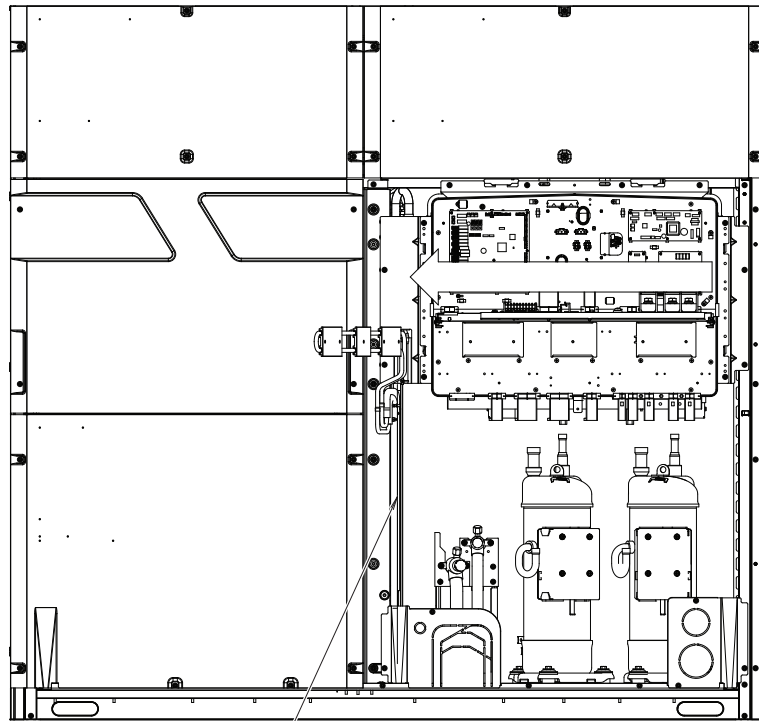
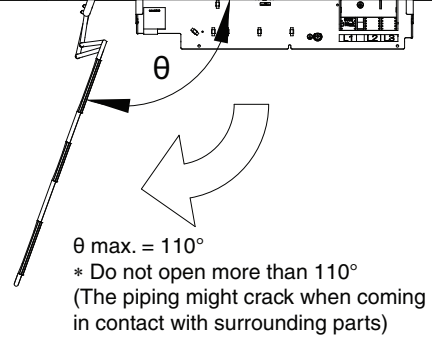
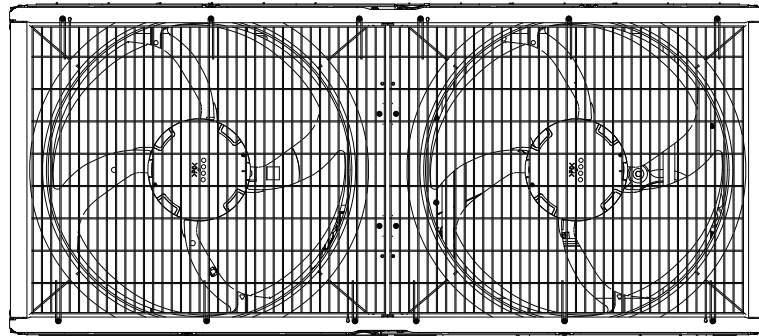

Axis of rotation



5. Remove the screws.

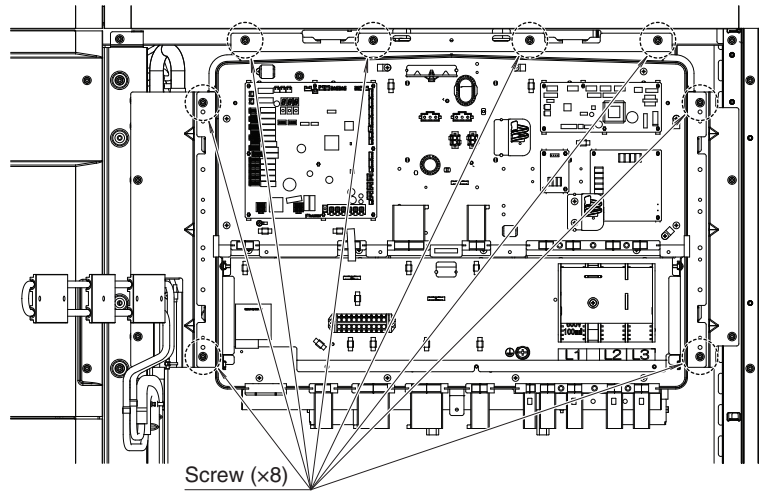

6. Remove the electrical component box.

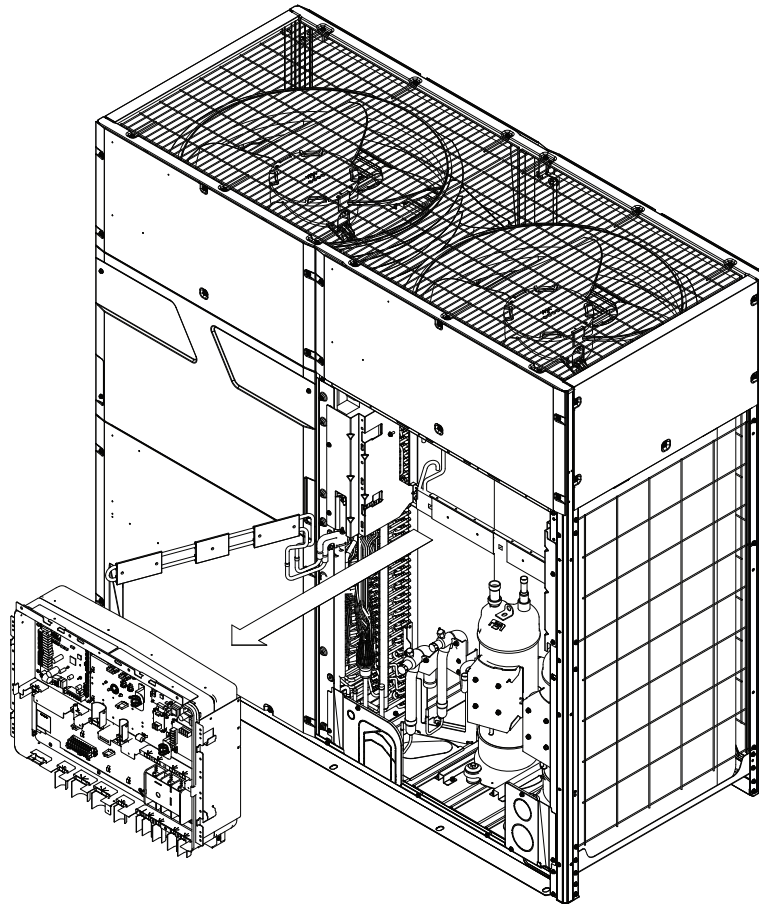

**Warning**



- Daikin products are manufactured for export to numerous countries throughout the world. Prior to purchase, please confirm with your local authorized importer, distributor and/or retailer whether this product conforms to the applicable standards, and is suitable for use, in the region where the product will be used. This statement does not purport to exclude, restrict or modify the application of any local legislation.
- Ask a qualified installer or contractor to install this product. Do not try to install the product yourself. Improper installation can result in water or refrigerant leakage, electrical shock, fire or explosion.
- Use only those parts and accessories supplied or specified by Daikin. Ask a qualified installer or contractor to install those parts and accessories. Use of unauthorized parts and accessories or improper installation of parts and accessories can result in water or refrigerant leakage, electrical shock, fire or explosion.
- Read the user's manual carefully before using this product. The user's manual provides important safety instructions and warnings. Be sure to follow these instructions and warnings.

If you have any inquiries, please contact your local importer, distributor and/or retailer.

### **Cautions on product corrosion**

1. Air conditioners should not be installed in areas where corrosive gases, such as acid gas or alkaline gas, are produced.
2. If the outdoor unit is to be installed close to the sea shore, direct exposure to the sea breeze should be avoided. If you need to install the outdoor unit close to the sea shore, contact your local distributor.

©All rights reserved