

Engineering Data

Design Manual

REYQ-XBTJA, 208 / 230 V

REYQ-XBYDA, 460 V

REYQ-XBYCA, 575 V

Heat Recovery 60 Hz

R-410A



1. Basic Information 5

- 1. Features and Benefits 5
- 2. Compatibility 6
- 3. Nomenclature..... 7
 - 3.1 Outdoor Unit 7
 - 3.2 Indoor Unit..... 8

2. Lineup..... 11

- 1. Model Names 11
 - 1.1 Outdoor Units 11
 - 1.2 Indoor Units 13
 - 1.3 Branch Selector Unit 14
 - 1.4 Air Treatment Equipment 15
 - 1.5 AHU Integration Kit..... 16
- 2. External Appearance 17
 - 2.1 Outdoor Units 17
 - 2.2 Indoor Units 18
 - 2.3 Branch Selector Unit 19
 - 2.4 Air Treatment Equipment 20
 - 2.5 AHU Integration Kit..... 21
- 3. Outdoor Unit Combination 22
- 4. Interchangeability..... 23
- 5. Capacity Range 24
 - 5.1 Connection Ratio..... 24
 - 5.2 Capacity Range of Connectable Indoor Units 25
 - 5.3 Limitation of Capacity Index for Heat Recovery 26

3. Specification 27

- 1. Specifications..... 27
 - 1.1 REYQ-XBTJA..... 27
 - 1.2 REYQ-XBYDA..... 30
 - 1.3 REYQ-XBYCA..... 33
- 2. Dimensions 36
- 3. Service Space..... 39
- 4. Center of Gravity..... 41
- 5. Foundation Drawing..... 43
- 6. Piping Diagrams..... 44
- 7. Wiring Diagrams 46
- 8. Field Wiring..... 56
- 9. Electrical Characteristics..... 59
 - 9.1 REYQ-XBTJA..... 59
 - 9.2 REYQ-XBYDA..... 62
 - 9.3 REYQ-XBYCA..... 65
- 10. Operation Limits..... 68
- 11. Low Ambient Cooling Enhancement..... 69

12. Sound Levels (Reference Data).....	70
13. Accessories.....	75
13.1 Optional Accessories.....	75
14. Selection Procedure.....	76
14.1 Selection Procedure	76
15. Caution Label.....	82
15.1 REYQ-XBTJA / XBYDA / XBYCA	82
16. Caution for Refrigerant Leaks	91
16.1 Introduction.....	91
16.2 Procedure for Checking Maximum Concentration.....	92
17. Safety Devices Setting.....	94
4. Appendix	97
1. Introduction	97
1.1 ED Book List.....	97
1.2 Publication List of Engineering Data for VRV Products.....	98

1. Basic Information

1. Features and Benefits

- Adapting **VRV** to North American market needs
 - Industry's first 3-phase variable refrigerant flow system to integrate with communicating gas furnaces.
 - Design flexibility to enlarge system from single to dual module or dual to triple module without change to installed main pipe sizes**.
 - Engineered to optimize capital on phased and tenant fit out commercial buildings.
 - Choice of gas furnace or heat pump heating for optimizing operational costs based on utility cost.
 - Year round comfort and energy savings with Variable Refrigerant Temperature (VRT) technology.
- Technology that matters
 - Engineered with Daikin's patented vapor injection compressor technology.
 - Corrosion resistant up to 1000† hours Daikin Blue Fin coating as factory standard.
 - Heat exchanger engineered with a bottom refrigerant circuit that allows installation without base pan heater.
 - Refrigerant cooled inverter technology keeps PCB cool independent of ambient temperature.
 - Added peace of mind with ability of Auto changeover to back up (auxiliary) heat.
- Engineered for maintenance
 - New service window provides ease of access to the multi-functional display without removing the main electrical panel.
 - The built-in multi-functional display is utilized for commissioning and maintenance and quickly converts to digital gauges to provide refrigerant pressure and temperatures.
 - Ease of commissioning with ability to program off site and upload using configurator tool.
 - Field performable intermittent outdoor fan operation to help minimize snow accumulation on fan blades when the system is in thermal off.
 - Seamless integration with T-series branch selector boxes, M, P, and T-series indoor units.
 - Compatible with the full suite of Daikin **VRV** controls.
 - Outstanding 10-Year Parts Warranty* as standard.

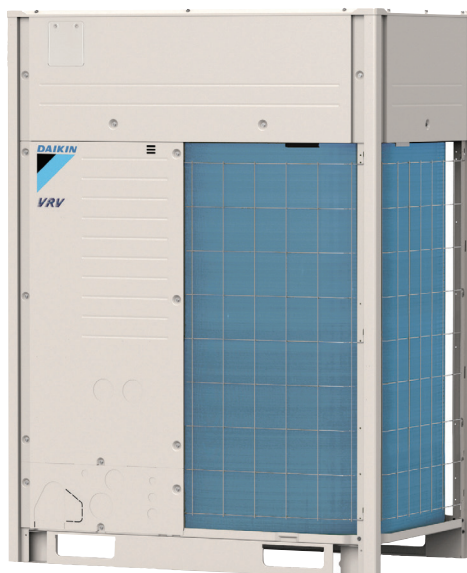

* Complete commercial warranty details available from your local distributor or manufacturer's representative or at www.daikincomfort.com or www.daikinac.com

† When tested in accordance to ASTM B117 methodology.

** Refer to engineering manuals for design rules and pipe sizes.

2. Compatibility

208/230 V model	
New model	Previous model
REYQ72XBTJA	REYQ72XATJB
REYQ96XBTJA	REYQ96XATJB
REYQ120XBTJA	REYQ120XATJB
REYQ144XBTJA	REYQ144XATJB
REYQ168XBTJA	REYQ168XATJB
REYQ192XBTJA	REYQ192XATJB
REYQ216XBTJA	REYQ216XATJB
REYQ240XBTJA	REYQ240XATJB
REYQ264XBTJA	REYQ264XATJB
REYQ288XBTJA	REYQ288XATJB
REYQ312XBTJA	REYQ312XATJB
REYQ336XBTJA	REYQ336XATJB
REYQ360XBTJA	REYQ360XATJB
REYQ384XBTJA	REYQ384XATJB
REYQ408XBTJA	REYQ408XATJB
REYQ432XBTJA	REYQ432XATJB
REYQ456XBTJA	REYQ456XATJB

460 V model	
New model	Previous model
REYQ72XBYDA	REYQ72XAYDB
REYQ96XBYDA	REYQ96XAYDB
REYQ120XBYDA	REYQ120XAYDB
REYQ144XBYDA	REYQ144XAYDB
REYQ168XBYDA	REYQ168XAYDB
REYQ192XBYDA	REYQ192XAYDB
REYQ216XBYDA	REYQ216XAYDB
REYQ240XBYDA	REYQ240XAYDB
REYQ264XBYDA	REYQ264XAYDB
REYQ288XBYDA	REYQ288XAYDB
REYQ312XBYDA	REYQ312XAYDB
REYQ336XBYDA	REYQ336XAYDB
REYQ360XBYDA	REYQ360XAYDB
REYQ384XBYDA	REYQ384XAYDB
REYQ408XBYDA	REYQ408XAYDB
REYQ432XBYDA	REYQ432XAYDB
REYQ456XBYDA	REYQ456XAYDB

575 V model	
New model	Previous model
REYQ72XBYCA	REYQ72XAYCB
REYQ96XBYCA	REYQ96XAYCB
REYQ120XBYCA	REYQ120XAYCB
REYQ144XBYCA	REYQ144XAYCB
REYQ168XBYCA	REYQ168XAYCB
REYQ192XBYCA	REYQ192XAYCB
REYQ216XBYCA	REYQ216XAYCB
REYQ240XBYCA	REYQ240XAYCB
REYQ264XBYCA	REYQ264XAYCB
REYQ288XBYCA	REYQ288XAYCB
REYQ312XBYCA	REYQ312XAYCB
REYQ336XBYCA	REYQ336XAYCB
REYQ360XBYCA	REYQ360XAYCB
REYQ384XBYCA	REYQ384XAYCB
REYQ408XBYCA	REYQ408XAYCB
REYQ432XBYCA	REYQ432XAYCB

3. Nomenclature

3.1 Outdoor Unit

Outdoor Unit

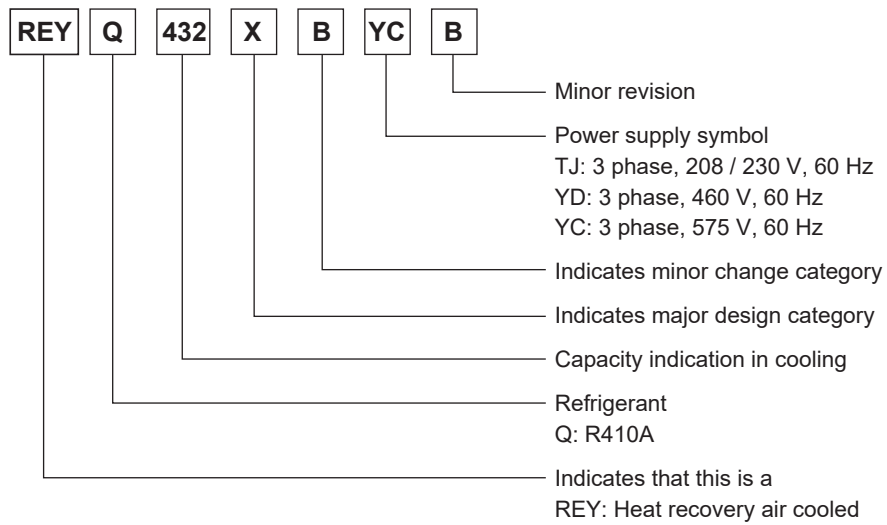

3.2 Indoor Unit

Indoor Unit

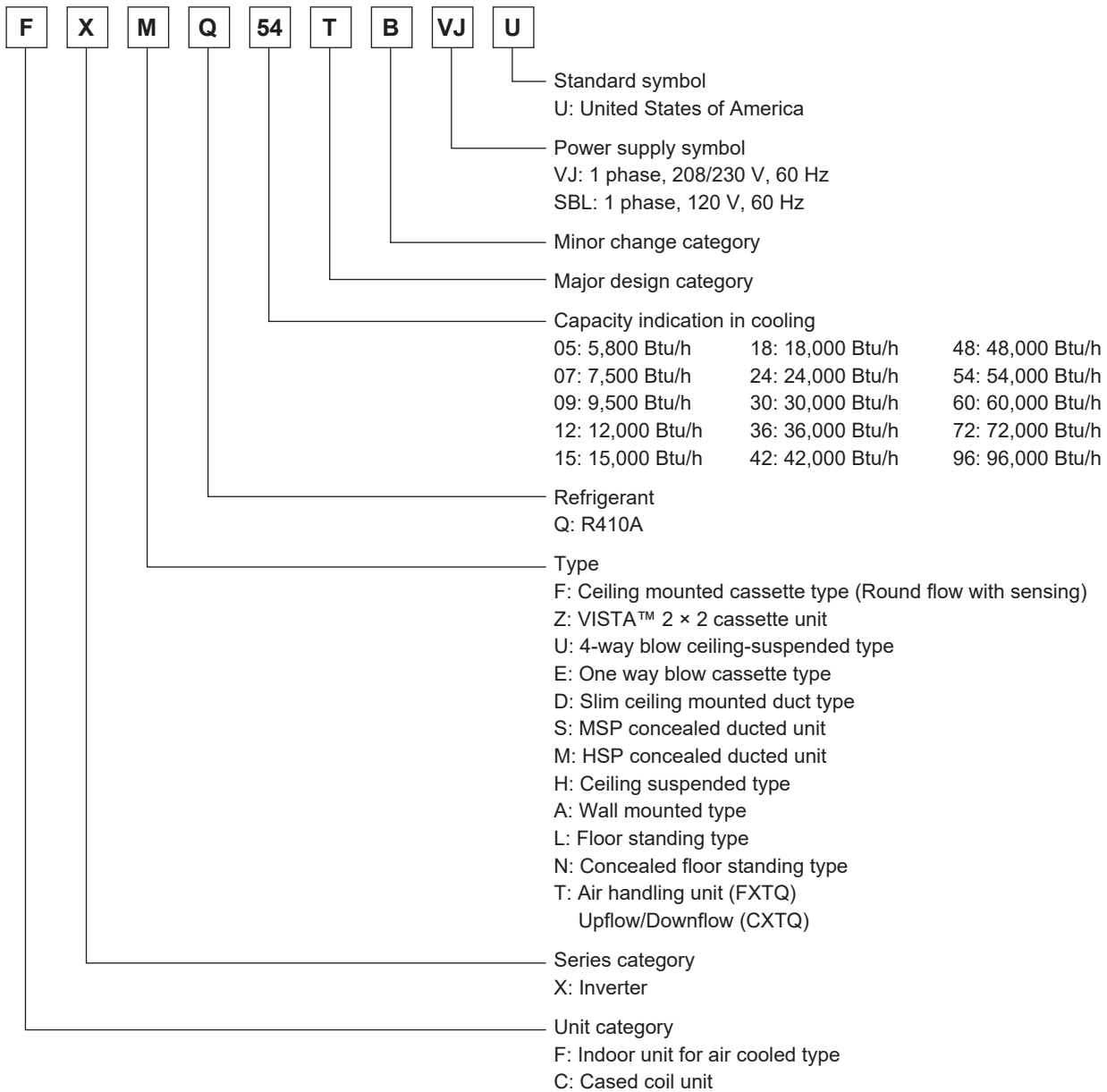

Single Branch Selector unit

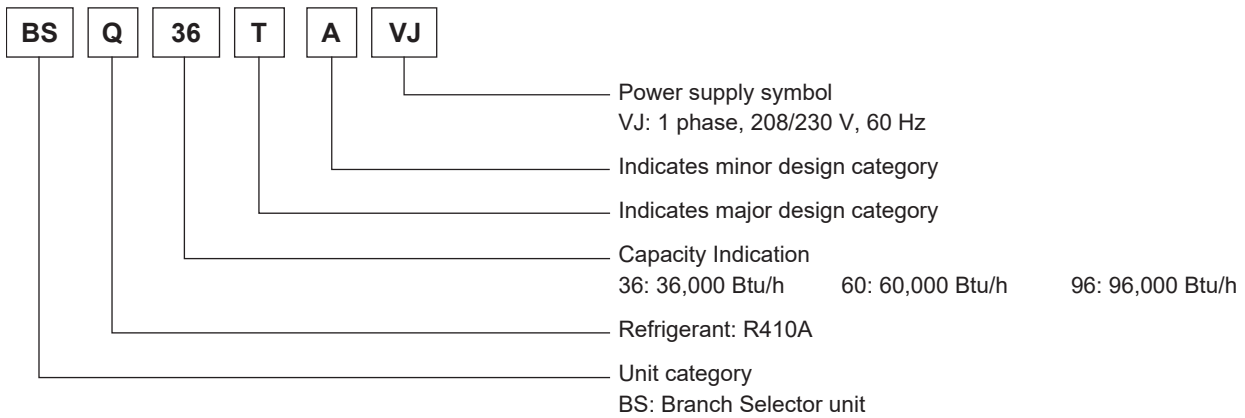

Multi Branch Selector unit (Flex series)

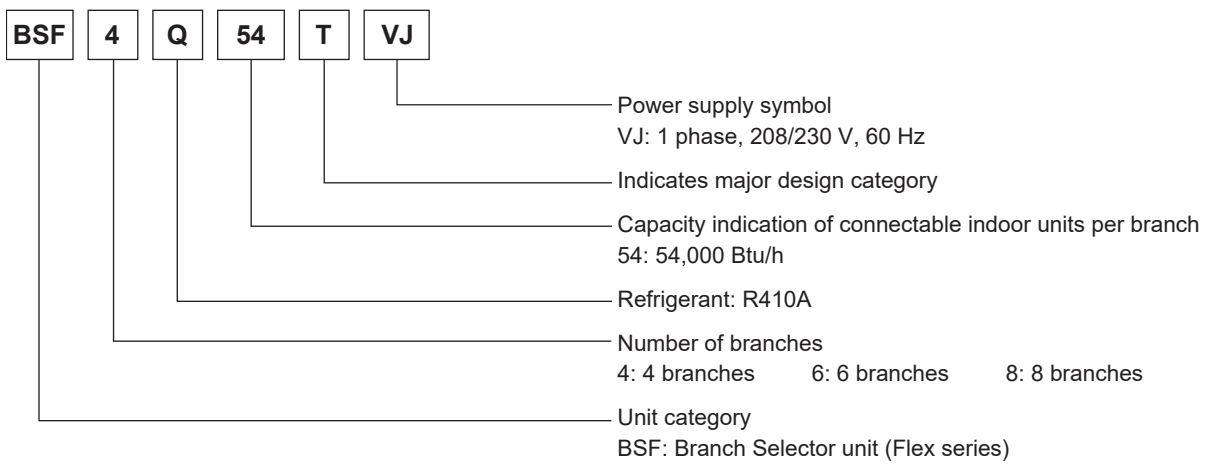

Multi Branch Selector unit (Standard series)

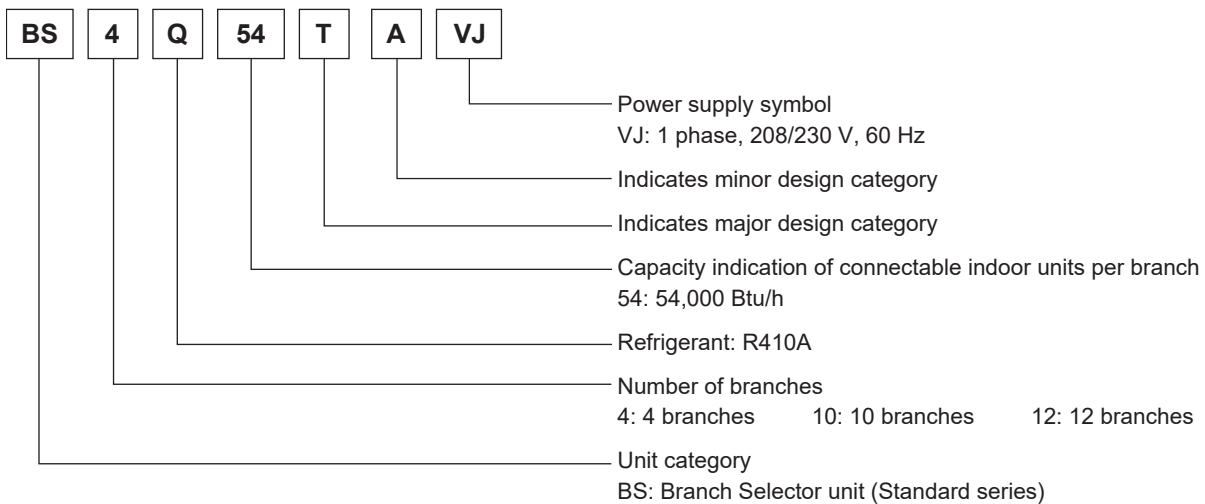

Air Treatment Equipment

Outdoor Air Processing Unit

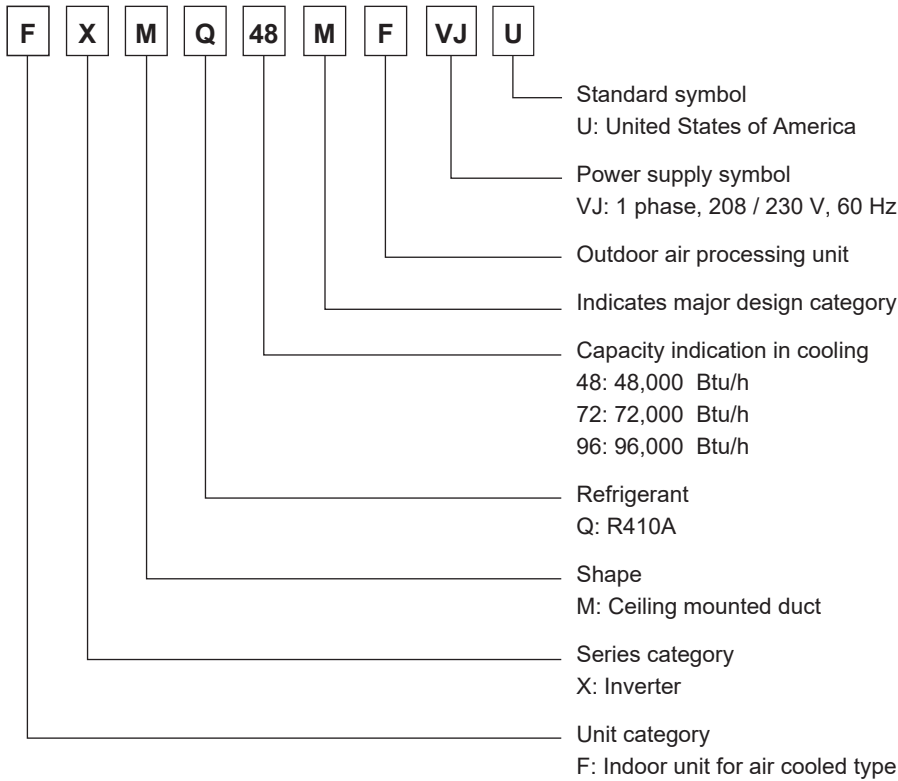

Energy Recovery Ventilator (VAM series)

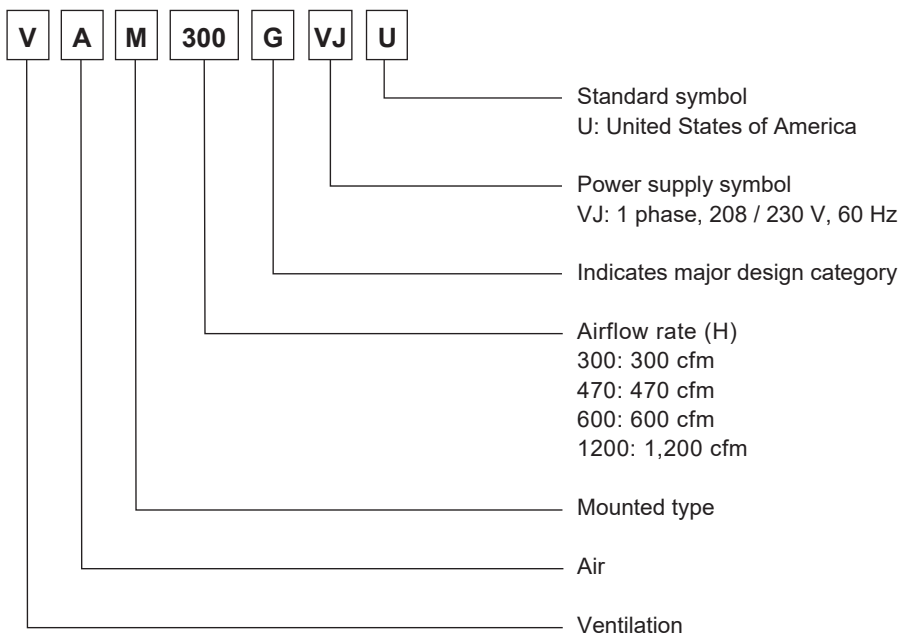

2. Lineup

1. Model Names

1.1 Outdoor Units

Capacity range			6 ton	8 ton	10 ton	12 ton	14 ton	16 ton	18 ton	20 ton	Power supply, Standard
Capacity index			72	96	120	144	168	192	216	240	
Heat recovery	208 / 230 V	REYQ	72XB	96XB	120XB	144XB	168XB	192XB	216XB	240XB	TJA
Heat recovery	460 V	REYQ	72XB	96XB	120XB	144XB	168XB	192XB	216XB	240XB	YDA
Heat recovery	575 V	REYQ	72XB	96XB	120XB	144XB	168XB	192XB	216XB	240XB	YCA

Capacity range			22 ton	24 ton	26 ton	28 ton	30 ton	32 ton	34 ton	36 ton *	38 ton	Power supply, Standard
Capacity index			264	288	312	336	360	384	408	432	456	
Heat recovery	208 / 230 V	REYQ	264XB	288XB	312XB	336XB	360XB	384XB	408XB	432XB	456XB	TJA
Heat recovery	460 V	REYQ	264XB	288XB	312XB	336XB	360XB	384XB	408XB	432XB	456XB	YDA
Heat recovery	575 V	REYQ	264XB	288XB	312XB	336XB	360XB	384XB	408XB	432XB	—	YCA

* 35.5 ton for 575 V units

TJ: 3 phase, 208 / 230 V, 60 Hz

YD: 3 phase, 460 V, 60 Hz

YC: 3 phase, 575 V, 60 Hz

B: Minor revision

Heat Recovery 208 / 230 V

Model name	REYQ72XBTJA	REYQ96XBTJA	REYQ120XBTJA	REYQ144XBTJA	REYQ168XBTJA
Outdoor unit 1	REYQ72XBTJA	REYQ96XBTJA	REYQ120XBTJA	REYQ144XBTJA	REYQ168XBTJA

Model name	REYQ192XBTJA	REYQ216XBTJA	REYQ240XBTJA	REYQ264XBTJA	REYQ288XBTJA	REYQ312XBTJA	REYQ336XBTJA
Outdoor unit 1	REYQ96XBTJA	REYQ96XBTJA	REYQ120XBTJA	REYQ120XBTJA	REYQ144XBTJA	REYQ144XBTJA	REYQ168XBTJA
Outdoor unit 2	REYQ96XBTJA	REYQ120XBTJA	REYQ120XBTJA	REYQ144XBTJA	REYQ144XBTJA	REYQ168XBTJA	REYQ168XBTJA

Model name	REYQ360XBTJA	REYQ384XBTJA	REYQ408XBTJA	REYQ432XBTJA	REYQ456XBTJA
Outdoor unit 1	REYQ120XBTJA	REYQ120XBTJA	REYQ120XBTJA	REYQ144XBTJA	REYQ144XBTJA
Outdoor unit 2	REYQ120XBTJA	REYQ120XBTJA	REYQ144XBTJA	REYQ144XBTJA	REYQ144XBTJA
Outdoor unit 3	REYQ120XBTJA	REYQ144XBTJA	REYQ144XBTJA	REYQ144XBTJA	REYQ168XBTJA

Heat Recovery 460 V

Model name	REYQ72XBYDA	REYQ96XBYDA	REYQ120XBYDA	REYQ144XBYDA	REYQ168XBYDA
Outdoor unit 1	REYQ72XBYDA	REYQ96XBYDA	REYQ120XBYDA	REYQ144XBYDA	REYQ168XBYDA

Model name	REYQ192XBYDA	REYQ216XBYDA	REYQ240XBYDA	REYQ264XBYDA	REYQ288XBYDA	REYQ312XBYDA	REYQ336XBYDA
Outdoor unit 1	REYQ96XBYDA	REYQ96XBYDA	REYQ120XBYDA	REYQ120XBYDA	REYQ144XBYDA	REYQ144XBYDA	REYQ168XBYDA
Outdoor unit 2	REYQ96XBYDA	REYQ120XBYDA	REYQ120XBYDA	REYQ144XBYDA	REYQ144XBYDA	REYQ168XBYDA	REYQ168XBYDA

Model name	REYQ360XBYDA	REYQ384XBYDA	REYQ408XBYDA	REYQ432XBYDA	REYQ456XBYDA
Outdoor unit 1	REYQ120XBYDA	REYQ120XBYDA	REYQ120XBYDA	REYQ144XBYDA	REYQ144XBYDA
Outdoor unit 2	REYQ120XBYDA	REYQ120XBYDA	REYQ144XBYDA	REYQ144XBYDA	REYQ144XBYDA
Outdoor unit 3	REYQ120XBYDA	REYQ144XBYDA	REYQ144XBYDA	REYQ144XBYDA	REYQ168XBYDA

Heat Recovery 575 V

Model name	REYQ72XBYCA	REYQ96XBYCA	REYQ120XBYCA	REYQ144XBYCA	REYQ168XBYCA
Outdoor unit 1	REYQ72XBYCA	REYQ96XBYCA	REYQ120XBYCA	REYQ144XBYCA	REYQ168XBYCA

Model name	REYQ192XBYCA	REYQ216XBYCA	REYQ240XBYCA	REYQ264XBYCA	REYQ288XBYCA	REYQ312XBYCA	REYQ336XBYCA
Outdoor unit 1	REYQ96XBYCA	REYQ96XBYCA	REYQ120XBYCA	REYQ120XBYCA	REYQ144XBYCA	REYQ144XBYCA	REYQ168XBYCA
Outdoor unit 2	REYQ96XBYCA	REYQ120XBYCA	REYQ120XBYCA	REYQ144XBYCA	REYQ144XBYCA	REYQ168XBYCA	REYQ168XBYCA

Model name	REYQ360XBYCA	REYQ384XBYCA	REYQ408XBYCA	REYQ432XBYCA
Outdoor unit 1	REYQ120XBYCA	REYQ120XBYCA	REYQ120XBYCA	REYQ144XBYCA
Outdoor unit 2	REYQ120XBYCA	REYQ120XBYCA	REYQ144XBYCA	REYQ144XBYCA
Outdoor unit 3	REYQ120XBYCA	REYQ144XBYCA	REYQ144XBYCA	REYQ144XBYCA

1.2 Indoor Units

Capacity Range		0.5 ton	0.6 ton	0.8 ton	1 ton	1.25 ton	1.5 ton		2 ton	2.5 ton	3 ton	3.5 ton	4 ton	4.5 ton	5 ton	6 ton	8 ton	Power Supply, Standard
Capacity Index		5.8	7.5	9.5	12	15	18	20	24	30	36	42	48	54	60	72	96	
Ceiling mounted cassette (Round flow with sensing) type	FXFQ	—	07AA	09AA	12AA	15AA	18AA	—	24AA	30AA	36AA	—	48AA	54AA	—	—	—	VJU
VISTA™ 2 × 2 cassette unit	FXZQ	05TB	07TB	09TB	12TB	15TB	18TB	—	—	—	—	—	—	—	—	—	—	
4-way blow ceiling-suspended type	FXUQ	—	—	—	—	—	—	18PA	24PA	30PA	36PA	—	—	—	—	—	—	
One way blow cassette type	FXEQ	—	07P	09P	12P	15P	18P	—	24P	—	—	—	—	—	—	—	—	
Slim ceiling mounted duct type	FXDQ	—	07M	09M	12M	—	18M	—	24M	—	—	—	—	—	—	—	—	
MSP concealed ducted unit	FXSQ	05TB	07TB	09TB	12TB	15TB	18TB	—	24TB	30TB	36TB	—	48TB	54TB	—	—	—	
HSP concealed ducted unit	FXMQ	—	—	—	—	15TB	18TB	—	24TB	30TB	36TB	—	48TB	54TB	—	—	—	
Ceiling mounted duct type	FXMQ	—	—	—	—	—	—	—	—	—	—	—	—	—	—	72TA	96TA	
Ceiling suspended type	FXHQ	—	—	—	12M	—	—	—	24M	—	36M	—	—	—	—	—	—	
Wall mounted type	FXAQ	—	07P	09P	12P	—	18P	—	24P	—	—	—	—	—	—	—	—	
Floor standing type	FXLQ	—	07M	09M	12M	—	18M	—	24M	—	—	—	—	—	—	—	—	
Concealed floor standing type	FXNQ	—	07M	09M	12M	—	18M	—	24M	—	—	—	—	—	—	—	—	
Air handling unit	FXTQ	—	—	09TB	12TB	—	18TB	—	24TB	30TB	36TB	42TB	48TB	54TB	60TB	—	—	
		—	—	09TB	12TB	—	18TB	—	24TB	30TB	36TB	42TB	48TB	54TB	60TB	—	—	VJUD
Cased coil unit	CXTQ	—	—	—	—	—	—	—	24TA	—	36TA	—	48TA	—	60TA	—	—	SBLU
Low-temperature hydrobox	HXY	—	—	—	—	—	—	—	—	—	—	—	48T	—	—	—	—	VJU

2. Lineup

1.3 Branch Selector Unit

Single Branch Selector Unit

Series		Model name			Power supply, standard
Heat recovery	BSQ	36T	60T	96T	VJ

Note:

No interchangeability between BSVQ-PVJU and BSQ-TAVJ.

VJ: 1 phase, 208/230 V, 60 Hz

Multi Branch Selector Unit

Flex Series

Series		Model name			Power supply, standard
Heat recovery	BSF	4Q54T	6Q54T	8Q54T	VJ

Note:

No interchangeability between BSV-Q36PVJU and BSF-Q54TVJ.

VJ: 1 phase, 208/230 V, 60 Hz

Standard Series

Series		Model name			Power supply, standard
Heat recovery	BS	4Q54T	10Q54T	12Q54T	VJ

Note:

No interchangeability between BSV-Q36PVJU and BS-Q54TAVJ.

VJ: 1 phase, 208/230 V, 60 Hz

1.4 Air Treatment Equipment

Outdoor Air Processing Unit

Series	Model name			Power supply, Standard
FXMQ	48MF	72MF	96MF	VJU

VJ: 1 phase, 208 / 230 V, 60 Hz
 U(VJU): Standard symbol

Energy Recovery Ventilator (VAM series)

Series	Model name				Power supply, Standard
VAM	300G	470G	600G	1200G	VJU

VJ: 1 phase, 208 / 230 V, 60 Hz
 U(VJU): Standard symbol

1.5 AHU Integration Kit

Series	Model name	Power supply, Standard
Re-Heat	EKEQDCBAV3-US	VJU

VJ: 1 phase, 208 / 230 V, 60 Hz

U(VJU): Standard symbol

2. External Appearance

2.1 Outdoor Units

Single Outdoor Units

REYQ72XBTJA REYQ144XBTJA REYQ96XBTJA REYQ168XBTJA REYQ120XBTJA	REYQ72XBYDA REYQ144XBYDA REYQ96XBYDA REYQ168XBYDA REYQ120XBYDA	REYQ72XBYCA REYQ144XBYCA REYQ96XBYCA REYQ168XBYCA REYQ120XBYCA
--	--	--

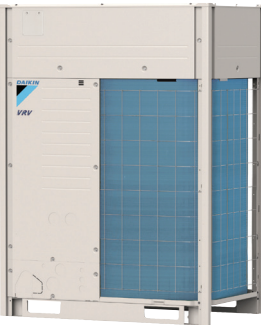

6, 8, 10, 12, 14 ton

Double Outdoor Units

REYQ192XBTJA REYQ288XBTJA REYQ216XBTJA REYQ312XBTJA REYQ240XBTJA REYQ336XBTJA REYQ264XBTJA	REYQ192XBYDA REYQ288XBYDA REYQ216XBYDA REYQ312XBYDA REYQ240XBYDA REYQ336XBYDA REYQ264XBYDA	REYQ192XBYCA REYQ288XBYCA REYQ216XBYCA REYQ312XBYCA REYQ240XBYCA REYQ336XBYCA REYQ264XBYCA
---	---	---



16, 18, 20, 22, 24, 26, 28 ton

Triple Outdoor Units

REYQ360XBTJA REYQ432XBTJA REYQ384XBTJA REYQ456XBTJA REYQ408XBTJA	REYQ360XBYDA REYQ432XBYDA REYQ384XBYDA REYQ456XBYDA REYQ408XBYDA	REYQ360XBYCA REYQ432XBYCA REYQ384XBYCA REYQ408XBYCA
--	--	---

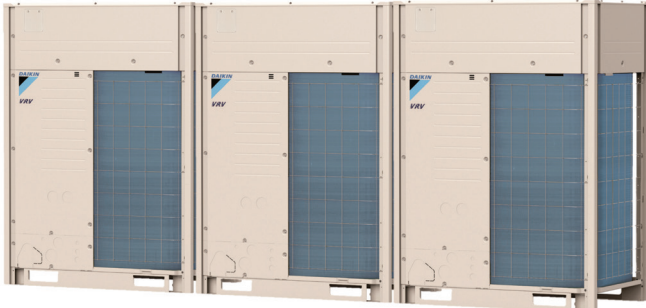

30, 32, 34, 36 *, 38 ton

* 35.5 ton for 575 V units

2. Lineup

2.2 Indoor Units

<p>Ceiling mounted cassette (Round flow with sensing) type FXFQ-AA</p>  <p>Shown with BYCQ54EEFU</p>	<p>Ceiling suspended type FXHQ-M</p> 
<p>VISTA™ 2 × 2 cassette unit FXZQ-TB</p> 	<p>Wall mounted type FXAQ-P</p> 
<p>4-way blow ceiling-suspended type FXUQ-PA</p> 	<p>Floor standing type FXLQ-M</p> 
<p>One way blow cassette type FXEQ-P</p> 	<p>Concealed floor standing type FXNQ-M</p> 
<p>Slim ceiling mounted duct type FXDQ-M</p> 	<p>Air handling unit FXTQ-TB</p> 
<p>MSP concealed ducted unit FXSQ-TB</p> 	<p>Cased coil unit CXTQ-TA</p> 
<p>HSP concealed ducted unit FXMQ-TB</p> 	<p>Low-temperature hydrobox HXY-TA</p> 
<p>Ceiling mounted duct type FXMQ-TA</p> 	

2.3 Branch Selector Unit

Single Branch Selector Unit

Single port

BSQ36T
BSQ60T
BSQ96T

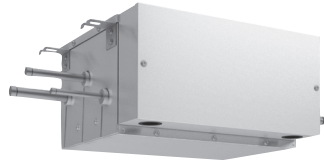

Multi Branch Selector Unit

Flex Series

BSF4Q54T

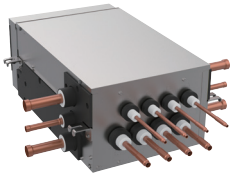

BSF6Q54T



BSF8Q54T

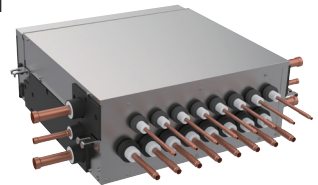

Standard Series

BS4Q54T

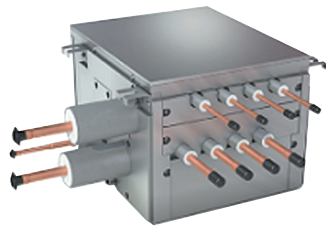

BS10Q54T
BS12Q54T



2.4 Air Treatment Equipment

Outdoor air processing unit

FXMQ-MF



Energy recovery ventilator
(VAM series)

VAM-G

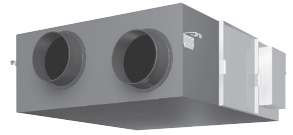

2.5 AHU Integration Kit

AHU Integration Kit - Re-Heat

EKEQDCBAV3-US



3. Outdoor Unit Combination

Model name	System capacity			Number of units	Module					Outdoor unit multi connection piping kit *1
	Ton	HP	kW		72	96	120	144	168	
REYQ72XBTJA REYQ72XBYDA REYQ72XBYCA	6	7.5	21.1	1	●					—
REYQ96XBTJA REYQ96XBYDA REYQ96XBYCA	8	10.0	28.1	1		●				
REYQ120XBTJA REYQ120XBYDA REYQ120XBYCA	10	12.5	35.2	1			●			
REYQ144XBTJA REYQ144XBYDA REYQ144XBYCA	12	15.0	42.2	1				●		
REYQ168XBTJA REYQ168XBYDA REYQ168XBYCA	14	17.5	49.2	1					●	
REYQ192XBTJA REYQ192XBYDA REYQ192XBYCA	16	20.0	56.3	2		●●				BHFP26P100U BHFP26P100UA
REYQ216XBTJA REYQ216XBYDA REYQ216XBYCA	18	22.5	63.3	2		●	●			
REYQ240XBTJA REYQ240XBYDA REYQ240XBYCA	20	25.0	70.3	2			●●			
REYQ264XBTJA REYQ264XBYDA REYQ264XBYCA	22	27.5	77.4	2			●	●		
REYQ288XBTJA REYQ288XBYDA REYQ288XBYCA	24	30.0	84.4	2				●●		
REYQ312XBTJA REYQ312XBYDA REYQ312XBYCA	26	32.5	91.4	2				●	●	
REYQ336XBTJA REYQ336XBYDA REYQ336XBYCA	28	35.0	98.5	2					●●	
REYQ360XBTJA REYQ360XBYDA REYQ360XBYCA	30	37.5	105.5	3			●●●			BHFP26P151U BHFP26P151UA
REYQ384XBTJA REYQ384XBYDA REYQ384XBYCA	32	40.0	112.5	3			●●	●		
REYQ408XBTJA REYQ408XBYDA REYQ408XBYCA	34	42.5	119.6	3			●	●●		
REYQ432XBTJA REYQ432XBYDA REYQ432XBYCA	36 *2	45.0	126.6	3				●●●		
REYQ456XBTJA REYQ456XBYDA	38	47.5	133.6	3				●●	●	

Note:

*1. For multiple connection, the outdoor unit multi connection piping kit (separately sold) is required.

*2. 35.5 ton for 575 V units

4. Interchangeability

Branch selector unit		T-series branch selector unit			(Reference) P-series branch selector unit	
		Single branch selector unit	Multi branch selector unit		Single branch selector unit	Multi branch selector unit
			Flex series	Standard series		
Outdoor unit		BSQ36T(A)VJ BSQ60T(A)VJ BSQ96T(A)VJ	BSF4Q54TVJ BSF6Q54TVJ BSF8Q54TVJ	BS4Q54T(A)VJ BS6Q54TVJ BS8Q54TVJ BS10Q54T(A)VJ BS12Q54T(A)VJ	BSVQ36PVJU BSVQ60PVJU BSVQ96PVJU	BSV4Q36PVJU BSV6Q36PVJU
Heat recovery	REYQ-XBTJA	Connectable	Connectable	Connectable	Not connectable	Not connectable
	REYQ-XBYDA	Connectable	Connectable	Connectable	Not connectable	Not connectable
	REYQ-XBYCA	Connectable	Connectable	Connectable	Not connectable	Not connectable

Note:

*1. Combination of P-series and T-series of Branch selector units in a single system is not permitted.

Combining the two series may cause malfunction.

*2. BSQ_TAVJ and BSQ_TVJ are compatible and can be mix and match or be used as direct replacement.

*3. BS_Q54TAVJ and BS_Q54TVJ are compatible and can be mix and match or be used as direct replacement.

5. Capacity Range

5.1 Connection Ratio

$\text{Connection ratio} = \frac{\text{Total capacity index of the indoor units}}{\text{Capacity index of the outdoor units}}$
--

Type	Min. connection ratio	Max. connection ratio					
		Types of connected indoor units			Type of connected air treatment		Low-temperature hydrobox *6
		When using only FXDQ, FXMQ-TB, FXAQ, FXSQ07-54T	When using at least one FXZQ05T, FXSQ05T, FXFQ07/09	When using other indoor unit models	When FXMQ-MF is only connected	When FXMQ-MF and indoor units are connected	
Single outdoor units	50% *1	200% *2	180% *2	200% *2	100%	100% *4	130% *5
Double outdoor units			160% *2	160% *2			
Triple outdoor units			130%	130%			

Note:

*1. 70%: REYQ72X type

*2. If the operational capacity of indoor units is more than 130%, low airflow operation is enforced in all the indoor units. This limitation can be deactivated through field setting.

*3. For indoor units used for cooling only (do not connect to Branch selector unit when using for heat recovery), total capacity index of cooling only indoor units must be 50% or less than the total capacity index of the indoor units.

*4. When outdoor-air processing units (FXMQ-MF) and standard indoor units are connected, the total connection capacity of the outdoor-air processing units (FXMQ-MF) must not exceed 30% of the capacity index of the outdoor units. And the connection ratio must not exceed 100%.

*5. When connecting the low-temperature hydrobox, a minimum of 50% of the system connection ratio must be comprised of **VRV** indoor units. This is required to prevent the secondary side water temperature from dropping and to prevent the water from freezing during defrost or ON/OFF of the indoor unit.

*6. Mixed combination of FXMQ-MF and low-temperature hydrobox in the system is not allowed.

*7. Regarding the combinations related to the AHU integration kit (EKEQ), refer to the Engineering data book.

5.2 Capacity Range of Connectable Indoor Units

Type	Ton	Capacity index	Model name	Total capacity index of connectable indoor units *1	Maximum number of connectable indoor units	Maximum number of connectable hydrobox
Single outdoor units	6	72	REYQ72XBTJA REYQ72XBYDA REYQ72XBYCA	51 to 93 (144)	12	1
	8	96	REYQ96XBTJA REYQ96XBYDA REYQ96XBYCA	48 to 124 (192)	16	1
	10	120	REYQ120XBTJA REYQ120XBYDA REYQ120XBYCA	60 to 156 (240)	20	2
	12	144	REYQ144XBTJA REYQ144XBYDA REYQ144XBYCA	72 to 187 (288)	25	2
	14	168	REYQ168XBTJA REYQ168XBYDA REYQ168XBYCA	84 to 218 (336)	29	2
Double outdoor units	16	192	REYQ192XBTJA REYQ192XBYDA REYQ192XBYCA	96 to 249 (307)	33	3
	18	216	REYQ216XBTJA REYQ216XBYDA REYQ216XBYCA	108 to 280 (345)	37	3
	20	240	REYQ240XBTJA REYQ240XBYDA REYQ240XBYCA	120 to 312 (384)	41	4
	22	264	REYQ264XBTJA REYQ264XBYDA REYQ264XBYCA	132 to 343 (422)	45	4
	24	288	REYQ288XBTJA REYQ288XBYDA REYQ288XBYCA	144 to 374 (460)	49	4
	26	312	REYQ312XBTJA REYQ312XBYDA REYQ312XBYCA	156 to 405 (499)	54	5
	28	336	REYQ336XBTJA REYQ336XBYDA REYQ336XBYCA	168 to 436 (537)	58	5
Triple outdoor units	30	360	REYQ360XBTJA REYQ360XBYDA REYQ360XBYCA	180 to 468 (468)	62	6
	32	384	REYQ384XBTJA REYQ384XBYDA REYQ384XBYCA	192 to 499 (499)	64	6
	34	408	REYQ408XBTJA REYQ408XBYDA REYQ408XBYCA	204 to 530 (530)	64	6
	36 *2	432	REYQ432XBTJA REYQ432XBYDA REYQ432XBYCA	216 to 561 (561)	64	7
	38	456	REYQ456XBTJA REYQ456XBYDA	228 to 592 (592)	64	7

Note:

*1. Values inside brackets are based on connection of indoor units rated at maximum capacity, 200% for single outdoor units, 160% for double outdoor units, and 130% for triple outdoor units.

*2. 35.5 ton for 575 V units

*3. Regarding the total capacity index of connectable AHU integration kit (EKEQ) and the maximum number of them, refer to the Engineering data book.

5.3 Limitation of Capacity Index for Heat Recovery

Single Branch Selector Unit

Model	BSQ36T	BSQ60T	BSQ96T
Maximum number of connectable indoor units	4	8	8
Total capacity index of connectable indoor units	unit ≤ 36	36 < unit ≤ 60	60 < unit ≤ 96

Multi Branch Selector Unit

Flex series

Model	BSF4Q54T	BSF6Q54T	BSF8Q54T
Maximum number of connectable indoor units per branch	5	5	5
Number of branches	4	6	8
Maximum capacity index of connectable indoor units per branch (★1)	54 or less	54 or less	54 or less
Series configuration	Maximum number of connectable indoor units	30	30
	Maximum capacity index of connectable indoor units per branch selector unit	144 or less	162 or less
	Maximum capacity index of connectable indoor units with branch selector units connected in series	230 or less	230 or less
Parallel configuration	Maximum number of connectable indoor units	19	28
	Maximum capacity index of connectable indoor units	144 or less	216 or less

Standard series

Model	BS4Q54T	BS10Q54T	BS12Q54T
Maximum number of connectable indoor units	19	38	38
Maximum number of connectable indoor units per branch	5	5	5
Number of branches	4	10	12
Maximum capacity index of connectable indoor units	144 or less	290 or less	290 or less
Maximum capacity index of connectable indoor units per branch (★1)	54 or less	54 or less	54 or less

Note:

- ★1. When the total capacity index of indoor units to be connected downstream is larger than 54 (Max 96), use a joint kit (KHRP26A250T, optional parts) to join two branches downstream from the Branch Selector unit.

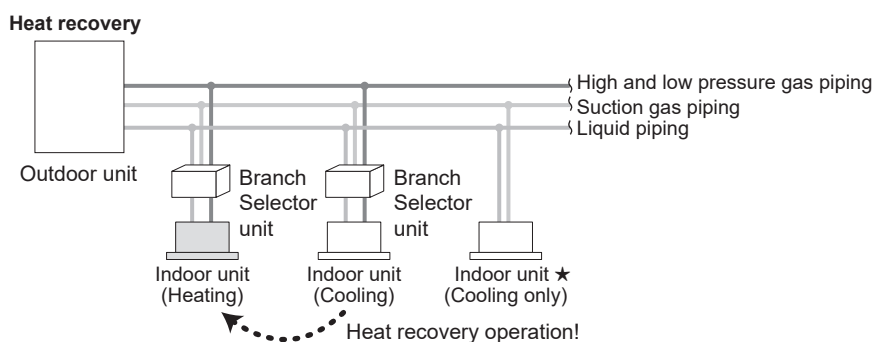

- ★For indoor units used for cooling only (do not connect to Branch Selector unit when using for Heat recovery), total capacity index must be 50% or less than the capacity index of the outdoor units.

3. Specification

1. Specifications

1.1 REYQ-XBTJA

REYQ72 - 168XBTJA

Outdoor Unit Model No.	REYQ72XBTJA	REYQ96XBTJA	REYQ120XBTJA	REYQ144XBTJA	REYQ168XBTJA
Power Supply	3 phase, 60Hz, 208/230V	3 phase, 60Hz, 208/230V	3 phase, 60Hz, 208/230V	3 phase, 60Hz, 208/230V	3 phase, 60Hz, 208/230V
*1 Cooling Capacity	Nominal	72,000 (21.1)	96,000 (28.1)	119,000 (34.9)	Nominal
	Rated	69,000 (20.2)	92,000 (27.0)	114,000 (33.4)	Rated
*2 Heating Capacity	Nominal	81,000 (23.7)	108,000 (31.7)	135,000 (39.6)	Nominal
	Rated	69,000 (20.2)	92,000 (27.0)	114,000 (33.4)	Rated
Casing Color	Ivory White (5Y7.5/1)	Ivory White (5Y7.5/1)	Ivory White (5Y7.5/1)	Ivory White (5Y7.5/1)	Ivory White (5Y7.5/1)
Dimensions: (H x W x D)	66-11/16 x 48-7/8 x 30-3/16 (1694 x 1242 x 767)	66-11/16 x 48-7/8 x 30-3/16 (1694 x 1242 x 767)	66-11/16 x 48-7/8 x 30-3/16 (1694 x 1242 x 767)	66-11/16 x 48-7/8 x 30-3/16 (1694 x 1242 x 767)	66-11/16 x 48-7/8 x 30-3/16 (1694 x 1242 x 767)
Heat Exchanger	Cross Fin Coil	Cross Fin Coil	Cross Fin Coil	Cross Fin Coil	Cross Fin Coil
Compressor	Type	Hermetically Sealed Scroll Type	Hermetically Sealed Scroll Type	Hermetically Sealed Scroll Type	Hermetically Sealed Scroll Type
	Volume	12.9	16.3	21.2	26.5
	Number of Revolutions	3804	4800	6252	4998
	Motor Output x Number of units	4.0 x 1	5.0 x 1	6.5 x 1	8.5 x 1
Starting Method	Soft Start	Soft Start	Soft Start	Soft Start	Soft Start
	Propeller Fan	Propeller Fan	Propeller Fan	Propeller Fan	Propeller Fan
Fan	Motor Output	0.8 x 2	0.8 x 2	0.8 x 2	0.8 x 2
	Airflow Rate	7283 (206)	7989 (226)	7989 (226)	9480 (268)
Connecting Pipes	Drive	Direct Drive	Direct Drive	Direct Drive	Direct Drive
	Liquid Pipe	Φ3/8 (9.5) C1220T (Brazeing Connection)	Φ3/8 (9.5) C1220T (Brazeing Connection)	Φ1/2 (12.7) C1220T (Brazeing Connection)	Φ5/8 (15.9) C1220T (Brazeing Connection)
	Suction Gas Pipe	Φ3/4 (19.1) C1220T (Brazeing Connection)	Φ7/8 (22.2) C1220T (Brazeing Connection)	Φ1-1/8 (28.6) C1220T (Brazeing Connection)	Φ1-1/8 (28.6) C1220T (Brazeing Connection)
Weight	High/Low Pressure Gas Pipe	Φ5/8 (15.9) C1220T (Brazeing Connection)	Φ3/4 (19.1) C1220T (Brazeing Connection)	Φ3/4 (19.1) C1220T (Brazeing Connection)	Φ7/8 (22.2) C1220T (Brazeing Connection)
	Weight	727 (330)	727 (330)	727 (330)	793 (360)
Sound pressure level (Reference data)	58 (63.5 ★3)	61 (64.5 ★3)	61 (65 ★3)	65 (65.5 ★3)	65 (65.5 ★3)
Sound power level (Reference data)	79	80	80.5	87	88
Safety Devices	High Pressure Switch	High Pressure Switch	High Pressure Switch	High Pressure Switch	High Pressure Switch
	Fan Driver Overload Protector	Fan Driver Overload Protector	Fan Driver Overload Protector	Fan Driver Overload Protector	Fan Driver Overload Protector
	Overcurrent Fuse	Overcurrent Fuse	Overcurrent Fuse	Overcurrent Fuse	Overcurrent Fuse
	Inverter Overload Protector	Inverter Overload Protector	Inverter Overload Protector	Inverter Overload Protector	Inverter Overload Protector
Defrost Method	Leak Detecting Device	Leak Detecting Device	Leak Detecting Device	Leak Detecting Device	Leak Detecting Device
	Deicer	Deicer	Deicer	Deicer	Deicer
Capacity Control	%	13 - 100	11 - 100	14 - 100	12 - 100
	Refrigerant Name	R410A	R410A	R410A	R410A
Standard Accessories	Charge Control	25.8 (11.7)	25.8 (11.7)	25.8 (11.7)	25.8 (11.7)
	Electronic Expansion Valve	Electronic Expansion Valve	Electronic Expansion Valve	Electronic Expansion Valve	Electronic Expansion Valve
Standard Accessories	Installation Manual	Installation Manual	Installation Manual	Installation Manual	Installation Manual
	Operation Manual	Operation Manual	Operation Manual	Operation Manual	Operation Manual
Standard Accessories	Connection Pipes, Clamps	Connection Pipes, Clamps	Connection Pipes, Clamps	Connection Pipes, Clamps	Connection Pipes, Clamps
	Connection Pipes, Clamps	Connection Pipes, Clamps	Connection Pipes, Clamps	Connection Pipes, Clamps	Connection Pipes, Clamps

Notes
 ★1 Indoor Temp.: 80°FDB (26.7°CDB) / Outdoor Temp.: 35°FDB (3.3°CDB) / Rated capacity is certified under AHRI standard 1200.
 ★2 Indoor Temp.: 70°FDB (21.1°CDB) / Outdoor Temp.: 47°FDB (8.3°CDB) / Rated capacity is certified under AHRI standard 1200.
 ★3 Sound pressure level may increase during heating operation at ambient temps below 41°F (5°C) value in parenthesis is the max sound pressure at those conditions.

REYQ216 - 336XBTA

Outdoor Unit Model No.	REYQ192XBTA	REYQ216XBTA	REYQ240XBTA	REYQ264XBTA	REYQ288XBTA	REYQ312XBTA	REYQ336XBTA
Unit Combination	REYQ96XBTA REYQ96XBTA	REYQ96XBTA REYQ120XBTA	REYQ120XBTA REYQ120XBTA	REYQ120XBTA REYQ144XBTA	REYQ144XBTA REYQ144XBTA	REYQ168XBTA REYQ168XBTA	REYQ168XBTA REYQ168XBTA
Power Supply	3 phase, 60Hz, 208/230V	3 phase, 60Hz, 208/230V	3 phase, 60Hz, 208/230V	3 phase, 60Hz, 208/230V	3 phase, 60Hz, 208/230V	3 phase, 60Hz, 208/230V	3 phase, 60Hz, 208/230V
*1 Cooling Capacity	Nominal 192,000 (56.3) Rated 184,000 (60.4)	Nominal 216,000 (63.3) Rated 206,000 (60.4)	Nominal 238,000 (69.8) Rated 252,000 (73.9)	Nominal 266,000 (83.8) Rated 274,000 (80.3)	Nominal 286,000 (83.8) Rated 296,000 (86.7)	Nominal 310,000 (90.9) Rated 316,000 (92.6)	Nominal 330,000 (96.7) Rated 316,000 (92.6)
*2 Heating Capacity	Nominal 216,000 (63.3) Rated 184,000 (56.3)	Nominal 243,000 (71.2) Rated 206,000 (60.4)	Nominal 270,000 (79.1) Rated 228,000 (66.8)	Nominal 324,000 (95.0) Rated 264,000 (77.4)	Nominal 351,000 (102.9) Rated 270,000 (79.1)	Nominal 378,000 (110.8) Rated 280,000 (82.1)	Nominal 378,000 (110.8) Rated 280,000 (82.1)
Casing Color	Ivory White (S7/5/1)	Ivory White (S7/5/1)	Ivory White (S7/5/1)	Ivory White (S7/5/1)	Ivory White (S7/5/1)	Ivory White (S7/5/1)	Ivory White (S7/5/1)
Dimensions: (H x W x D)	66-11/16 x 48-7/8 x 30-3/16 + (1694 x 1242 x 767 + 1694 x 1242 x 767)	66-11/16 x 48-7/8 x 30-3/16 + (1694 x 1242 x 767 + 1694 x 1242 x 767)	66-11/16 x 48-7/8 x 30-3/16 + (1694 x 1242 x 767 + 1694 x 1242 x 767)	66-11/16 x 48-7/8 x 30-3/16 + (1694 x 1242 x 767 + 1694 x 1242 x 767)	66-11/16 x 48-7/8 x 30-3/16 + (1694 x 1242 x 767 + 1694 x 1242 x 767)	66-11/16 x 48-7/8 x 30-3/16 + (1694 x 1242 x 767 + 1694 x 1242 x 767)	66-11/16 x 48-7/8 x 30-3/16 + (1694 x 1242 x 767 + 1694 x 1242 x 767)
Heat Exchanger	Cross Fin Coil	Cross Fin Coil	Cross Fin Coil	Cross Fin Coil	Cross Fin Coil	Cross Fin Coil	Cross Fin Coil
Compressor	Hermetically Sealed Scroll Type	Hermetically Sealed Scroll Type	Hermetically Sealed Scroll Type	Hermetically Sealed Scroll Type	Hermetically Sealed Scroll Type	Hermetically Sealed Scroll Type	Hermetically Sealed Scroll Type
Volume	m ³ /h 16.7 + 16.7	18.7 + 18.7	20.9 + 20.9	22.4 + 24.1	24.4 + 24.4	26.2 + 26.2	28.8 + 28.8
Number of Revolutions	r/min 4932 + 4932	5514 + 5514	6162 + 6162	6606 + 4536	4596 + 4596	4932 + 4932	5436 + 5436
Motor Output x Number of units	5.1 x 1 + 5.1 x 1	5.7 x 1 + 5.7 x 1	6.4 x 1 + 6.4 x 1	6.9 x 1 + 6.9 x 1	7.0 x 1 + 7.0 x 1	7.5 x 1 + 7.5 x 1	8.3 x 1 + 8.3 x 1
Starting Method	Soft Start	Soft Start	Soft Start	Soft Start	Soft Start	Soft Start	Soft Start
Type	Propeller Fan	Propeller Fan	Propeller Fan	Propeller Fan	Propeller Fan	Propeller Fan	Propeller Fan
Motor Output	kw (0.8 x 2) x 2	(0.8 x 2) x 2	(0.8 x 2) x 2	(0.8 x 2) x 2	(0.8 x 2) x 2	(0.8 x 2) x 2	(0.8 x 2) x 2
Airflow Rate	cfm (m ³ /min) 7989 + 7989 (226 + 226)	7989 + 7989 (226 + 226)	7989 + 7989 (226 + 226)	7989 + 9480 (226 + 268)	9480 + 9480 (268 + 268)	9480 + 9480 (268 + 268)	9480 + 9480 (268 + 268)
Drive	Direct Drive	Direct Drive	Direct Drive	Direct Drive	Direct Drive	Direct Drive	Direct Drive
Liquid Pipe	Φ5/8 (15.9) C1220T (Braze Connection)	Φ5/8 (15.9) C1220T (Braze Connection)	Φ5/8 (15.9) C1220T (Braze Connection)	Φ3/4 (19.1) C1220T (Braze Connection)	Φ3/4 (19.1) C1220T (Braze Connection)	Φ3/4 (19.1) C1220T (Braze Connection)	Φ3/4 (19.1) C1220T (Braze Connection)
Gas Pipe	Φ1-1/8 (28.6) C1220T (Braze Connection)	Φ1-1/8 (28.6) C1220T (Braze Connection)	Φ1-3/8 (34.9) C1220T (Braze Connection)	Φ1-3/8 (34.9) C1220T (Braze Connection)	Φ1-3/8 (34.9) C1220T (Braze Connection)	Φ1-3/8 (34.9) C1220T (Braze Connection)	Φ1-3/8 (34.9) C1220T (Braze Connection)
High/Low Pressure Gas Pipe	in. (mm) Φ1-1/8 (28.6) C1220T (Braze Connection)	in. (mm) Φ1-1/8 (28.6) C1220T (Braze Connection)	in. (mm) Φ1-1/8 (28.6) C1220T (Braze Connection)	in. (mm) Φ1-1/8 (28.6) C1220T (Braze Connection)	in. (mm) Φ1-1/8 (28.6) C1220T (Braze Connection)	in. (mm) Φ1-1/8 (28.6) C1220T (Braze Connection)	in. (mm) Φ1-1/8 (28.6) C1220T (Braze Connection)
Weight	lbs (kg) 727 + 727 (330 + 330)	727 + 727 (330 + 330)	727 + 727 (330 + 330)	727 + 793 (330 + 360)	793 + 793 (360 + 360)	793 + 793 (360 + 360)	793 + 793 (360 + 360)
Sound pressure level (Reference data)	dB(A) 64 (67.5 ★3)	64 (66 ★3)	64 (68 ★3)	66.5 (68 ★3)	68 (68.5 ★3)	68 (68.5 ★3)	68 (68.5 ★3)
Sound power level (Reference data)	dB 83	83.5	83.5	88	90	90.5	91
Safety Devices	High Pressure Switch, Fan Driver Overload Protector, Overcurrent Fuse, Inverter Overload Protector, Leak Detecting Device	High Pressure Switch, Fan Driver Overload Protector, Overcurrent Fuse, Inverter Overload Protector, Leak Detecting Device	High Pressure Switch, Fan Driver Overload Protector, Overcurrent Fuse, Inverter Overload Protector, Leak Detecting Device	High Pressure Switch, Fan Driver Overload Protector, Overcurrent Fuse, Inverter Overload Protector, Leak Detecting Device	High Pressure Switch, Fan Driver Overload Protector, Overcurrent Fuse, Inverter Overload Protector, Leak Detecting Device	High Pressure Switch, Fan Driver Overload Protector, Overcurrent Fuse, Inverter Overload Protector, Leak Detecting Device	High Pressure Switch, Fan Driver Overload Protector, Overcurrent Fuse, Inverter Overload Protector, Leak Detecting Device
Defrost Method	Deicer	Deicer	Deicer	Deicer	Deicer	Deicer	Deicer
Capacity Control	% 6 - 100	6 - 100	5 - 100	5 - 100	7 - 100	6 - 100	6 - 100
Refrigerant	R410A	R410A	R410A	R410A	R410A	R410A	R410A
Charge	lbs (kg) 25.8 + 25.8 (11.7 + 11.7)	25.8 + 25.8 (11.7 + 11.7)	25.8 + 25.8 (11.7 + 11.7)	25.8 + 25.8 (11.7 + 11.7)	25.8 + 25.8 (11.7 + 11.7)	25.8 + 25.8 (11.7 + 11.7)	25.8 + 25.8 (11.7 + 11.7)
Control	Electronic Expansion Valve	Electronic Expansion Valve	Electronic Expansion Valve	Electronic Expansion Valve	Electronic Expansion Valve	Electronic Expansion Valve	Electronic Expansion Valve
Standard Accessories	Installation Manual, Operation Manual, Connection Pipes, Clamps	Installation Manual, Operation Manual, Connection Pipes, Clamps	Installation Manual, Operation Manual, Connection Pipes, Clamps	Installation Manual, Operation Manual, Connection Pipes, Clamps	Installation Manual, Operation Manual, Connection Pipes, Clamps	Installation Manual, Operation Manual, Connection Pipes, Clamps	Installation Manual, Operation Manual, Connection Pipes, Clamps

Notes
 ★1 Indoor Temp.: 80°FDB (26.7°CDB) / Outdoor Temp.: 95°FDB (35.0°CDB) / Rated capacity is certified under AHRI standard 1200.
 ★2 Indoor Temp.: 70°FDB (21.1°CDB) / Outdoor Temp.: 47°FDB (8.3°CDB) / Rated capacity is certified under AHRI standard 1200.
 ★3 Sound pressure level may increase during heating operation at ambient temps below 41°F (5°C) value in parenthesis is the max sound pressure at those conditions.

REYQ360 - 456XB7JA

Outdoor Unit Model No.	REYQ360XB7JA	REYQ348XB7JA	REYQ408XB7JA	REYQ432XB7JA	REYQ456XB7JA	
Unit Combination	REYQ120XB7JA REYQ120XB7JA REYQ120XB7JA	REYQ120XB7JA REYQ120XB7JA REYQ144XB7JA	REYQ120XB7JA REYQ144XB7JA REYQ144XB7JA	REYQ144XB7JA REYQ144XB7JA REYQ144XB7JA	REYQ144XB7JA REYQ144XB7JA REYQ168XB7JA	
Power Supply	3 phase, 60Hz, 208/230V	3 phase, 60Hz, 208/230V	3 phase, 60Hz, 208/230V	3 phase, 60Hz, 208/230V	3 phase, 60Hz, 208/230V	
*1 Cooling Capacity	Nominal	358,000 (104.9)	Nominal	406,000 (119.0)	Nominal	450,000 (131.9)
	Rated	342,000 (100.2)	Rated	389,000 (113.7)	Rated	430,000 (126.0)
*2 Heating Capacity	Nominal	405,000 (118.7)	Nominal	459,000 (134.5)	Nominal	513,000 (150.3)
	Rated	330,000 (96.7)	Rated	340,000 (99.6)	Rated	366,000 (107.3)
Casing Color	Ivory White (S17.5/1)	Ivory White (S17.5/1)	Ivory White (S17.5/1)	Ivory White (S17.5/1)	Ivory White (S17.5/1)	
Dimensions: (H x W x D)	66-11/16 x 48-7/8 x 30-3/16 + 66-11/16 x 48-7/8 x 30-3/16 + 66-11/16 x 48-7/8 x 30-3/16 (1694 x 1242 x 767 + 1694 x 1242 x 767 + 1694 x 1242 x 767)	66-11/16 x 48-7/8 x 30-3/16 + 66-11/16 x 48-7/8 x 30-3/16 (1694 x 1242 x 767 + 1694 x 1242 x 767 + 1694 x 1242 x 767)	66-11/16 x 48-7/8 x 30-3/16 + 66-11/16 x 48-7/8 x 30-3/16 (1694 x 1242 x 767 + 1694 x 1242 x 767 + 1694 x 1242 x 767)	66-11/16 x 48-7/8 x 30-3/16 + 66-11/16 x 48-7/8 x 30-3/16 (1694 x 1242 x 767 + 1694 x 1242 x 767 + 1694 x 1242 x 767)	66-11/16 x 48-7/8 x 30-3/16 + 66-11/16 x 48-7/8 x 30-3/16 (1694 x 1242 x 767 + 1694 x 1242 x 767 + 1694 x 1242 x 767)	
Heat Exchanger	Cross Fin Coil	Cross Fin Coil	Cross Fin Coil	Cross Fin Coil	Cross Fin Coil	
Type	Hermetically Sealed Scroll Type	Hermetically Sealed Scroll Type	Hermetically Sealed Scroll Type	Hermetically Sealed Scroll Type	Hermetically Sealed Scroll Type	
Volume	m ³ /h	20.3 + 20.3 + 20.3	23.4 + 25.1 + 25.1	26.2 + 26.2 + 26.2	28.0 + 28.0 + 28.0	
Number of Revolutions	r/min	5994 + 5994 + 5994	6426 + 6426 + 4410	6888 + 4728 + 4728	5286 + 5286 + 5286	
Motor Output x Number of units	KW	6.2 x 1 + 6.2 x 1 + 6.2 x 1	6.7 x 1 + 6.7 x 1 + 6.7 x 1	7.2 x 1 + 7.2 x 1 + 7.2 x 1	8.1 x 1 + 8.1 x 1 + 8.1 x 1	
Starting Method		Soft Start	Soft Start	Soft Start	Soft Start	
Type	Propeller Fan	Propeller Fan	Propeller Fan	Propeller Fan	Propeller Fan	
Motor Output	KW	(0.8 x 2) x 3	(0.8 x 2) x 3	(0.8 x 2) x 3	(0.8 x 2) x 3	
Airflow Rate	cfm (m ³ /min)	7989 + 7989 + 7989 (226 + 226 + 226)	7989 + 7989 + 9480 (226 + 268 + 268)	7989 + 9480 + 9480 (268 + 268 + 268)	9480 + 9480 + 9480 (268 + 268 + 268)	
Drive		Direct Drive	Direct Drive	Direct Drive	Direct Drive	
Liquid Pipe	in. (mm)	Φ3/4 (19.1) C1220T (Braze Connection)	Φ3/4 (19.1) C1220T (Braze Connection)	Φ3/4 (19.1) C1220T (Braze Connection)	Φ3/4 (19.1) C1220T (Braze Connection)	
Suction Gas Pipe	in. (mm)	Φ1-5/8 (41.3) C1220T (Braze Connection)	Φ1-5/8 (41.3) C1220T (Braze Connection)	Φ1-5/8 (41.3) C1220T (Braze Connection)	Φ1-5/8 (41.3) C1220T (Braze Connection)	
High/Low Pressure Gas Pipe	in. (mm)	Φ1-3/8 (34.9) C1220T (Braze Connection)	Φ1-3/8 (34.9) C1220T (Braze Connection)	Φ1-3/8 (34.9) C1220T (Braze Connection)	Φ1-3/8 (34.9) C1220T (Braze Connection)	
Weight	lbs (kg)	727 + 727 + 727 (330 + 330 + 330)	727 + 727 + 793 (330 + 360 + 360)	793 + 793 + 793 (360 + 360 + 360)	793 + 793 + 793 (360 + 360 + 360)	
Sound pressure level (Reference data)	dBA	66 (70 ★3)	67.5 (70 ★3)	69 (70 ★3)	70	
Sound power level (Reference data)	dB	85.5	89	90.5	92	
Safety Devices		High Pressure Switch, Fan Driver Overload Protector, Overcurrent Fuse, Inverter Overload Protector, Leak Detecting Device	High Pressure Switch, Fan Driver Overload Protector, Overcurrent Fuse, Inverter Overload Protector, Leak Detecting Device	High Pressure Switch, Fan Driver Overload Protector, Overcurrent Fuse, Inverter Overload Protector, Leak Detecting Device	High Pressure Switch, Fan Driver Overload Protector, Overcurrent Fuse, Inverter Overload Protector, Leak Detecting Device	
Defrost Method		Deicer	Deicer	Deicer	Deicer	
Capacity Control	%	3 - 100	3 - 100	3 - 100	4 - 100	
Refrigerant Charge	lbs (kg)	R410A	R410A	R410A	R410A	
Control		Electronic Expansion Valve	Electronic Expansion Valve	Electronic Expansion Valve	Electronic Expansion Valve	
Standard Accessories		Installation Manual, Operation Manual, Connection Pipes, Clamps	Installation Manual, Operation Manual, Connection Pipes, Clamps	Installation Manual, Operation Manual, Connection Pipes, Clamps	Installation Manual, Operation Manual, Connection Pipes, Clamps	

Notes
 ★1 Indoor Temp.: 80°FDB (26.7°CDB) / Outdoor Temp.: 95°FDB (35.0°CDB) / Rated capacity is certified under AHRI standard 1230.
 ★2 Indoor Temp.: 70°FDB (21.1°CDB) / Outdoor Temp.: 47°FDB (8.3°CDB) / Rated capacity is certified under AHRI standard 1230.
 ★3 Sound pressure level may increase during heating operation at ambient temps below 41°F (5°C) value in parenthesis is the max sound pressure at those conditions.

1.2 REYQ-XBYDA

REYQ72 - 168XBYDA

Outdoor Unit Model No.	REYQ72XBDA	REYQ96BYDA	REYQ120XBDA	REYQ144XBDA	REYQ168BYDA
Power Supply	3 phase, 60Hz, 460V	3 phase, 60Hz, 460V	3 phase, 60Hz, 460V	3 phase, 60Hz, 460V	3 phase, 60Hz, 460V
*1 Cooling Capacity	Nominal	72,000 (21.1)	96,000 (28.1)	119,000 (34.9)	Nominal
	Rated	69,000 (20.2)	92,000 (27.0)	114,000 (33.4)	Rated
*2 Heating Capacity	Nominal	81,000 (23.7)	108,000 (31.7)	135,000 (39.6)	Nominal
	Rated	69,000 (20.2)	92,000 (27.0)	114,000 (33.4)	Rated
Casing Color	Ivory White (5Y7.5/1)	Ivory White (5Y7.5/1)	Ivory White (5Y7.5/1)	Ivory White (5Y7.5/1)	Ivory White (5Y7.5/1)
Dimensions: (H x W x D)	66-11/16 x 48-7/8 x 30-3/16 (1694 x 1242 x 767)	66-11/16 x 48-7/8 x 30-3/16 (1694 x 1242 x 767)	66-11/16 x 48-7/8 x 30-3/16 (1694 x 1242 x 767)	66-11/16 x 48-7/8 x 30-3/16 (1694 x 1242 x 767)	66-11/16 x 48-7/8 x 30-3/16 (1694 x 1242 x 767)
Heat Exchanger	Cross Fin Coil	Cross Fin Coil	Cross Fin Coil	Cross Fin Coil	Cross Fin Coil
Type	Hermetically Sealed Scroll Type	Hermetically Sealed Scroll Type	Hermetically Sealed Scroll Type	Hermetically Sealed Scroll Type	Hermetically Sealed Scroll Type
Volume	12.9	16.3	21.2	26.5	29.6
Number of Revolutions	3804	4800	6252	4998	5586
Motor Output x Number of units	4.0 x 1	5.0 x 1	6.5 x 1	7.6 x 1	8.5 x 1
Starting Method	Soft Start	Soft Start	Soft Start	Soft Start	Soft Start
Type	Propeller Fan	Propeller Fan	Propeller Fan	Propeller Fan	Propeller Fan
Motor Output	0.6 x 2	0.6 x 2	0.6 x 2	0.6 x 2	0.6 x 2
Airflow Rate	7283 (206)	7989 (226)	7989 (226)	9480 (268)	9480 (268)
Drive	Direct Drive	Direct Drive	Direct Drive	Direct Drive	Direct Drive
Liquid Pipe	Φ3/8 (9.5) C1220T (Braze Connection)	Φ3/8 (9.5) C1220T (Braze Connection)	Φ1/2 (12.7) C1220T (Braze Connection)	Φ1/2 (12.7) C1220T (Braze Connection)	Φ5/8 (15.9) C1220T (Braze Connection)
Suction Gas Pipe	Φ3/4 (19.1) C1220T (Braze Connection)	Φ7/8 (22.2) C1220T (Braze Connection)	Φ1-1/8 (28.6) C1220T (Braze Connection)	Φ1-1/8 (28.6) C1220T (Braze Connection)	Φ1-1/8 (28.6) C1220T (Braze Connection)
High/Low Pressure Gas Pipe	Φ5/8 (15.9) C1220T (Braze Connection)	Φ3/4 (19.1) C1220T (Braze Connection)	Φ3/4 (19.1) C1220T (Braze Connection)	Φ7/8 (22.2) C1220T (Braze Connection)	Φ7/8 (22.2) C1220T (Braze Connection)
Weight	727 (330)	727 (330)	727 (330)	793 (360)	793 (360)
Sound pressure level (Reference data)	58 (63.5 ★3)	61 (64.5 ★3)	61 (64.5 ★3)	65 (65.5 ★3)	65 (65.5 ★3)
Sound power level (Reference data)	79	80	80.5	87	88
Safety Devices	High Pressure Switch, Fan Driver Overload Protector, Overcurrent Fuse, Inverter Overload Protector, Leak Detecting Device	High Pressure Switch, Fan Driver Overload Protector, Overcurrent Fuse, Inverter Overload Protector, Leak Detecting Device	High Pressure Switch, Fan Driver Overload Protector, Overcurrent Fuse, Inverter Overload Protector, Leak Detecting Device	High Pressure Switch, Fan Driver Overload Protector, Overcurrent Fuse, Inverter Overload Protector, Leak Detecting Device	High Pressure Switch, Fan Driver Overload Protector, Overcurrent Fuse, Inverter Overload Protector, Leak Detecting Device
Defrost Method	Deicer	Deicer	Deicer	Deicer	Deicer
Capacity Control	15 - 100	13 - 100	11 - 100	14 - 100	12 - 100
Refrigerant	R410A	R410A	R410A	R410A	R410A
Control	25.8 (11.7)	25.8 (11.7)	25.8 (11.7)	25.8 (11.7)	25.8 (11.7)
Standard Accessories	Electronic Expansion Valve Installation Manual, Operation Manual, Connection Pipes, Clamps	Electronic Expansion Valve Installation Manual, Operation Manual, Connection Pipes, Clamps	Electronic Expansion Valve Installation Manual, Operation Manual, Connection Pipes, Clamps	Electronic Expansion Valve Installation Manual, Operation Manual, Connection Pipes, Clamps	Electronic Expansion Valve Installation Manual, Operation Manual, Connection Pipes, Clamps

Notes
 ★1 Indoor Temp.: 80°FDB (26.7°CDB) / Outdoor Temp.: 35°FDB (3.3°CDB) / Rated capacity is certified under AHRI standard 1200.
 ★2 Indoor Temp.: 70°FDB (21.1°CDB) / Outdoor Temp.: 47°FDB (8.3°CDB) / Rated capacity is certified under AHRI standard 1200.
 ★3 Sound pressure level may increase during heating operation at ambient temps below 41°F (5°C) value in parenthesis is the max sound pressure at those conditions.

REYQ192 - 336XBYDA

Outdoor Unit Model No.	REYQ192XBVDA	REYQ216XBVDA	REYQ240XBVDA	REYQ244XBVDA	REYQ248XBVDA	REYQ312XBVDA	REYQ336XBVDA
Unit Combination	REYQ9XBVDA REYQ120XBVDA REYQ144XBVDA	REYQ9XBVDA REYQ120XBVDA REYQ144XBVDA	REYQ120XBVDA REYQ144XBVDA REYQ168XBVDA	REYQ120XBVDA REYQ144XBVDA REYQ168XBVDA	REYQ144XBVDA REYQ168XBVDA REYQ192XBVDA	REYQ168XBVDA REYQ192XBVDA REYQ216XBVDA	REYQ168XBVDA REYQ192XBVDA REYQ216XBVDA
Power Supply	3 phase, 60Hz, 460V	3 phase, 60Hz, 460V	3 phase, 60Hz, 460V	3 phase, 60Hz, 460V	3 phase, 60Hz, 460V	3 phase, 60Hz, 460V	3 phase, 60Hz, 460V
*1 Cooling Capacity	Nominal 192,000 (56.3) Rated 184,000 (53.9)	Nominal 216,000 (63.3) Rated 206,000 (60.4)	Nominal 238,000 (69.8) Rated 228,000 (66.8)	Nominal 254,000 (77.4) Rated 252,000 (73.9)	Nominal 286,000 (83.8) Rated 274,000 (80.3)	Nominal 310,000 (90.9) Rated 295,000 (86.7)	Nominal 330,000 (96.7) Rated 316,000 (92.6)
*2 Heating Capacity	Nominal 194,000 (57.3) Rated 184,000 (53.9)	Nominal 216,000 (63.3) Rated 206,000 (60.4)	Nominal 238,000 (69.8) Rated 228,000 (66.8)	Nominal 252,000 (73.9) Rated 252,000 (73.9)	Nominal 284,000 (85.0) Rated 264,000 (77.4)	Nominal 315,000 (92.9) Rated 291,000 (86.2)	Nominal 338,000 (99.4) Rated 318,000 (93.4)
Casing Color	Ivory White (S7/5/1)	Ivory White (S7/5/1)	Ivory White (S7/5/1)	Ivory White (S7/5/1)	Ivory White (S7/5/1)	Ivory White (S7/5/1)	Ivory White (S7/5/1)
Dimensions: (H x W x D)	66-11/16 x 48-7/8 x 30-3/16 + (1694 x 1242 x 767 + 1694 x 1242 x 767)	66-11/16 x 48-7/8 x 30-3/16 + (1694 x 1242 x 767 + 1694 x 1242 x 767)	66-11/16 x 48-7/8 x 30-3/16 + (1694 x 1242 x 767 + 1694 x 1242 x 767)	66-11/16 x 48-7/8 x 30-3/16 + (1694 x 1242 x 767 + 1694 x 1242 x 767)	66-11/16 x 48-7/8 x 30-3/16 + (1694 x 1242 x 767 + 1694 x 1242 x 767)	66-11/16 x 48-7/8 x 30-3/16 + (1694 x 1242 x 767 + 1694 x 1242 x 767)	66-11/16 x 48-7/8 x 30-3/16 + (1694 x 1242 x 767 + 1694 x 1242 x 767)
Heat Exchanger	Cross Fin Coil	Cross Fin Coil	Cross Fin Coil	Cross Fin Coil	Cross Fin Coil	Cross Fin Coil	Cross Fin Coil
Compressor	Hermetically Sealed Scroll Type	Hermetically Sealed Scroll Type	Hermetically Sealed Scroll Type	Hermetically Sealed Scroll Type	Hermetically Sealed Scroll Type	Hermetically Sealed Scroll Type	Hermetically Sealed Scroll Type
Volume	m ³ /h 16.7 + 16.7	m ³ /h 18.7 + 18.7	m ³ /h 20.9 + 20.9	m ³ /h 22.4 + 24.1	m ³ /h 24.4 + 24.4	m ³ /h 26.2 + 26.2	m ³ /h 28.8 + 28.8
Number of Revolutions	4932 + 4932	5514 + 5514	6162 + 6162	6606 + 4536	4596 + 4596	4932 + 4932	5436 + 5436
Motor Output x Number of units	5.1 x 1 + 5.1 x 1	5.7 x 1 + 5.7 x 1	6.4 x 1 + 6.4 x 1	6.9 x 1 + 6.9 x 1	7.0 x 1 + 7.0 x 1	7.5 x 1 + 7.5 x 1	8.3 x 1 + 8.3 x 1
Starting Method	Soft Start	Soft Start	Soft Start	Soft Start	Soft Start	Soft Start	Soft Start
Type	Propeller Fan	Propeller Fan	Propeller Fan	Propeller Fan	Propeller Fan	Propeller Fan	Propeller Fan
Motor Output	kw (0.6 x 2) x 2	kw (0.6 x 2) x 2	kw (0.6 x 2) x 2	kw (0.6 x 2) x 2	kw (0.6 x 2) x 2	kw (0.6 x 2) x 2	kw (0.6 x 2) x 2
Airflow Rate	cfm (m ³ /min) 7989 + 7989 (226 + 226)	cfm (m ³ /min) 7989 + 7989 (226 + 226)	cfm (m ³ /min) 7989 + 7989 (226 + 226)	cfm (m ³ /min) 7989 + 9480 (226 + 268)	cfm (m ³ /min) 7989 + 9480 (226 + 268)	cfm (m ³ /min) 9480 + 9480 (268 + 268)	cfm (m ³ /min) 9480 + 9480 (268 + 268)
Drive	Direct Drive	Direct Drive	Direct Drive	Direct Drive	Direct Drive	Direct Drive	Direct Drive
Liquid Pipe	Ø5/8 (15.9) C1220T (Braze Connection)	Ø5/8 (15.9) C1220T (Braze Connection)	Ø5/8 (15.9) C1220T (Braze Connection)	Ø3/4 (19.1) C1220T (Braze Connection)	Ø3/4 (19.1) C1220T (Braze Connection)	Ø3/4 (19.1) C1220T (Braze Connection)	Ø3/4 (19.1) C1220T (Braze Connection)
Suction Gas Pipe	Ø1-1/8 (28.6) C1220T (Braze Connection)	Ø1-1/8 (28.6) C1220T (Braze Connection)	Ø1-3/8 (34.9) C1220T (Braze Connection)	Ø1-3/8 (34.9) C1220T (Braze Connection)	Ø1-3/8 (34.9) C1220T (Braze Connection)	Ø1-3/8 (34.9) C1220T (Braze Connection)	Ø1-3/8 (34.9) C1220T (Braze Connection)
High/Low Pressure Gas Pipe	Ø1-1/8 (28.6) C1220T (Braze Connection)	Ø1-1/8 (28.6) C1220T (Braze Connection)	Ø1-1/8 (28.6) C1220T (Braze Connection)	Ø1-1/8 (28.6) C1220T (Braze Connection)	Ø1-1/8 (28.6) C1220T (Braze Connection)	Ø1-1/8 (28.6) C1220T (Braze Connection)	Ø1-1/8 (28.6) C1220T (Braze Connection)
Weight	lbs (kg) 727 + 727 (330 + 330)	lbs (kg) 727 + 727 (330 + 330)	lbs (kg) 727 + 727 (330 + 330)	lbs (kg) 727 + 727 (330 + 360)	lbs (kg) 793 + 793 (360 + 360)	lbs (kg) 793 + 793 (360 + 360)	lbs (kg) 793 + 793 (360 + 360)
Sound pressure level (Reference data)	dB(A) 64 (67.5 ★3)	dB(A) 64 (67.5 ★3)	dB(A) 64 (68 ★3)	dB(A) 66.5 (68 ★3)	dB(A) 68 (68.5 ★3)	dB(A) 68 (68.5 ★3)	dB(A) 68 (68.5 ★3)
Sound power level (Reference data)	dB 83	dB 83.5	dB 83.5	dB 88	dB 90	dB 90.5	dB 91
Safety Devices	High Pressure Switch, Fan Driver Overload Protector, Overcurrent Fuse, Inverter Overload Protector, Leak Detecting Device	High Pressure Switch, Fan Driver Overload Protector, Overcurrent Fuse, Inverter Overload Protector, Leak Detecting Device	High Pressure Switch, Fan Driver Overload Protector, Overcurrent Fuse, Inverter Overload Protector, Leak Detecting Device	High Pressure Switch, Fan Driver Overload Protector, Overcurrent Fuse, Inverter Overload Protector, Leak Detecting Device	High Pressure Switch, Fan Driver Overload Protector, Overcurrent Fuse, Inverter Overload Protector, Leak Detecting Device	High Pressure Switch, Fan Driver Overload Protector, Overcurrent Fuse, Inverter Overload Protector, Leak Detecting Device	High Pressure Switch, Fan Driver Overload Protector, Overcurrent Fuse, Inverter Overload Protector, Leak Detecting Device
Defrost Method	Deicer	Deicer	Deicer	Deicer	Deicer	Deicer	Deicer
Capacity Control	% 6 - 100	% 6 - 100	% 5 - 100	% 5 - 100	% 5 - 100	% 6 - 100	% 6 - 100
Refrigerant	R410A	R410A	R410A	R410A	R410A	R410A	R410A
Charge	lbs (kg) 25.8 + 25.8 (11.7 + 11.7)	lbs (kg) 25.8 + 25.8 (11.7 + 11.7)	lbs (kg) 25.8 + 25.8 (11.7 + 11.7)	lbs (kg) 25.8 + 25.8 (11.7 + 11.7)	lbs (kg) 25.8 + 25.8 (11.7 + 11.7)	lbs (kg) 25.8 + 25.8 (11.7 + 11.7)	lbs (kg) 25.8 + 25.8 (11.7 + 11.7)
Control	Electronic Expansion Valve	Electronic Expansion Valve	Electronic Expansion Valve	Electronic Expansion Valve	Electronic Expansion Valve	Electronic Expansion Valve	Electronic Expansion Valve
Standard Accessories	Installation Manual, Operation Manual	Installation Manual, Operation Manual	Installation Manual, Operation Manual	Installation Manual, Operation Manual	Installation Manual, Operation Manual	Installation Manual, Operation Manual	Installation Manual, Operation Manual
Connection Pipes, Clamps	Connection Pipes, Clamps	Connection Pipes, Clamps	Connection Pipes, Clamps	Connection Pipes, Clamps	Connection Pipes, Clamps	Connection Pipes, Clamps	Connection Pipes, Clamps

Notes
 ★1 Indoor Temp.: 80°FDB (26.7°CDB) / Outdoor Temp.: 35°FDB (3.3°CDB) / Rated capacity is certified under AHRI standard 1230.
 ★2 Indoor Temp.: 70°FDB (21.1°CDB) / Outdoor Temp.: 47°FDB (8.3°CDB) / Rated capacity is certified under AHRI standard 1230.
 ★3 Sound pressure level may increase during heating operation at ambient temps below 41°F (5°C) value in parenthesis is the max sound pressure at those conditions.

REYQ360 - 456XBYDA

Outdoor Unit Model No.	REYQ360XBDA	REYQ384XBDA	REYQ408XBDA	REYQ432XBDA	REYQ456XBDA
Unit Combination	REYQ120XBDA REYQ120XBDA REYQ144XBDA	REYQ120XBDA REYQ120XBDA REYQ144XBDA	REYQ120XBDA REYQ120XBDA REYQ144XBDA	REYQ144XBDA REYQ144XBDA REYQ144XBDA	REYQ144XBDA REYQ144XBDA REYQ168XBDA
Power Supply	3 phase, 60Hz, 460V	3 phase, 60Hz, 460V	3 phase, 60Hz, 460V	3 phase, 60Hz, 460V	3 phase, 60Hz, 460V
1- Cooling Capacity	Btu/h (kW) Nominal 358,000 (104.9) Rated 342,000 (100.2)	Nominal 382,000 (112.0) Rated 364,000 (106.7)	Nominal 406,000 (119.0) Rated 389,000 (113.7)	Nominal 430,000 (126.0) Rated 410,000 (120.2)	Nominal 450,000 (131.9) Rated 430,000 (126.0)
2- Heating Capacity	Btu/h (kW) Nominal 405,000 (118.7) Rated 330,000 (96.7)	Nominal 432,000 (126.6) Rated 340,000 (99.6)	Nominal 459,000 (134.5) Rated 348,000 (102.0)	Nominal 486,000 (142.4) Rated 366,000 (107.3)	Nominal 513,000 (150.3) Rated 400,000 (117.2)
Casing Color	Ivory White (577.5/1)	Ivory White (577.5/1)	Ivory White (577.5/1)	Ivory White (577.5/1)	Ivory White (577.5/1)
Dimensions: (H x W x D) in. (mm)	66-11/16 x 48-7/8 x 30-3/16 + 66-11/16 x 48-7/8 x 30-3/16 + 66-11/16 x 48-7/8 x 30-3/16 (1694 x 1242 x 767 + 1694 x 1242 x 767 + 1694 x 1242 x 767)	66-11/16 x 48-7/8 x 30-3/16 + 66-11/16 x 48-7/8 x 30-3/16 (1694 x 1242 x 767 + 1694 x 1242 x 767 + 1694 x 1242 x 767)	66-11/16 x 48-7/8 x 30-3/16 + 66-11/16 x 48-7/8 x 30-3/16 (1694 x 1242 x 767 + 1694 x 1242 x 767 + 1694 x 1242 x 767)	66-11/16 x 48-7/8 x 30-3/16 + 66-11/16 x 48-7/8 x 30-3/16 (1694 x 1242 x 767 + 1694 x 1242 x 767 + 1694 x 1242 x 767)	66-11/16 x 48-7/8 x 30-3/16 + 66-11/16 x 48-7/8 x 30-3/16 (1694 x 1242 x 767 + 1694 x 1242 x 767 + 1694 x 1242 x 767)
Heat Exchanger	Cross Fin Coil	Cross Fin Coil	Cross Fin Coil	Cross Fin Coil	Cross Fin Coil
Type	Hermetically Sealed Scroll Type	Hermetically Sealed Scroll Type	Hermetically Sealed Scroll Type	Hermetically Sealed Scroll Type	Hermetically Sealed Scroll Type
Volume	m ³ /h 20.3 + 20.3 + 20.3	21.8 + 21.8 + 23.4	23.4 + 25.1 + 25.1	26.2 + 26.2 + 26.2	28.0 + 28.0 + 28.0
Number of Revolutions	r/min 5994 + 5994 + 5994	6426 + 6426 + 4410	6888 + 4728 + 4728	4932 + 4932 + 4932	5286 + 5286 + 5286
Motor Output x Number of units	kW 6.2 x 1 + 6.2 x 1 + 6.2 x 1	6.7 x 1 + 6.7 x 1 + 6.7 x 1	7.2 x 1 + 7.2 x 1 + 7.2 x 1	7.5 x 1 + 7.5 x 1 + 7.5 x 1	8.1 x 1 + 8.1 x 1 + 8.1 x 1
Starting Method	Soft Start	Soft Start	Soft Start	Soft Start	Soft Start
Type	Propeller Fan	Propeller Fan	Propeller Fan	Propeller Fan	Propeller Fan
Motor Output	kW (0.6 x 2) x 3	(0.6 x 2) x 3	(0.6 x 2) x 3	(0.6 x 2) x 3	(0.6 x 2) x 3
Airflow Rate	cfm (m ³ /min) 7989 + 7989 + 7989 (226 + 226 + 226)	7989 + 7989 + 9480 (226 + 226 + 268)	7989 + 9480 + 9480 (226 + 268 + 268)	9480 + 9480 + 9480 (268 + 268 + 268)	9480 + 9480 + 9480 (268 + 268 + 268)
Drive	Direct Drive	Direct Drive	Direct Drive	Direct Drive	Direct Drive
Liquid Pipe	in. (mm) Φ3/4 (19.1) C1220T (Braze Connection)	Φ3/4 (19.1) C1220T (Braze Connection)	Φ3/4 (19.1) C1220T (Braze Connection)	Φ3/4 (19.1) C1220T (Braze Connection)	Φ3/4 (19.1) C1220T (Braze Connection)
Suction Gas Pipe	in. (mm) Φ1-5/8 (41.3) C1220T (Braze Connection)	Φ1-5/8 (41.3) C1220T (Braze Connection)	Φ1-5/8 (41.3) C1220T (Braze Connection)	Φ1-5/8 (41.3) C1220T (Braze Connection)	Φ1-5/8 (41.3) C1220T (Braze Connection)
High/Low Pressure Gas Pipe	in. (mm) Φ1-3/8 (34.9) C1220T (Braze Connection)	Φ1-3/8 (34.9) C1220T (Braze Connection)	Φ1-3/8 (34.9) C1220T (Braze Connection)	Φ1-3/8 (34.9) C1220T (Braze Connection)	Φ1-3/8 (34.9) C1220T (Braze Connection)
Weight	lbs (kg) 727 + 727 + 727 (330 + 330 + 330)	727 + 727 + 793 (330 + 330 + 360)	727 + 793 + 793 (330 + 360 + 360)	793 + 793 + 793 (360 + 360 + 360)	793 + 793 + 793 (360 + 360 + 360)
Sound pressure level (Reference data)	dB(A) 66 (70 ★3)	67.5 (70 ★3)	69 (70 ★3)	70	70
Sound power level (Reference data)	dB 85.5	89	90.5	92	92.5
Safety Devices	High Pressure Switch, Fan Driver Overload Protector, Overcurrent Fuse, Inverter Overload Protector, Leak Detecting Device	High Pressure Switch, Fan Driver Overload Protector, Overcurrent Fuse, Inverter Overload Protector, Leak Detecting Device	High Pressure Switch, Fan Driver Overload Protector, Overcurrent Fuse, Inverter Overload Protector, Leak Detecting Device	High Pressure Switch, Fan Driver Overload Protector, Overcurrent Fuse, Inverter Overload Protector, Leak Detecting Device	High Pressure Switch, Fan Driver Overload Protector, Overcurrent Fuse, Inverter Overload Protector, Leak Detecting Device
Defrost Method	Deicer	Deicer	Deicer	Deicer	Deicer
Capacity Control	% 3 - 100	3 - 100	3 - 100	3 - 100	3 - 100
Refrigerant Charge	lbs (kg) R410A 25.8 + 25.8 + 25.8 (11.7 + 11.7 + 11.7)	R410A 25.8 + 25.8 + 25.8 (11.7 + 11.7 + 11.7)	R410A 25.8 + 25.8 + 25.8 (11.7 + 11.7 + 11.7)	R410A 25.8 + 25.8 + 25.8 (11.7 + 11.7 + 11.7)	R410A 25.8 + 25.8 + 25.8 (11.7 + 11.7 + 11.7)
Control	Electronic Expansion Valve	Electronic Expansion Valve	Electronic Expansion Valve	Electronic Expansion Valve	Electronic Expansion Valve
Standard Accessories	Installation Manual, Operation Manual, Connection Pipes, Clamps	Installation Manual, Operation Manual, Connection Pipes, Clamps	Installation Manual, Operation Manual, Connection Pipes, Clamps	Installation Manual, Operation Manual, Connection Pipes, Clamps	Installation Manual, Operation Manual, Connection Pipes, Clamps

Notes
 ★1 Indoor Temp.: 80°FDB (26.7°CDB) / 67°FWB (19.4°CWB) / Outdoor Temp.: 95°FDB (35.0°CDB) / Rated capacity is certified under AHRI standard 1230.
 ★2 Indoor Temp.: 70°FDB (21.1°CDB) / Outdoor Temp.: 47°FDB (8.3°CDB) / Rated capacity is certified under AHRI standard 1230.
 ★3 Sound pressure level may increase during heating operation at ambient temps below 41°F (5°C) value in parenthesis is the max sound pressure at those conditions.

1.3 REYQ-XBYCA

REYQ72 - 168XBYCA

Outdoor Unit Model No.	REYQ72XBYCA	REYQ96XBYCA	REYQ120XBYCA	REYQ144XBYCA	REYQ168XBYCA
Power Supply	3 phase, 60Hz, 575V	3 phase, 60Hz, 575V	3 phase, 60Hz, 575V	3 phase, 60Hz, 575V	3 phase, 60Hz, 575V
*1 Cooling Capacity	Nominal	72,000 (21.1)	96,000 (28.1)	119,000 (34.9)	Nominal
	Rated	69,000 (20.2)	92,000 (27.0)	114,000 (33.4)	Rated
*2 Heating Capacity	Nominal	81,000 (23.7)	108,000 (31.7)	135,000 (39.6)	Nominal
	Rated	69,000 (20.2)	92,000 (27.0)	114,000 (33.4)	Rated
Casing Color	Ivory White (5Y7.5/1)	Ivory White (5Y7.5/1)	Ivory White (5Y7.5/1)	Ivory White (5Y7.5/1)	Ivory White (5Y7.5/1)
Dimensions: (H x W x D)	66-11/16 x 48-7/8 x 30-3/16 (1694 x 1242 x 767)	66-11/16 x 48-7/8 x 30-3/16 (1694 x 1242 x 767)	66-11/16 x 48-7/8 x 30-3/16 (1694 x 1242 x 767)	66-11/16 x 48-7/8 x 30-3/16 (1694 x 1242 x 767)	66-11/16 x 48-7/8 x 30-3/16 (1694 x 1242 x 767)
Heat Exchanger	Cross Fin Coil	Cross Fin Coil	Cross Fin Coil	Cross Fin Coil	Cross Fin Coil
Type	Hermetically Sealed Scroll Type	Hermetically Sealed Scroll Type	Hermetically Sealed Scroll Type	Hermetically Sealed Scroll Type	Hermetically Sealed Scroll Type
Volume	12.9	16.3	21.2	26.5	29.6
Number of Revolutions	3804	4800	6252	4998	5586
Motor Output x Number of units	4.0 x 1	5.0 x 1	6.5 x 1	7.6 x 1	8.5 x 1
Starting Method	Soft Start	Soft Start	Soft Start	Soft Start	Soft Start
Type	Propeller Fan	Propeller Fan	Propeller Fan	Propeller Fan	Propeller Fan
Motor Output	0.7 x 2	0.7 x 2	0.7 x 2	0.7 x 2	0.7 x 2
Airflow Rate	7283 (206)	7989 (226)	7989 (226)	9480 (268)	9480 (268)
Drive	Direct Drive	Direct Drive	Direct Drive	Direct Drive	Direct Drive
Liquid Pipe	Φ3/8 (9.5) C1220T (Braze Connection)	Φ3/8 (9.5) C1220T (Braze Connection)	Φ1/2 (12.7) C1220T (Braze Connection)	Φ1/2 (12.7) C1220T (Braze Connection)	Φ5/8 (15.9) C1220T (Braze Connection)
Suction Gas Pipe	Φ3/4 (19.1) C1220T (Braze Connection)	Φ7/8 (22.2) C1220T (Braze Connection)	Φ1-1/8 (28.6) C1220T (Braze Connection)	Φ1-1/8 (28.6) C1220T (Braze Connection)	Φ1-1/8 (28.6) C1220T (Braze Connection)
High/Low Pressure Gas Pipe	Φ5/8 (15.9) C1220T (Braze Connection)	Φ3/4 (19.1) C1220T (Braze Connection)	Φ3/4 (19.1) C1220T (Braze Connection)	Φ7/8 (22.2) C1220T (Braze Connection)	Φ7/8 (22.2) C1220T (Braze Connection)
Weight	727 (330)	727 (330)	727 (330)	793 (360)	793 (360)
Sound pressure level (Reference data)	58 (63.5 ★3)	61 (64.5 ★3)	61 (64.5 ★3)	65 (65.5 ★3)	65 (65.5 ★3)
Sound power level (Reference data)	79	80	80.5	87	88
Safety Devices	High Pressure Switch, Fan Driver Overload Protector, Overcurrent Fuse, Inverter Overload Protector, Leak Detecting Device	High Pressure Switch, Fan Driver Overload Protector, Overcurrent Fuse, Inverter Overload Protector, Leak Detecting Device	High Pressure Switch, Fan Driver Overload Protector, Overcurrent Fuse, Inverter Overload Protector, Leak Detecting Device	High Pressure Switch, Fan Driver Overload Protector, Overcurrent Fuse, Inverter Overload Protector, Leak Detecting Device	High Pressure Switch, Fan Driver Overload Protector, Overcurrent Fuse, Inverter Overload Protector, Leak Detecting Device
Defrost Method	Deicer	Deicer	Deicer	Deicer	Deicer
Capacity Control	15 - 100	13 - 100	11 - 100	14 - 100	12 - 100
Refrigerant	R410A	R410A	R410A	R410A	R410A
Control	25.8 (11.7)	25.8 (11.7)	25.8 (11.7)	25.8 (11.7)	25.8 (11.7)
Standard Accessories	Electronic Expansion Valve Installation Manual, Operation Manual, Connection Pipes, Clamps	Electronic Expansion Valve Installation Manual, Operation Manual, Connection Pipes, Clamps	Electronic Expansion Valve Installation Manual, Operation Manual, Connection Pipes, Clamps	Electronic Expansion Valve Installation Manual, Operation Manual, Connection Pipes, Clamps	Electronic Expansion Valve Installation Manual, Operation Manual, Connection Pipes, Clamps

Notes
 ★1 Indoor Temp.: 80°FDB (26.7°CDB) / Outdoor Temp.: 35°FDB (3.3°CDB) / Rated capacity is certified under AHRI standard 1200.
 ★2 Indoor Temp.: 70°FDB (21.1°CDB) / Outdoor Temp.: 47°FDB (8.3°CDB) / Rated capacity is certified under AHRI standard 1200.
 ★3 Sound pressure level may increase during heating operation at ambient temps below 41°F (5°C) value in parenthesis is the max sound pressure at those conditions.

REYQ192 - 336XBYCA

Outdoor Unit Model No.	REYQ192XBYCA	REYQ216XBYCA	REYQ240XBYCA	REYQ244XBYCA	REYQ248XBYCA	REYQ312XBYCA	REYQ336XBYCA
Unit Combination	REYQ96XBVCA REYQ96XBVCA	REYQ120XBVCA REYQ120XBVCA	REYQ120XBVCA REYQ144XBVCA	REYQ144XBVCA REYQ144XBVCA	REYQ168XBVCA REYQ168XBVCA	REYQ168XBVCA REYQ168XBVCA	REYQ168XBVCA REYQ168XBVCA
Power Supply	3 phase, 60Hz, 275V	3 phase, 60Hz, 275V	3 phase, 60Hz, 275V	3 phase, 60Hz, 275V	3 phase, 60Hz, 275V	3 phase, 60Hz, 275V	3 phase, 60Hz, 275V
*1 Cooling Capacity	Nominal 192,000 (56.3) Rated 184,000 (53.9)	Nominal 216,000 (63.3) Rated 206,000 (60.4)	Nominal 238,000 (69.8) Rated 228,000 (66.8)	Nominal 264,000 (77.4) Rated 252,000 (73.9)	Nominal 286,000 (83.8) Rated 274,000 (80.3)	Nominal 310,000 (90.9) Rated 295,000 (86.7)	Nominal 330,000 (96.7) Rated 316,000 (92.6)
*2 Heating Capacity	Nominal 194,000 (57.1) Rated 184,000 (53.9)	Nominal 216,000 (63.3) Rated 206,000 (60.4)	Nominal 238,000 (69.8) Rated 228,000 (66.8)	Nominal 264,000 (77.4) Rated 252,000 (73.9)	Nominal 286,000 (83.8) Rated 274,000 (80.3)	Nominal 310,000 (90.9) Rated 295,000 (86.7)	Nominal 330,000 (96.7) Rated 316,000 (92.6)
Casing Color	Ivory White (S7/5/1)	Ivory White (S7/5/1)	Ivory White (S7/5/1)	Ivory White (S7/5/1)	Ivory White (S7/5/1)	Ivory White (S7/5/1)	Ivory White (S7/5/1)
Dimensions: (H x W x D)	66-11/16 x 48-7/8 x 30-3/16 + (1694 x 1242 x 767 + 1694 x 1242 x 767)	66-11/16 x 48-7/8 x 30-3/16 + (1694 x 1242 x 767 + 1694 x 1242 x 767)	66-11/16 x 48-7/8 x 30-3/16 + (1694 x 1242 x 767 + 1694 x 1242 x 767)	66-11/16 x 48-7/8 x 30-3/16 + (1694 x 1242 x 767 + 1694 x 1242 x 767)	66-11/16 x 48-7/8 x 30-3/16 + (1694 x 1242 x 767 + 1694 x 1242 x 767)	66-11/16 x 48-7/8 x 30-3/16 + (1694 x 1242 x 767 + 1694 x 1242 x 767)	66-11/16 x 48-7/8 x 30-3/16 + (1694 x 1242 x 767 + 1694 x 1242 x 767)
Heat Exchanger	Cross Fin Coil	Cross Fin Coil	Cross Fin Coil	Cross Fin Coil	Cross Fin Coil	Cross Fin Coil	Cross Fin Coil
Compressor	Hermetically Sealed Scroll Type	Hermetically Sealed Scroll Type	Hermetically Sealed Scroll Type	Hermetically Sealed Scroll Type	Hermetically Sealed Scroll Type	Hermetically Sealed Scroll Type	Hermetically Sealed Scroll Type
Volume	m ³ /h 16.7 + 16.7	m ³ /h 18.7 + 18.7	m ³ /h 20.9 + 20.9	m ³ /h 22.4 + 24.1	m ³ /h 24.4 + 24.4	m ³ /h 26.2 + 26.2	m ³ /h 28.8 + 28.8
Number of Revolutions	4932 + 4932	5514 + 5514	6162 + 6162	6606 + 4536	4596 + 4596	4932 + 4932	5436 + 5436
Motor Output x Number of units	5.1 x 1 + 5.1 x 1	5.7 x 1 + 5.7 x 1	6.4 x 1 + 6.4 x 1	6.9 x 1 + 6.9 x 1	7.0 x 1 + 7.0 x 1	7.5 x 1 + 7.5 x 1	8.3 x 1 + 8.3 x 1
Starting Method	Soft Start	Soft Start	Soft Start	Soft Start	Soft Start	Soft Start	Soft Start
Type	Propeller Fan	Propeller Fan	Propeller Fan	Propeller Fan	Propeller Fan	Propeller Fan	Propeller Fan
Motor Output	kw (0.7 x 2) x 2	kw (0.7 x 2) x 2	kw (0.7 x 2) x 2	kw (0.7 x 2) x 2	kw (0.7 x 2) x 2	kw (0.7 x 2) x 2	kw (0.7 x 2) x 2
Airflow Rate	cfm (m ³ /min) 7989 + 7989 (226 + 226)	cfm (m ³ /min) 7989 + 7989 (226 + 226)	cfm (m ³ /min) 7989 + 7989 (226 + 226)	cfm (m ³ /min) 7989 + 7989 (226 + 226)	cfm (m ³ /min) 7989 + 7989 (226 + 226)	cfm (m ³ /min) 7989 + 7989 (226 + 226)	cfm (m ³ /min) 7989 + 7989 (226 + 226)
Drive	Direct Drive	Direct Drive	Direct Drive	Direct Drive	Direct Drive	Direct Drive	Direct Drive
Liquid Pipe	Φ5/8 (15.9) C1220T (Braze Connection)	Φ5/8 (15.9) C1220T (Braze Connection)	Φ5/8 (15.9) C1220T (Braze Connection)	Φ3/4 (19.1) C1220T (Braze Connection)	Φ3/4 (19.1) C1220T (Braze Connection)	Φ3/4 (19.1) C1220T (Braze Connection)	Φ3/4 (19.1) C1220T (Braze Connection)
Suction Gas Pipe	Φ1-1/8 (26.6) C1220T (Braze Connection)	Φ1-1/8 (26.6) C1220T (Braze Connection)	Φ1-3/8 (34.9) C1220T (Braze Connection)	Φ1-3/8 (34.9) C1220T (Braze Connection)	Φ1-3/8 (34.9) C1220T (Braze Connection)	Φ1-3/8 (34.9) C1220T (Braze Connection)	Φ1-3/8 (34.9) C1220T (Braze Connection)
High/Low Pressure Gas Pipe	Φ1-1/8 (26.6) C1220T (Braze Connection)	Φ1-1/8 (26.6) C1220T (Braze Connection)	Φ1-1/8 (26.6) C1220T (Braze Connection)	Φ1-1/8 (26.6) C1220T (Braze Connection)	Φ1-1/8 (26.6) C1220T (Braze Connection)	Φ1-1/8 (26.6) C1220T (Braze Connection)	Φ1-1/8 (26.6) C1220T (Braze Connection)
Weight	lbs (kg) 727 + 727 (330 + 330)	lbs (kg) 727 + 727 (330 + 330)	lbs (kg) 727 + 727 (330 + 330)	lbs (kg) 727 + 727 (330 + 360)	lbs (kg) 793 + 793 (360 + 360)	lbs (kg) 793 + 793 (360 + 360)	lbs (kg) 793 + 793 (360 + 360)
Sound pressure level (Reference data)	dB(A) 64 (67.5 ★3)	dB(A) 64 (67.5 ★3)	dB(A) 64 (68 ★3)	dB(A) 66.5 (68 ★3)	dB(A) 68 (68.5 ★3)	dB(A) 68 (68.5 ★3)	dB(A) 68 (68.5 ★3)
Sound power level (Reference data)	dB 83	dB 83.5	dB 83.5	dB 88	dB 90	dB 90.5	dB 91
Safety Devices	High Pressure Switch, Fan Driver Overload Protector, Overcurrent Fuse, Inverter Overload Protector, Leak Detecting Device	High Pressure Switch, Fan Driver Overload Protector, Overcurrent Fuse, Inverter Overload Protector, Leak Detecting Device	High Pressure Switch, Fan Driver Overload Protector, Overcurrent Fuse, Inverter Overload Protector, Leak Detecting Device	High Pressure Switch, Fan Driver Overload Protector, Overcurrent Fuse, Inverter Overload Protector, Leak Detecting Device	High Pressure Switch, Fan Driver Overload Protector, Overcurrent Fuse, Inverter Overload Protector, Leak Detecting Device	High Pressure Switch, Fan Driver Overload Protector, Overcurrent Fuse, Inverter Overload Protector, Leak Detecting Device	High Pressure Switch, Fan Driver Overload Protector, Overcurrent Fuse, Inverter Overload Protector, Leak Detecting Device
Defrost Method	Deicer	Deicer	Deicer	Deicer	Deicer	Deicer	Deicer
Capacity Control	% 6 - 100	% 6 - 100	% 5 - 100	% 5 - 100	% 5 - 100	% 6 - 100	% 6 - 100
Refrigerant	R410A	R410A	R410A	R410A	R410A	R410A	R410A
Charge	lbs (kg) 25.8 + 25.8 (11.7 + 11.7)	lbs (kg) 25.8 + 25.8 (11.7 + 11.7)	lbs (kg) 25.8 + 25.8 (11.7 + 11.7)	lbs (kg) 25.8 + 25.8 (11.7 + 11.7)	lbs (kg) 25.8 + 25.8 (11.7 + 11.7)	lbs (kg) 25.8 + 25.8 (11.7 + 11.7)	lbs (kg) 25.8 + 25.8 (11.7 + 11.7)
Control	Electronic Expansion Valve	Electronic Expansion Valve	Electronic Expansion Valve	Electronic Expansion Valve	Electronic Expansion Valve	Electronic Expansion Valve	Electronic Expansion Valve
Standard Accessories	Installation Manual, Operation Manual, Connection Pipes, Clamps	Installation Manual, Operation Manual, Connection Pipes, Clamps	Installation Manual, Operation Manual, Connection Pipes, Clamps	Installation Manual, Operation Manual, Connection Pipes, Clamps	Installation Manual, Operation Manual, Connection Pipes, Clamps	Installation Manual, Operation Manual, Connection Pipes, Clamps	Installation Manual, Operation Manual, Connection Pipes, Clamps

Notes
 ★1 Indoor Temp.: 80°FDB (26.7°CDB) / Outdoor Temp.: 35°FDB (3.3°CDB) / Rated capacity is certified under AHRI standard 1230.
 ★2 Indoor Temp.: 70°FDB (21.1°CDB) / Outdoor Temp.: 47°FDB (8.3°CDB) / Rated capacity is certified under AHRI standard 1230.
 ★3 Sound pressure level may increase during heating operation at ambient temps below 41°F (5°C) value in parenthesis is the max sound pressure at those conditions.

REYQ360 - 432XBYCA

Outdoor Unit Model No.	REYQ360XBYCA	REYQ384XBYCA	REYQ408XBYCA	REYQ432XBYCA
Unit Combination	REYQ120XBYCA REYQ120XBYCA REYQ144XBYCA	REYQ120XBYCA REYQ120XBYCA REYQ144XBYCA	REYQ120XBYCA REYQ120XBYCA REYQ144XBYCA	REYQ120XBYCA REYQ144XBYCA REYQ144XBYCA
Power Supply	3 phase, 60Hz, 575V	3 phase, 60Hz, 575V	3 phase, 60Hz, 575V	3 phase, 60Hz, 575V
*1 Cooling Capacity	Nominal 358,000 (104.9) Rated 342,000 (100.2)	Nominal 382,000 (112.0) Rated 364,000 (106.7)	Nominal 406,000 (119.0) Rated 388,000 (113.7)	Nominal 426,000 (124.8) Rated 410,000 (120.2)
*2 Heating Capacity	Nominal 405,000 (118.7) Rated 330,000 (96.7)	Nominal 432,000 (126.6) Rated 340,000 (99.6)	Nominal 455,000 (134.5) Rated 348,000 (102.0)	Nominal 486,000 (142.4) Rated 366,000 (107.3)
Casing Color	Ivory White (S17.5/1)	Ivory White (S17.5/1)	Ivory White (S17.5/1)	Ivory White (S17.5/1)
Dimensions: (H x W x D)	66-11/16 x 48-7/8 x 30-3/16 + 66-11/16 x 48-7/8 x 30-3/16 + 66-11/16 x 48-7/8 x 30-3/16 (1694 x 1242 x 767 + 1694 x 1242 x 767 + 1694 x 1242 x 767)	66-11/16 x 48-7/8 x 30-3/16 + 66-11/16 x 48-7/8 x 30-3/16 + 66-11/16 x 48-7/8 x 30-3/16 (1694 x 1242 x 767 + 1694 x 1242 x 767 + 1694 x 1242 x 767)	66-11/16 x 48-7/8 x 30-3/16 + 66-11/16 x 48-7/8 x 30-3/16 + 66-11/16 x 48-7/8 x 30-3/16 (1694 x 1242 x 767 + 1694 x 1242 x 767 + 1694 x 1242 x 767)	66-11/16 x 48-7/8 x 30-3/16 + 66-11/16 x 48-7/8 x 30-3/16 + 66-11/16 x 48-7/8 x 30-3/16 (1694 x 1242 x 767 + 1694 x 1242 x 767 + 1694 x 1242 x 767)
Heat Exchanger	Cross Fin Coil	Cross Fin Coil	Cross Fin Coil	Cross Fin Coil
Compressor	Hermetically Sealed Scroll Type	Hermetically Sealed Scroll Type	Hermetically Sealed Scroll Type	Hermetically Sealed Scroll Type
Volume	20.3 + 20.3 + 20.3	21.8 + 21.8 + 23.4	23.4 + 25.1 + 25.1	26.2 + 26.2 + 26.2
Number of Revolutions	5994 + 5994 + 5994	6426 + 6426 + 4410	6888 + 4728 + 4728	4932 + 4932 + 4932
Motor Output x Number of Units	6.2 x 1 + 6.2 x 1 + 6.2 x 1	6.7 x 1 + 6.7 x 1 + 6.7 x 1	7.2 x 1 + 7.2 x 1 + 7.2 x 1	7.5 x 1 + 7.5 x 1 + 7.5 x 1
Starting Method	Soft Start	Soft Start	Soft Start	Soft Start
Type	Propeller Fan	Propeller Fan	Propeller Fan	Propeller Fan
Motor Output	(0.7 x 2) x 3	(0.7 x 2) x 3	(0.7 x 2) x 3	(0.7 x 2) x 3
Airflow Rate	7989 + 7989 + 7989 (226 + 226 + 226)	7989 + 7989 + 9480 (226 + 226 + 268)	7989 + 9480 + 9480 (226 + 268 + 268)	9480 + 9480 + 9480 (268 + 268 + 268)
Drive	Direct Drive	Direct Drive	Direct Drive	Direct Drive
Liquid Pipe	Φ3/4 (19.1) C1220T (Brazing Connection)	Φ3/4 (19.1) C1220T (Brazing Connection)	Φ3/4 (19.1) C1220T (Brazing Connection)	Φ3/4 (19.1) C1220T (Brazing Connection)
Suction Gas Pipe	Φ1-5/8 (41.3) C1220T (Brazing Connection)	Φ1-5/8 (41.3) C1220T (Brazing Connection)	Φ1-5/8 (41.3) C1220T (Brazing Connection)	Φ1-5/8 (41.3) C1220T (Brazing Connection)
High/Low Pressure Gas Pipe	Φ1-3/8 (34.9) C1220T (Brazing Connection)	Φ1-3/8 (34.9) C1220T (Brazing Connection)	Φ1-3/8 (34.9) C1220T (Brazing Connection)	Φ1-3/8 (34.9) C1220T (Brazing Connection)
Weight	lbs (kg) 727 + 727 + 727 (330 + 330 + 330)	727 + 727 + 793 (330 + 330 + 360)	727 + 793 + 793 (330 + 360 + 360)	793 + 793 + 793 (360 + 360 + 360)
Sound pressure level (Reference data)	dB(A) 66 (70 ★3)	67.5 (70 ★3)	67.5 (70 ★3)	70
Sound power level (Reference data)	dB 85.5	89	90.5	92
Safety Devices	High Pressure Switch, Fan Driver Overload Protector, Overcurrent Fuse, Inverter Overload Protector, Leak Detecting Device	High Pressure Switch, Fan Driver Overload Protector, Overcurrent Fuse, Inverter Overload Protector, Leak Detecting Device	High Pressure Switch, Fan Driver Overload Protector, Overcurrent Fuse, Inverter Overload Protector, Leak Detecting Device	High Pressure Switch, Fan Driver Overload Protector, Overcurrent Fuse, Inverter Overload Protector, Leak Detecting Device
Defrost Method	Deicer	Deicer	Deicer	Deicer
Capacity Control	4 - 100	3 - 100	3 - 100	5 - 100
Refrigerant Name	R410A	R410A	R410A	R410A
Charge	25.8 + 25.8 + 25.8 (11.7 + 11.7 + 11.7)	25.8 + 25.8 + 25.8 (11.7 + 11.7 + 11.7)	25.8 + 25.8 + 25.8 (11.7 + 11.7 + 11.7)	25.8 + 25.8 + 25.8 (11.7 + 11.7 + 11.7)
Control	Electronic Expansion Valve	Electronic Expansion Valve	Electronic Expansion Valve	Electronic Expansion Valve
Standard Accessories	Installation Manual, Operation Manual, Connection Pipes, Clamps	Installation Manual, Operation Manual, Connection Pipes, Clamps	Installation Manual, Operation Manual, Connection Pipes, Clamps	Installation Manual, Operation Manual, Connection Pipes, Clamps

Notes
 ★1 Indoor Temp.: 80°FDB (26.7°CDB) / Outdoor Temp.: 35°FDB (3.5°CDB) / Rated capacity is certified under AHRI standard 1230.
 ★2 Indoor Temp.: 70°FDB (21.1°CDB) / Outdoor Temp.: 47°FDB (8.3°CDB) / Rated capacity is certified under AHRI standard 1230.
 ★3 Sound pressure level may increase during heating operation at ambient temps below 41°F (5°C) value in parenthesis is the max sound pressure at those conditions.

2. Dimensions

REYQ72 - 168XBTJA / XBYDA / XBYCA

Unit : in. (mm)

- Notes)
 1. For piping connection method (front and bottom sides), see the installation manual.
 2. Suction gas pipe

φ1 Brazing connection	REYQ72.96, 120XBTJA-B, XBYDA-B, XBYCA RELQ72BTJA-B, TBIDA-B, TBICA
φ1-1/8 Brazing connection	REYQ144, 168XBTJA-B, XBYDA-B, XBYCA RELQ96, 120TBTJA-B, TBIDA-B, TBICA

Liquid pipe
 φ1/2 Brazing connection
 High / low pressure gas pipe
 φ3/4 Brazing connection

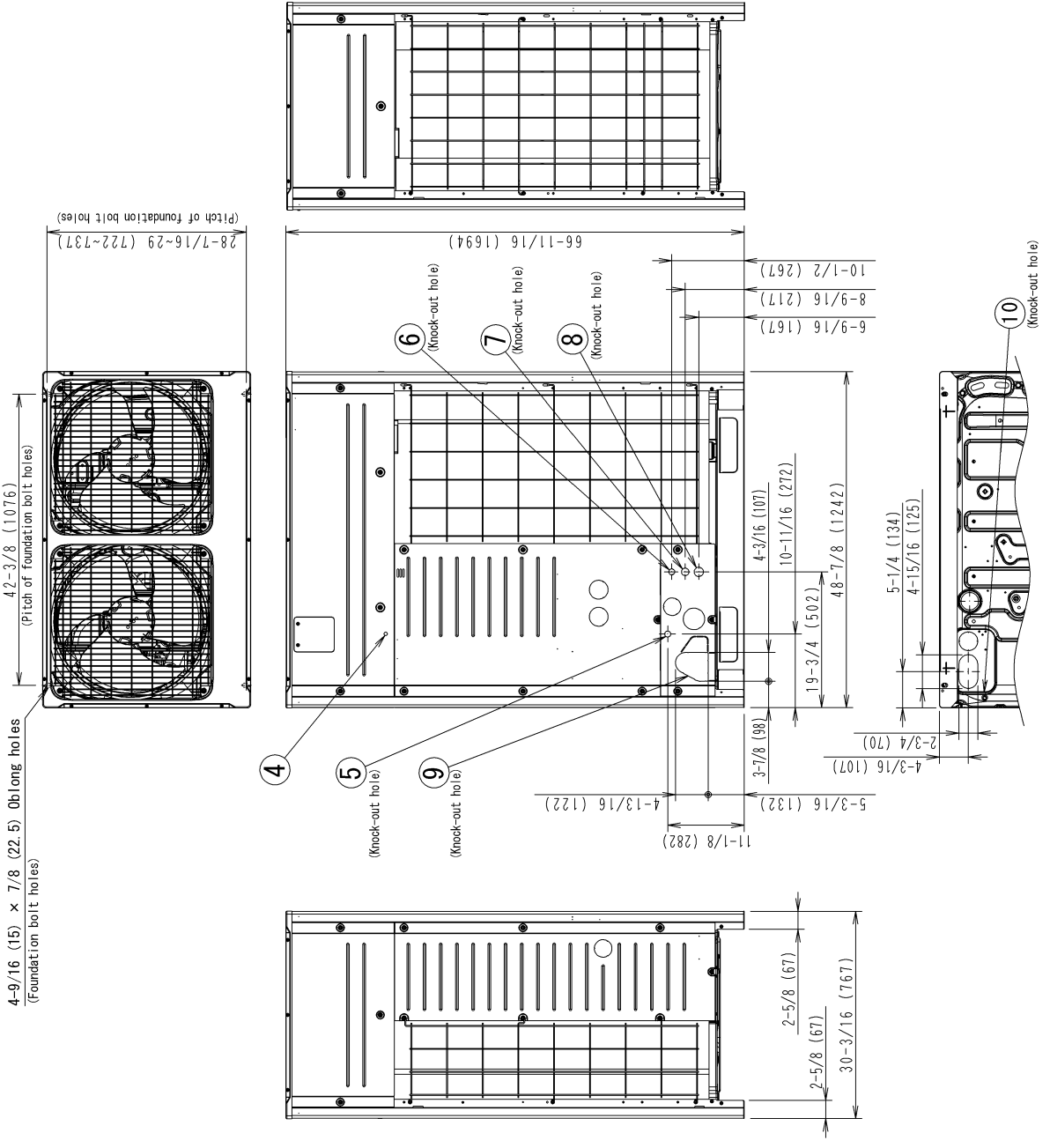

MODEL	A	B
REYQ72.96, 120XBTJA-B, XBYDA-B, XBYCA RELQ72BTJA-B, TBIDA-B, TBICA	4-3/16 (107)	7-1/2 (190)
REYQ144, 168XBTJA-B, XBYDA-B, XBYCA RELQ96, 120TBTJA-B, TBIDA-B, TBICA	4 (102)	7-13/16 (198)

10	Pipe routing hole (bottom)	See note 1.
9	Pipe routing hole (front)	See note 1.
8	Power cord routing hole	φ 1-3/8 (35)
7	Power cord routing hole	φ 1-1/8 (28.6)
6	Power cord routing hole	φ 7/8 (22.2)
5	Transmission wire routing hole	φ 7/8 (22.2)
4	Grounding terminal	Inside of control box (M8)
3	High / low pressure gas pipe connection port	See note 2.
2	Suction gas pipe connection port	See note 2.
1	Liquid pipe connection port	See note 2.
No.	Parts name	Remarks

REYQ192 - 336XB TJA / XBYDA / XBYCA

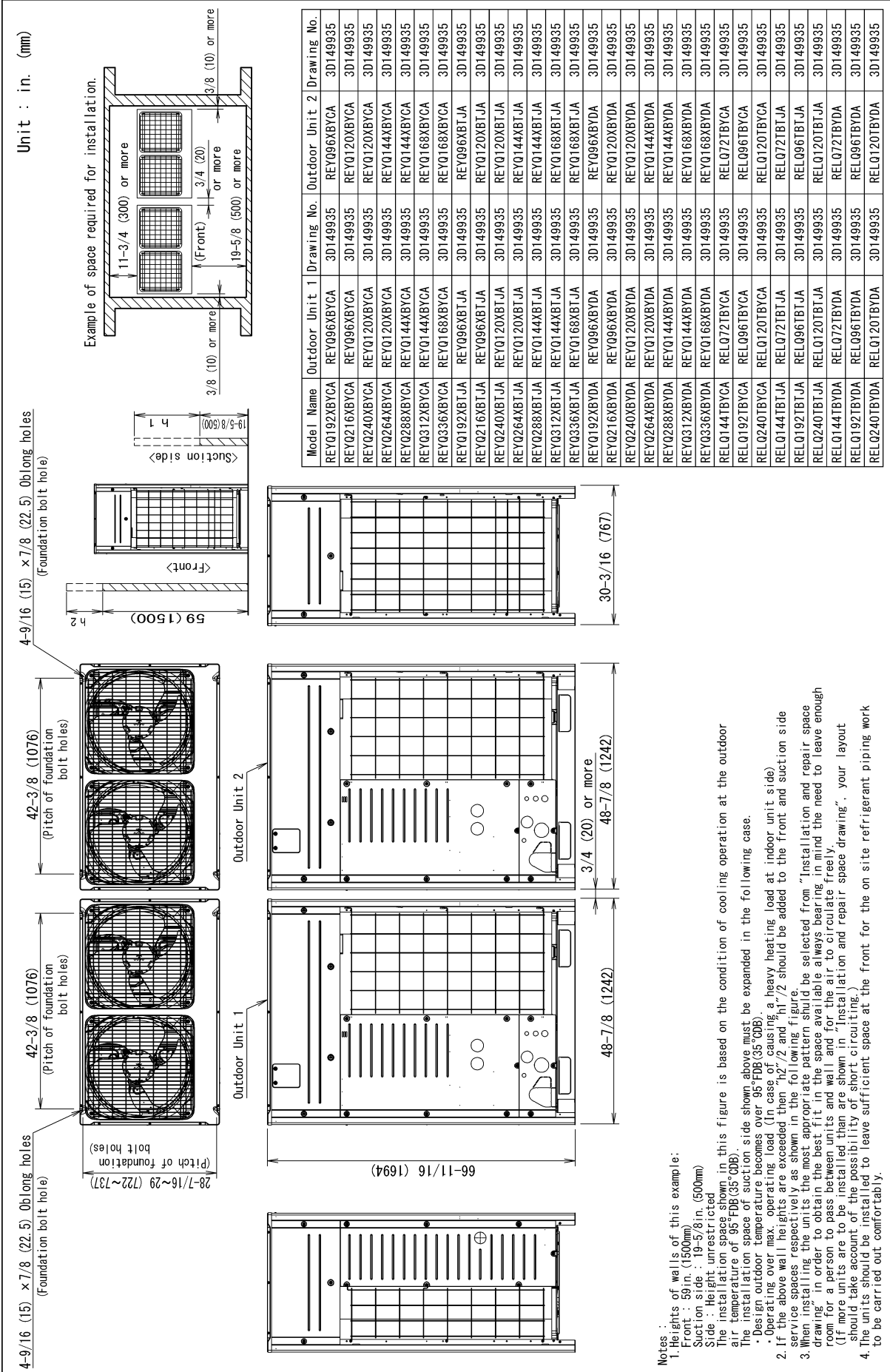

Notes :

1. Heights of walls of this example :
 Front : 59in. (1500mm)
 Suction side : 19-5/8in. (500mm)
 Side : Height unrestricted
 The installation space shown in this figure is based on the condition of cooling operation at the outdoor air temperature of 95°FDB(35°CDB).
 The installation space of suction side shown above must be expanded in the following case.
 • Design outdoor temperature becomes over 95°FDB(35°CDB).
 • Operating over max. operating load (in case of causing a heavy heating load at indoor unit side)
 • If the above wall heights are exceeded then "h2/2" and "h1/2" should be added to the front and suction side service spaces respectively as shown in the following figure.
 2. When installing the units the most appropriate pattern should be selected from "Installation and repair space drawing" in order to obtain the best fit in the space available always bearing in mind the need to leave enough room for a person to pass between units and wall and for the air to circulate freely.
 (If more units are to be installed than are shown in "Installation and repair space drawing", your layout should take account of the possibility of short circuiting.)
 3. The units should be installed to leave sufficient space at the front for the on site refrigerant piping work to be carried out comfortably.

REYQ360 - 456XBTA / XBYDA , REYQ360 - 432XBYCA

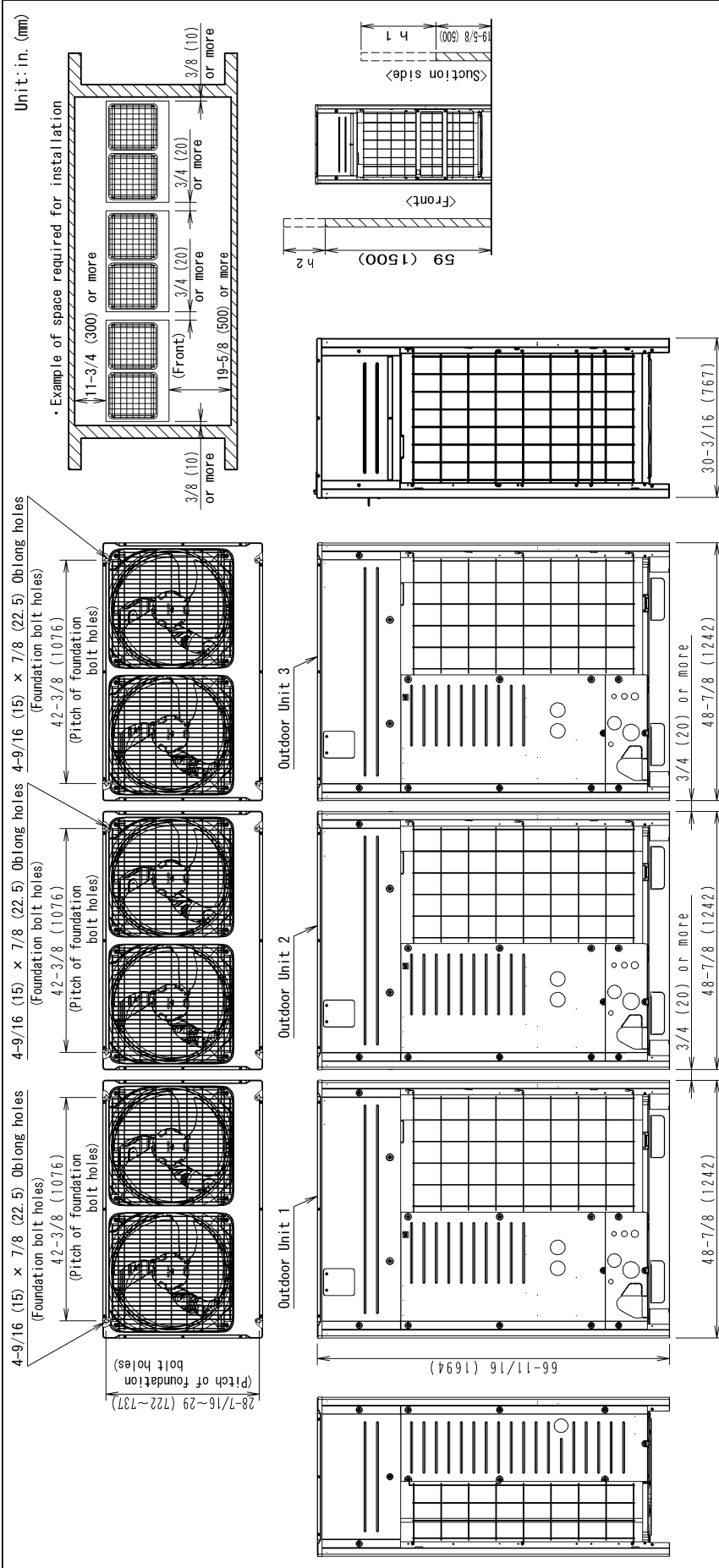

Model Name	Outdoor Unit 1 Drawing No.	Outdoor Unit 2 Drawing No.	Outdoor Unit 3 Drawing No.
REYQ360XBTA	REYQ120XBTA	REYQ120XBTA	REYQ120XBTA
REYQ360XBYCA	REYQ120XBYCA	REYQ120XBYCA	REYQ120XBYCA
REYQ408XBTA	REYQ120XBTA	REYQ120XBTA	REYQ120XBTA
REYQ408XBYCA	REYQ120XBYCA	REYQ120XBYCA	REYQ120XBYCA
REYQ432XBTA	REYQ120XBTA	REYQ120XBTA	REYQ120XBTA
REYQ432XBYCA	REYQ120XBYCA	REYQ120XBYCA	REYQ120XBYCA
REYQ456XBTA	REYQ120XBTA	REYQ120XBTA	REYQ120XBTA
REYQ456XBYCA	REYQ120XBYCA	REYQ120XBYCA	REYQ120XBYCA

Notes:

- Heights of walls of this example:
 - Front : 59 in. (1500mm)
 - Suction side : 19-5/8 in. (500mm)
 - Side : Height unrestricted
 The installation space shown in this figure is based on the condition of cooling operation at the outdoor air temperature of 95°F(35°C).
 - Design-outdoor temperature becomes over 95°F(35°C).
 - Operating over max. operating load (in case of causing a heavy heating load at indoor unit side).
 - If the above wall heights are exceeded then "h2/2" and "h1/2" should be added to the front and suction side service spaces respectively as shown in the following figure.
- When installing the units the most appropriate pattern should be selected from "Installation and repair space drawing" in order to obtain the best fit in the space available always bearing in mind the need to leave enough room for a person to pass between units and wall and for the air to circulate freely.
- If more units are to be installed than are shown in "Installation and repair space drawing", your layout should take account of the possibility of short circuiting.
- The units should be installed to leave sufficient space at the front for the on site refrigerant piping work to be carried out comfortably.

REYQ72 - 456XBTJA/ XBYDA
REYQ72 - 432XBYCA

Unit : in. (mm)

For single unit installation

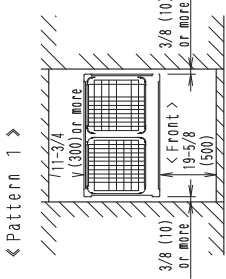

← Pattern 2 →

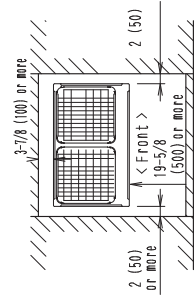

← Pattern 3 →

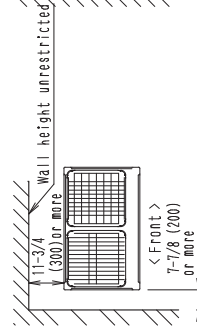

For installation in rows

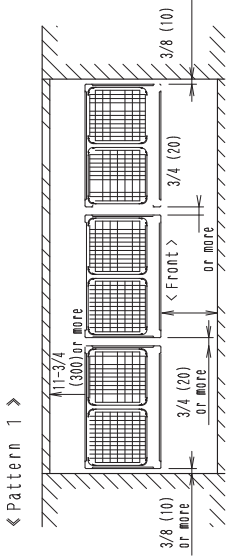

← Pattern 2 →

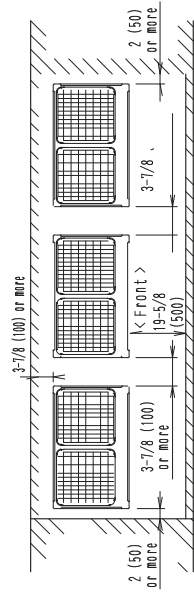

← Pattern 3 →

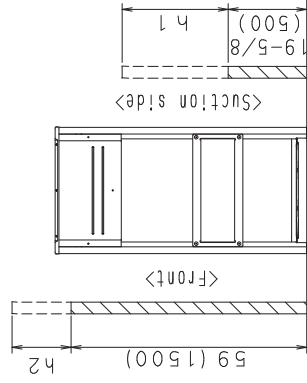
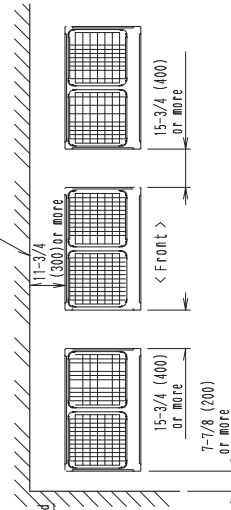

REYQ72 - 456XBTJA / XBYDA
REYQ72 - 432XBYCA

Unit : in. (mm)

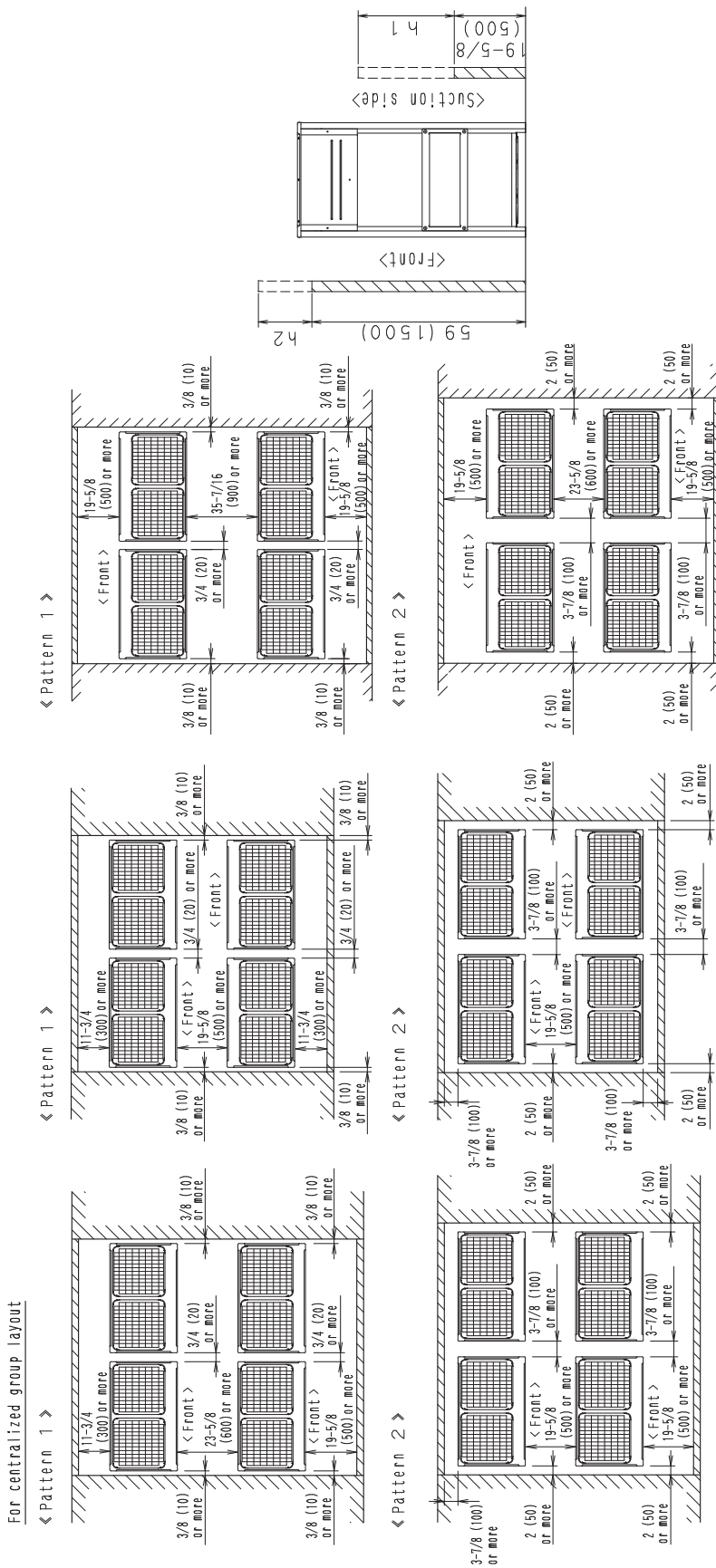

- Notes:**
1. Heights of walls in case of Patterns 1 and 2;
Front : 59 in. (1500 mm)
Suction side : 19-5/8 in. (500 mm)
Side : Height unrestricted
The installation space shown in this figure is based on the condition of cooling operation at the outdoor air temperature of 95°FDB (35°CDB).
The installation space of suction side shown above must be expanded in the following case.
· Design outdoor temperature becomes over 95°FDB (35°CDB).
· Operating over max. operating load (In case of causing a heavy heating load at indoor unit side)
 2. If the above wall heights are exceeded then h2/2 and h1/2 should be added to the front and suction side service spaces respectively as shown in the following figure.
 3. When installing the units the most appropriate pattern should be selected from "Installation and repair space drawing" in order to obtain the best fit in the space available always bearing in mind the need to leave enough room for a person to pass between units and wall and for the air to circulate freely. (If more units are to be installed than are shown in "Installation and repair space drawing", your layout should take account of the possibility of short circuiting.)
 4. The units should be installed to leave sufficient space at the front for the on site refrigerant piping work to be carried out comfortably.

C: 3D085503H

4. Center of Gravity

REYQ72 - 120XBTJA / XBYDA / XBYCA

Unit : in. (mm)

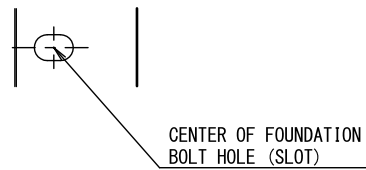
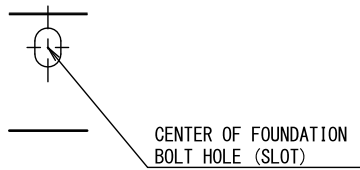
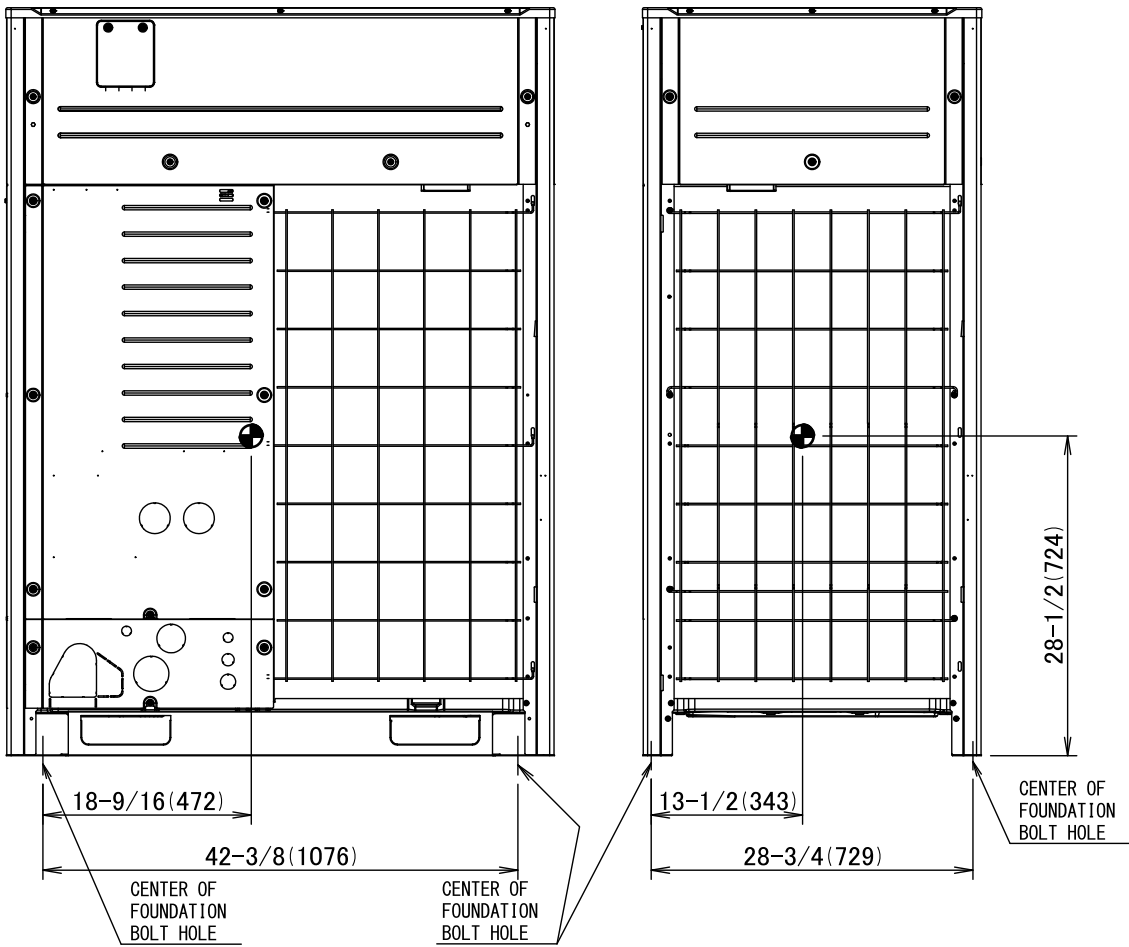

REYQ144 - 168XBTJA / XBYDA / XBYCA

Unit : in. (mm)

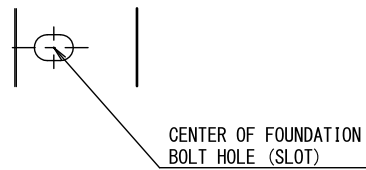
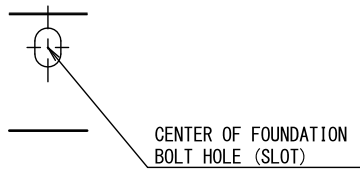
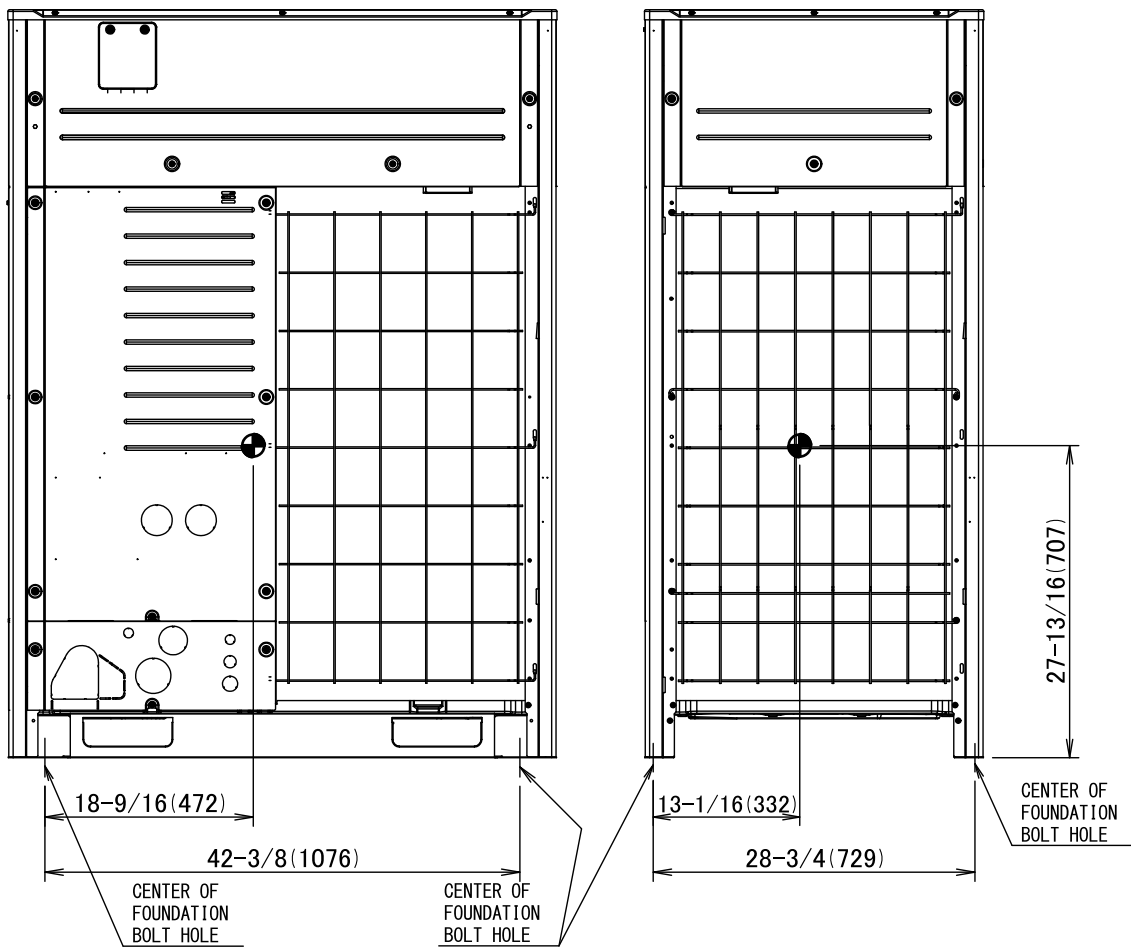

5. Foundation Drawing

REYQ72 - 456XBTJA / XBYDA
 REYQ72 - 432XBYCA

Unit : in. (mm)

Foundation bolt type:JA
 Size: M12
 Four bolts are required

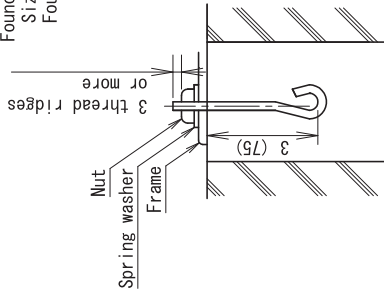

Foundation bolt executing method

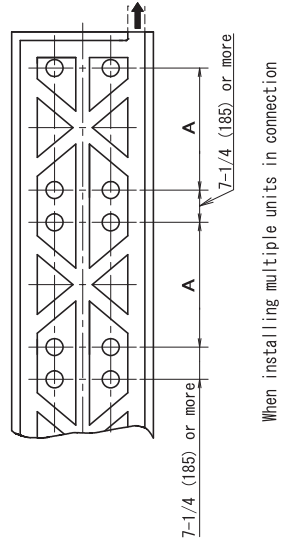

When installing multiple units in connection

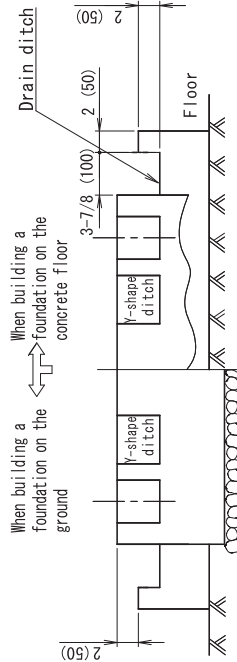
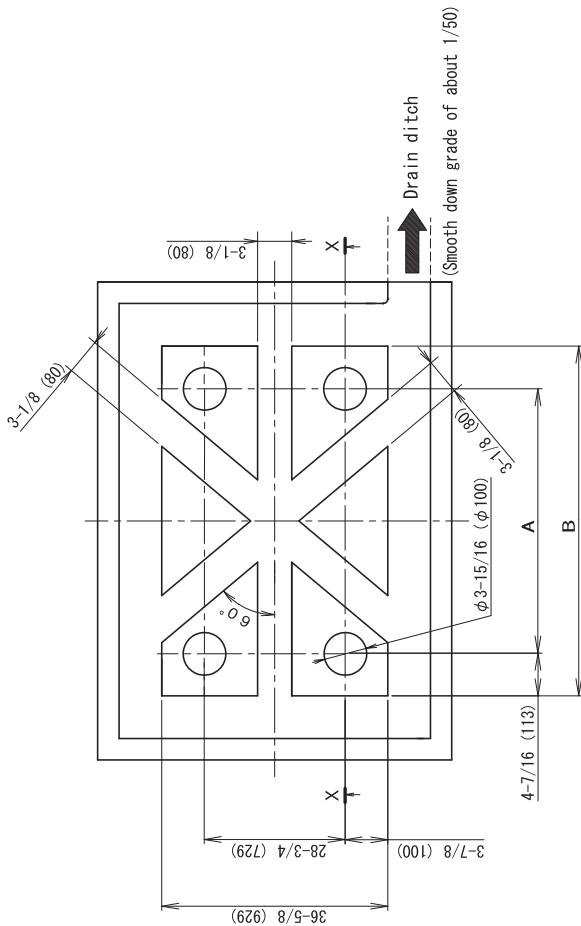

X-X cross section

- (Notes)
1. The proportions of cement:sand:gravel for the concrete shall be 1:2:4, and the reinforcement bars that their diameter are 3/8in (10mm), (approx. 11-3/4in. (300mm) intervals) shall be placed.
 2. The surface shall be finished with mortar. The corner edges shall be chamfered.
 3. When the foundation is built on a concrete floor, rubble is not necessary. However, the surface of the section on which the foundation is built shall have rough finish.
 4. A drain ditch shall be made around the foundation to thoroughly drain water from the equipment installation area.
 5. When installing the equipment on a roof, the floor strength shall be checked, and water-proofing measures shall be taken.

Model	A	B
REYQ72T1JU - REYQ72T1JU • RXYQ72ATJA • RXYQ72ATJA RXYQ72YDN • RXYQ72YDN • RXYQ72AYDA • RXYQ72AYDA RXYQ72XATJA • RXYQ72XAYDA	30-3/16 (766)	39-1/16 (992)
RXYQ96, 120, 144, 168T1JU • RXYQ96, 120, 144, 168T1JU RXYQ96, 120, 144, 168YDN • RXYQ96, 120, 144, 168YDN RXYQ96, 120, 144, 168ATJA • RXYQ96, 120, 144, 168ATJA RXYQ96, 120, 144, 168AYDA • RXYQ96, 120, 144, 168AYDA RELO72, 96, 120, 144, 168AYCA • RXYQ72, 96, 120, 144, 168AYCA RELQ72, 96, 120ATJA • RXLQ72, 96, 120ATJA RELQ72, 96, 120AYDA • RXLQ72, 96, 120AYDA REYQ72, 96, 120, 144, 168XATJB • XAYDB • XAYDB RXYQ96, 120, 144, 168XAYDA RXYQ72, 96, 120, 144, 168XAYCA	42-3/8 (1076)	51-1/4 (1302)

C: 3D085480F

6. Piping Diagrams

REYQ72 - 120XBTJA / XBYDA / XBYCA

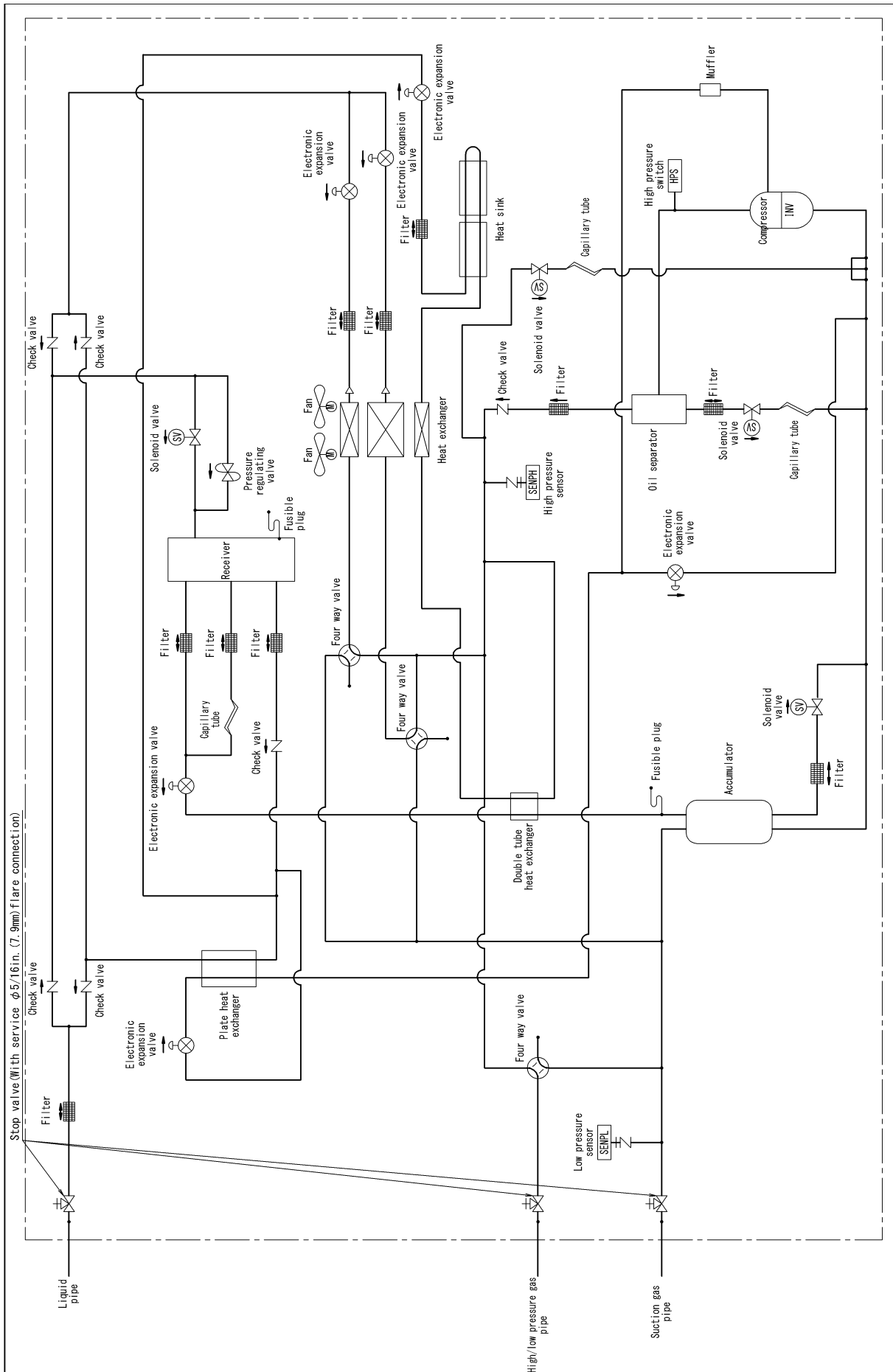

REYQ144 - 168XBTJA / XBYDA / XBYCA

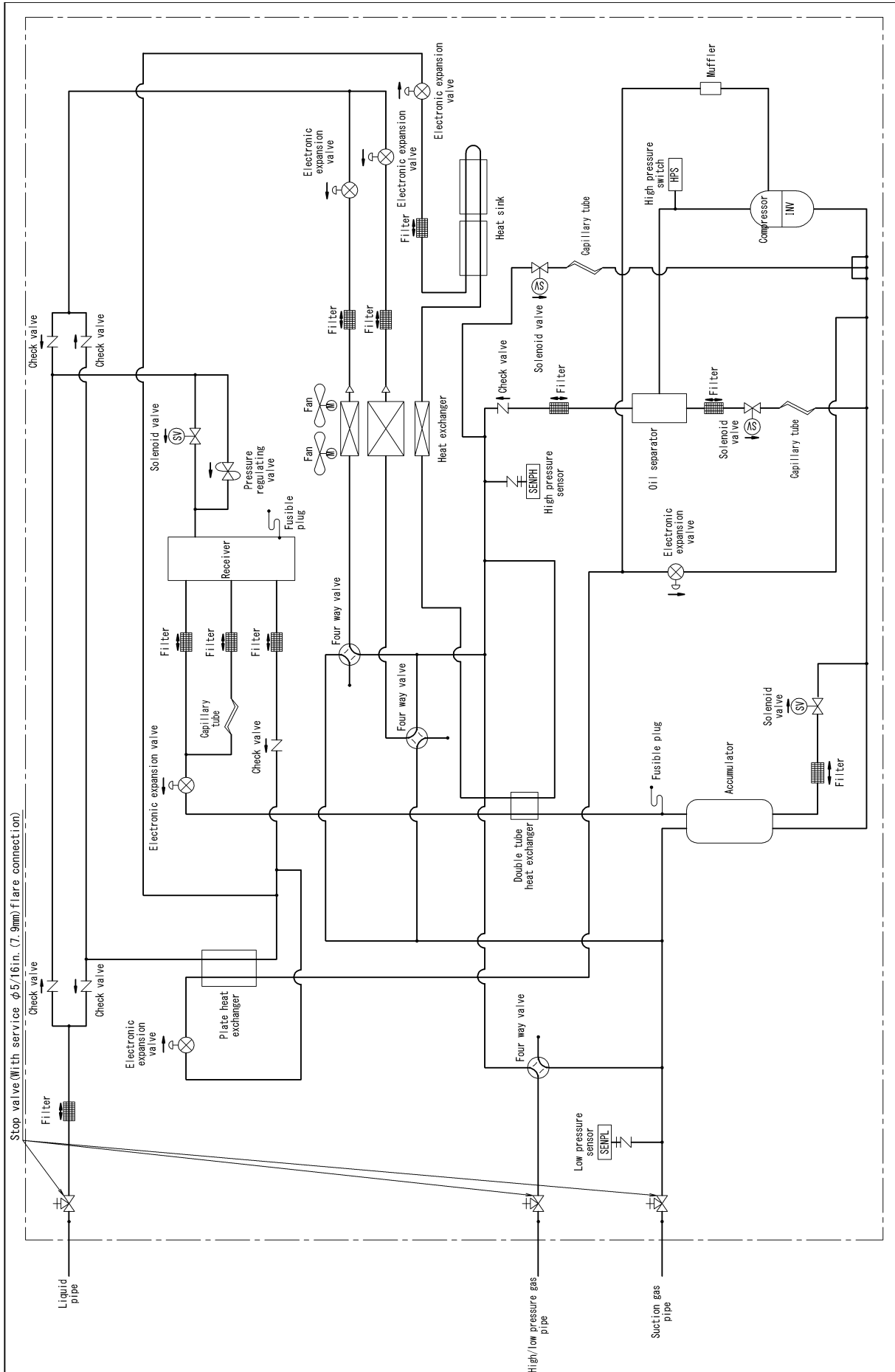

7. Wiring Diagrams

REYQ72 - 120XBTJA

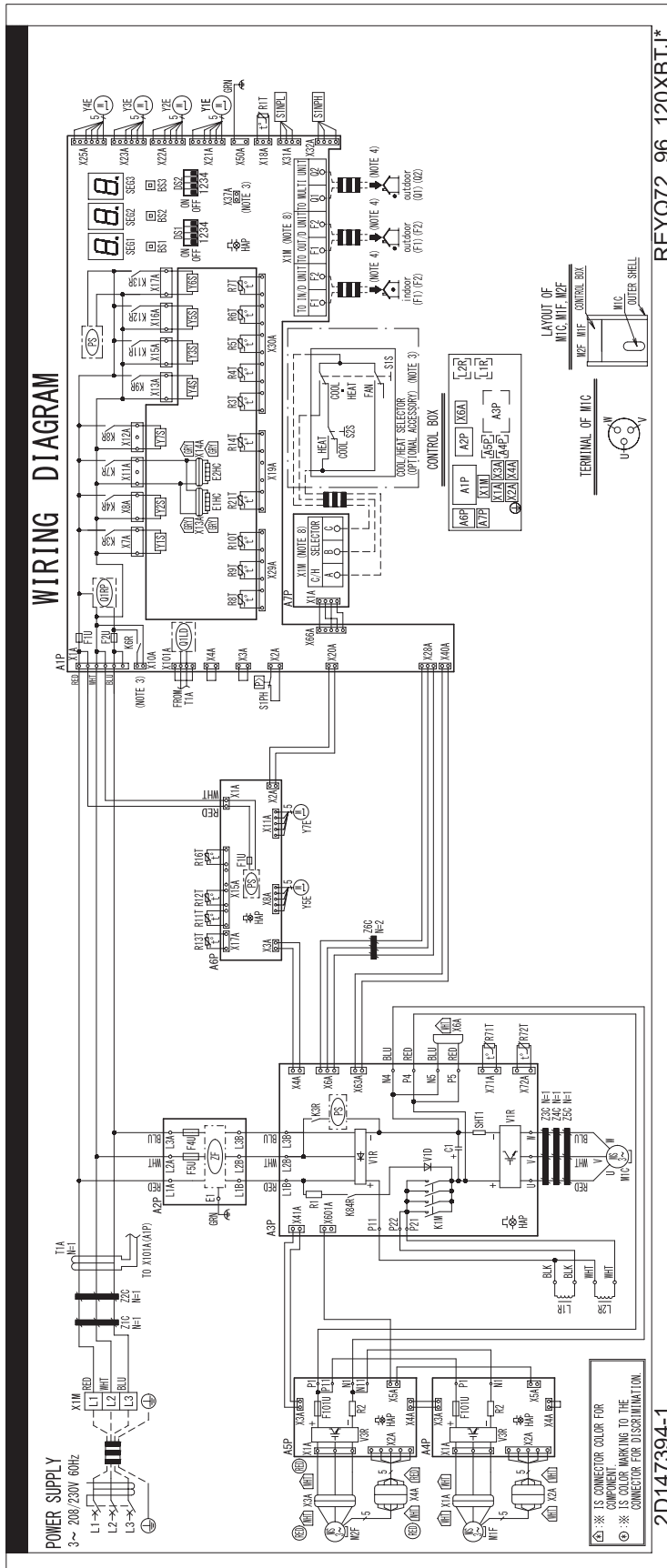

NOTES

1. THIS WIRING DIAGRAM APPLIES ONLY TO THE OUTDOOR UNIT.
2. : FIELD WIRING; : TERMINAL BLOCK, : CONNECTOR, : PROTECTIVE GROUND (SCREW), : NOISELESS GROUND.
3. WHEN USING THE OPTIONAL ADAPTER, REFER TO THE INSTALLATION MANUAL OF THE OPTIONAL ADAPTER.
4. FOR CONNECTION WIRING TO INDOOR-OUTDOOR TRANSMISSION F1-F2, OUTDOOR-OUTDOOR TRANSMISSION F1-F2, OUTDOOR-MULTI TRANSMISSION Q1-Q2, REFER TO THE INSTALLATION MANUAL.
5. HOW TO USE BS1~3 SWITCH, REFER TO "SERVICE PRECAUTIONS" LABEL ON CONTROL BOX COVER.
6. WHEN OPERATING, DON'T SHORTCIRCUIT THE PROTECTION DEVICE (S1PH).
7. COLORS BLK : BLACK ; RED : RED ; BLU : BLUE ; WHT : WHITE ; GRN : GREEN ; GRY : GRAY ; YLW : YELLOW.
8. CLASS 2 WIRE

REYQ72 - 120XBTJA

A1P	PRINTED CIRCUIT BOARD (MAIN)	R11T	THERMISTOR (DEICER)
A2P	PRINTED CIRCUIT BOARD (NOISE FILTER)	R12T	THERMISTOR (COMP. SUCTION)
A3P	PRINTED CIRCUIT BOARD (INV)	R13T	THERMISTOR (RECEIVER GAS PURGE)
A4P, A5P	PRINTED CIRCUIT BOARD (FAN)	R14T	THERMISTOR (M1C BODY)
A6P	PRINTED CIRCUIT BOARD (SUB)	R16T	THERMISTOR (EVT)
A7P	PRINTED CIRCUIT BOARD (ABC I/P)	R21T	THERMISTOR (M1C DISCHARGE)
BS1~BS3	PUSH BUTTON SWITCH (A1P) (MODE, SET, RETURN)	R71T	THERMISTOR (L1R)
C1	CAPACITOR (A3P)	R72T	THERMISTOR (L2R)
DS1, DS2	DIP SWITCH (A1P)	S1NPH	PRESSURE SENSOR (HIGH)
E1HC, E2HC	CRANKCASE HEATER	S1NPL	PRESSURE SENSOR (LOW)
F1U	FUSE (A1P, A6P)	S1PH	PRESSURE SWITCH (HIGH)
F2U	FUSE (A1P)	SEG1~SEG3	7-SEGMENT DISPLAY (A1P)
F101U	FUSE (A4P, A5P)	SHT1	CURRENT SENSOR (A3P)
F4U, F5U	FUSE (A2P)	T1A	CURRENT SENSOR
HAP	PILOTLAMP (A1P, A3P~A6P) (SERVICE MONITOR-GREEN)	V1D	DIODE (A3P)
K3R	MAGNETIC RELAY (A3P)	V1R	POWER MODULE (A3P)
K1M	MAGNETIC CONTACTOR (A3P)	V3R	POWER MODULE (A4P, A5P)
K3R	MAGNETIC RELAY (Y1S) (A1P)	X1A, X2A	CONNECTOR (M1F)
K4R	MAGNETIC RELAY (Y2S) (A1P)	X3A, X4A	CONNECTOR (M2F)
K6R	MAGNETIC RELAY (OPTION) (A1P)	X6A	CONNECTOR (CHECK THE RESIDUAL CHARGE)
K7R	MAGNETIC RELAY (E1HC, E2HC) (A1P)	X13A, X14A	CONNECTOR (E1HC, E2HC)
K8R	MAGNETIC RELAY (Y7S) (A1P)	X1M	TERMINAL BLOCK (POWER SUPPLY)
K9R	MAGNETIC RELAY (Y4S) (A1P)	X1M	TERMINAL BLOCK (CONTROL) (A1P)
K11R	MAGNETIC RELAY (Y3S) (A1P)	X1M	TERMINAL BLOCK (ABC I/P) (A7P)
K12R	MAGNETIC RELAY (Y5S) (A1P)	Y1E	ELECTRIC EXPANSION VALVE (HEAT EXC. UPPER)
K13R	MAGNETIC RELAY (Y6S) (A1P)	Y2E	ELECTRIC EXPANSION VALVE (SUBCOOL HEAT EXC.)
K84R	MAGNETIC RELAY (A3P)	Y3E	ELECTRIC EXPANSION VALVE (HEAT EXC. LOWER)
L1R, L2R	REACTOR	Y4E	ELECTRIC EXPANSION VALVE (INJECTION)
M1C	MOTOR (COMPRESSOR)	Y5E	ELECTRIC EXPANSION VALVE (REFRIGERANT COOLING)
M1F, M2F	MOTOR (FAN)	Y7E	ELECTRIC EXPANSION VALVE (RECEIVER GAS PURGE)
PS	SWITCHING POWER SUPPLY (A1P, A3P, A6P)	Y1S	SOLENOID VALVE (OS OIL RETURN 1)
Q1LD	LEAKAGE DETECTION CIRCUIT (A1P)	Y2S	SOLENOID VALVE (HOT GAS BYPASS)
Q1RP	REVERSE PHASE PROTECTOR CIRCUIT (A1P)	Y3S	SOLENOID VALVE (LIQUID SHUT OFF)
R1	RESISTOR (CURRENT LIMITING) (A3P)	Y4S	4 WAY VALVE (HP/LP GAS)
R2	RESISTOR (CURRENT SENSOR) (A4P, A5P)	Y5S	4 WAY VALVE (HEAT EXC. LOWER)
R1T	THERMISTOR (AIR)	Y6S	4 WAY VALVE (HEAT EXC. UPPER)
R3T	THERMISTOR (RECEIVER INLET)	Y7S	SOLENOID VALVE (ACCUMU OIL RETURN)
R4T	THERMISTOR (HEAT EXC. LIQUID UPPER)	Z1C~Z6C	NOISE FILTER (FERRITE CORE)
R5T	THERMISTOR (HEAT EXC. LIQUID LOWER)	ZF	NOISE FILTER (A2P) (WITH SURGE ABSORBER)
R6T	THERMISTOR (SUBCOOL GAS)	CONNECTOR FOR OPTIONAL ACCESSORIES	
R7T	THERMISTOR (SUBCOOL LIQUID)	X37A	CONNECTOR (POWER ADAPTER) (A1P)
R8T	THERMISTOR (HEAT EXC. GAS UPPER)	COOL/HEAT SELECTOR	
R9T	THERMISTOR (HEAT EXC. GAS LOWER)	S1S	SELECTOR SWITCH (FAN/COOL·HEAT)
R10T	THERMISTOR (SUCTION)	S2S	SELECTOR SWITCH (COOL/HEAT)

C: 2D147394

REYQ144 - 168XBTJA

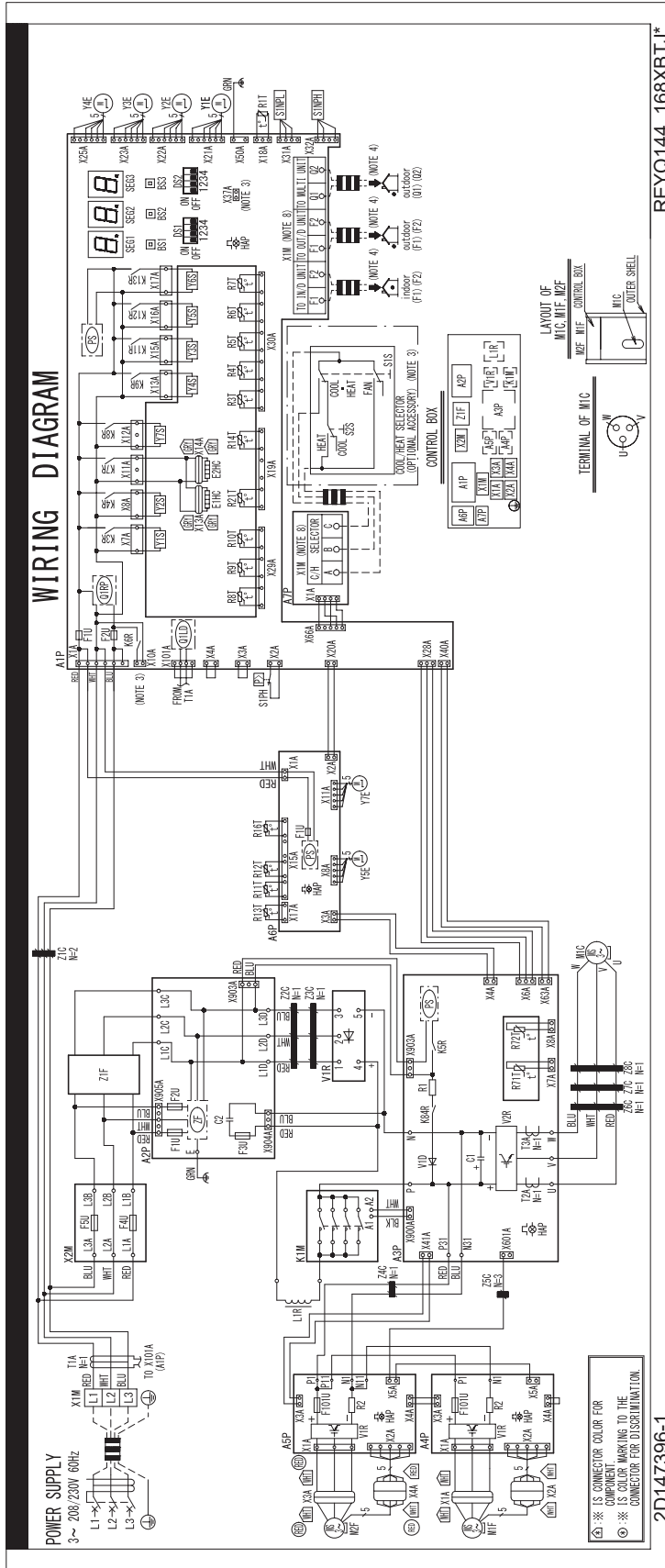

NOTES)

1. THIS WIRING DIAGRAM APPLIES ONLY TO THE OUTDOOR UNIT.
2. : TERMINAL BLOCK, : CONNECTOR, : PROTECTIVE GROUND (SCREW), : NOISELESS GROUND.
3. WHEN USING THE OPTIONAL ADAPTER, REFER TO THE INSTALLATION MANUAL OF THE OPTIONAL ADAPTER.
4. FOR CONNECTION WIRING TO INDOOR-OUTDOOR TRANSMISSION F1-F2, OUTDOOR-OUTDOOR TRANSMISSION F1-F2, OUTDOOR-MULTI TRANSMISSION Q1-Q2, REFER TO THE INSTALLATION MANUAL.
5. HOW TO USE BS1~3 SWITCH, REFER TO "SERVICE PRECAUTIONS" LABEL ON CONTROL BOX COVER.
6. WHEN OPERATING, DON'T SHORTCIRCUIT THE PROTECTION DEVICE (S1PH).
7. COLORS BLK : BLACK ; RED : RED ; BLU : BLUE ; WHT : WHITE ; GRN : GREEN ; GRY : GRAY ; YLW : YELLOW.
8. CLASS 2 WIRE

C: 2D147396

REYQ144 - 168XBTJA

A1P	PRINTED CIRCUIT BOARD (MAIN)	R11T	THERMISTOR (DEICER)
A2P	PRINTED CIRCUIT BOARD (NOISE FILTER)	R12T	THERMISTOR (COMP. SUCTION)
A3P	PRINTED CIRCUIT BOARD (INV)	R13T	THERMISTOR (RECEIVER GAS PURGE)
A4P, A5P	PRINTED CIRCUIT BOARD (FAN)	R14T	THERMISTOR (M1C BODY)
A6P	PRINTED CIRCUIT BOARD (SUB)	R16T	THERMISTOR (EVT)
A7P	PRINTED CIRCUIT BOARD (ABC I/P)	R21T	THERMISTOR (M1C DISCHARGE)
BS1~BS3	PUSH BUTTON SWITCH (A1P) (MODE, SET, RETURN)	R71T	THERMISTOR (POWER MODULE) (A3P)
C1	CAPACITOR (A3P)	R72T	THERMISTOR (DIODE) (A3P)
C2	CAPACITOR (A2P)	S1NPH	PRESSURE SENSOR (HIGH)
DS1, DS2	DIP SWITCH (A1P)	S1NPL	PRESSURE SENSOR (LOW)
E1HC, E2HC	CRANKCASE HEATER	S1PH	PRESSURE SWITCH (HIGH)
F1U	FUSE (A1P, A2P, A6P)	SEG1~SEG3	7-SEGMENT DISPLAY (A1P)
F2U	FUSE (A1P, A2P)	T1A	CURRENT SENSOR
F3U	FUSE (A2P)	T2A, T3A	CURRENT SENSOR (A3P)
F4U, F5U	FUSE (X2M)	V1D	DIODE (A3P)
F101U	FUSE (A4P, A5P)	V1R	DIODE BRIDGE
HAP	PILOTLAMP (A1P, A3P~A6P) (SERVICE MONITOR-GREEN)	V2R	POWER MODULE (A3P)
K1M	MAGNETIC CONTACTOR	V3R	POWER MODULE (A4P, A5P)
K3R	MAGNETIC RELAY (Y1S) (A1P)	X1A, X2A	CONNECTOR (M1F)
K4R	MAGNETIC RELAY (Y2S) (A1P)	X3A, X4A	CONNECTOR (M2F)
K5R	MAGNETIC RELAY (A3P)	X13A, X14A	CONNECTOR (E1HC, E2HC)
K6R	MAGNETIC RELAY (OPTION) (A1P)	X1M	TERMINAL BLOCK (POWER SUPPLY)
K7R	MAGNETIC RELAY (E1HC, E2HC) (A1P)	X1M	TERMINAL BLOCK (CONTROL) (A1P)
K8R	MAGNETIC RELAY (Y7S) (A1P)	X1M	TERMINAL BLOCK (ABC I/P) (A7P)
K9R	MAGNETIC RELAY (Y4S) (A1P)	X2M	TERMINAL BLOCK (FUSE)
K11R	MAGNETIC RELAY (Y3S) (A1P)	Y1E	ELECTRIC EXPANSION VALVE (HEAT EXC. UPPER)
K12R	MAGNETIC RELAY (Y5S) (A1P)	Y2E	ELECTRIC EXPANSION VALVE (SUBCOOL HEAT EXC.)
K13R	MAGNETIC RELAY (Y6S) (A1P)	Y3E	ELECTRIC EXPANSION VALVE (HEAT EXC. LOWER)
K84R	MAGNETIC RELAY (A3P)	Y4E	ELECTRIC EXPANSION VALVE (INJECTION)
L1R	REACTOR	Y5E	ELECTRIC EXPANSION VALVE (REFRIGERANT COOLING)
M1C	MOTOR (COMPRESSOR)	Y7E	ELECTRIC EXPANSION VALVE (RECEIVER GAS PURGE)
M1F, M2F	MOTOR (FAN)	Y1S	SOLENOID VALVE (OS OIL RETURN 1)
PS	SWITCHING POWER SUPPLY (A1P, A3P, A6P)	Y2S	SOLENOID VALVE (HOT GAS BYPASS)
Q1LD	LEAKAGE DETECTION CIRCUIT (A1P)	Y3S	SOLENOID VALVE (LIQUID SHUT OFF)
Q1RP	REVERSE PHASE PROTECTOR CIRCUIT (A1P)	Y4S	4 WAY VALVE (HP/LP GAS)
R1	RESISTOR (CURRENT LIMITING) (A3P)	Y5S	4 WAY VALVE (HEAT EXC. LOWER)
R2	RESISTOR (CURRENT SENSOR) (A4P, A5P)	Y6S	4 WAY VALVE (HEAT EXC. UPPER)
R1T	THERMISTOR (AIR)	Y7S	SOLENOID VALVE (ACCUMU OIL RETURN)
R3T	THERMISTOR (RECEIVER INLET)	Z1C~Z8C	NOISE FILTER (FERRITE CORE)
R4T	THERMISTOR (HEAT EXC. LIQUID UPPER)	Z1F	NOISE FILTER
R5T	THERMISTOR (HEAT EXC. LIQUID LOWER)	ZF	NOISE FILTER (A2P) (WITH SURGE ABSORBER)
R6T	THERMISTOR (SUBCOOL GAS)	CONNECTOR FOR OPTIONAL ACCESSORIES	
R7T	THERMISTOR (SUBCOOL LIQUID)	X37A	CONNECTOR (POWER ADAPTER) (A1P)
R8T	THERMISTOR (HEAT EXC. GAS UPPER)	COOL/HEAT SELECTOR	
R9T	THERMISTOR (HEAT EXC. GAS LOWER)	S1S	SELECTOR SWITCH (FAN/COOL·HEAT)
R10T	THERMISTOR (SUCTION)	S2S	SELECTOR SWITCH (COOL/HEAT)

C: 2D147396

REYQ72 - 120XBYDA

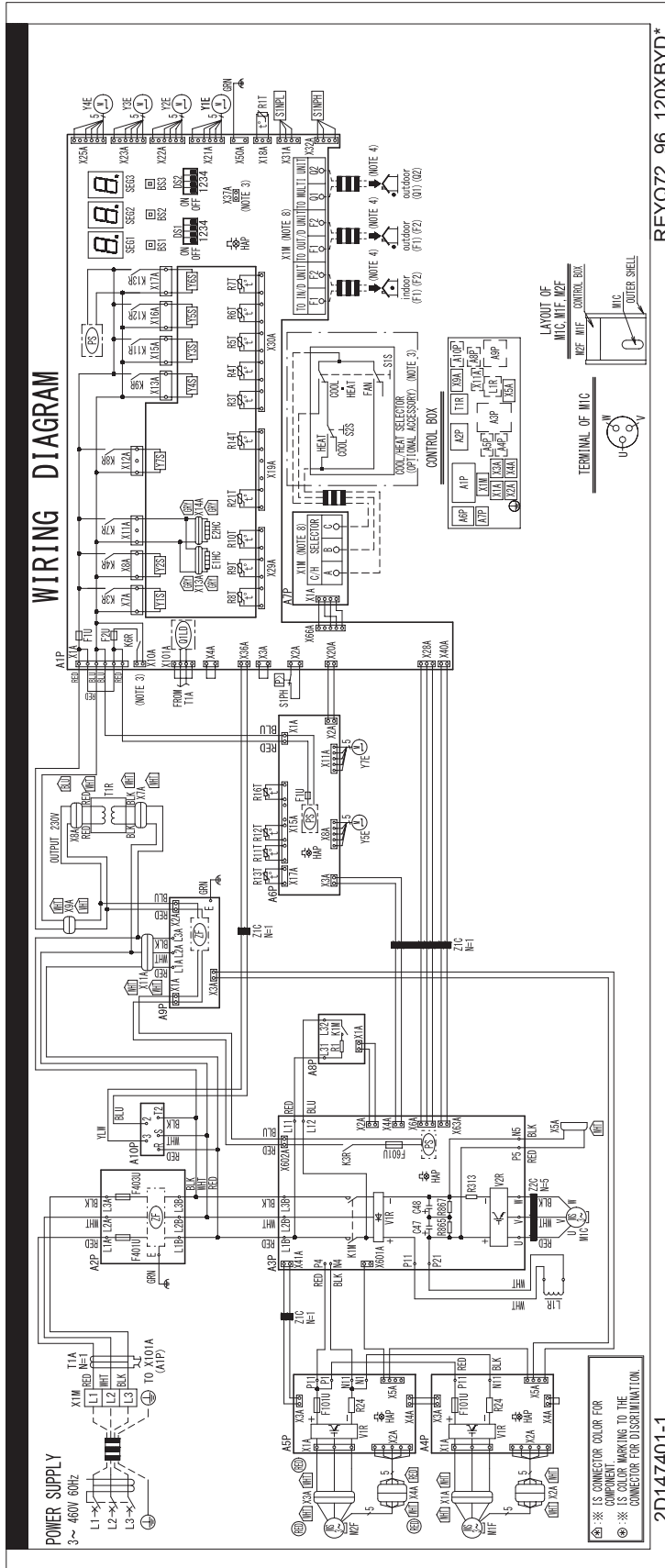

REYQ72-96-120XBYD*

2D147401-1

NOTES

1. THIS WIRING DIAGRAM APPLIES ONLY TO THE OUTDOOR UNIT.
2. : FIELD WIRING; : TERMINAL BLOCK; : CONNECTOR, : TERMINAL, : PROTECTIVE GROUND (SCREW), : NOISELESS GROUND.
3. WHEN USING THE OPTIONAL ADAPTER, REFER TO THE INSTALLATION MANUAL OF THE OPTIONAL ADAPTER.
4. FOR CONNECTION WIRING TO INDOOR-OUTDOOR TRANSMISSION F1-F2, OUTDOOR-OUTDOOR TRANSMISSION F1-F2, OUTDOOR-MULTI TRANSMISSION Q1-Q2, REFER TO THE INSTALLATION MANUAL.
5. HOW TO USE BS1-3 SWITCH, REFER TO "SERVICE PRECAUTIONS" LABEL ON CONTROL BOX COVER.
6. WHEN OPERATING, DON'T SHORTCIRCUIT THE PROTECTION DEVICE (S1PH).
7. COLORS BLK : BLACK ; RED : RED ; WHT : WHITE ; GRN : GREEN ; YLW : YELLOW.
8. CLASS 2 WIRE

C: 2D147401

REYQ72 - 120XBYDA

A1P	PRINTED CIRCUIT BOARD (MAIN)	R9T	THERMISTOR (HEAT EXC. GAS LOWER)
A2P	PRINTED CIRCUIT BOARD (NOISE FILTER)	R10T	THERMISTOR (SUCTION)
A3P	PRINTED CIRCUIT BOARD (INV)	R11T	THERMISTOR (DEICER)
A4P, A5P	PRINTED CIRCUIT BOARD (FAN)	R12T	THERMISTOR (COMP. SUCTION)
A6P	PRINTED CIRCUIT BOARD (SUB)	R13T	THERMISTOR (RECEIVER GAS PURGE)
A7P	PRINTED CIRCUIT BOARD (ABC I/P)	R14T	THERMISTOR (M1C BODY)
A8P	PRINTED CIRCUIT BOARD (CURRENT LIMITING)	R16T	THERMISTOR (EVT)
A9P	PRINTED CIRCUIT BOARD (NOISE FILTER)	R21T	THERMISTOR (M1C DISCHARGE)
A10P	PRINTED CIRCUIT BOARD (OPEN PHASE PROTECTION)	S1NPH	PRESSURE SENSOR (HIGH)
BS1~BS3	PUSH BUTTON SWITCH (A1P) (MODE, SET, RETURN)	S1NPL	PRESSURE SENSOR (LOW)
C47, C48	CAPACITOR (A3P)	S1PH	PRESSURE SWITCH (HIGH)
DS1, DS2	DIP SWITCH (A1P)	SEG1~SEG3	7-SEGMENT DISPLAY (A1P)
E1HC, E2HC	CRANKCASE HEATER	T1A	CURRENT SENSOR
F1U	FUSE (A1P, A6P)	T1R	TRANSFORMER (460 V / 230 V)
F2U	FUSE (A1P)	V1R	DIODE BRIDGE (A3P)
F101U	FUSE (A4P, A5P)	V1R	POWER MODULE (A4P, A5P)
F401U, F403U	FUSE (A2P)	V2R	POWER MODULE (A3P)
F601U	FUSE (A3P)	X1A, X2A	CONNECTOR (M1F)
HAP	PILOTLAMP (A1P, A3P~A6P) (SERVICE MONITOR-GREEN)	X3A, X4A	CONNECTOR (M2F)
K1M	MAGNETIC CONTACTOR (A3P)	X5A	CONNECTOR (CHECK THE RESIDUAL CHARGE)
K1M	MAGNETIC CONTACTOR (A8P)	X7A, X8A	CONNECTOR (T1R)
K3R	MAGNETIC RELAY (A3P)	X9A, X11A	CONNECTOR
K3R	MAGNETIC RELAY (Y1S) (A1P)	X13A, X14A	CONNECTOR (E1HC, E2HC)
K4R	MAGNETIC RELAY (Y2S) (A1P)	X1M	TERMINAL BLOCK (POWER SUPPLY)
K6R	MAGNETIC RELAY (OPTION) (A1P)	X1M	TERMINAL BLOCK (CONTROL) (A1P)
K7R	MAGNETIC RELAY (E1HC, E2HC) (A1P)	X1M	TERMINAL BLOCK (ABC I/P) (A7P)
K8R	MAGNETIC RELAY (Y7S) (A1P)	Y1E	ELECTRIC EXPANSION VALVE (HEAT EXC. UPPER)
K9R	MAGNETIC RELAY (Y4S) (A1P)	Y2E	ELECTRIC EXPANSION VALVE (SUBCOOL HEAT EXC.)
K11R	MAGNETIC RELAY (Y3S) (A1P)	Y3E	ELECTRIC EXPANSION VALVE (HEAT EXC. LOWER)
K12R	MAGNETIC RELAY (Y5S) (A1P)	Y4E	ELECTRIC EXPANSION VALVE (INJECTION)
K13R	MAGNETIC RELAY (Y6S) (A1P)	Y5E	ELECTRIC EXPANSION VALVE (REFRIGERANT COOLING)
L1R	REACTOR	Y7E	ELECTRIC EXPANSION VALVE (RECEIVER GAS PURGE)
M1C	MOTOR (COMPRESSOR)	Y1S	SOLENOID VALVE (OS OIL RETURN 1)
M1F, M2F	MOTOR (FAN)	Y2S	SOLENOID VALVE (HOT GAS BYPASS)
PS	SWITCHING POWER SUPPLY (A1P, A3P, A6P)	Y3S	SOLENOID VALVE (LIQUID SHUT OFF)
Q1LD	LEAKAGE DETECTION CIRCUIT (A1P)	Y4S	4 WAY VALVE (HP/LP GAS)
R1	RESISTOR (CURRENT LIMITING) (A8P)	Y5S	4 WAY VALVE (HEAT EXC. LOWER)
R24	RESISTOR (CURRENT SENSOR) (A4P, A5P)	Y6S	4 WAY VALVE (HEAT EXC. UPPER)
R313	RESISTOR (CURRENT SENSOR) (A3P)	Y7S	SOLENOID VALVE (ACCUMU OIL RETURN)
R865, R867	RESISTOR (A3P)	Z1C, Z2C	NOISE FILTER (FERRITE CORE)
R1T	THERMISTOR (AIR)	ZF	NOISE FILTER (A2P, A9P) (WITH SURGE ABSORBER)
R3T	THERMISTOR (RECEIVER INLET)	CONNECTOR FOR OPTIONAL ACCESSORIES	
R4T	THERMISTOR (HEAT EXC. LIQUID UPPER)	X37A	CONNECTOR (POWER ADAPTER) (A1P)
R5T	THERMISTOR (HEAT EXC. LIQUID LOWER)	COOL/HEAT SELECTOR	
R6T	THERMISTOR (SUBCOOL GAS)	S1S	SELECTOR SWITCH (FAN/COOL·HEAT)
R7T	THERMISTOR (SUBCOOL LIQUID)	S2S	SELECTOR SWITCH (COOL/HEAT)
R8T	THERMISTOR (HEAT EXC. GAS UPPER)		

C: 2D147401

REYQ144 - 168XBYDA

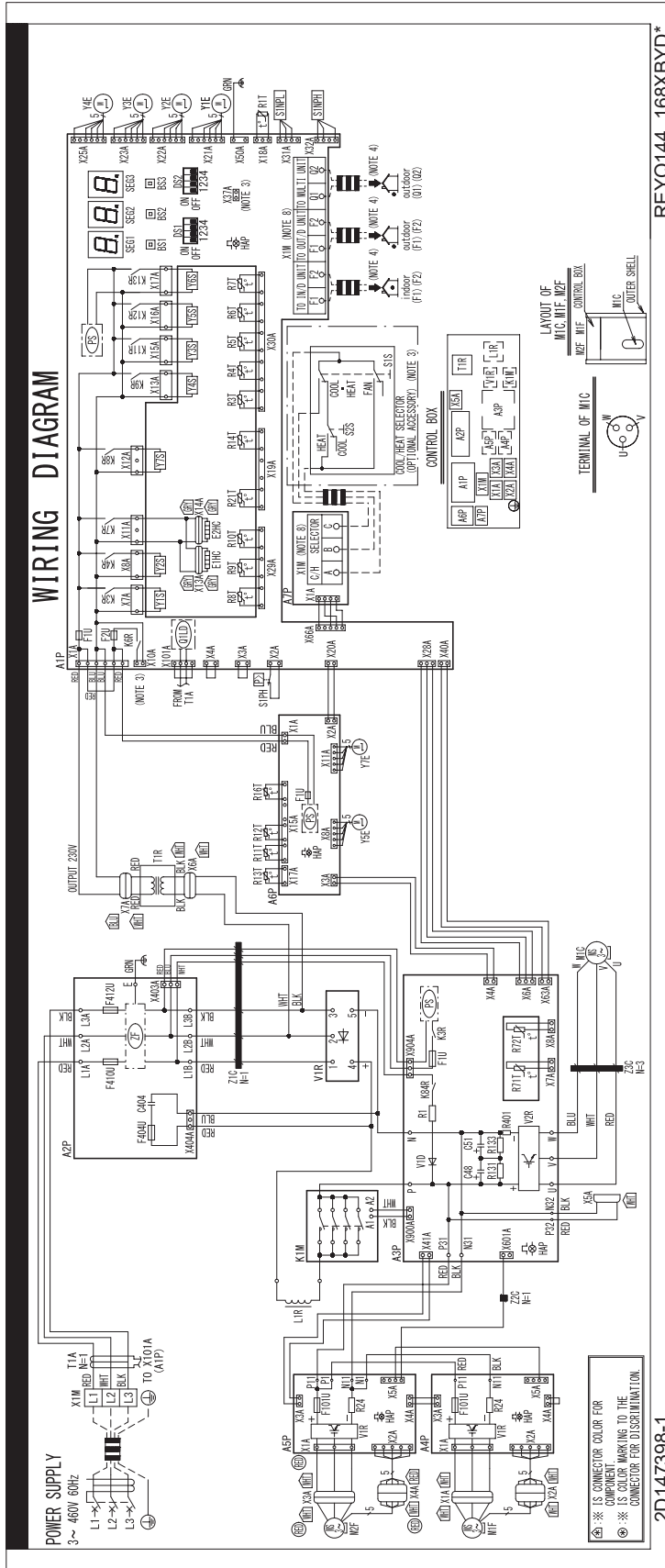

NOTES)

1. THIS WIRING DIAGRAM APPLIES ONLY TO THE OUTDOOR UNIT.
2. : FIELD WIRING. : TERMINAL BLOCK, : CONNECTOR.
3. WHEN USING THE OPTIONAL ADAPTER, REFER TO THE INSTALLATION MANUAL OF THE OPTIONAL ADAPTER.
4. FOR CONNECTION WIRING TO INDOOR-OUTDOOR TRANSMISSION F1-F2, OUTDOOR-OUTDOOR TRANSMISSION F1-F2, OUTDOOR-MULTI TRANSMISSION Q1-Q2, REFER TO THE INSTALLATION MANUAL.
5. HOW TO USE BS1-3 SWITCH, REFER TO "SERVICE PRECAUTIONS" LABEL ON CONTROL BOX COVER.
6. WHEN OPERATING, DON'T SHORTCIRCUIT THE PROTECTION DEVICE (S1PH).
7. COLORS BLK : BLACK ; RED : RED ; BLU : BLUE ; WHT : WHITE ; GRN : GREEN ; GRY : GRAY ; YLW : YELLOW.
8. CLASS 2 WIRE

REYQ144 - 168XBYDA

A1P	PRINTED CIRCUIT BOARD (MAIN)	R11T	THERMISTOR (DEICER)
A2P	PRINTED CIRCUIT BOARD (NOISE FILTER)	R12T	THERMISTOR (COMP. SUCTION)
A3P	PRINTED CIRCUIT BOARD (INV)	R13T	THERMISTOR (RECEIVER GAS PURGE)
A4P, A5P	PRINTED CIRCUIT BOARD (FAN)	R14T	THERMISTOR (M1C BODY)
A6P	PRINTED CIRCUIT BOARD (SUB)	R16T	THERMISTOR (EVT)
A7P	PRINTED CIRCUIT BOARD (ABC I/P)	R21T	THERMISTOR (M1C DISCHARGE)
BS1~BS3	PUSH BUTTON SWITCH (A1P) (MODE, SET, RETURN)	R71T	THERMISTOR (POWER MODULE) (A3P)
C48, C51	CAPACITOR (A3P)	R72T	THERMISTOR (DIODE) (A3P)
C404	CAPACITOR (A2P)	S1NPH	PRESSURE SENSOR (HIGH)
DS1, DS2	DIP SWITCH (A1P)	S1NPL	PRESSURE SENSOR (LOW)
E1HC, E2HC	CRANKCASE HEATER	S1PH	PRESSURE SWITCH (HIGH)
F1U	FUSE (A1P, A3P, A6P)	SEG1~SEG3	7-SEGMENT DISPLAY (A1P)
F2U	FUSE (A1P)	T1A	CURRENT SENSOR
F101U	FUSE (A4P, A5P)	T1R	TRANSFORMER (460 V / 230 V)
F404U	FUSE (A2P)	V1D	DIODE (CURRENT LIMITING) (A3P)
F410U, F412U	FUSE (A2P)	V1R	DIODE BRIDGE
HAP	PILOTLAMP (A1P, A3P~A6P) (SERVICE MONITOR-GREEN)	V1R	POWER MODULE (A4P, A5P)
K1M	MAGNETIC CONTACTOR	V2R	POWER MODULE (A3P)
K3R	MAGNETIC RELAY (A3P)	X1A, X2A	CONNECTOR (M1F)
K3R	MAGNETIC RELAY (Y1S) (A1P)	X3A, X4A	CONNECTOR (M2F)
K4R	MAGNETIC RELAY (Y2S) (A1P)	X5A	CONNECTOR (CHECK THE RESIDUAL CHARGE)
K6R	MAGNETIC RELAY (OPTION) (A1P)	X6A, X7A	CONNECTOR (T1R)
K7R	MAGNETIC RELAY (E1HC, E2HC) (A1P)	X13A, X14A	CONNECTOR (E1HC, E2HC)
K8R	MAGNETIC RELAY (Y7S) (A1P)	X1M	TERMINAL BLOCK (POWER SUPPLY)
K9R	MAGNETIC RELAY (Y4S) (A1P)	X1M	TERMINAL BLOCK (CONTROL) (A1P)
K11R	MAGNETIC RELAY (Y3S) (A1P)	X1M	TERMINAL BLOCK (ABC I/P) (A7P)
K12R	MAGNETIC RELAY (Y5S) (A1P)	Y1E	ELECTRIC EXPANSION VALVE (HEAT EXC. UPPER)
K13R	MAGNETIC RELAY (Y6S) (A1P)	Y2E	ELECTRIC EXPANSION VALVE (SUBCOOL HEAT EXC.)
K84R	MAGNETIC RELAY (A3P)	Y3E	ELECTRIC EXPANSION VALVE (HEAT EXC. LOWER)
L1R	REACTOR	Y4E	ELECTRIC EXPANSION VALVE (INJECTION)
M1C	MOTOR (COMPRESSOR)	Y5E	ELECTRIC EXPANSION VALVE (REFRIGERANT COOLING)
M1F, M2F	MOTOR (FAN)	Y7E	ELECTRIC EXPANSION VALVE (RECEIVER GAS PURGE)
PS	SWITCHING POWER SUPPLY (A1P, A3P, A6P)	Y1S	SOLENOID VALVE (OS OIL RETURN 1)
Q1LD	LEAKAGE DETECTION CIRCUIT (A1P)	Y2S	SOLENOID VALVE (HOT GAS BYPASS)
R1	RESISTOR (CURRENT LIMITING) (A3P)	Y3S	SOLENOID VALVE (LIQUID SHUT OFF)
R24	RESISTOR (CURRENT SENSOR) (A4P, A5P)	Y4S	4 WAY VALVE (HP/LP GAS)
R131, R133	RESISTOR (A3P)	Y5S	4 WAY VALVE (HEAT EXC. LOWER)
R401	RESISTOR (CURRENT SENSOR) (A3P)	Y6S	4 WAY VALVE (HEAT EXC. UPPER)
R1T	THERMISTOR (AIR)	Y7S	SOLENOID VALVE (ACCUMU OIL RETURN)
R3T	THERMISTOR (RECEIVER INLET)	Z1C~Z3C	NOISE FILTER (FERRITE CORE)
R4T	THERMISTOR (HEAT EXC. LIQUID UPPER)	ZF	NOISE FILTER (A2P) (WITH SURGE ABSORBER)
R5T	THERMISTOR (HEAT EXC. LIQUID LOWER)		CONNECTOR FOR OPTIONAL ACCESSORIES
R6T	THERMISTOR (SUBCOOL GAS)	X37A	CONNECTOR (POWER ADAPTER) (A1P)
R7T	THERMISTOR (SUBCOOL LIQUID)		COOL/HEAT SELECTOR
R8T	THERMISTOR (HEAT EXC. GAS UPPER)	S1S	SELECTOR SWITCH (FAN/COOL-HEAT)
R9T	THERMISTOR (HEAT EXC. GAS LOWER)	S2S	SELECTOR SWITCH (COOL/HEAT)
R10T	THERMISTOR (SUCTION)		

C: 2D147398

REYQ72 - 168XBYCA

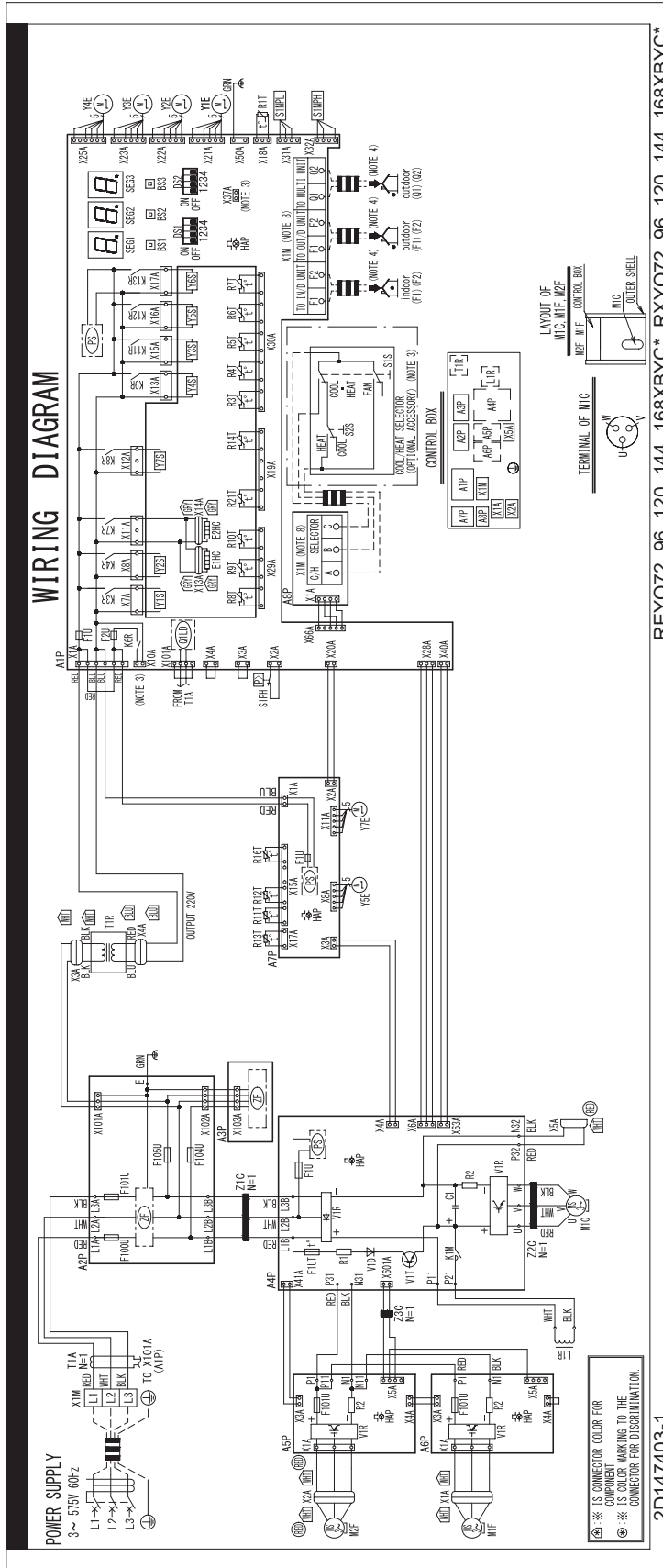

REYQ72; 96, 120, 144, 168XBYC* RXYQ72; 96, 120, 144, 168XBYC*

NOTES)

1. THIS WIRING DIAGRAM APPLIES ONLY TO THE OUTDOOR UNIT.
2. : FIELD WIRING; : TERMINAL BLOCK, : CONNECTOR, : TERMINAL, : PROTECTIVE GROUND (SCREW), : NOISELESS GROUND.
3. WHEN USING THE OPTIONAL ADAPTER, REFER TO THE INSTALLATION MANUAL OF THE OPTIONAL ADAPTER.
4. FOR CONNECTION WIRING TO INDOOR-OUTDOOR TRANSMISSION F1-F2, OUTDOOR-OUTDOOR TRANSMISSION F1-F2, OUTDOOR-MULTI TRANSMISSION Q1-Q2, REFER TO THE INSTALLATION MANUAL.
5. HOW TO USE BS1-3 SWITCH, REFER TO "SERVICE PRECAUTIONS" LABEL ON CONTROL BOX COVER.
6. WHEN OPERATING, DON'T SHORTCIRCUIT THE PROTECTION DEVICE (S1PH).
7. COLORS BLK : BLACK ; RED : RED ; BLU : BLUE ; WHT : WHITE ; GRN : GREEN ; GRY : GRAY ; YLW : YELLOW.
8. CLASS 2 WIRE

C: 2D147403

REYQ72 - 168XBYCA

A1P	PRINTED CIRCUIT BOARD (MAIN)	R11T	THERMISTOR (DEICER)
A2P, A3P	PRINTED CIRCUIT BOARD (NOISE FILTER)	R12T	THERMISTOR (COMP. SUCTION)
A4P	PRINTED CIRCUIT BOARD (INV)	R13T	THERMISTOR (RECEIVER GAS PURGE)
A5P, A6P	PRINTED CIRCUIT BOARD (FAN)	R14T	THERMISTOR (M1C BODY)
A7P	PRINTED CIRCUIT BOARD (SUB)	R16T	THERMISTOR (EVT)
A8P	PRINTED CIRCUIT BOARD (ABC I/P)	R21T	THERMISTOR (M1C DISCHARGE)
BS1~BS3	PUSH BUTTON SWITCH (A1P) (MODE, SET, RETURN)	S1NPH	PRESSURE SENSOR (HIGH)
C1	CAPACITOR (A4P)	S1NPL	PRESSURE SENSOR (LOW)
DS1, DS2	DIP SWITCH (A1P)	S1PH	PRESSURE SWITCH (HIGH)
E1HC, E2HC	CRANKCASE HEATER	SEG1~SEG3	7-SEGMENT DISPLAY (A1P)
F1U	FUSE (A1P, A4P, A7P)	T1A	CURRENT SENSOR
F2U	FUSE (A1P)	T1R	TRANSFORMER (575 V / 220 V)
F101U	FUSE (A2P, A5P, A6P)	V1D	DIODE (A4P)
F100U, F104U, F105U	FUSE (A2P)	V1R	POWER MODULE (A4P)
		V1R	POWER MODULE (A5P, A6P)
F1UT	THERMAL FUSE (A4P)	V1T	TRANSISTOR (A4P)
HAP	PILOTLAMP (A1P, A4P~A7P) (SERVICE MONITOR-GREEN)	X1A, X2A	CONNECTOR (M1F, M2F)
K1M	MAGNETIC CONTACTOR (A4P)	X5A	CONNECTOR (CHECK THE RESIDUAL CHARGE)
K3R	MAGNETIC RELAY (Y1S) (A1P)	X3A, X4A	CONNECTOR (T1R)
K4R	MAGNETIC RELAY (Y2S) (A1P)	X13A, X14A	CONNECTOR (E1HC, E2HC)
K6R	MAGNETIC RELAY (OPTION) (A1P)	X1M	TERMINAL BLOCK (POWER SUPPLY)
K7R	MAGNETIC RELAY (E1HC, E2HC) (A1P)	X1M	TERMINAL BLOCK (CONTROL) (A1P)
K8R	MAGNETIC RELAY (Y7S) (A1P)	X1M	TERMINAL BLOCK (ABC I/P) (A8P)
K9R	MAGNETIC RELAY (Y4S) (A1P)	Y1E	ELECTRIC EXPANSION VALVE (HEAT EXC. UPPER)
K11R	MAGNETIC RELAY (Y3S) (A1P)	Y2E	ELECTRIC EXPANSION VALVE (SUBCOOL HEAT EXC.)
K12R	MAGNETIC RELAY (Y5S) (A1P)	Y3E	ELECTRIC EXPANSION VALVE (HEAT EXC. LOWER)
K13R	MAGNETIC RELAY (Y6S) (A1P)	Y4E	ELECTRIC EXPANSION VALVE (INJECTION)
L1R	REACTOR	Y5E	ELECTRIC EXPANSION VALVE (REFRIGERANT COOLING)
M1C	MOTOR (COMPRESSOR)	Y7E	ELECTRIC EXPANSION VALVE (RECEIVER GAS PURGE)
M1F, M2F	MOTOR (FAN)	Y1S	SOLENOID VALVE (OS OIL RETURN 1)
PS	SWITCHING POWER SUPPLY (A1P, A4P, A7P)	Y2S	SOLENOID VALVE (HOT GAS BYPASS)
Q1LD	LEAKAGE DETECTION CIRCUIT (A1P)	Y3S	SOLENOID VALVE (LIQUID SHUT OFF)
R1	RESISTOR (CURRENT LIMITING) (A4P)	Y4S	4 WAY VALVE (HP/LP GAS)
R2	RESISTOR (CURRENT SENSOR) (A4P, A5P, A6P)	Y5S	4 WAY VALVE (HEAT EXC. LOWER)
R1T	THERMISTOR (AIR)	Y6S	4 WAY VALVE (HEAT EXC. UPPER)
R3T	THERMISTOR (RECEIVER INLET)	Y7S	SOLENOID VALVE (ACCUMU OIL RETURN)
R4T	THERMISTOR (HEAT EXC. LIQUID UPPER)	Z1C~Z3C	NOISE FILTER (FERRITE CORE)
R5T	THERMISTOR (HEAT EXC. LIQUID LOWER)	ZF	NOISE FILTER (A2P, A3P) (WITH SURGE ABSORBER)
R6T	THERMISTOR (SUBCOOL GAS)		CONNECTOR FOR OPTIONAL ACCESSORIES
R7T	THERMISTOR (SUBCOOL LIQUID)	X37A	CONNECTOR (POWER ADAPTER) (A1P)
R8T	THERMISTOR (HEAT EXC. GAS UPPER)		COOL/HEAT SELECTOR
R9T	THERMISTOR (HEAT EXC. GAS LOWER)	S1S	SELECTOR SWITCH (FAN/COOL·HEAT)
R10T	THERMISTOR (SUCTION)	S2S	SELECTOR SWITCH (COOL/HEAT)

C: 2D147403

8. Field Wiring

REYQ72 - 168XBTJA / XBYDA / XBYCA

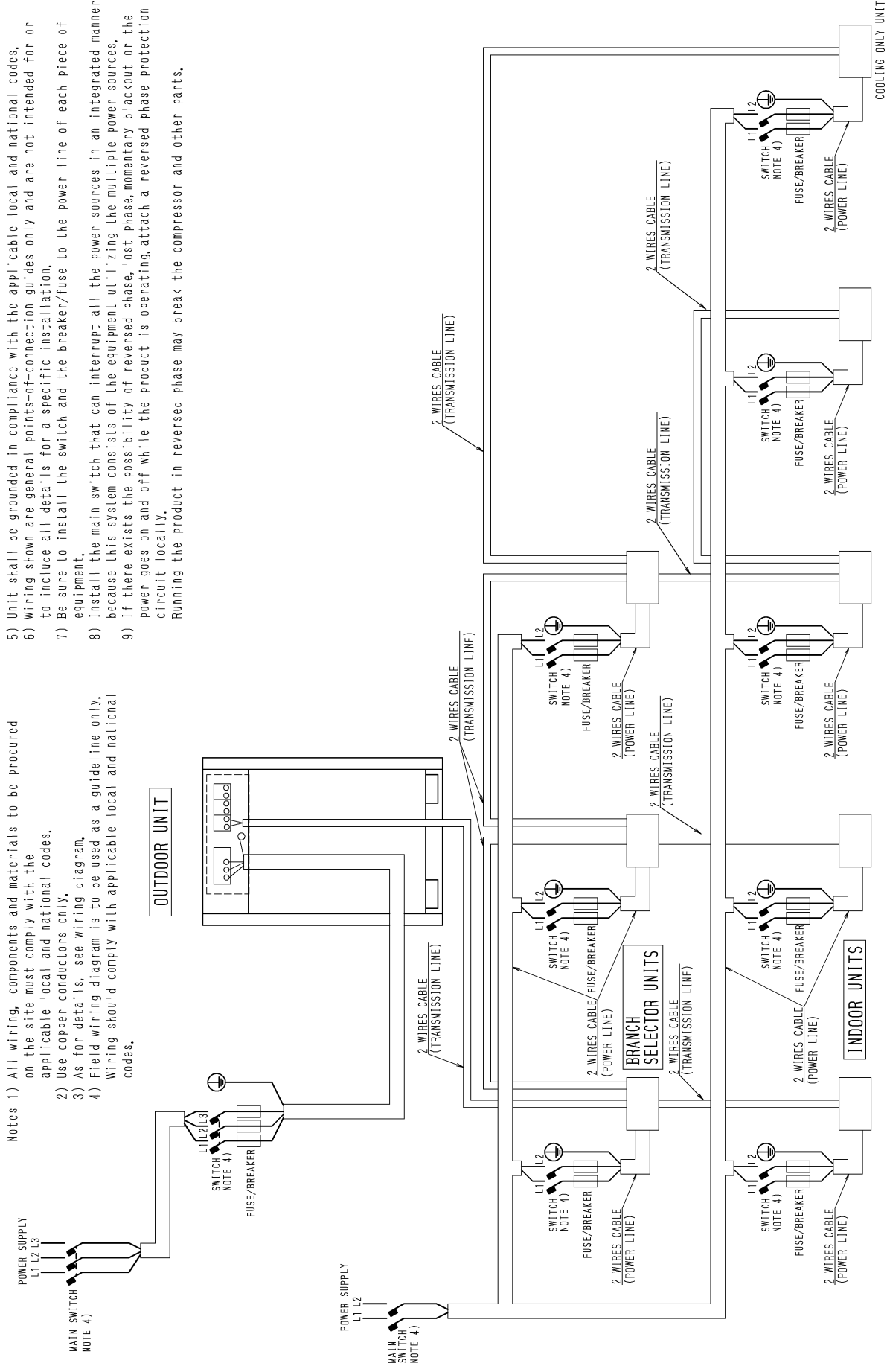

- Notes 1) All wiring, components and materials to be procured on the site must comply with the applicable local and national codes.
 - 2) Use copper conductors only.
 - 3) As for details, see wiring diagram.
 - 4) Field wiring diagram is to be used as a guideline only. Wiring should comply with applicable local and national codes.
- 5) Unit shall be grounded in compliance with the applicable local and national codes.
 - 6) Wiring shown are general points-of-connection guides only and are not intended for or to include all details for a specific installation.
 - 7) Be sure to install the switch and the breaker/fuse to the power line of each piece of equipment.
 - 8) Install the main switch that can interrupt all the power sources in an integrated manner because this system consists of the equipment utilizing the multiple power sources.
 - 9) If there exists the possibility of reversed phase, lost phase, momentary blackout or the power goes on and off while the product is operating, attach a reversed phase protection circuit locally.
- Running the product in reversed phase may break the compressor and other parts.

REYQ192 - 336XBTJA / XBYDA / XBYCA

- 5) Unit shall be grounded in compliance with the applicable local and national codes.
 - 6) Wiring shown are general points-of-connection guides only and are not intended for or to include all details for a specific installation.
 - 7) Be sure to install the switch and the breaker/fuse to the power line of each piece of equipment.
 - 8) Install the main switch that can interrupt all the power sources in an integrated manner because this system consists of the equipment utilizing the multiple power sources.
 - 9) If there exists the possibility of reversed phase, lost phase, momentary blackout or the power goes on and off while the product is operating, attach a reversed phase protection circuit locally.
- Running the product in reversed phase may break the compressor and other parts.

- Notes 1) All wiring, components and materials to be procured on the site must comply with the applicable local and national codes.
- 2) Use copper conductors only.
 - 3) As for details, see wiring diagram.
 - 4) Field wiring diagram is to be used as a guideline only.
- Wiring should comply with applicable local and national codes.

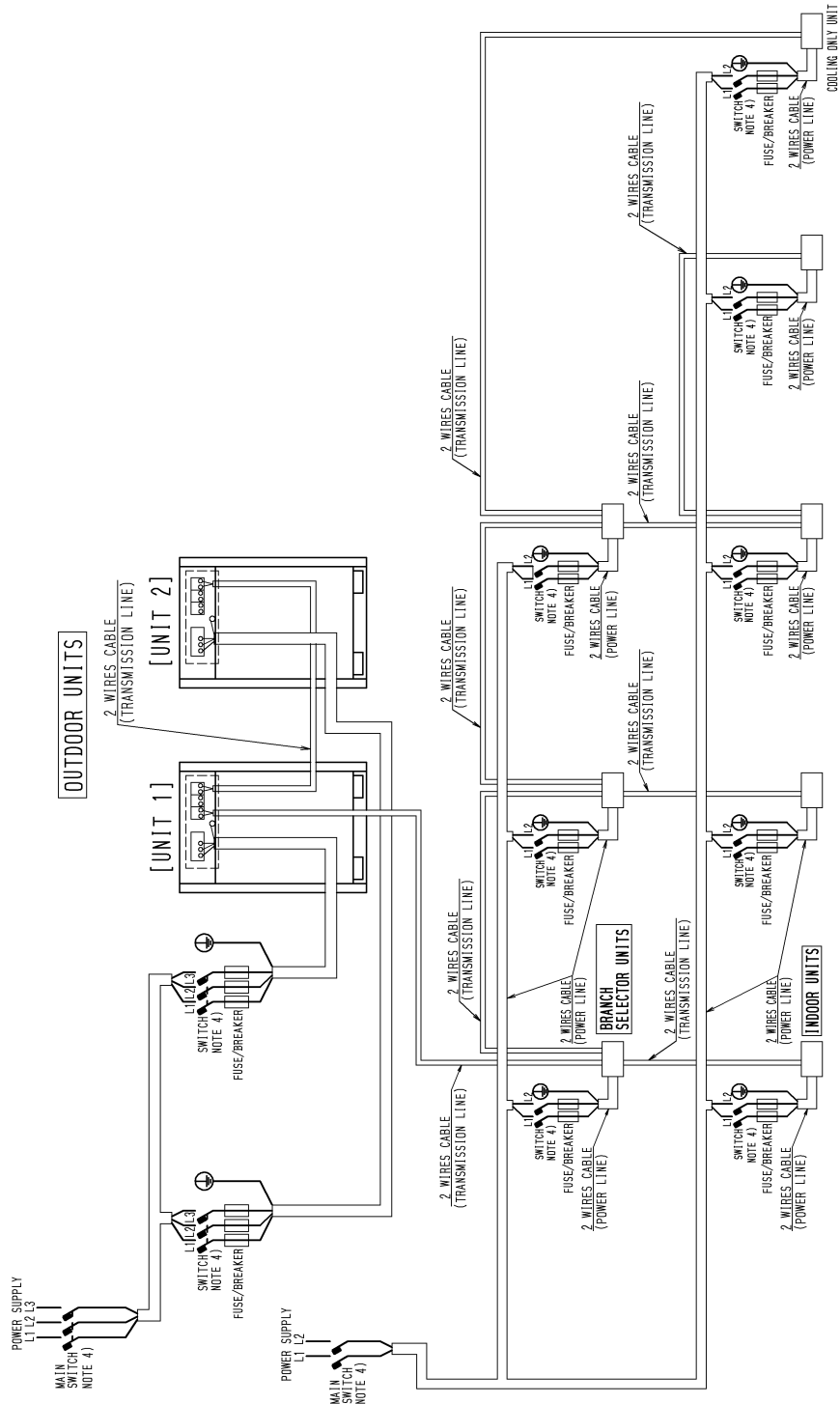

REYQ360 - 456XBTJA / XBYDA , REYQ360 - 432XBYCA

- Notes 1) All wiring, components and materials to be procured on the site must comply with the applicable local and national codes, 2) Use copper conductors only, 3) As for details, see wiring diagram, 4) Field wiring diagram is to be used as a guideline only. Wiring should comply with applicable local and national codes.
 - 5) Unit shall be grounded in compliance with the applicable local and national codes,
 - 6) Wiring shown are general points-of-connection guides only and are not intended for or to include all details for a specific installation,
 - 7) Be sure to install the switch and the breaker/fuse to the power line of each piece of equipment,
 - 8) Install the main switch that can interrupt all the power sources in an integrated manner because this system consists of the equipment utilizing the multiple power sources,
 - 9) If there exists the possibility of reversed phase, lost phase, momentary blackout or the power goes on and off while the product is operating, attach a reversed phase protection circuit locally.
- Running the product in reversed phase may break the compressor and other parts.

- Notes 1) All wiring, components and materials to be procured on the site must comply with the applicable local and national codes, 2) Use copper conductors only, 3) As for details, see wiring diagram, 4) Field wiring diagram is to be used as a guideline only. Wiring should comply with applicable local and national codes.

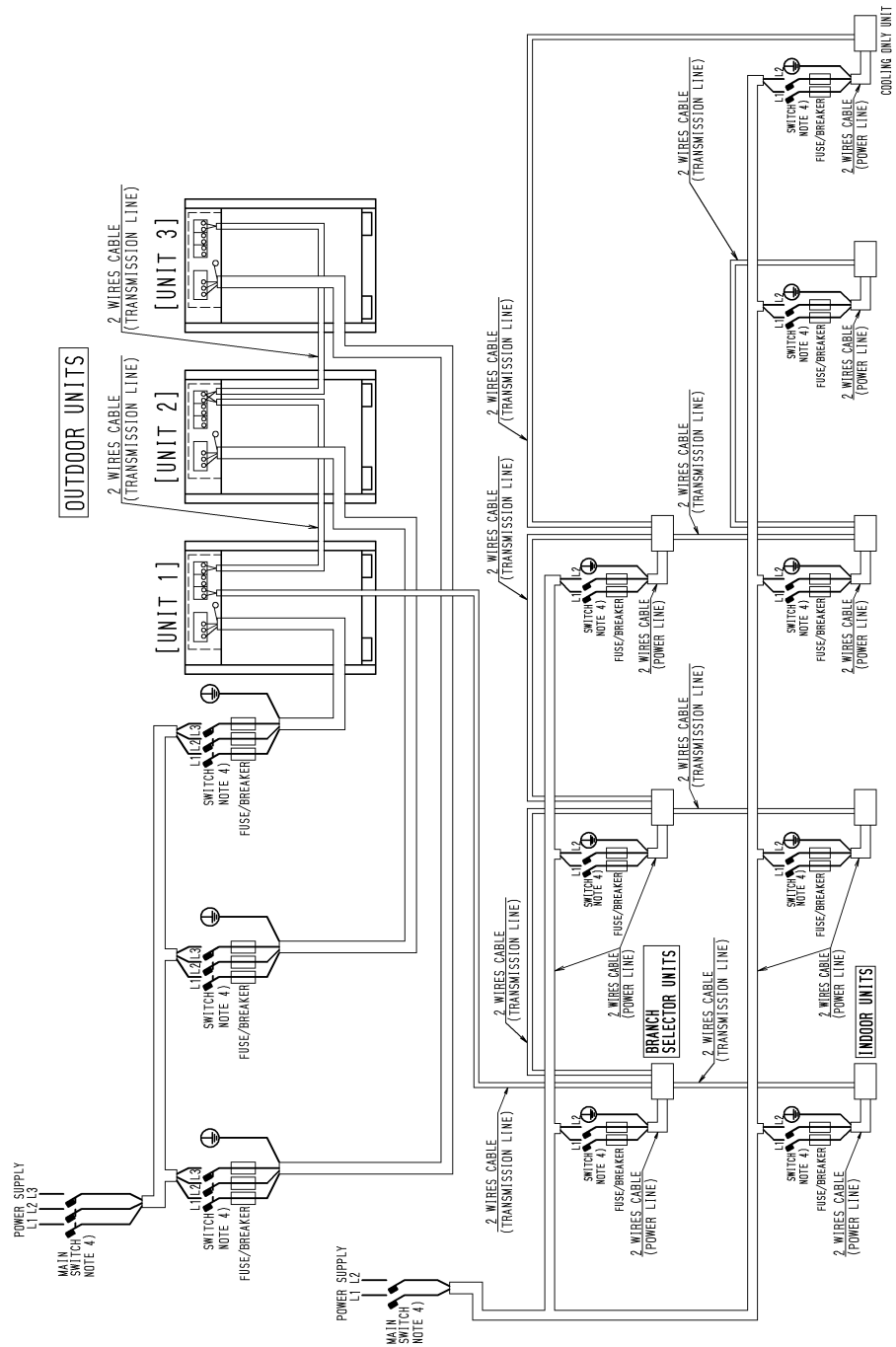

9. Electrical Characteristics

9.1 REYQ-XBTJA

REYQ72 - 168XBTJA

Model name	Units				Power supply		Comp.	OFM		SCCR
	Hz	Volts	Min.	Max.	MCA	MOP	RLA	kW	FLA	
REYQ72XBTJA	60	208 / 230	187	253	38.1	45	20.8	0.8 × 2	2.9 × 2	SCCR kA rms, Symmetrical @600 V MAX: 5
REYQ96XBTJA	60	208 / 230	187	253	38.1	45	23.3	0.8 × 2	2.9 × 2	
REYQ120XBTJA	60	208 / 230	187	253	43	50	28.2	0.8 × 2	2.9 × 2	
REYQ144XBTJA	60	208 / 230	187	253	58.3	70	42.6	0.8 × 2	2.9 × 2	
REYQ168XBTJA	60	208 / 230	187	253	61.9	70	49.0	0.8 × 2	2.9 × 2	

Symbols:

MCA: Min. Circuit Amps. (A)
 MOP: Max. Overcurrent Protector (A)
 RLA: Rated Load Amps. (A)
 OFM: Outdoor Fan Motor
 kW: Rated Motor Output (kW)
 FLA: Full Load Amps. (A)
 SCCR: Short-Circuit Current Rating

Notes:

- RLA is based on the following conditions.
 Indoor temp. 80°FDB (26.7°CDB) / 67°FWB (19.4°CWB)
 Outdoor temp. 95°FDB (35.0°CDB)
- Voltage range
 Units are designed to operate only at the rated voltage provided in the table above.
- The maximum percent unbalance of phase voltage shall be 2%.
- Select wire size based on the value of MCA.
- MOP is used to select the circuit breaker.

C: 4D120034

REYQ192 - 336XBTJA

Model name		Units				Power supply		Comp.	OFM	
Combination unit	Independent unit	Hz	Volts	Min.	Max.	MCA	MOP	RLA	kW	FLA
REYQ192XBTJA	REYQ96XBTJA	60	208 / 230	187	253	38.1 + 38.1	45 + 45	24.7 + 24.7	(0.8 × 2) × 2	(2.9 × 2) × 2
	REYQ96XBTJA									
REYQ216XBTJA	REYQ96XBTJA	60	208 / 230	187	253	38.1 + 43.0	45 + 50	28.5 + 28.5	(0.8 × 2) × 2	(2.9 × 2) × 2
	REYQ120XBTJA									
REYQ240XBTJA	REYQ120XBTJA	60	208 / 230	187	253	43.0 + 43.0	50 + 50	29.9 + 29.9	(0.8 × 2) × 2	(2.9 × 2) × 2
	REYQ120XBTJA									
REYQ264XBTJA	REYQ120XBTJA	60	208 / 230	187	253	43.0 + 58.3	50 + 70	32.9 + 42.1	(0.8 × 2) × 2	(2.9 × 2) × 2
	REYQ144XBTJA									
REYQ288XBTJA	REYQ144XBTJA	60	208 / 230	187	253	58.3 + 58.3	70 + 70	43.5 + 43.5	(0.8 × 2) × 2	(2.9 × 2) × 2
	REYQ144XBTJA									
REYQ312XBTJA	REYQ144XBTJA	60	208 / 230	187	253	58.3 + 61.9	70 + 70	46.5 + 46.5	(0.8 × 2) × 2	(2.9 × 2) × 2
	REYQ168XBTJA									
REYQ336XBTJA	REYQ168XBTJA	60	208 / 230	187	253	61.9 + 61.9	70 + 70	50.1 + 50.1	(0.8 × 2) × 2	(2.9 × 2) × 2
	REYQ168XBTJA									

Symbols:

MCA: Min. Circuit Amps. (A)
 MOP: Max. Overcurrent Protector (A)
 RLA: Rated Load Amps. (A)
 OFM: Outdoor Fan Motor
 kW: Rated Motor Output (kW)
 FLA: Full Load Amps. (A)

Notes:

1. RLA is based on the following conditions.
 Indoor temp. 80°FDB (26.7°CDB) / 67°FWB (19.4°CWB)
 Outdoor temp. 95°FDB (35.0°CDB)
2. Voltage range
 Units are designed to operate only at the rated voltage provided in the table above.
3. The maximum percent unbalance of phase voltage shall be 2%.
4. Select wire size based on the value of MCA.
5. MOP is used to select the circuit breaker.
6. Refer to electrical characteristics of each independent unit for SCCR.

C: 4D120035A

REYQ360 - 456XBTJA

Model name		Units				Power supply		Comp.	OFM	
Combination unit	Independent unit	Hz	Volts	Min.	Max.	MCA	MOP	RLA	kW	FLA
REYQ360XBTJA	REYQ120XBTJA	60	208 / 230	187	253	43.0 + 43.0 + 43.0	50 + 50 + 50	32.7 + 32.7 + 32.7	(0.8 × 2) × 3	(2.9 × 2) × 3
	REYQ120XBTJA									
	REYQ120XBTJA									
REYQ384XBTJA	REYQ120XBTJA	60	208 / 230	187	253	43.0 + 43.0 + 58.3	50 + 50 + 70	33.8 + 33.8 + 43.7	(0.8 × 2) × 3	(2.9 × 2) × 3
	REYQ120XBTJA									
	REYQ144XBTJA									
REYQ408XBTJA	REYQ120XBTJA	60	208 / 230	187	253	43.0 + 58.3 + 58.3	50 + 70 + 70	35.7 + 45.1 + 45.1	(0.8 × 2) × 3	(2.9 × 2) × 3
	REYQ144XBTJA									
	REYQ144XBTJA									
REYQ432XBTJA	REYQ144XBTJA	60	208 / 230	187	253	58.3 + 58.3 + 58.3	70 + 70 + 70	45.1 + 45.1 + 45.1	(0.8 × 2) × 3	(2.9 × 2) × 3
	REYQ144XBTJA									
	REYQ144XBTJA									
REYQ456XBTJA	REYQ144XBTJA	60	208 / 230	187	253	58.3 + 58.3 + 61.9	70 + 70 + 70	47.0 + 47.0 + 47.0	(0.8 × 2) × 3	(2.9 × 2) × 3
	REYQ144XBTJA									
	REYQ168XBTJA									

Symbols:

MCA: Min. Circuit Amps. (A)
MOP: Max. Overcurrent Protector (A)
RLA: Rated Load Amps. (A)
OFM: Outdoor Fan Motor
kW: Rated Motor Output (kW)
FLA: Full Load Amps. (A)

Notes:

- RLA is based on the following conditions.
Indoor temp. 80°FDB (26.7°CDB) / 67°FWB (19.4°CWB)
Outdoor temp. 95°FDB (35.0°CDB)
- Voltage range
Units are designed to operate only at the rated voltage provided in the table above.
- The maximum percent unbalance of phase voltage shall be 2%.
- Select wire size based on the value of MCA.
- MOP is used to select the circuit breaker.
- Refer to electrical characteristics of each independent unit for SCCR.

C: 4D120036A

9.2 REYQ-XBYDA

REYQ72 - 168XBYDA

Model name	Units				Power supply		Comp.	OFM		SCCR
	Hz	Volts	Min.	Max.	MCA	MOP	RLA	kW	FLA	
REYQ72XBYDA	60	460	416	508	18.9	25	9.4	0.6 × 2	1.0 × 2	SCCR kA rms, Symmetrical @600 V MAX: 5
REYQ96XBYDA	60	460	416	508	21.1	25	10.5	0.6 × 2	1.0 × 2	
REYQ120XBYDA	60	460	416	508	21.1	25	12.8	0.6 × 2	1.0 × 2	
REYQ144XBYDA	60	460	416	508	27.9	40	19.3	0.6 × 2	1.0 × 2	
REYQ168XBYDA	60	460	416	508	31.1	40	22.2	0.6 × 2	1.0 × 2	

Symbols:

MCA: Min. Circuit Amps. (A)
 MOP: Max. Overcurrent Protector (A)
 RLA: Rated Load Amps. (A)
 OFM: Outdoor Fan Motor
 kW: Rated Motor Output (kW)
 FLA: Full Load Amps. (A)
 SCCR: Short-Circuit Current Rating

Notes:

- RLA is based on the following conditions.
 Indoor temp. 80°FDB (26.7°CDB) / 67°FWB (19.4°CWB)
 Outdoor temp. 95°FDB (35.0°CDB)
- Voltage range
 Units are designed to operate only at the rated voltage provided in the table above.
- The maximum percent unbalance of phase voltage shall be 2%.
- Select wire size based on the value of MCA.
- MOP is used to select the circuit breaker.

C: 4D120038

REYQ192 - 336XBYDA

Model name		Units				Power supply		Comp.	OFM	
Combination unit	Independent unit	Hz	Volts	Min.	Max.	MCA	MOP	RLA	kW	FLA
REYQ192XBYDA	REYQ96XBYDA	60	460	416	508	21.1 + 21.1	25 + 25	11.2 + 11.2	(0.6 × 2) × 2	(1.0 × 2) × 2
	REYQ96XBYDA									
REYQ216XBYDA	REYQ96XBYDA	60	460	416	508	21.1 + 21.1	25 + 25	12.9 + 12.9	(0.6 × 2) × 2	(1.0 × 2) × 2
	REYQ120XBYDA									
REYQ240XBYDA	REYQ120XBYDA	60	460	416	508	21.1 + 21.1	25 + 25	13.5 + 13.5	(0.6 × 2) × 2	(1.0 × 2) × 2
	REYQ120XBYDA									
REYQ264XBYDA	REYQ120XBYDA	60	460	416	508	21.1 + 27.9	25 + 40	14.9 + 19	(0.6 × 2) × 2	(1.0 × 2) × 2
	REYQ144XBYDA									
REYQ288XBYDA	REYQ144XBYDA	60	460	416	508	27.9 + 27.9	40 + 40	19.7 + 19.7	(0.6 × 2) × 2	(1.0 × 2) × 2
	REYQ144XBYDA									
REYQ312XBYDA	REYQ144XBYDA	60	460	416	508	27.9 + 31.1	40 + 40	21 + 21	(0.6 × 2) × 2	(1.0 × 2) × 2
	REYQ168XBYDA									
REYQ336XBYDA	REYQ168XBYDA	60	460	416	508	31.1 + 31.1	40 + 40	22.7 + 22.7	(0.6 × 2) × 2	(1.0 × 2) × 2
	REYQ168XBYDA									

Symbols:

MCA: Min. Circuit Amps. (A)
 MOP: Max. Overcurrent Protector (A)
 RLA: Rated Load Amps. (A)
 OFM: Outdoor Fan Motor
 kW: Rated Motor Output (kW)
 FLA: Full Load Amps. (A)

Notes:

1. RLA is based on the following conditions.
 Indoor temp. 80°FDB (26.7°CDB) / 67°FWB (19.4°CWB)
 Outdoor temp. 95°FDB (35.0°CDB)
2. Voltage range
 Units are designed to operate only at the rated voltage provided in the table above.
3. The maximum percent unbalance of phase voltage shall be 2%.
4. Select wire size based on the value of MCA.
5. MOP is used to select the circuit breaker.
6. Refer to electrical characteristics of each independent unit for SCCR.

C: 4D120039A

REYQ360 - 456XBYDA

Model name		Units				Power supply		Comp.	OFM	
Combination unit	Independent unit	Hz	Volts	Min.	Max.	MCA	MOP	RLA	kW	FLA
REYQ360XBYDA	REYQ120XBYDA	60	460	416	508	21.1 + 21.1 + 21.1	25 + 25 + 25	14.8 + 14.8 + 14.8	(0.6 × 2) × 3	(1.0 × 2) × 3
	REYQ120XBYDA									
	REYQ120XBYDA									
REYQ384XBYDA	REYQ120XBYDA	60	460	416	508	21.1 + 21.1 + 27.9	25 + 25 + 40	15.3 + 15.3 + 19.8	(0.6 × 2) × 3	(1.0 × 2) × 3
	REYQ120XBYDA									
	REYQ144XBYDA									
REYQ408XBYDA	REYQ120XBYDA	60	460	416	508	21.1 + 27.9 + 27.9	25 + 40 + 40	16.2 + 20.4 + 20.4	(0.6 × 2) × 3	(1.0 × 2) × 3
	REYQ144XBYDA									
	REYQ144XBYDA									
REYQ432XBYDA	REYQ144XBYDA	60	460	416	508	27.9 + 27.9 + 27.9	40 + 40 + 40	20.4 + 20.4 + 20.4	(0.6 × 2) × 3	(1.0 × 2) × 3
	REYQ144XBYDA									
	REYQ144XBYDA									
REYQ456XBYDA	REYQ144XBYDA	60	460	416	508	27.9 + 27.9 + 31.1	40 + 40 + 40	21.3 + 21.3 + 21.3	(0.6 × 2) × 3	(1.0 × 2) × 3
	REYQ144XBYDA									
	REYQ168XBYDA									

Symbols:

MCA: Min. Circuit Amps. (A)
 MOP: Max. Overcurrent Protector (A)
 RLA: Rated Load Amps. (A)
 OFM: Outdoor Fan Motor
 kW: Rated Motor Output (kW)
 FLA: Full Load Amps. (A)

Notes:

- RLA is based on the following conditions.
 Indoor temp. 80°FDB (26.7°CDB) / 67°FWB (19.4°CWB)
 Outdoor temp. 95°FDB (35.0°CDB)
- Voltage range
 Units are designed to operate only at the rated voltage provided in the table above.
- The maximum percent unbalance of phase voltage shall be 2%.
- Select wire size based on the value of MCA.
- MOP is used to select the circuit breaker.
- Refer to electrical characteristics of each independent unit for SCCR.

C: 4D120040A

9.3 REYQ-XBYCA

REYQ72 - 168XBYCA

Model name	Units				Power supply		Comp.	OFM		SCCR
	Hz	Volts	Min.	Max.	MCA	MOP	RLA	kW	FLA	
REYQ72XBYCA	60	575	518	632	15.1	20	7.5	0.7 × 2	1.0 × 2	SCCR kA rms, Symmetrical @600 V MAX: 5
REYQ96XBYCA	60	575	518	632	16.8	20	8.4	0.7 × 2	1.0 × 2	
REYQ120XBYCA	60	575	518	632	18.2	25	10.2	0.7 × 2	1.0 × 2	
REYQ144XBYCA	60	575	518	632	22.3	30	15.4	0.7 × 2	1.0 × 2	
REYQ168XBYCA	60	575	518	632	24.9	30	17.7	0.7 × 2	1.0 × 2	

Symbols:

MCA: Min. Circuit Amps. (A)
 MOP: Max. Overcurrent Protector (A)
 RLA: Rated Load Amps. (A)
 OFM: Outdoor Fan Motor
 kW: Rated Motor Output (kW)
 FLA: Full Load Amps. (A)
 SCCR: Short-Circuit Current Rating

Notes:

- RLA is based on the following conditions.
 Indoor temp. 80°FDB (26.7°CDB) / 67°FWB (19.4°CWB)
 Outdoor temp. 95°FDB (35.0°CDB)
- Voltage range
 Units are designed to operate only at the rated voltage provided in the table above.
- The maximum percent unbalance of phase voltage shall be 2%.
- Select wire size based on the value of MCA.
- MOP is used to select the circuit breaker.

C: 4D120041

REYQ192 - 336XBYCA

Model name		Units				Power supply		Comp.	OFM	
Combination unit	Independent unit	Hz	Volts	Min.	Max.	MCA	MOP	RLA	kW	FLA
REYQ192XBYCA	REYQ96XBYCA	60	575	518	632	16.8 + 16.8	20 + 20	8.9 + 8.9	(0.7 × 2) × 2	(1.0 × 2) × 2
	REYQ96XBYCA									
REYQ216XBYCA	REYQ96XBYCA	60	575	518	632	16.8 + 18.2	20 + 25	10.3 + 10.3	(0.7 × 2) × 2	(1.0 × 2) × 2
	REYQ120XBYCA									
REYQ240XBYCA	REYQ120XBYCA	60	575	518	632	18.2 + 18.2	25 + 25	10.8 + 10.8	(0.7 × 2) × 2	(1.0 × 2) × 2
	REYQ120XBYCA									
REYQ264XBYCA	REYQ120XBYCA	60	575	518	632	18.2 + 22.3	25 + 30	11.9 + 15.2	(0.7 × 2) × 2	(1.0 × 2) × 2
	REYQ144XBYCA									
REYQ288XBYCA	REYQ144XBYCA	60	575	518	632	22.3 + 22.3	30 + 30	15.7 + 15.7	(0.7 × 2) × 2	(1.0 × 2) × 2
	REYQ144XBYCA									
REYQ312XBYCA	REYQ144XBYCA	60	575	518	632	22.3 + 24.9	30 + 30	16.8 + 16.8	(0.7 × 2) × 2	(1.0 × 2) × 2
	REYQ168XBYCA									
REYQ336XBYCA	REYQ168XBYCA	60	575	518	632	24.9 + 24.9	30 + 30	18.1 + 18.1	(0.7 × 2) × 2	(1.0 × 2) × 2
	REYQ168XBYCA									

Symbols:

MCA: Min. Circuit Amps. (A)
MOP: Max. Overcurrent Protector (A)
RLA: Rated Load Amps. (A)
OFM: Outdoor Fan Motor
kW: Rated Motor Output (kW)
FLA: Full Load Amps. (A)

Notes:

1. RLA is based on the following conditions.
Indoor temp. 80°FDB (26.7°CDB) / 67°FWB (19.4°CWB)
Outdoor temp. 95°FDB (35.0°CDB)
2. Voltage range
Units are designed to operate only at the rated voltage provided in the table above.
3. The maximum percent unbalance of phase voltage shall be 2%.
4. Select wire size based on the value of MCA.
5. MOP is used to select the circuit breaker.
6. Refer to electrical characteristics of each independent unit for SCCR.

C: 4D120042A

REYQ360 - 432XBYCA

Model name		Units				Power supply		Comp.	OFM	
Combination unit	Independent unit	Hz	Volts	Min.	Max.	MCA	MOP	RLA	kW	FLA
REYQ360XBYCA	REYQ120XBYCA	60	575	518	632	18.2 + 18.2 + 18.2	25 + 25 + 25	11.8 + 11.8 + 11.8	(0.7 × 2) × 3	(1.0 × 2) × 3
	REYQ120XBYCA									
	REYQ120XBYCA									
REYQ384XBYCA	REYQ120XBYCA	60	575	518	632	18.2 + 18.2 + 22.3	25 + 25 + 30	12.2 + 12.2 + 15.8	(0.7 × 2) × 3	(1.0 × 2) × 3
	REYQ120XBYCA									
	REYQ144XBYCA									
REYQ408XBYCA	REYQ120XBYCA	60	575	518	632	18.2 + 22.3 + 22.3	25 + 30 + 30	12.9 + 16.3 + 16.3	(0.7 × 2) × 3	(1.0 × 2) × 3
	REYQ144XBYCA									
	REYQ144XBYCA									
REYQ432XBYCA	REYQ144XBYCA	60	575	518	632	22.3 + 22.3 + 22.3	30 + 30 + 30	16.3 + 16.3 + 16.3	(0.7 × 2) × 3	(1.0 × 2) × 3
	REYQ144XBYCA									
	REYQ144XBYCA									

Symbols:

MCA: Min. Circuit Amps. (A)
 MOP: Max. Overcurrent Protector (A)
 RLA: Rated Load Amps. (A)
 OFM: Outdoor Fan Motor
 kW: Rated Motor Output (kW)
 FLA: Full Load Amps. (A)

Notes:

- RLA is based on the following conditions.
 Indoor temp. 80°FDB (26.7°CDB) / 67°FWB (19.4°CWB)
 Outdoor temp. 95°FDB (35.0°CDB)
- Voltage range
 Units are designed to operate only at the rated voltage provided in the table above.
- The maximum percent unbalance of phase voltage shall be 2%.
- Select wire size based on the value of MCA.
- MOP is used to select the circuit breaker.
- Refer to electrical characteristics of each independent unit for SCCR.

C: 4D120043A

10. Operation Limits

REYQ72 - 456XBTJA / XBYDA
 REYQ72 - 432XBYCA

Cooling

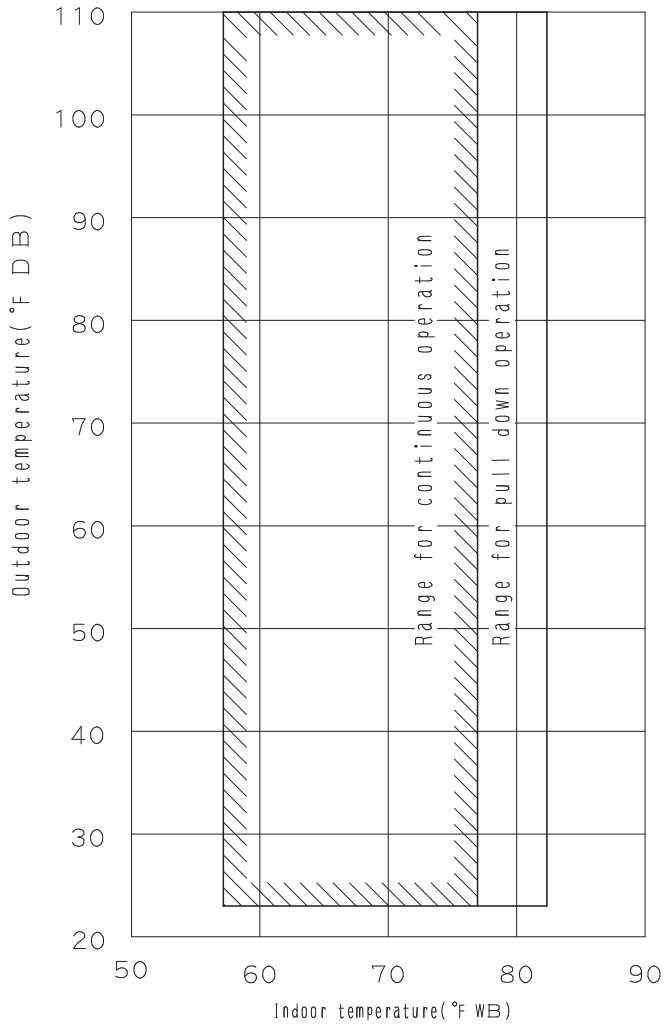

Heating

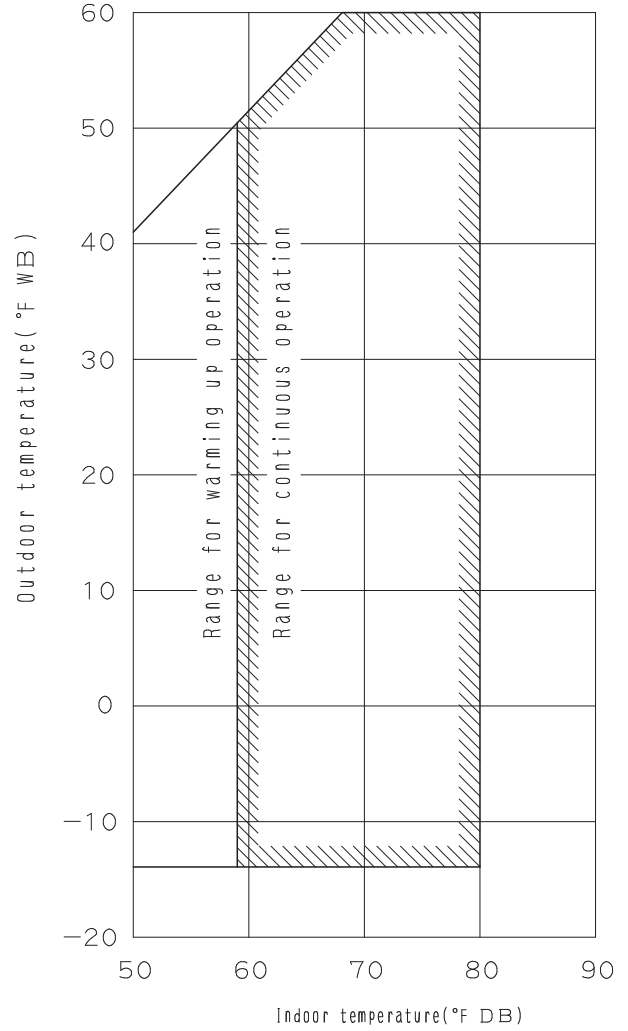

11. Low Ambient Cooling Enhancement

REYQ72 - 456XBTJA / XBYDA

REYQ72 - 432XBYCA

- REYQ-X series include a feature for Low Ambient Cooling.
- The function enhances REYQ-X series as follows:
 - Allows operation to -4°FDB (-20°CDB) ambient temperature in cooling mode. (Normal limit is 23°FDB (-5°CDB).)
 - Operation below 23°FDB (-5°CDB) requires the addition of wind covers onto the outdoor unit.*2

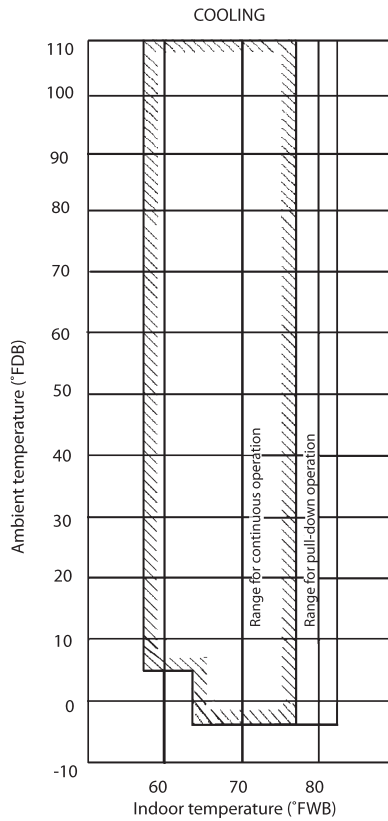

Application Rules:

- Total connection index of each system is limited to 50-130% when height difference is 0-194 ft. (0-50 m), 80-130% when 194-295 ft. (50-90 m).
- All units on the system must be connected to a Branch Selector Box. Low Ambient Cooling is available on indoor units connected to either single-port (BSQ_T) or Flex Series (BSF_Q54T) multi-port branch selector boxes *1. Both single port and multi port boxes can be used in the same system, however indoor units connected to Standard Series (BS_Q54T) multi port branch selector boxes will operate as standard without Low Ambient Cooling functionality.
- Function is engaged by a field setting on the outdoor unit to enable Low ambient cooling.*1 A dip switch setting is necessary on the Single Branch Selector Boxes BSQ-T series serving the indoor units NOT subject to Low Ambient Cooling requirements. For Flex series (BSF_Q54T) Multi-port Branch Selector Boxes, all indoor units connected to each port are subject to Low Ambient Cooling mode if the field setting on the outdoor unit is effective.
- During operation below 23°FDB (-5°CDB), the available cooling capacity decreases as follows:
 - 14°FDB (-10°CDB) - Reduces to 80% of nominal.
 - 5°FDB (-15°CDB) - Reduces to 65% of nominal.
 - 4°FDB (-20°CDB) - Reduces to 60% of nominal. *1
- While system is operating in low ambient cooling mode, Branch selector boxes supporting low ambient cooling could experience operation sound levels of up to 3 dB(A) higher than maximum. It is recommended to locate units away from zones sensitive to sound levels. *1
- The standard height difference limit is 164 ft. (50 m) when outdoor unit is above indoor unit (it can be extended to 295 ft. (90 m) for VRV IV-X) and 130 ft. (40 m) when outdoor unit is below indoor unit (it can be extended to 195 ft. (60 m) for VRV IV-X).
- If ambient temperature is less than the setting of Heat pump lockout temp, indoor units connected to the system cannot operate in cooling mode. In this case the system can operate only in heating mode via an auxiliary heat or secondary heat source. *3

Note:

- *1. Applicable for single branch selector unit (BSQ-T) and Flex branch selector unit (BSF-Q54T). (Standard multi port branch selector unit (BS-Q54T) is not applicable)
- *2. Contact your local Daikin representative for wind cover specification requirements and part numbers.
- *3. The heat pump lockout function is not activated by default. Refer to the installation or service manual for more details about this function.

12. Sound Levels (Reference Data)

REYQ72XBTJA / XBYDA / XBYCA

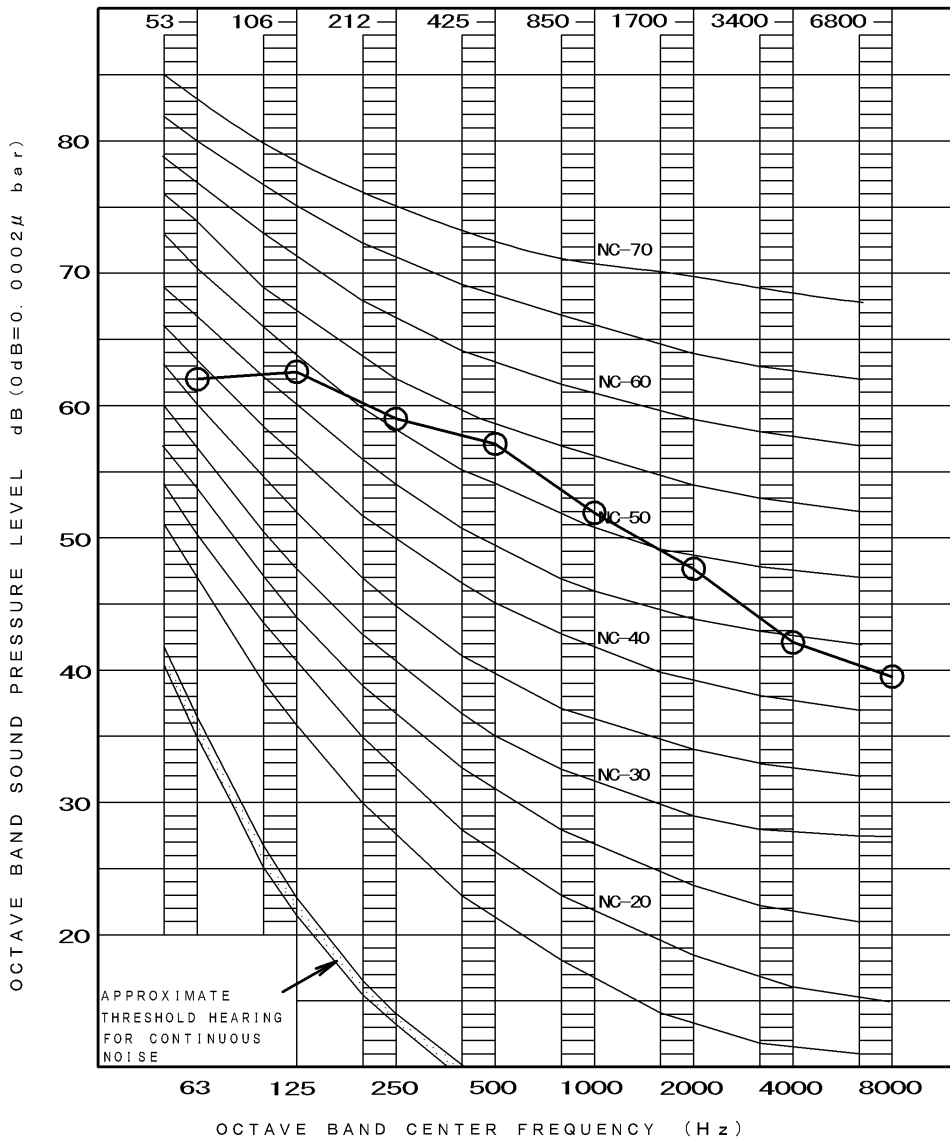

OVER ALL (dB)

SCALE	60Hz
A	58

(B. G. N IS ALREADY RECTIFIED)

OPERATING CONDITIONS

POWER SOURCE	208/230V	60Hz
	460V	60Hz
	575V	60Hz

MEASURING PLACE

ANECHOIC CHAMBER (CONVERSION VALUE)

LOCATION OF MICROPHONE

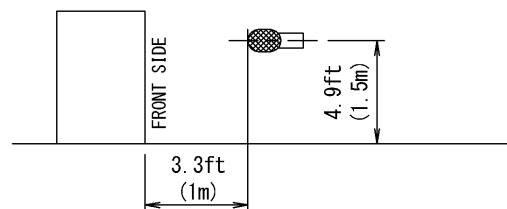

NOTE : THE OPERATING SOUND IS MEASURED IN ANECHOIC CHAMBER, IF IT IS MEASURED UNDER THE ACTUAL INSTALLATION CONDITIONS, IT IS NORMALLY OVER THE SET VALUE DUE TO ENVIRONMENTAL NOISE AND SOUND REFLECTION.

REYQ96XBTJA / XBYDA / XBYCA

3. Specification

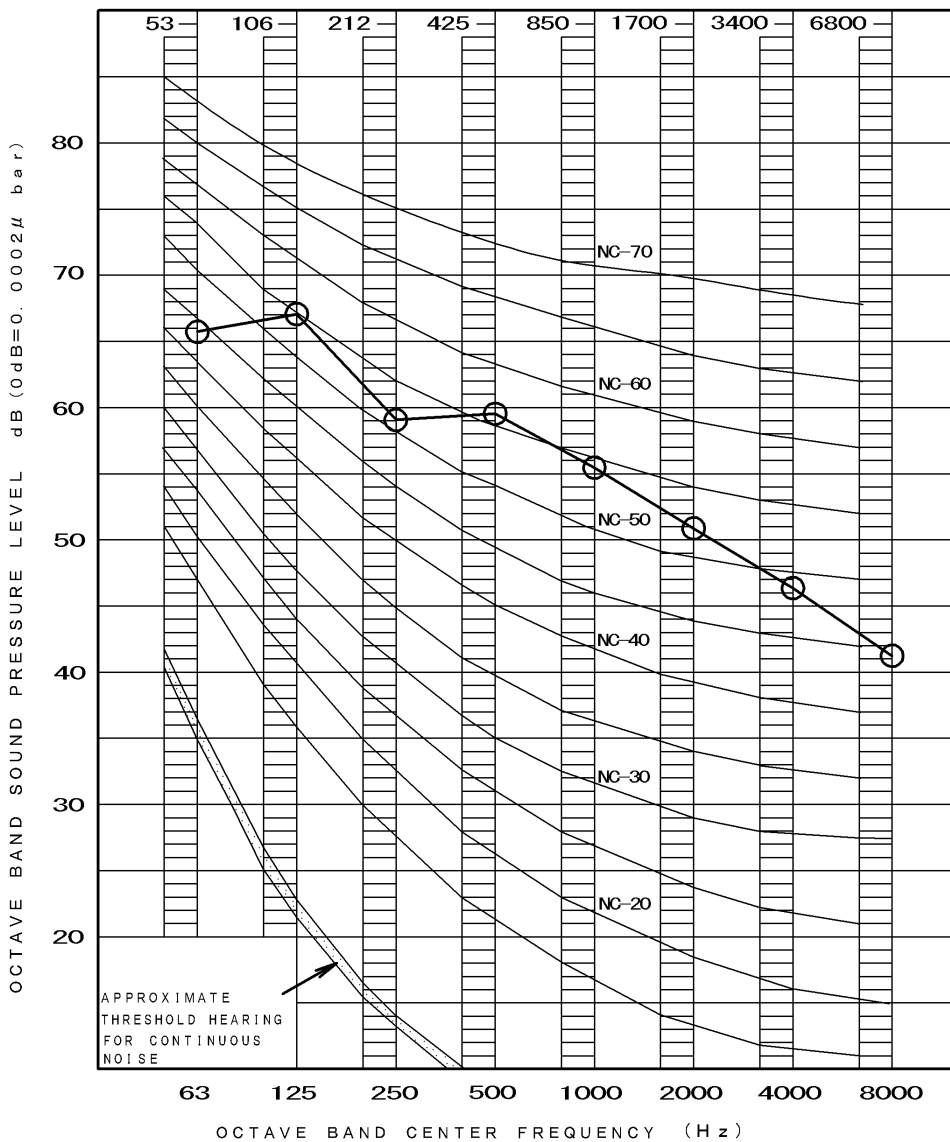

OVER ALL (dB)

SCALE	60Hz
A	61

(B. G. N IS ALREADY RECTIFIED)

OPERATING CONDITIONS

POWER SOURCE	208/230V	60Hz
	460V	60Hz
	575V	60Hz

MEASURING PLACE

ANECHOIC CHAMBER (CONVERSION VALUE)

LOCATION OF MICROPHONE

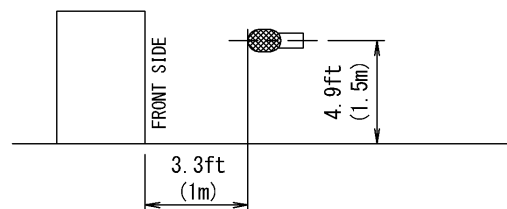

NOTE : THE OPERATING SOUND IS MEASURED IN ANECHOIC CHAMBER, IF IT IS MEASURED UNDER THE ACTUAL INSTALLATION CONDITIONS, IT IS NORMALLY OVER THE SET VALUE DUE TO ENVIRONMENTAL NOISE AND SOUND REFLECTION.

REYQ120XBTJA / XBYDA / XBYCA

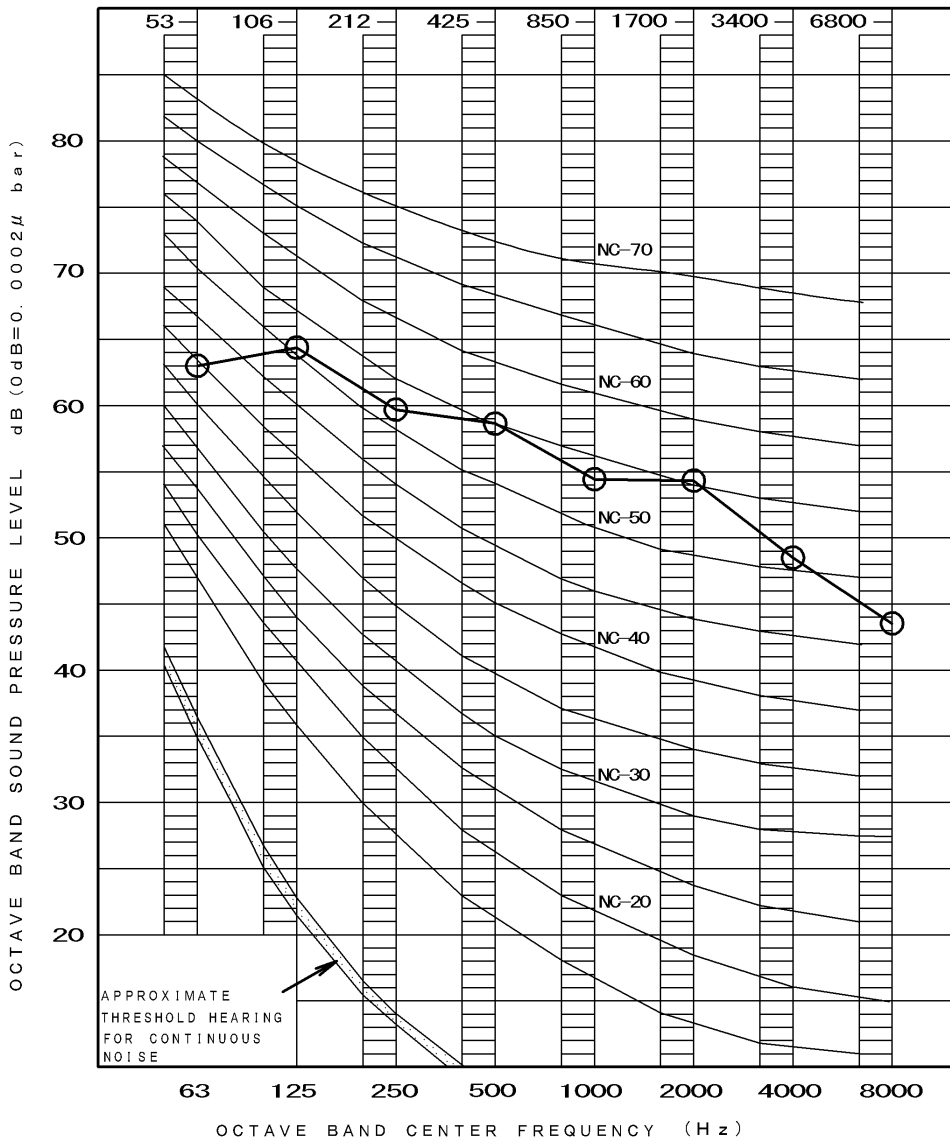

OVER ALL (dB)

SCALE	60Hz
A	61

(B. G. N IS ALREADY RECTIFIED)

OPERATING CONDITIONS

POWER SOURCE	208/230V	60Hz
	460V	60Hz
	575V	60Hz

MEASURING PLACE

ANECHOIC CHAMBER (CONVERSION VALUE)

LOCATION OF MICROPHONE

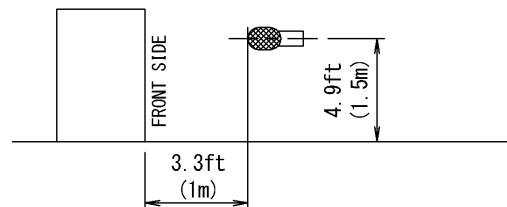

NOTE : THE OPERATING SOUND IS MEASURED IN ANECHOIC CHAMBER, IF IT IS MEASURED UNDER THE ACTUAL INSTALLATION CONDITIONS, IT IS NORMALLY OVER THE SET VALUE DUE TO ENVIRONMENTAL NOISE AND SOUND REFLECTION.

REYQ144XBTJA / XBYDA / XBYCA

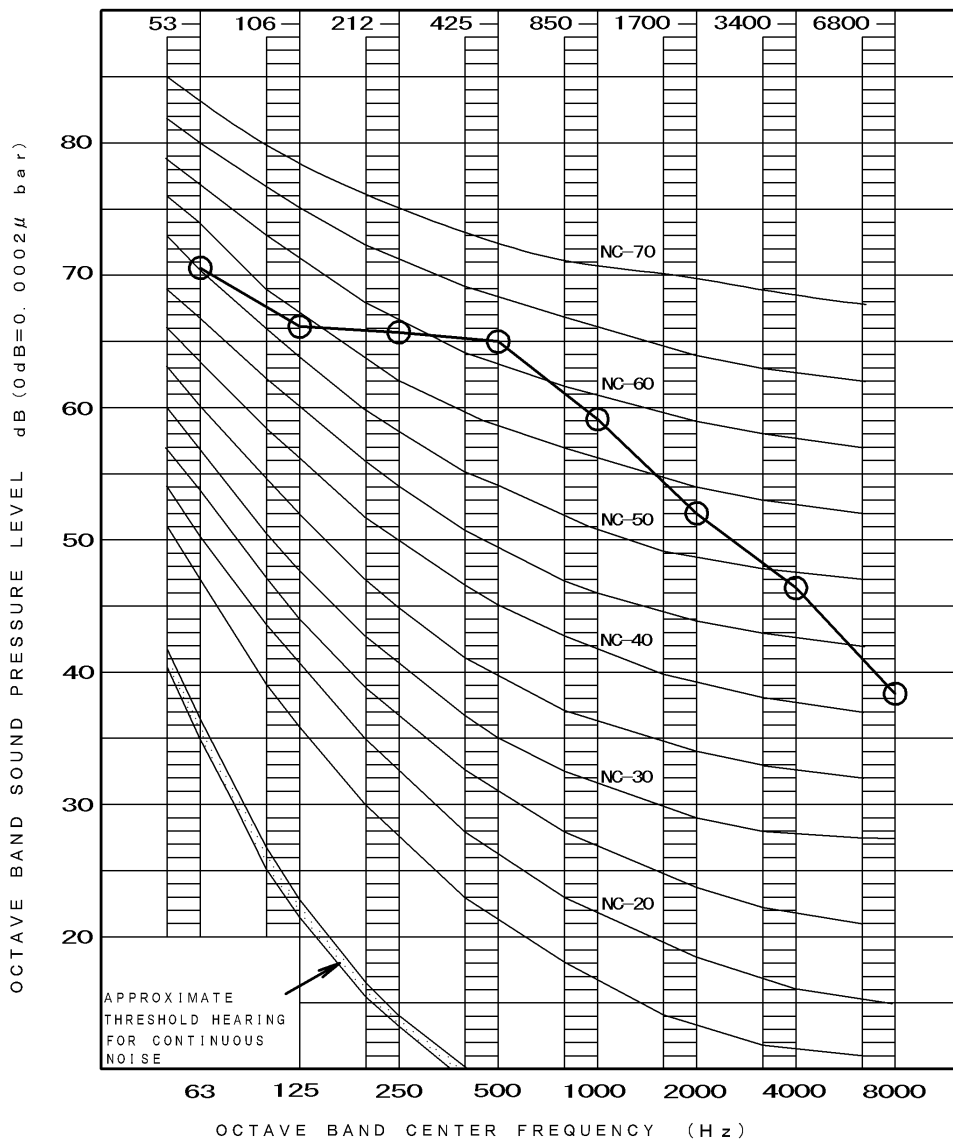

OVER ALL (dB)

SCALE	60Hz
A	65

(B. G. N IS ALREADY RECTIFIED)

OPERATING CONDITIONS

POWER SOURCE	208/230V	60Hz
	460V	60Hz
	575V	60Hz

MEASURING PLACE

ANECHOIC CHAMBER (CONVERSION VALUE)

LOCATION OF MICROPHONE

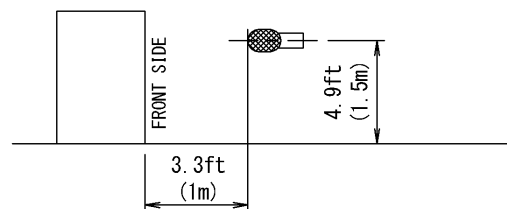

NOTE : THE OPERATING SOUND IS MEASURED IN ANECHOIC CHAMBER, IF IT IS MEASURED UNDER THE ACTUAL INSTALLATION CONDITIONS, IT IS NORMALLY OVER THE SET VALUE DUE TO ENVIRONMENTAL NOISE AND SOUND REFLECTION.

REYQ168XBTJA / XBYDA / XBYCA

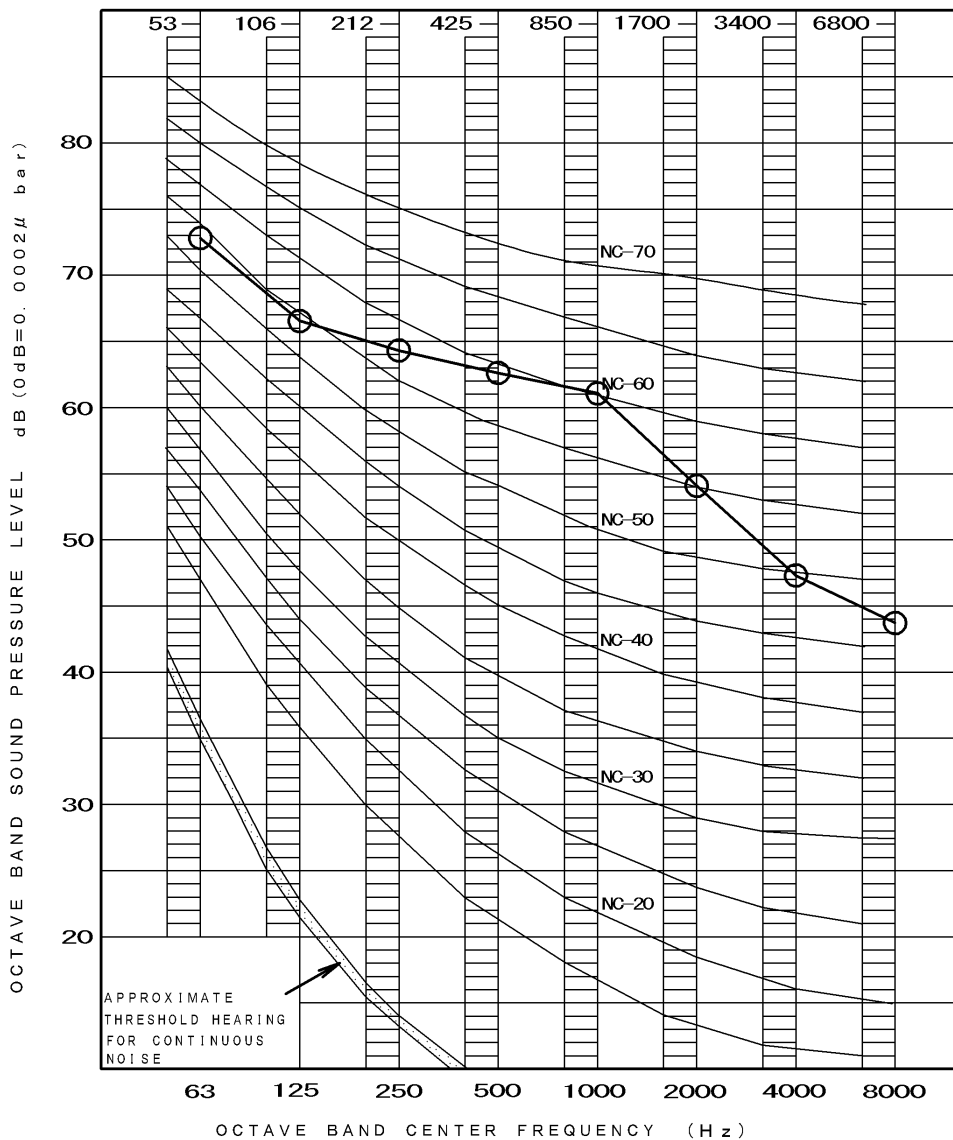

OVER ALL (dB)

SCALE	60Hz
A	65

(B. G. N IS ALREADY RECTIFIED)

OPERATING CONDITIONS

POWER SOURCE	208/230V	60Hz
	460V	60Hz
	575V	60Hz

MEASURING PLACE

ANECHOIC CHAMBER (CONVERSION VALUE)

LOCATION OF MICROPHONE

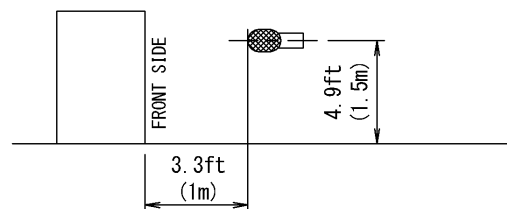

NOTE : THE OPERATING SOUND IS MEASURED IN ANECHOIC CHAMBER, IF IT IS MEASURED UNDER THE ACTUAL INSTALLATION CONDITIONS, IT IS NORMALLY OVER THE SET VALUE DUE TO ENVIRONMENTAL NOISE AND SOUND REFLECTION.

13. Accessories

13.1 Optional Accessories

REYQ72 - 456XBTJA / XBYDA

REYQ72 - 432XBYCA

Optional accessories		REYQ72-96XBTJA REYQ72-96XBYDA REYQ72-96XBYCA	REYQ120-168XBTJA REYQ120-168XBYDA REYQ120-168XBYCA	REYQ192-336XBTJA REYQ192-336XBYDA REYQ192-336XBYCA	REYQ360-456XBTJA REYQ360-456XBYDA REYQ360-432XBYCA
Distributive piping	REFNET header	KHRP25M33H9, KHRP25M33HA (Max.8 branch)	KHRP25M33H9, KHRP25M33HA (Max.8 branch) KHRP25M72H9, KHRP25M72HA (Max.8 branch)	KHRP25M33H9, KHRP25M33HA (Max.8 branch) KHRP25M72H9, KHRP25M72HA (Max.8 branch) KHRP25M73HU9, KHRP25M73HUA (Max.8 branch)	
	REFNET joint	KHRP25A22T9, KHRP25A22TA KHRP25A33T9, KHRP25A33TA	KHRP25A22T9, KHRP25A22TA KHRP25A33T9, KHRP25A33TA KHRP25M72TU9, KHRP25M72TUA	KHRP25A22T9, KHRP25A22TA KHRP25A33T9, KHRP25A33TA KHRP25M72TU9, KHRP25M72TUA	
Outdoor unit multi connection piping kit		—	—	BHFP26P100U, BHFP26P100UA	BHFP26P151U, BHFP26P151UA

C: 3D091328H

14. Selection Procedure

14.1 Selection Procedure

Flowchart

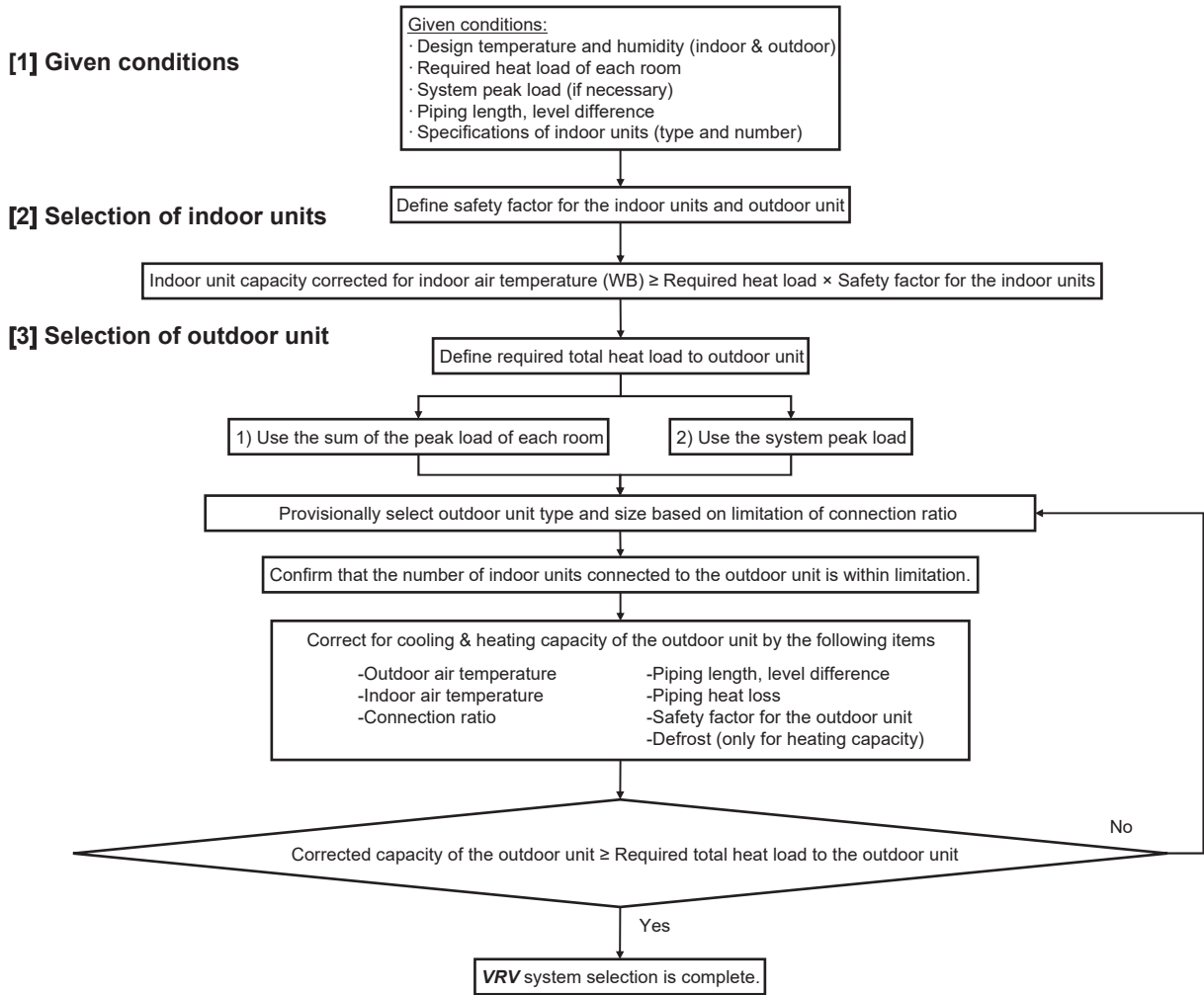

Selection Example

The following is a selection example based on total heat load for cooling.

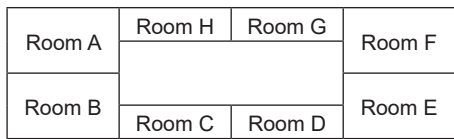

Floor plan

[1] Given conditions

-Design conditions

Indoor air temperature: 67°F WB / 80°F DB, Outdoor air temperature: 93°F DB

-Determine peak load of each room (and system peak load if necessary)

-Required heat load of each room

Time	Room A	Room B	Room C	Room D	Room E	Room F	Room G	Room H	Total
9:00	16.4	16.5	10.4	10.4	30.9	30.8	10.0	10.0	135.4
12:00	22.4	24.4	17.3	17.3	25.1	23.2	13.7	13.7	157.1
14:00	30.7	32.2	16.8	16.8	24.9	23.4	14.1	14.1	173.0
16:00	36.1	36.4	13.3	13.3	21.5	21.2	13.0	13.0	167.8

Total heat load (MBH)

From the above heat load calculation, the maximum heat load for the system (system peak load) is 173.0 MBH.

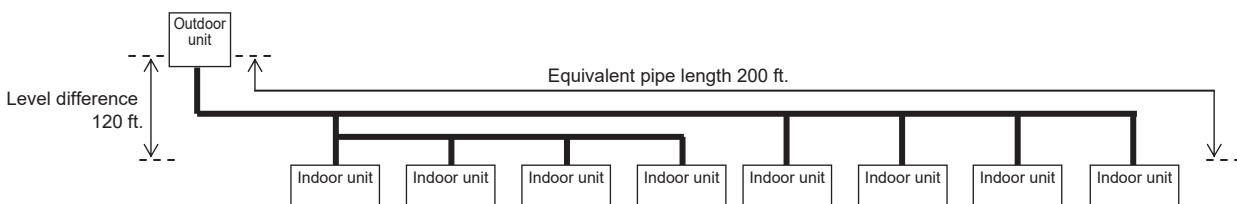

Select **VRV** indoor units FXMQ-TB series for each room.

-Safety factor

In this example, safety factor is not used. (i. e., safety factor = 1.0)

[2] Selection of indoor units

Calculate total heat capacity of indoor units corrected for indoor air temperature.

In case design temperature of the indoor air falls between temperatures listed in the table, calculate the capacity by interpolation.

The corrected total heat capacity of indoor units shall satisfy the maximum heat load of each room.

Capacity table of indoor unit
Cooling Capacity

Model	Indoor air temp. °FWB (°CWB) (Te: 43°F (6°C))											
	61 (16.1)		64 (17.8)		67 (19.4)		70 (21.1)		72 (22.2)		75 (23.9)	
	TC	SHC	TC	SHC	TC	SHC	TC	SHC	TC	SHC	TC	SHC
	MBH	MBH	MBH	MBH	MBH	MBH	MBH	MBH	MBH	MBH	MBH	MBH
FXMQ15TBVJU	11.4	9.3	12.9	10.2	14.2	10.4	14.5	10.1	14.6	10.0	14.8	9.5
FXMQ18TBVJU	14.5	12.3	16.3	13.5	18.0	13.8	18.4	13.5	18.7	13.3	18.8	13.0
FXMQ24TBVJU	19.3	15.0	21.9	16.6	24.0	16.8	24.4	16.4	24.7	16.1	25.1	15.6
FXMQ30TBVJU	24.2	20.0	27.6	22.2	30.0	22.4	30.6	21.8	31.0	21.4	31.6	20.8
FXMQ36TBVJU	29.1	22.9	33.0	25.2	36.0	25.7	36.7	25.1	37.2	24.7	37.9	23.9
FXMQ48TBVJU	38.8	30.7	44.1	33.9	48.0	34.8	49.0	33.9	49.7	33.4	50.5	32.2
FXMQ54TBVJU	46.1	36.9	52.5	40.9	57.0	41.8	58.2	40.8	59.1	40.2	59.9	38.6

TC: Total capacity: MBH

SHC: Sensible heat capacity: MBH

Selection results of indoor units

	Room A	Room B	Room C	Room D	Room E	Room F	Room G	Room H
Max. heat load (MBH)	36.1	36.4	17.3	17.3	30.9	30.8	14.1	14.1
Selected IDU	FXMQ48TBVJU	FXMQ48TBVJU	FXMQ18TBVJU	FXMQ18TBVJU	FXMQ36TBVJU	FXMQ36TBVJU	FXMQ15TBVJU	FXMQ15TBVJU
Corrected TC (MBH)	48.0	48.0	18.0	18.0	36.0	36.0	14.2	14.2

* In case of selection based on Total Heat Load and Sensible Heat Load, select indoor units which satisfy not only the Total Heat Load but also the Sensible Heat Load of each room. The sensible heat capacity of indoor units is to be corrected for indoor air temperature. If the design temperature of indoor air falls between temperatures listed in table, calculate sensible heat capacity by using the bypass factor calculated by interpolation for each indoor air temperature.

[3] Selection of outdoor unit

[3] -1 Define the required total heat load from the indoor units to the outdoor unit

Define the required total heat load (A) based on (1) the sum of the peak load of each room or (2) the system peak load.

In this example, select an outdoor unit by (2).

Therefore, (A) = 173.0 MBH

[3] –2 Provisionally select outdoor unit

(1) Calculate CI (Capacity Index) of the selected indoor units.

CI of **VRV** indoor units

CI of FXMQ15TBVJU = 15

CI of FXMQ18TBVJU = 18

CI of FXMQ36TBVJU = 36

CI of FXMQ48TBVJU = 48

Capacity Range		0.5 ton	0.6 ton	0.8 ton	1 ton	1.25 ton	1.5 ton	2 ton	2.5 ton	3 ton	3.5 ton	4 ton	4.5 ton	5 ton	6 ton	8 ton	Power Supply, Standard
Capacity Index		5.8	7.5	9.5	12	15	18	20	24	30	36	42	48	54	60	72	
HSP concealed ducted unit	FXMQ	—	—	—	—	15TB	18TB	—	24TB	30TB	36TB	—	48TB	54TB	—	—	VJU

Calculate the total CI of the indoor units.

Total CI = 15 × 2 + 18 × 2 + 36 × 2 + 48 × 2 = 234

(2) Provisionally select an outdoor unit based on the total CI of the indoor units

The connection ratio of REYQ-XB shall be between 50% (70%: REYQ72XB type) and 130%.

As the total CI of the indoor units is 234, outdoor units from 16 ton to 38 ton are connectable.

Start from 16 ton which is the smallest outdoor unit.

Type	Ton	Capacity index	Model name	Total capacity index of connectable indoor units *1	Maximum number of connectable indoor units	Maximum number of connectable hydrobox
Single outdoor units	6	72	REYQ72XBTJA REYQ72XBYDA REYQ72XBYCA	51 to 93 (144)	12	1
	8	96	REYQ96XBTJA REYQ96XBYDA REYQ96XBYCA	48 to 124 (192)	16	1
	10	120	REYQ120XBTJA REYQ120XBYDA REYQ120XBYCA	60 to 156 (240)	20	2
	12	144	REYQ144XBTJA REYQ144XBYDA REYQ144XBYCA	72 to 187 (288)	25	2
	14	168	REYQ168XBTJA REYQ168XBYDA REYQ168XBYCA	84 to 218 (336)	29	2
Double outdoor units	16	192	REYQ192XBTJA REYQ192XBYDA REYQ192XBYCA	96 to 249 (307)	33	3
	18	216	REYQ216XBTJA REYQ216XBYDA REYQ216XBYCA	108 to 280 (345)	37	3
	20	240	REYQ240XBTJA REYQ240XBYDA REYQ240XBYCA	120 to 312 (384)	41	4
	22	264	REYQ264XBTJA REYQ264XBYDA REYQ264XBYCA	132 to 343 (422)	45	4
	24	288	REYQ288XBTJA REYQ288XBYDA REYQ288XBYCA	144 to 374 (460)	49	4
	26	312	REYQ312XBTJA REYQ312XBYDA REYQ312XBYCA	156 to 405 (499)	54	5
	28	336	REYQ336XBTJA REYQ336XBYDA REYQ336XBYCA	168 to 436 (537)	58	5
Triple outdoor units	30	360	REYQ360XBTJA REYQ360XBYDA REYQ360XBYCA	180 to 468 (468)	62	6
	32	384	REYQ384XBTJA REYQ384XBYDA REYQ384XBYCA	192 to 499 (499)	64	6
	34	408	REYQ408XBTJA REYQ408XBYDA REYQ408XBYCA	204 to 530 (530)	64	6
	36 *2	432	REYQ432XBTJA REYQ432XBYDA REYQ432XBYCA	216 to 561 (561)	64	7
	38	456	REYQ456XBTJA REYQ456XBYDA	228 to 592 (592)	64	7

(3) Confirm that the number of the connected indoor units is within the limitation.

The number of the connected indoor units = 8

The max. number of connectable indoor units of 16 ton outdoor unit = 33

[3] –3 Calculate the corrected capacity of the outdoor unit.

-Calculate the connection ratio of the system.
 Total CI = 234, CI of REYQ192XBYDA = 192
 Connection ratio = 234 / 192 = 122%

-Using the capacity table of the outdoor unit, calculate the capacity (B) corrected for outdoor air temperature, indoor air temperature, and connection ratio.

* In case the outdoor air temperature, the indoor air temperature, or the connection ratio falls between temperatures listed in the table, calculate the capacity by interpolation.

REYQ192XBYDA Cooling Capacity for Standard Condition (Te: 43°F)

Connection ratio	Outdoor air temp.	Indoor air temp. (°FWB)													
		57		61		64		67		70		72		75	
%	°FDB	TC	PI	TC	PI	TC	PI	TC	PI	TC	PI	TC	PI	TC	PI
130	23	146	4.50	188	5.91	219	7.04	250	8.21	271	9.07	275	9.12	281	9.19
	30	146	4.63	188	6.11	219	7.28	250	8.53	265	9.19	269	9.24	275	9.31
	40	146	4.85	188	6.40	219	7.64	250	9.23	256	9.36	260	9.42	266	9.49
	50	146	5.09	188	6.73	219	8.20	242	9.46	248	9.54	251	9.59	257	9.68
	54	146	5.19	188	6.87	219	8.48	238	9.53	244	9.61	248	9.67	254	9.75
	58	146	5.29	188	7.02	219	8.76	235	9.60	241	9.68	245	9.74	250	9.83
	62	146	5.41	188	7.24	219	9.06	231	9.67	237	9.76	241	9.82	247	9.91
	66	146	5.52	188	7.49	219	9.38	228	9.74	234	9.83	238	9.89	243	9.98
	70	146	5.64	188	7.88	219	9.89	224	9.98	230	10.1	234	10.1	240	10.2
	72	146	5.78	188	8.19	217	10.1	223	10.2	229	10.3	232	10.4	238	10.5
	75	146	6.11	188	8.67	214	10.5	220	10.6	226	10.7	230	10.8	236	10.9
	79	146	6.57	188	9.35	211	11.0	217	11.1	222	11.2	226	11.3	232	11.4
	83	146	7.06	188	10.1	207	11.5	213	11.6	219	11.8	223	11.8	229	11.9
	87	146	7.58	188	10.8	204	12.0	210	12.1	216	12.3	219	12.4	225	12.5
	91	146	8.12	188	11.6	200	12.5	206	12.7	212	12.8	216	12.9	219	13.0
	93	146	8.44	188	12.1	199	12.7	205	12.9	210	13.1	214	13.2	215	13.2
	95	146	8.70	188	12.5	197	13.0	203	13.2	209	13.3	210	13.4	210	13.4
	99	146	9.32	188	13.4	194	13.6	199	13.7	202	13.8	202	13.8	202	13.8
103	146	9.98	184	13.9	190	14.1	193	14.2	193	14.2	193	14.2	193	14.2	
106	146	10.6	182	14.5	187	14.6	187	14.6	187	14.6	187	14.6	187	14.6	
110	146	11.6	178	15.3	178	15.3	178	15.3	178	15.3	178	15.3	178	15.3	
115	146	12.9	154	15.4	154	15.5	155	15.5	155	15.5	155	15.5	155	15.5	
118	133	13.0	134	13.1	134	13.1	134	13.1	135	13.1	135	13.1	135	13.1	
122	107	9.89	107	9.91	107	9.93	108	9.95	108	9.96	108	9.97	108	9.99	
120	23	135	4.13	173	5.40	202	6.42	230	7.48	259	8.57	271	9.06	276	9.13
	30	135	4.25	173	5.58	202	6.64	230	7.73	259	9.02	264	9.18	270	9.25
	40	135	4.45	173	5.85	202	6.96	230	8.18	252	9.31	256	9.36	261	9.43
	50	135	4.66	173	6.14	202	7.32	230	8.87	244	9.48	247	9.53	252	9.61
	54	135	4.75	173	6.27	202	7.54	230	9.17	240	9.55	244	9.60	249	9.68
	58	135	4.85	173	6.40	202	7.79	230	9.48	237	9.62	240	9.68	246	9.76
	62	135	4.95	173	6.54	202	8.05	228	9.61	233	9.70	237	9.75	242	9.83
	66	135	5.05	173	6.68	202	8.33	224	9.68	230	9.77	233	9.82	239	9.91
	70	135	5.16	173	7.03	202	8.77	221	9.93	226	10.0	230	10.1	235	10.2
	72	135	5.22	173	7.30	202	9.12	219	10.2	224	10.3	228	10.3	233	10.4
	75	135	5.49	173	7.72	202	9.66	217	10.6	222	10.6	225	10.7	231	10.8
	79	135	5.90	173	8.32	202	10.4	213	11.1	218	11.2	222	11.2	227	11.3
	83	135	6.34	173	8.95	202	11.2	210	11.6	215	11.7	219	11.7	224	11.9
	87	135	6.79	173	9.62	201	12.0	206	12.1	211	12.2	215	12.3	220	12.4
	91	135	7.28	173	10.3	197	12.5	203	12.6	208	12.7	212	12.8	217	12.9
	93	135	7.69	173	10.7	196	12.7	201	12.8	206	13.0	210	13.0	215	13.2
	95	135	7.79	173	11.1	194	13.0	199	13.1	205	13.2	208	13.3	210	13.4
	99	135	8.33	173	11.9	190	13.5	196	13.6	201	13.8	202	13.8	202	13.8
103	135	8.92	173	12.7	187	14.0	192	14.1	193	14.2	193	14.2	193	14.2	
106	135	9.50	173	13.6	184	14.6	187	14.6	187	14.6	187	14.6	187	14.6	
110	135	10.4	173	14.9	178	15.3	178	15.3	178	15.3	178	15.3	178	15.3	
115	135	11.5	154	15.4	154	15.5	155	15.5	155	15.5	155	15.5	155	15.5	
118	133	13.0	134	13.1	134	13.1	134	13.1	135	13.1	135	13.1	135	13.1	
122	107	9.89	107	9.91	107	9.93	108	9.95	108	9.96	108	9.97	108	9.99	

Connection ratio	120%	122%	130%
Cooling capacity	201	(B)	205

(B) = 201 + (205 – 201) × (122 – 120) / (130 – 120) = 201.8

-Confirm capacity correction factor by piping length and level difference (K1)

(K1) = 0.94

1. Rate of change of cooling capacity

Indoor Lower than Outdoor	Vertical pipe length (ft.)	Equivalent Length (ft.)															
		25	66	98	131	164	197	230	262	295	328	361	394	427	460		
	295	-	-	-	-	-	-	-	-	0.89	0.88	0.87	0.86	0.85	0.84		
	262	-	-	-	-	-	-	-	0.91	0.89	0.88	0.87	0.86	0.85	0.84		
	230	-	-	-	-	-	-	0.92	0.91	0.89	0.88	0.87	0.86	0.85	0.84		
	197	-	-	-	-	-	0.94	0.92	0.91	0.90	0.88	0.87	0.86	0.85	0.84		
	164	-	-	-	-	0.96	0.94	0.92	0.91	0.90	0.88	0.87	0.86	0.85	0.84		
	131	-	-	-	0.98	0.96	0.94	0.93	0.91	0.90	0.88	0.87	0.86	0.85	0.84		
	98	-	-	1.00	0.98	0.96	0.94	0.93	0.91	0.90	0.89	0.87	0.86	0.85	0.84		
	66	-	1.00	1.00	0.98	0.96	0.94	0.93	0.91	0.90	0.89	0.87	0.86	0.85	0.84		
	25	1.00	1.00	1.00	0.98	0.96	0.95	0.93	0.92	0.90	0.89	0.88	0.86	0.85	0.84		
FL ±	0	1.00	1.00	1.00	0.98	0.96	0.95	0.93	0.92	0.90	0.89	0.88	0.87	0.85	0.85		
Indoor Higher than Outdoor	25	1.00	1.00	1.00	0.98	0.97	0.95	0.93	0.92	0.90	0.89	0.88	0.87	0.86	0.85		
	66	-	1.00	1.00	0.99	0.97	0.95	0.93	0.92	0.90	0.89	0.88	0.87	0.86	0.85		
	98	-	-	1.00	0.99	0.97	0.95	0.94	0.92	0.91	0.89	0.88	0.87	0.86	0.85		
	131	-	-	-	0.99	0.97	0.95	0.94	0.92	0.91	0.89	0.88	0.87	0.86	0.85		
	164	-	-	-	-	0.97	0.96	0.94	0.92	0.91	0.89	0.88	0.87	0.86	0.85		
	195	-	-	-	-	-	0.96	0.94	0.92	0.91	0.90	0.88	0.87	0.86	0.85		

-Calculate capacity correction factor by piping heat loss (K2)

(K2) = 1 + (heat loss factor per feet of piping × (equivalent piping length – 25 ft.)) / 100

In cooling mode, heat loss factor per feet at 93°F is calculated as below.

(R) Heat loss factor per feet = $0.072^{*2} + (0.098^{*1} - 0.072^{*2}) \times (93^{*3} - 86^{*4}) / (95^{*5} - 86^{*4}) = 0.0922$

Using "Equivalent piping length = 200 ft" and "Heat loss factor per feet = 0.0922",

(K2) = 1 + (0.0922 × (200 – 25)) / 100 = 1.161

Cooling	Ambient temperature								
	41°F	50°F	59°F	68°F	77°F	86°F ^{*4}	93°F ^{*3}	95°F ^{*5}	104°F
Heat loss factor per feet of piping (%)	0.000	0.000	0.013	0.030	0.046	0.072 ^{*2}	(R)	0.098 ^{*1}	0.125

Heating	Ambient temperature							
	5°F	14°F	23°F	32°F	41°F	50°F	59°F	68°F
Heat loss factor per feet of piping (%)	0.328	0.305	0.282	0.256	0.233	0.210	0.187	0.161

-Calculate the corrected capacity of REYQ192XBYDA (C) by using (K1) and (K2).

Corrected capacity of REYQ192XBYDA (C) = (B) × (K1) / (K2) (add defrost correction factor for heating capacity)

Therefore (C) = 201.8 × 0.94 / 1.161 = 163.6 MBH

If the corrected capacity (C) is the same or greater than the required total heat load (A), selection is complete.

If (C) < (A), return to Procedure [3]–2 and provisionally select a larger outdoor unit.

In this example, 163.6 MBH (C) < 173.0 MBH (A), so need to select a larger outdoor unit.

The capacity of REYQ216XBYDA at the same condition is 176.9 MBH, which is more than the heat load (A): 173.0 MBH.

So the selection is complete.

15. Caution Label

15.1 REYQ-XBTJA / XBYDA / XBYCA

REYQ-XBTJA / XBYDA / XBYCA

Service Precautions (1/2) (Touch the noncoated metal part to eliminate static electricity before performing service) (e.g. the control box cover).

CAUTION when performing service inside the control box

⚠ WARNING **⚠ Caution for electric shock**

1. Make sure to turn off the power supply before remove the control box cover. (Touching electric parts may cause electric shock.)
2. Do not open the control box cover for 10 minutes after the power supply is turned off.
3. Measure the voltage between terminals on the terminal block for power supply with a tester and confirm that the power supply is turned off. In addition, measure the points shown below with a tester and confirm that the voltage of the capacitor in the main circuit is less than DC 50V.
4. To prevent a damage of the printed circuit boards, touch the noncoated metal part and make sure to eliminate static electricity before pulling out or plugging in the connector.
5. The work must be started after pulling out the junction connector X1A · X2A · X3A · X4A(X3A X4A are nothing according to the model. Please see wiring diagram for details.) for the fan motor in the outdoor unit and be careful not to touch the energized parts. (If the fan rotates by strong wind, it may cause storage of electricity in the capacitor in the main circuit and electric shock.)
6. After the service is finished, plug in the junction connector.
 - For details, see the wiring diagram label on the back of the control box cover.
 - Otherwise, malfunction code "E7" will be displayed on 7 segment display of outdoor unit printed circuit board (A1P) and in the remote controller due to wrong connection, and normal operation will not be performed.

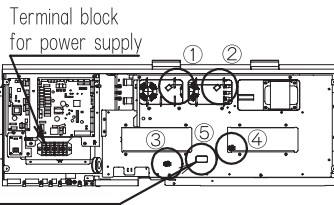
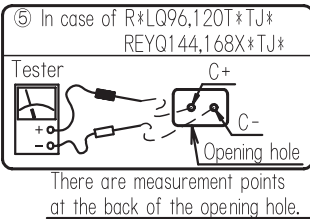

! After service is complete, make sure to close the control box cover. (Water soaking or foreign object may cause failure.)

CAUTION for pi ping work and additional refrigerant charge

- Use the charging hose and gauge manifold designed for R410A in order to withstand the pressure and prevent impurities (such as SUNISO oil) from mixing into.
- Carry out a nitrogen blow when brazing.
- Perform the air tightness and the vacuum drying certainly. (The air tightness test pressure: 550 psi, make sure to use nitrogen gas.)
- Charge the additional refrigerant in liquid state.

CAUTION while check operation

- Make sure to turn on the power supply of all connected units (indoor · BS · outdoor) before operation.
- Make sure to close all outer panels when operating. Otherwise, the system cannot be checked properly.

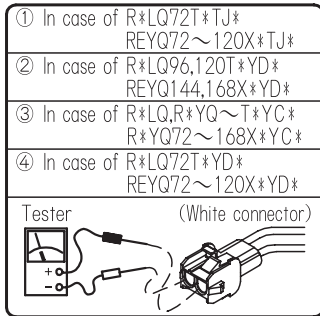

CAUTION for removing and installing the control box cover

[Method of removal]

- ① Remove the 6 screws fixing the cover.
- ② Pull the cover forward.
- ③ Slide the cover downward until the upper tip appears.

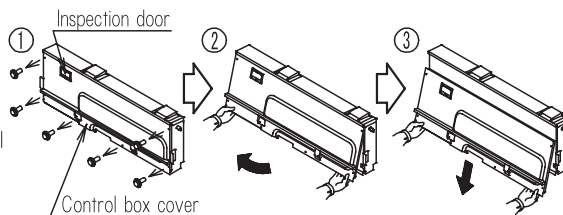

[Method of installation]

For installing the cover, follow the [Method of removal] in the reverse order.

[CAUTION]

- Do not remove the cover by force, if the cover is deformed, water may enter inside, which may cause failure.

 <p>DANGER</p>	<p>ELECTRIC SHOCK HAZARD!</p> <p>DISCONNECT ALL REMOTE POWER SUPPLIES BEFORE INSTALLING OR SERVICING THIS EQUIPMENT.</p> <p>Failure to do so could lead to serious injury or death. Only a qualified service technician should install or service this equipment.</p>	<p>DANGER D' ELECTROCUTION!</p> <p>DÉCONNECTER TOUTES LES ALIMENTATIONS ÉLECTRIQUES ÉLOIGNÉES AVANT D'INSTALLER OU DE REPARER CET APPAREIL.</p> <p>Le non respect de cette recommandation peut entraîner des blessures graves ou la mort. Seul un technicien de service qualifié peut installer ou réparer cet appareil.</p>
--	--	---

Service precautions (2/2)

Field setting

If required, carry out the field setting according to the following instructions. For details, see the service manual.

1. How to operate

- For operating the push button switch, open the inspection door as shown in the below figure with the power supply turned on, and use a resin ballpoint or non-conducting object. After the work is finished, make sure to close the inspection door.

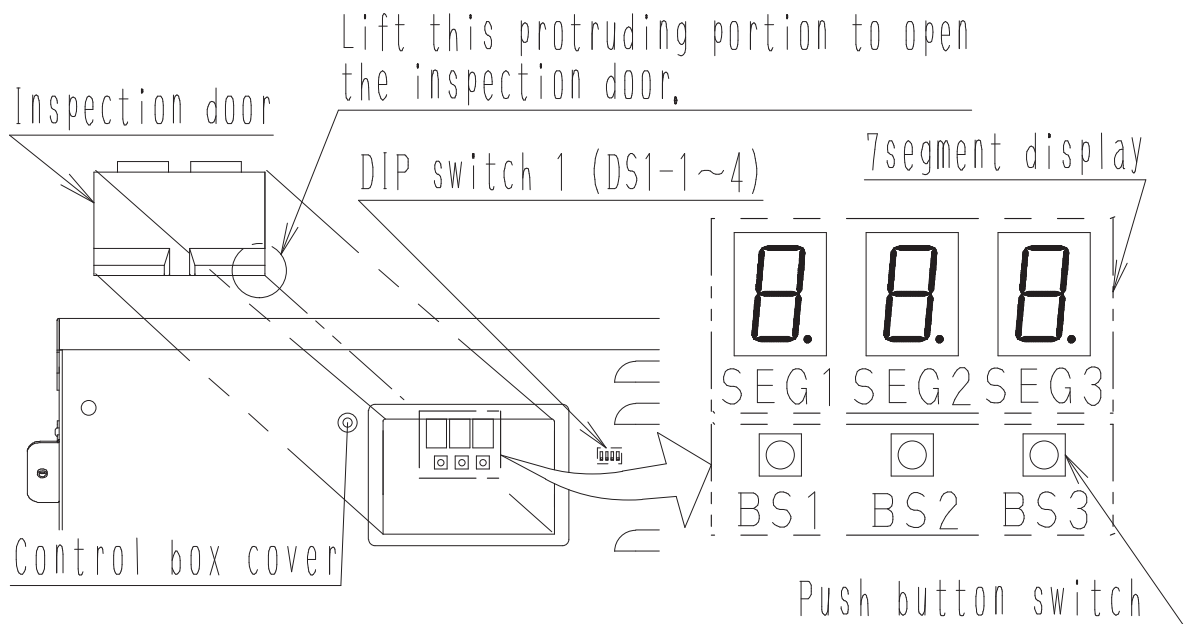

2. Setting by the push button switch (BS1~3)

●Function of the push switch

Push button	Button types	Use
BS1	New page button	For changing setting mode
BS2	Operation button	For changing field setting
BS3	Confirmation button	
BS2 long push	Operation button	For check operation
BS3 long push	Confirmation button	For resetting the address when the wiring is changed or additional indoor unit is installed

●Normal Mode, Setting Mode, Confirmation mode change method

Push new page button (BS1). It can switch confirmation mode, normal mode and setting mode.

[Setting mode] can use for setting (A)~(H) as shown in the right table.

[Confirmation mode] can use for confirmation of (K)•(L) items as shown in the right table.

(Note) About other settings and malfunction codes, see the service manual.

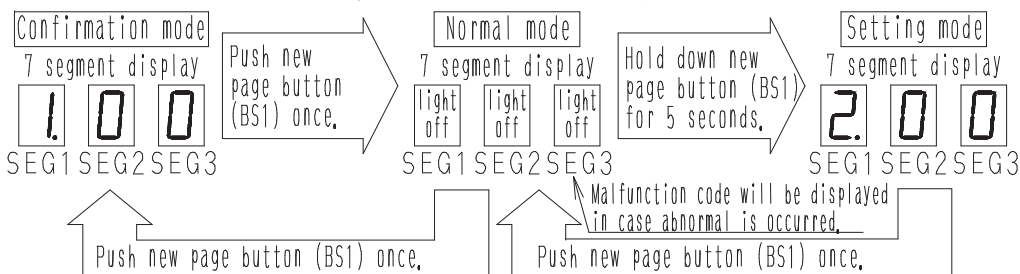

! If you get confused in the setting process, push new page button (BS1), then the system return to initial state (Normal mode).

- For each type setting, make sure to set the master unit. Sub unit setting is invalid.
- Outdoor unit which connect with BS unit (indoor unit) by transmission wiring is master unit, others are sub units.
- Master unit and sub unit can be distinguished by 7 segment display according to operation below.

		7 Segment display			
		SEG1	SEG2	SEG3	
(1)	In [Normal mode], push new page button (BS1) and charge to [Confirmation mode]. Confirm 7 segment display show right description.	1	0	0	
(2)	Push confirmation button(BS3) and confirm the unit master or sub (see right).	Master unit	light off	light off	0
		Sub unit 1	light off	light off	1
		Sub unit 2	light off	light off	2

Set [Setting mode] or [Confirmation mode] first, then perform procedure below.		Details of setting		7 Segment display			
				SEG1	SEG2	SEG3	
Setting procedure	① Push operation button (BS2) and adjust 7 segment display to the required mode shown in right. (*1) For selecting low noise operation or demand operation from outside, or performing cool/heat setting by cool/heat central remote control, external control adapter for outdoor unit (optional accessory) is required. For details, see the instruction attached to the adapter.	Ⓐ Additional refrigerant charge operation setting	2	2	0		
		Ⓑ Refrigerant recovery operation / Evacuation mode setting	2	2	1		
		Ⓒ Night time low noise setting	2	2	2		
		Ⓓ External low noise level setting(*1)	2	2	5		
		Ⓔ Demand level setting(*1)	2	3	0		
		Ⓕ External low noise demand setting (*1)	2	1	2		
		Ⓖ High static pressure setting	2	1	8		
		Ⓗ Year-round cooling (outdoor temp. -4°F(-20°C)) setting (*5)	2	4	5		
		② Push confirmation button (BS3). (The present setting is indicated,)	Either of ③				
		③ Push operation button (BS2) and adjust 7 segment display to required mode shown in right. (*2) Setting level efficiency	For ⒶⒷ ⒻⒼⒽ	ON	light off	light off	1
			OFF (Factory setting)	light off	light off	0	
		For Ⓒ (*2)	OFF (Factory setting)	light off	light off	0	
			Level A (*3) (*3) A is a number of 1~3	light off	light off	A(*3)	
		For Ⓓ (*2)	Level A (*3) (*3) A is a number of 1~3 (Factory setting:2)	light off	light off	A(*3)	
		For Ⓔ (*2)	Level B (*4) (*4) B is number of 1~8 (Factory setting:3)	light off	light off	B(*4)	
	④ Push confirmation button (BS3).	The setting in ③ is defined.			It will turn to light ON.		
	⑤ Push confirmation button again (BS3).	The system start the operation according to the setting.			2	0	0
	⑥ Push new page button (BS1).	The system return to normal mode.			light off	light off	light off
Confirmation procedure	① Push operation button (BS2) according to confirmation item (Ⓚ, Ⓛ) and adjust 7 segment display to the example shown in right according to the required mode.	Ⓚ Low noise operation	1	0	1		
		Ⓛ Demand operation	1	0	2		
	② Push confirmation button (BS3).	During setting operation	light off	light off	1		
	(The present setting will be indicated,)	During normal operation	light off	light off	0		

(*5) Set Ⓗ in case of operating cooling mode in the outdoor temperature 23° (F5°C) or below. This setting is not applicable to BS unit (multi type).

Additional refrigerant charge operation ● When the outdoor unit is stopped and the entire quantity of refrigerant cannot be charged, make sure to charge the remaining quantity of refrigerant using this procedure. If the refrigerant quantity is insufficient, the unit may malfunction.

Setting procedure

- ① Connect the refrigerant charge hose and valve to the stop valve service port on the suction gas side.
- ② Make sure to completely open the stop valve on the suction gas side, the high/low pressure gas side and the liquid side.
- ③ Turn ON the power of the indoor units, BS unit and the outdoor unit. To protect the compressor, make sure to turn on the power supply for 6 hours before starting operation.

- ④ In the state of unit stopped, turn on the additional refrigerant charge operation by **Setting mode**, and open refrigerant cylinder valve. About valve pulse, make sure to adjust refrigerant charging speed as 2.2 lb/minute. The operation is automatically started, 7 segment display will be changed as shown in right(up) and "Test operation" and "Under centralized control" are displayed in the remote controller. Low pressure indication may display on 7 segment display (as shown in right(down)), however, operation can be carried out continuously.

Test operation •
Under centralized control
7 segment display

E 0 1 → **E 0 5**
When start When finish

Example 7 Segment display

0.17MPa ⇒ **0. 1 7**

- ⑤ After charging the specified quantity of refrigerant, close refrigerant cylinder valve, push confirmation button (BS3).
 - The operation will be stopped. The operation is automatically stopped within 30 minutes. If charging is not completed, set and perform the additional refrigerant charging operation again.
 - If the additional refrigerant charging operation is stopped soon, the refrigerant may be overcharged. Stop additional charging and make sure to confirm charged amount again.

Check operation method

! Make sure to open the suction gas side, the high/low pressure gas side and the liquid side stop valve before starting operation.

- For multi system, make sure to confirm setting and result indication by master unit.
- Make sure to carry out the check operation after the first installation. Otherwise, the malfunction code "U3" will be displayed in the remote controller and normal operation cannot be carried.
- The check operation is automatically carried out in a cooling mode. The 7 segment will be indicated as shown in right, and "Test operation" and "Under centralized control" will be displayed in the remote controller.
- During the check operation, it is impossible to stop the unit from the remote controller. When discontinue the operation, push confirmation button (BS3). The system will stop after behind operation for 30 seconds.
- It may takes 5 minutes to bring the state of refrigerant uniform before the compressor starts. Moreover, during the check operation, the refrigerant running sound, or the magnetic sound of a solenoid valve may become loud during operation, but these are not malfunctions.
- The abnormality of each indoor unit and BS unit cannot be checked. After the check operation is finished, check the indoor units individually by normal operation using the remote controller.

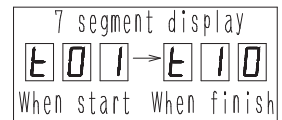

【Operation procedure】

- ① To protect the compressor, make sure to turn on the power supply for 6 hours before starting operation. (After turning on the power supply, the unit cannot start the operation until 7 segment display goes off (maximum 12 minutes).) In the state of unit stopped, set to **Normal mode**.
- ② Push operation button (BS2) for 5 seconds or more. (Then the unit will start the check operation.)
- ③ Close the front panel. (Otherwise, it may cause a wrong judgment.)
- ④ When the checks are completed (unit run for about 40 minutes), the system will stop automatically.
- ⑤ Check the operation results by the outdoor unit 7 segment display. (See the table shown in right.)

Result	7 Segment display
Normally finished	Light off
Abnormally finished	Malfunction code

! Push new page button (BS1) in case taking a wrong operation, then follow procedure since ② again.

【Measure when abnormally finished】

- ① Confirm the malfunction code by the remote controller and 7 segment display, and correct the abnormality. (For how to correct abnormality and correction method, see the installation manual, operation manual and service manual.)
- ② After correcting the abnormality, push confirmation button (BS3) and reset the malfunction code.
- ③ Carry out the check operation again and confirm that the abnormality is properly corrected.

Service mode operation method

- After turning on the power supply, the unit cannot start until 7 segment display goes off for maximum 12 minutes.
- Do not turn off the power and do not reset **Setting mode** when evacuating or recovering the refrigerant. (The expansion valves will close and the system cannot be evacuated or recovered the refrigerant.)

【Evacuation method】 (At the first installation this evacuation is not required. It is only required for service.)

- ① In the state of unit stopped and under **Setting mode**, set the **(B)** refrigerant recovery / evacuation mode. (※)
- ② Evacuate the system with a vacuum pump.
- ③ Push confirmation button (BS3) after finish evacuation and reset the evacuation mode.
- ④ Push new page button (BS1) and reset **Setting mode**.

【Refrigerant recovery operation method】 (Make sure to use a refrigerant reclaimer.)

- ① In the state of unit stopped and under **Setting mode**, set the **(B)** refrigerant recovery / evacuation mode. (※)
- ② Recover the refrigerant by a refrigerant reclaimer.
(For details, see the manual attached in refrigerant reclaimer.)
- ③ After completed, push confirmation button (BS3) and reset the refrigerant recovery mode.
- ④ Push new page button (BS1) and reset **Setting mode**.

(※) The expansion valves in the indoor and outdoor units will be opened completely, 7 segment display will be changed as shown in below and "Test operation" and "Under centralized control" will be displayed in the remote controller. The operation will be rejected.

7 Segment display **E 0 1**

R410A

For those who install or move the unit

1. When lifting the unit

- To hang the unit, use 2 slings of at least 27 ft. long. Put the belt slings into the product openings of foundation legs.
- Put cushioning plates of rags where the slings contact the casing in order to prevent the casing from being damaged.

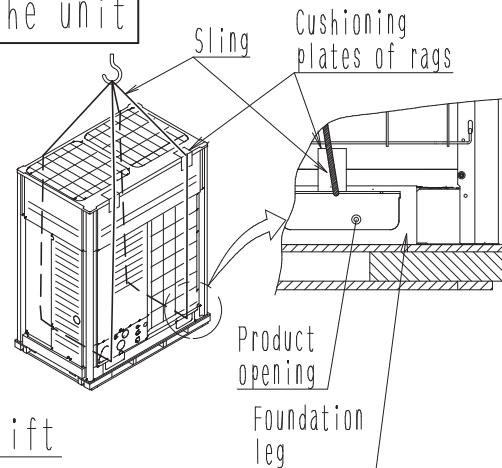

2. When carrying the unit by forklift

- If a forklift is used for carrying the unit, put the fork into wood pallet openings by let the tip out of the opposite side sufficiently.

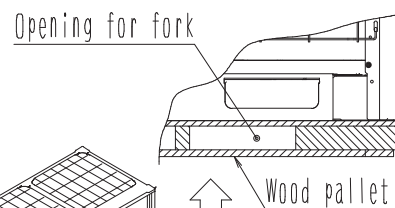

3. Electrical work

- To prevent electric shock and fire accident, be sure to perform grounding and install an earth leak breaker.
- Electrical work must be carried out by a licensed electrician in accordance with local and national regulations.
- Confirm the insulation of main power supply circuit before opening the stop valve. If stop valve remains open without turn on the power supply, insulation resistance may decline due to refrigerant accumulating in compressor.

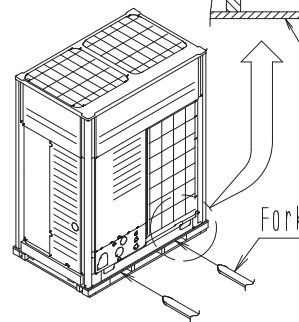

For those who carry out service and maintenance

	WARNING	● Beware of the fan rotating while inspection.
	Caution for electric shock	● Do not touch the energized parts while inspection.

<Front panel (Middle) removing method>

- Pull the front panel (middle) forward to take a hanging lug (bottom) off (①). Remove the panel downward (②).

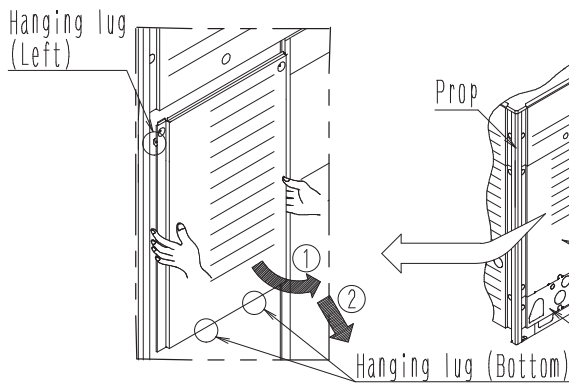

<Front panel (Upper) removing method>

- Lift up the panel a little and take a hanging lug off (①). Remove the panel forward (②).

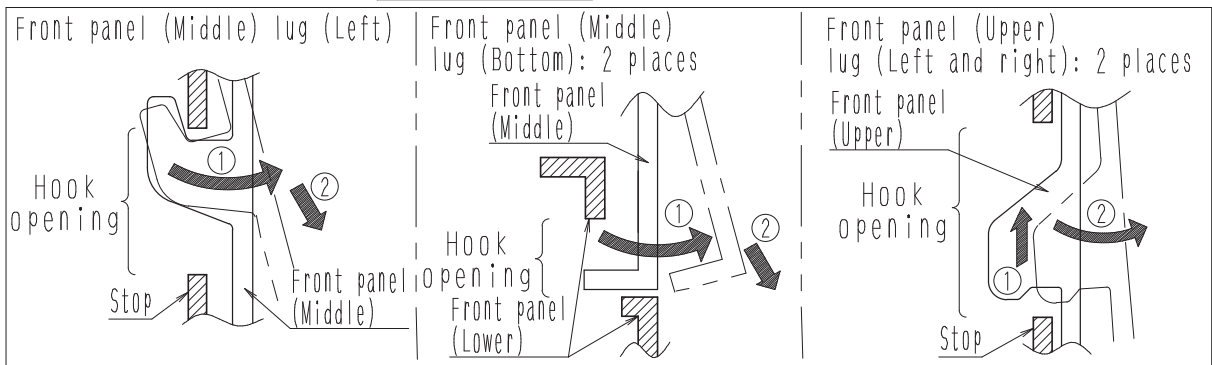
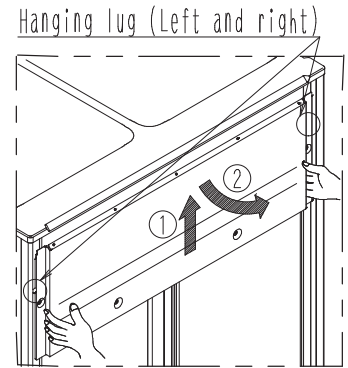

- For the location of the control box and the service ports, see below.

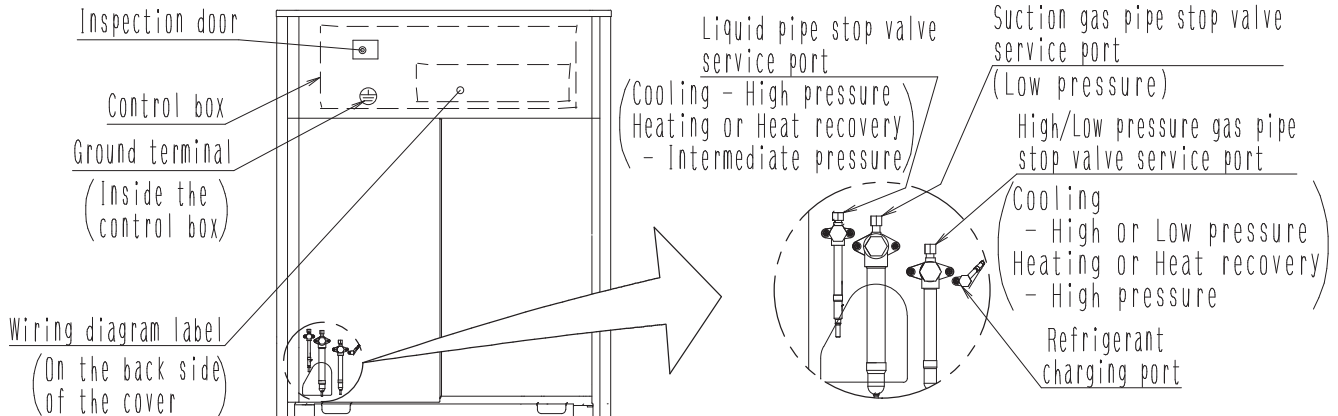

16. Caution for Refrigerant Leaks

16.1 Introduction

The installer and system specialist shall secure safety against leakage according to local regulations or standards. The following standards may be applicable if local regulations are not available.

The VRV System, like other air conditioning systems, uses R410A as refrigerant. R410A itself is an entirely safe non-toxic, non-combustible refrigerant. Nevertheless care must be taken to ensure that air conditioning facilities are installed in a room which is sufficiently large. This assures that the maximum concentration level of refrigerant gas is not exceeded, in the unlikely event of major leak in the system and this in accordance to the local applicable regulations and standards.

Maximum concentration level

The maximum charge of refrigerant and the calculation of the maximum concentration of refrigerant is directly related to the humanly occupied space in to which it could leak.

The unit of measurement of the concentration is lbs./ft.³ (kg/m³) (the weight in lbs. (kg) of the refrigerant gas in 1 ft.³ (1 m³) volume of the occupied space).

Compliance to the local applicable regulations and standards for the maximum allowable concentration level is required.

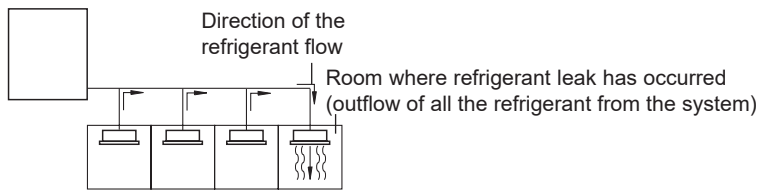

Pay special attention to places, such as basements, etc. where refrigerant could stay, since refrigerant is heavier than air.

3. Specification

16.2 Procedure for Checking Maximum Concentration

Check the maximum concentration level in accordance with steps 1 to 4 below and take whatever action is necessary to comply.

Step 1: Calculate the amount of refrigerant (lbs. (kg)) charged to each system separately.

Amount of refrigerant in a single unit system (amount of refrigerant with which the system is charged before leaving the factory)	+	Additional charging amount (amount of refrigerant added locally in accordance with the length or diameter of the refrigerant piping)	=	Total amount of refrigerant (lbs. (kg)) in the system
---	---	--	---	---



Note:

Where a single refrigerant facility is divided into 2 entirely independent refrigerant systems then use the amount of refrigerant with which each separate system is charged.

Step 2: Calculate the smallest room volume (ft.³(m³))

In case like the following, calculate the volume of (a), (b) as a single room or as the smallest room.

(a) Where there are no smaller room divisions.

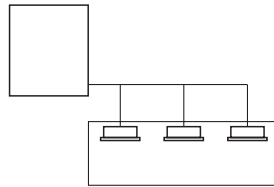

(b) Where there is a room division but there is an opening between the rooms sufficiently large to permit a free flow of air back and forth.

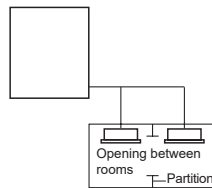

(Where there is an opening without a door or where there are openings above and below the door which are each equivalent in size to 0.15% or more of the floor area.)

(c) Where there is a gas leak detection alarm device linked to a mechanical ventilator in the smallest room then the next smallest room will become the measurement target.

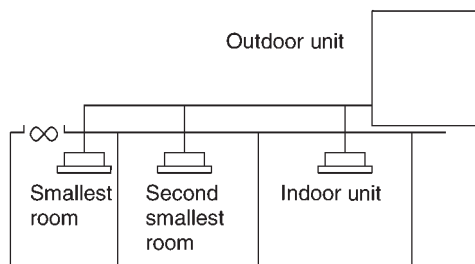

Step 3: Calculating the refrigerant density using the results of the calculations in steps 1 and 2 above.

$$\frac{\text{Total volume of refrigerant in the refrigerant system}}{\text{Size (ft.}^3\text{(m}^3\text{)) of the smallest room in which there is an indoor unit installed}} \leq \text{Maximum concentration level (lbs./ft.}^3\text{(kg/m}^3\text{))}$$

If the result of the above calculation exceeds the maximum concentration level then make similar calculations for the second then third smallest room and so until the result falls short of the maximum concentration.

Step 4: Dealing with the situations where the result exceeds the maximum concentration level.

Where the installation of a facility results in a concentration in excess of the maximum concentration level then it will be necessary to revise the system.

Please consult your Daikin supplier.

17. Safety Devices Setting

FXFQ-AA

Model		FXFQ07AAVJU	FXFQ09AAVJU	FXFQ12AAVJU	FXFQ15AAVJU	FXFQ18AAVJU
Printed circuit board fuse		250 V, 3.15 A	250 V, 3.15 A	250 V, 3.15 A	250 V, 3.15 A	250 V, 3.15 A
Fan motor thermal fuse	°C	—	—	—	—	—
Fan motor thermal protector	°C	—	—	—	—	—
Drain pump fuse	°C	—	—	—	—	—

Model		FXFQ24AAVJU	FXFQ30AAVJU	FXFQ36AAVJU	FXFQ48AAVJU	FXFQ54AAVJU
Printed circuit board fuse		250 V, 3.15 A	250 V, 3.15 A	250 V, 3.15 A	250 V, 3.15 A	250 V, 3.15 A
Fan motor thermal fuse	°C	—	—	—	—	—
Fan motor thermal protector	°C	—	—	—	—	—
Drain pump fuse	°C	—	—	—	—	—

C: 4D140940

FXZQ-TB

Model		FXZQ05TBVJU	FXZQ07TBVJU	FXZQ09TBVJU	FXZQ12TBVJU	FXZQ15TBVJU	FXZQ18TBVJU
Printed circuit board fuse		250 V, 3.15 A	250 V, 3.15 A	250 V, 3.15 A	250 V, 3.15 A	250 V, 3.15 A	250 V, 3.15 A
Fan motor thermal fuse	°F (°C)	—	—	—	—	—	—
Fan motor thermal protector	°F (°C)	—	—	—	—	—	—
Drain pump fuse	°F (°C)	—	—	—	—	—	—

C: 4D137360

FXUQ-PA

Model		FXUQ18PAVJU	FXUQ24PAVJU	FXUQ30PAVJU	FXUQ36PAVJU
Printed circuit board fuse		250 V, 3.15 A	250 V, 3.15 A	250 V, 3.15 A	250 V, 3.15 A
Drain pump thermal fuse	°F (°C)	—	—	—	—
Fan motor thermal protector	°F (°C)	—	—	—	—
Fan motor thermal fuse	°F (°C)	—	—	—	—

C: 3D133254

FXEQ-P

Model		FXEQ07PVJU	FXEQ09PVJU	FXEQ12PVJU	FXEQ15PVJU	FXEQ18PVJU	FXEQ24PVJU
Printed circuit board fuse	A1P	250 V, 3.15 A	250 V, 3.15 A	250 V, 3.15 A	250 V, 3.15 A	250 V, 3.15 A	250 V, 3.15 A
Fan motor thermal protector	°F (°C)	OFF: 223±9 (106±5) ON: 205±27 (96±15)	OFF: 223±9 (106±5) ON: 205±27 (96±15)	OFF: 223±9 (106±5) ON: 205±27 (96±15)	OFF: 223±9 (106±5) ON: 205±27 (96±15)	OFF: 223±9 (106±5) ON: 205±27 (96±15)	OFF: 223±9 (106±5) ON: 205±27 (96±15)

C: 4D098709

FXDQ-M

Model		FXDQ07MVJU	FXDQ09MVJU	FXDQ12MVJU	FXDQ18MVJU	FXDQ24MVJU
Printed circuit board fuse	A1P	250 V, 5 A	250 V, 5 A	250 V, 5 A	250 V, 5 A	250 V, 5 A
Fan motor thermal protector	°F	OFF: 266±9 ON: 181±27	OFF: 266±9 ON: 181±27	OFF: 266±9 ON: 181±27	OFF: 266±9 ON: 181±27	OFF: 266±9 ON: 181±27

C: 3D051758

FXSQ-TB

Model		FXSQ05TBVJU	FXSQ07TBVJU	FXSQ09TBVJU	FXSQ12TBVJU	FXSQ15TBVJU	FXSQ18TBVJU
Printed circuit board fuse		250 V, 3.15 A	250 V, 3.15 A	250 V, 3.15 A	250 V, 3.15 A	250 V, 3.15 A	250 V, 3.15 A
Printed circuit board fuse (fan driver)		250 V, 6.3 A	250 V, 6.3 A	250 V, 6.3 A	250 V, 6.3 A	250 V, 6.3 A	250 V, 6.3 A
Drain pump thermal fuse	°F (°C)	—	—	—	—	—	—

Model		FXSQ24TBVJU	FXSQ30TBVJU	FXSQ36TBVJU	FXSQ48TBVJU	FXSQ54TBVJU
Printed circuit board fuse		250 V, 3.15 A	250 V, 3.15 A	250 V, 3.15 A	250 V, 3.15 A	250 V, 3.15 A
Printed circuit board fuse (fan driver)		250 V, 6.3 A	250 V, 6.3 A	250 V, 6.3 A	250 V, 6.3 A	250 V, 6.3 A
Drain pump thermal fuse	°F (°C)	—	—	—	—	—

C: 3D140708

FXMQ-TB

Model		FXMQ15TBVJU	FXMQ18TBVJU	FXMQ24TBVJU	FXMQ30TBVJU
Printed circuit board fuse		250 V, 3.15 A	250 V, 3.15 A	250 V, 3.15 A	250 V, 3.15 A
Printed circuit board fuse (fan driver)		250 V, 6.3 A	250 V, 6.3 A	250 V, 6.3 A	250 V, 6.3 A
Drain pump thermal fuse	°F (°C)	—	—	—	—

Model		FXMQ36TBVJU	FXMQ48TBVJU	FXMQ54TBVJU
Printed circuit board fuse		250 V, 3.15 A	250 V, 3.15 A	250 V, 3.15 A
Printed circuit board fuse (fan driver)		250 V, 6.3 A	250 V, 6.3 A	250 V, 6.3 A
Drain pump thermal fuse	°F (°C)	—	—	—

C: 3D140811

FXMQ-TA

Model		FXMQ72TAVJU	FXMQ96TAVJU
Printed circuit board fuse		250 V, 5 A	250 V, 5 A
Fan motor thermal fuse	°F	—	—
Fan motor thermal protector	°F	OFF: 275±14 (ON: 189±27)	OFF: 275±14 (ON: 189±27)

FXHQ-M

Model		FXHQ12MVJU	FXHQ24MVJU	FXHQ36MVJU
Printed circuit board fuse		250 V, 5 A	250 V, 5 A	250 V, 5 A
Fan motor thermal fuse	°F	–	–	–
Fan motor thermal protector	°F	OFF: 266±9 ON: 176±36	OFF: 266±9 ON: 176±36	OFF: 266±9 ON: 176±36

C: 3D049334A

FXAQ-P

Model		FXAQ07PVJU	FXAQ09PVJU	FXAQ12PVJU	FXAQ18PVJU	FXAQ24PVJU
Printed circuit board fuse		250 V, 3.15 A	250 V, 3.15 A	250 V, 3.15 A	250 V, 3.15 A	250 V, 3.15 A
Fan motor thermal fuse	°F	–	–	–	–	–
Fan motor thermal protector	°F	–	–	–	–	–

C: 4D047085D

FXLQ-M, FXNQ-M

Model		FXLQ07MVJU FXNQ07MVJU	FXLQ09MVJU FXNQ09MVJU	FXLQ12MVJU FXNQ12MVJU	FXLQ18MVJU FXNQ18MVJU	FXLQ24MVJU FXNQ24MVJU
Printed circuit board fuse		250 V, 5 A	250 V, 5 A	250 V, 5 A	250 V, 5 A	250 V, 5 A
Fan motor thermal protector	°F (°C)	OFF: 275±18 (135±10) ON: 248 (120) or less	OFF: 275±18 (135±10) ON: 248 (120) or less	OFF: 275±18 (135±10) ON: 248 (120) or less	OFF: 275±18 (135±10) ON: 248 (120) or less	OFF: 275±18 (135±10) ON: 248 (120) or less

C: 3D045646B

FXTQ-TB

Model	FXTQ09TBVJUA	FXTQ12TBVJUA	FXTQ18TBVJUA	FXTQ24TBVJUA	FXTQ30TBVJUA
Model (with factory disconnect)	FXTQ09TBVJUD	FXTQ12TBVJUD	FXTQ18TBVJUD	FXTQ24TBVJUD	FXTQ30TBVJUD
Printed circuit board fuse (F1U)	32 V, 3 A	32 V, 3 A	32 V, 3 A	32 V, 3 A	32 V, 3 A
Printed circuit board fuse (F2U)	250 V, 3.15 A	250 V, 3.15 A	250 V, 3.15 A	250 V, 3.15 A	250 V, 3.15 A
Others	Blower motor, Fan driver overload protector				

Model	FXTQ36TBVJUA	FXTQ42TBVJUA	FXTQ48TBVJUA	FXTQ54TBVJUA	FXTQ60TBVJUA
Model (with factory disconnect)	FXTQ36TBVJUD	FXTQ42TBVJUD	FXTQ48TBVJUD	FXTQ54TBVJUD	FXTQ60TBVJUD
Printed circuit board fuse (F1U)	32 V, 3 A	32 V, 3 A	32 V, 3 A	32 V, 3 A	32 V, 3 A
Printed circuit board fuse (F2U)	250 V, 3.15 A	250 V, 3.15 A	250 V, 3.15 A	250 V, 3.15 A	250 V, 3.15 A
Others	Blower motor, Fan driver overload protector				

CXTQ-TA

Model	CXTQ24TASBLU	CXTQ36TASBLU	CXTQ48TASBLU	CXTQ60TASBLU
Printed circuit board fuse (F1U)	32 V, 3 A	32 V, 3 A	32 V, 3 A	32 V, 3 A
Printed circuit board fuse (F2U)	250 V, 3.15 A	250 V, 3.15 A	250 V, 3.15 A	250 V, 3.15 A

4. Appendix

1. Introduction

1.1 ED Book List

Design Manual	REYQ-XB EDUS372349-D (This booklet)
Capacity Table Book		
Heat Recovery	REYQ-XB EDUS372349-C
Installation		
Heat Pump, Heat Recovery.....	RXYQ REYQ EDUS371848A-N
Indoor Units		
Ceiling Mounted Cassette Type (Round Flow with Sensing) ...	FXFQ-AA EDUS392234-F14
VISTA™ 2 × 2 Cassette Unit	FXZQ-TB EDUS392209-F9
4-Way Blow Ceiling-Suspended Type.....	FXUQ-PA EDUS392109-F15
One Way Blow Cassette Type	FXEQ-P EDUS391533A-F16
Slim Ceiling Mounted Duct Type	FXDQ-M EDUS39-600B-F2
MSP Concealed Duct Unit	FXSQ-TB EDUS392235-F17
HSP Concealed Ducted Unit	FXMQ-TB EDUS392236-F4
Ceiling Mounted Duct Type	FXMQ-TA	... ED5VRV2S-NA23V1
Ceiling Suspended Type.....	FXHQ-M EDUS39-600A-F5
Wall Mounted Type.....	FXAQ-P EDUS391100A-F6
Floor Standing Type / Concealed Floor Standing Type	FXLQ-M FXNQ-M EDUS391502A-F7
Air Handling Unit.....	FXTQ-TB	... Engineering Data FXTQ-TB
Cased Coil Unit	CXTQ-TA	... Engineering Data CXTQ-TA
Branch Selector Unit	BSQ-T BSF-Q54T BS-Q54T EDUS392110-B
Air Treatment Equipment		
Outdoor Air Processing Unit	FXMQ-MF EDUS39-900B-F10
Energy Recovery Ventilator.....	VAM-G EDUS711116B
Controls.....	 EDUS721909A-T
Remote Controller		
Navigation Remote Controller.....	BRC1E73 EDUS721438

4. Appendix

1.2 Publication List of Engineering Data for VRV Products

Shaded sections indicate Engineering Data Book/s published for this series.

Timing of publication is subject to change without notice.

Outdoor Unit

Refrigerant	Category	Product series	Type	Volts	Model name	Area	Book category	Book No.	Published in	
R410A	Air cooled	VRV EMERION	H/R	208/230 V 460 V	REYQ-AATJB, AAYDB	USA Canada	Design manual	EDUS372348-D	Feb.2024	
			H/P	208/230 V 460 V	RXYQ-AATJB, AAYDB		USA Canada	Capacity table	EDUS372348-C	Mar.2024
		VRV IV-X	H/R	208/230 V 460 V	REYQ-XBTJA, XBYDA, XBYCA	USA Canada		Design manual	EDUS372349-D	Mar.2024
				575 V			Capacity table	EDUS372349-C	Mar.2024	
			H/P	208/230 V 460 V	RXYQ-XATJA, XAYDA	USA Canada	Design manual	EDUS341923A-D	Oct.2020	
				575 V	RXYQ-XBYCA		Canada	Design manual	EDUS342391-D	Mar.2024
						Capacity table	EDUS342391-C			
		VRV IV	H/R	208/230 V 460 V	REYQ-TATJA, TAYDA	USA Canada	Design manual	EDUS371704C-D	Feb.2020	
				575 V	REYQ-TAYCA		Canada	Design manual		EDUS371706C-D
						Capacity table	EDUS371706C-C			
			H/P	208/230 V 460 V	RXYQ-TATJA, TAYDA	USA Canada	Design manual	EDUS341703B-D		Jan.2020
		575 V		RXYQ-TAYCA	Canada		Design manual	EDUS341824A-D		
						Capacity table	EDUS341703B-C			
						Capacity table	EDUS341824A-C			
		VRV Aurora	H/R	208/230 V 460 V 575 V	RELQ-TBTJA, TBYDA, TBYCA	USA Canada	Design manual	EDUS372352-D	Mar.2024	
			H/P	208/230 V 460 V 575 V	RXLQ-TBTJA, TBYDA, TBYCA		USA Canada	Design manual		EDUS342353-D
								Capacity table	EDUS342353-C	
		VRV IV-S	H/P	208/230 V	RXTQ36TAVJ9A RXTQ48/60TAVJUA	USA Canada	Design manual	EDUS331608C-D	Feb.2020	
								Capacity table		EDUS331608C-C
		VRV LIFE	H/P	208/230 V	RXSQ-TAVJUA	USA Canada	Design manual	EDUS331721A-D	Feb.2020	
							Capacity table	EDUS331721A-C		
			Installation for all VRV air cooled type					Installation	EDUS371848-N	Aug.2019
	Water cooled	VRV-W	H/P	208/230 V 460 V 575 V	RWEQ-TBTJA, TBYDA, TBYCU	USA Canada	Design manual	EDUS302354-D	Mar.2024	
			H/R					Capacity table		EDUS302354-C
		Installation for all VRV water cooled type					Installation	EDUS301864-N	Aug.2019	

Note:

C/O: Cooling only, H/P: Heat pump, H/R: Heat recovery

Indoor Unit and Other Products

Refrigerant	Product category	Product type	Model name	Area	Book No.	Published in	
R410A	VRV Indoor units	Ceiling Mounted Cassette Type (Round Flow with Sensing)	FXFQ07-54AAVJU	USA	EDUS392234-F14	Oct.2023	
		VISTA™ 2 x 2 Cassette Unit	FXZQ05-18TBVJU	USA	EDUS392209-F9	Feb.2022	
		4-Way Blow Ceiling- Suspended Type	FXUQ18-36PAVJU	USA	EDUS392109-F15	Jul.2021	
		One Way Blow Cassette Type	FXEQ07-24PVJU	USA	EDUS391533A-F16	Jan.2021	
		Slim Ceiling Mounted Duct Type	FXDQ07-24MVJU	USA	EDUS39-600A-F2	Mar.2021	
		MSP Concealed Ducted Unit	FXSQ05-54TBVJU	USA	EDUS392235-F17	Oct.2022	
		HSP Concealed Ducted Unit	FXMQ15-54TBVJU	USA	EDUS392236-F4	Oct.2022	
		Ceiling Mounted Duct Type	FXMQ72/96TAVJU	USA	ED5VRV2S-NA23V1	Sep.2023	
		Ceiling Suspended Type	FXHQ12-36MVJU	USA	EDUS39-600A-F5	Mar.2021	
		Wall Mounted Type	FXAQ07-24PVJU	USA	EDUS391100A-F6	Jan.2021	
		Floor Standing Type Concealed Floor Standing Type	FXLQ07-24MVJU FXNQ07-24MVJU	USA	EDUS391502A-F7	Jan.2021	
		Low-temperature hydrobox	HXY48TAVJU	USA	EDUS392021-F18	Sep.2020	
		AHU Integration Kit—Re-Heat	EKEQDCBAV3-US	USA	EDUS392125-F19	Mar.2022	
		Cased Coil Unit	CXTQ24-60TASBLU	USA	Engineering Data CXTQ-TA	—	
		Air Handling Unit	FXTQ09-60TBVJUA FXTQ09-60TBVJUD	USA	Engineering Data FXTQ-TB	—	
		Outdoor Air Processing Unit	FXMQ48-96MFVJU	USA	EDUS39-900B-F10	Mar.2021	
		Branch Selector Unit	BSQ-TAVJ BSF-Q54TVJ BS-Q54TAVJ	USA	EDUS392110-B	Jun.2021	
		Controls and networks	Control systems Control devices Adaptors	Please refer to ED Book with No. on the right for applicable models.	USA	EDUS721909A-T	Oct.2020
	Navigation remote controller		BRC1E73	USA	EDUS721438	Apr.2015	
	intelligent Touch Manager		DCM601A71, DCM601A72	USA	EDUS721212A	Mar.2022	
	intelligent Touch Controller		DCS601C71	USA	EDUS72-608	Dec.2006	
	Interface for use in BACnet®		DMS502B71	USA	EDUS72-749	Oct.2007	
	Option for all type			Please refer to ED Book with No. on the right for applicable models.	USA	OHUS07-1	Nov.2007
	Energy Recovery Ventilator (VAM)			VAM300-1200GVJU	USA	EDUS711116B	Dec.2020

MEMO

MEMO

MEMO

Warning



- Ask a qualified installer or contractor to install this product. Do not try to install the product yourself. Improper installation can result in water or refrigerant leakage, electrical shock, fire or explosion.
- Use only those parts and accessories supplied or specified by Daikin. Ask a qualified installer or contractor to install those parts and accessories. Use of unauthorised parts and accessories or improper installation of parts and accessories can result in water or refrigerant leakage, electrical shock, fire or explosion.
- Read the user's manual carefully before using this product. The user's manual provides important safety instructions and warnings. Be sure to follow these instructions and warnings.

If you have any inquiries, please contact your local importer, distributor and/or retailer.

Cautions on product corrosion

1. Air conditioners should not be installed in areas where corrosive gases, such as acid gas or alkaline gas, are produced.
2. If the outdoor unit is to be installed close to the sea shore, direct exposure to the sea breeze should be avoided. If you need to install the outdoor unit close to the sea shore, contact your local distributor.